

Parts and Features

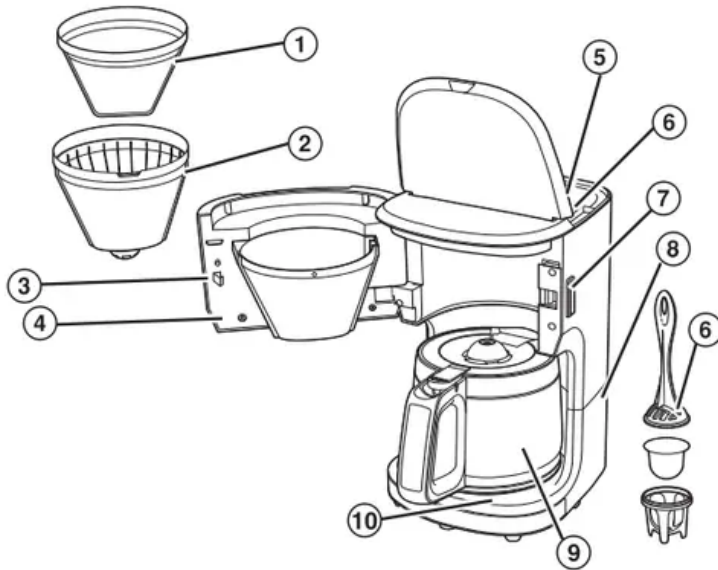

- 1. Removable Gold-Tone Cone Filter Basket (on certain models)
- 2. Removable Filter Basket
- 3. Swing-Out Filter Basket Holder

- 4. Clock and Controls
- 5. Water Reservoir
- 6. Water Filter (on certain models)
- 7. Basket Holder Release Button

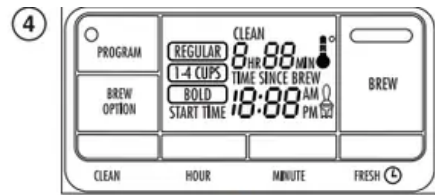

OR



OR

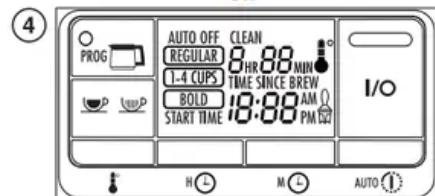

- 8. Cord Storage (in back)
- 9. Carafe (glass or thermal)
- 10. Keep Warm Plate (on certain models)

How to Make Coffee

Before first use: Wash all removable parts in hot, soapy water. Rinse and dry. Brew one cycle with water and discard water.

WARNING Burn Hazard. If filter basket overflow occurs, unplug coffee maker and allow coffee in filter basket to cool before removing filter basket. To avoid hot coffee overflowing from the filter basket:

- The carafe must be replaced within 20 seconds of being removed to prevent overflow.
- Do not exceed the coffee manufacturer's recommended serving amount. See "Troubleshooting."

WARNING Electrical Shock Hazard. Do not immerse cord, plug, or coffee maker in any liquid.

1. Plug into outlet.
2. Press HOUR or H button to set current hour with AM or PM. Press MINUTE or M button to set current minutes.
3. Lift Water Reservoir Lid. Fill with desired amount of water.

4. Press Basket Holder Release Button to open Swing-Out Filter Basket Holder. Add ground coffee. TIP: Add one level tablespoon (5 g) of ground coffee into filter for each cup.
5. Close Swing-Out Filter Basket Holder before brewing, and do not open until brewing cycle is complete and unit is cool.
6. Select your brew option and keep warm settings (see “How to Use the Brew Options and Keep Warm Features”).
7. Press I/ O(On/Off) or BREW button once to turn on Coffee Maker and button will light up. The TIME SINCE BREW freshness timer will come on once the brew cycle begins. It will continue to count up after the brewing is complete and keep your coffee warm until auto shutoff.
8. When all coffee has been served, press I/O (On/Off) or BREW button once and unplug. NOTE: If Coffee Maker is not turned off manually, it will shut off automatically.
9. If storing Coffee Maker, the cord can be pushed into a special Cord Storage area in back of the unit.

For Thermal Carafe Models:

- Rinse Carafe with hot water before making coffee to keep coffee hot longer.
- Coffee Maker will automatically shut off once TIME SINCE BREW freshness timer ends.

How to Program Automatic Brew

NOTE: White LED will come on to indicate PROGRAM is activated and START TIME is displayed. White LED will go off when the unit begins to brew at the preprogrammed time.

1. Press PROG or PROGRAM button until “19:99” flashes. Press HOUR or H and MINUTE or M buttons until desired brewing time is reached.
2. Press and release PROG or PROGRAM button again to activate automatic brew and current time is displayed.

How to Use Brew Options and Keep Warm

Brew Options

Your Coffee Maker will default to the “Regular” strength coffee setting when brewing.

NOTE: Using the brew strength options will increase the length of brewing time slightly.



1. For stronger coffee, hold the BREW OPTION button until “BOLD” comes on; then release.
2. For small amounts, use the 1–4 cup setting by holding BREW OPTION button until “1–4 CUPS” comes on; then release.

3. Press I/ O(On/Off) or BREW button or set the automatic brew to start coffee maker after your brew option has been selected.



Keep Warm (for glass carafe models)

This unit is equipped with an adjustable KEEP WARM temperature and adjustable auto-off feature. It defaults to highest (warmest) temperature setting and 2-hour auto shutoff.

NOTE: If adjusting the Keep Warm temperature after brewing, allow approximately 15 minutes for Coffee Maker to adjust its temperature setting.

1. Adjust Keep Warm temperature by pressing KEEP WARM or  until your desired temperature setting is displayed; then release.
2. Adjust Keep Warm shutoff time by pressing AUTO OFF,  until desired time is displayed. Shutoff time can be set in 10-minute intervals up to 4 hours.
3. To see Auto Off time, press AUTO OFF, . Display will go back to clock time within 5 seconds.
4. Auto Off time can be checked whenever the unit is plugged in. This includes any time during programmed brew, brewing, Keep Warm, and standby mode.

How to Adjust Time Since Brew (for thermal carafe models)

- Press AUTO OFF,  or  until desired time is displayed. Shut off time can be set in 10-minute intervals up to 4 hours. Default setting is 1 hour for thermal carafe models and 2 hours for glass carafe models.

Care and Cleaning

WARNING Electrical Shock Hazard. Do not immerse cord, plug, or coffee maker in any liquid. To remove mineral deposits and buildup: All coffee makers should be cleaned at least once a month (once a week for areas with hard water).

1. Unplug. This resets brew counter for cleaning or water filter notification.
2. Wipe Coffee Maker with a damp cloth or sponge. Dry.
3. Remove Water Filter and filter pod (see “How to Replace Water Filter”).
4. Pour a minimum of 1 pint (2 cups [473 ml]) white vinegar into Water Reservoir.

5. Plug in. Press BREW OPTION button to select CLEAN. “CLEAN” will flash in the display and white LED will come on. Press the I/ (On/Off) or BREW button once. When Clean cycle is finished, wait for unit to cool. Clean cycle takes about 35 minutes to complete.
6. Empty Carafe and rinse. Press BREW OPTION and select REGULAR. Run 2–3 more brew cycles with clean water only. Allow to cool between cycles.
7. Carafe, Gold-Tone Filter, and Removable Filter Basket are dishwasher-safe to wash and dry in the TOP RACK only. DO NOT use the “SANI” setting on dishwasher. “SANI” cycle temperatures could damage your product.

Notifications

Clean Notification

If unit is always plugged in, after 30 cycles “CLEAN” will show in the display. Follow the directions in “Care and Cleaning.”

NOTES:

- Performing the cleaning procedure will clear the display.
- Display will clear automatically after two brews.
- The brew cycle counter resets every time Coffee Maker is unplugged or when power is lost.

Water Filter Notification

-



If Coffee Maker is left plugged in,  will show in the display after 60 cycles. This symbol means that Water Filter should be replaced.

How to Replace Water Filter (optional)

NOTE: For better-tasting coffee, use a water filter.

1. Soak filter pod for 15 minutes in water.
2. Add filter pod to bottom of Water Filter and snap on filter handle.
3. Place assembly into right side of Water Reservoir. NOTE: The brew cycle counter resets every time Coffee Maker is unplugged or when power is lost.

Troubleshooting

1. Filter Basket overflows or coffee brews slowly.
 - The “BOLD” or 1–4 cup brew option is recommended for brewing decaffeinated coffee.

- Excessive amounts of coffee were added to Filter Basket.
- Coffee ground too finely (not automatic drip grind).
- Carafe not securely placed on Keep Warm Plate or Filter Basket Holder not seated correctly.
- Carafe removed during brewing for more than 20 seconds and not placed securely back on Keep Warm Plate.
- Coffee Maker needs cleaning.
- Coffee grounds between filter and Filter Basket.

2. Coffee not brewing/unit will not turn on.

- Water Reservoir is empty.
- Unit is unplugged.
- Power outage.
- Power surge. Unplug; then plug the unit back in.
- Clock requires reset after power outage.

IMPORTANT SAFEGUARDS

When using electrical appliances, basic safety precautions should always be followed to reduce the risk of fire, electric shock, and/or injury to persons, including the following:

1. Read all instructions.
2. This appliance is not intended for use by persons (including children) with reduced physical, sensory, or mental capabilities, or lack of experience and knowledge, unless they are closely supervised and instructed concerning use of the appliance by a person responsible for their safety.
3. Close supervision is necessary when any appliance is used by or near children. Children should be supervised to ensure that they do not play with the appliance.
4. Do not touch hot surfaces. Use handles or knobs. Care must be taken, as burns can occur from touching hot parts or from spilled, hot liquid.
5. To protect against electric shock, do not place cord, plug, or coffee maker in water or other liquid.
6. Unplug from outlet when either the coffee maker or clock is not in use and before cleaning. Allow to cool before putting on or taking off parts and before cleaning the appliance.
7. Coffee maker must be operated on a flat surface away from the edge of counter to prevent accidental tipping.
8. Do not operate any appliance with a damaged supply cord or plug, or after the appliance malfunctions or has been dropped or damaged in any manner. Supply cord replacement

and repairs must be conducted by the manufacturer, its service agent, or similarly qualified persons in order to avoid a hazard. Call the provided customer service number for information on examination, repair, or adjustment.

9. The use of accessory attachments not recommended by the appliance manufacturer may result in fire, electrical shock, or personal injury.
10. Use only the carafe provided with the appliance.
11. Do not use outdoors.
12. Do not let cord hang over edge of table or counter or touch hot surfaces, including stove.
13. The carafe is designed for use with this coffee maker. It must never be used on a range top or in a microwave oven.
14. Do not set a hot carafe on a wet or cold surface.
15. Do not use a cracked carafe or one with a loose or weakened handle.
16. Do not clean carafe with cleansers, steel wool pads, or other abrasive materials.
17. Be certain carafe lid is securely in place during brew cycle and when pouring coffee. Do not use force when placing lid on carafe.
18. Do not place coffee maker on or near a hot gas or electric burner or in a heated oven.
19. To disconnect coffee maker, turn controls to OFF (O) and then remove plug from wall outlet. To unplug, grasp the plug and pull from the outlet. Never pull from the power cord.
20. **WARNING!** To reduce the risk of fire or electric shock, do not remove the bottom cover of the coffee maker. There are no user-serviceable parts inside. Repair should be done by authorized service personnel only.
21. Do not use appliance for other than intended use.
22. Keep warm plate may remain hot after the coffee maker is turned off.
23. Do not place coffee maker in a cabinet when in use.

Other Consumer Safety Information

- This appliance is intended for household use only.
- **WARNING Electrical Shock Hazard:** This appliance is provided with a polarized plug (one wide blade) to reduce the risk of electric shock. The plug fits only one way into a polarized outlet. Do not defeat the safety purpose of the plug by modifying the plug in any way or by using an adapter. If the plug does not fit fully into the outlet, reverse the plug. If it still does not fit, have an electrician replace the outlet.
- The length of the cord used on this appliance was selected to reduce the hazards of becoming tangled in or tripping over a longer cord. If a longer cord is necessary, an approved extension cord may be used. The electrical rating of the extension cord must be equal to or greater than the rating of the appliance. Care must be taken to arrange the

extension cord so that it will not drape over the countertop or tabletop where it can be pulled on by children or accidentally tripped over.

- To avoid an electrical circuit overload, do not use another high-wattage appliance on the same circuit with this appliance.

Carafe Safety Tips



This symbol alerts you to the potential danger for personal injury if you fail to read and follow these safety precautions.



This symbol reminds you that glass is fragile and can break, which could result in personal injury.

- Do not use a cracked Carafe or a Carafe having a loose or weakened handle.
- This Carafe is designed to be used only on the Keep Warm Plate of your Coffee Maker. Do not use on a gas or electric rangetop, or in a microwave or conventional oven.
- To avoid breakage, handle Carafe with care. Avoid impact. Glass will break as a result of impact. Use care when filling with water to avoid hitting faucet.
- Do not place hot Carafe on cool or wet surface. Allow to cool before washing or adding liquids.
- Do not set empty Carafe on a hot heating surface.
- Do not clean with steel wool pads, abrasive cleanser, or any other materials that may scratch.
- Do not place hands inside Carafe. When handling, be careful if wearing any hand jewelry, especially diamond rings. Jewelry can scratch the glass, which increases possibility of breakage.
- Do not bump, scratch, or boil dry.
- Discard Carafe if it is cracked, scratched, or heated while empty for an extended period of time.
- To avoid accidents, do not pour in the direction of people.
- If stirring in the Carafe, use only wooden, plastic, or rubber utensils. Do not use metal utensils.
- Follow the above safety precautions carefully to avoid serious burn injuries which may result if breakage occurs while Carafe holds heated liquids.

Warning

This content is compiled from multiple sources and is provided for reference purposes only. It may not be complete or fully applicable to all situations. If you are unable to resolve your issue, please contact the product manufacturer or an authorized service provider for official support.

Document generated by [ManualsFile](#)