

Operating Instructions

About the features of your microwave oven.

Throughout this manual, features and appearance may vary from your model.

1100 Watts

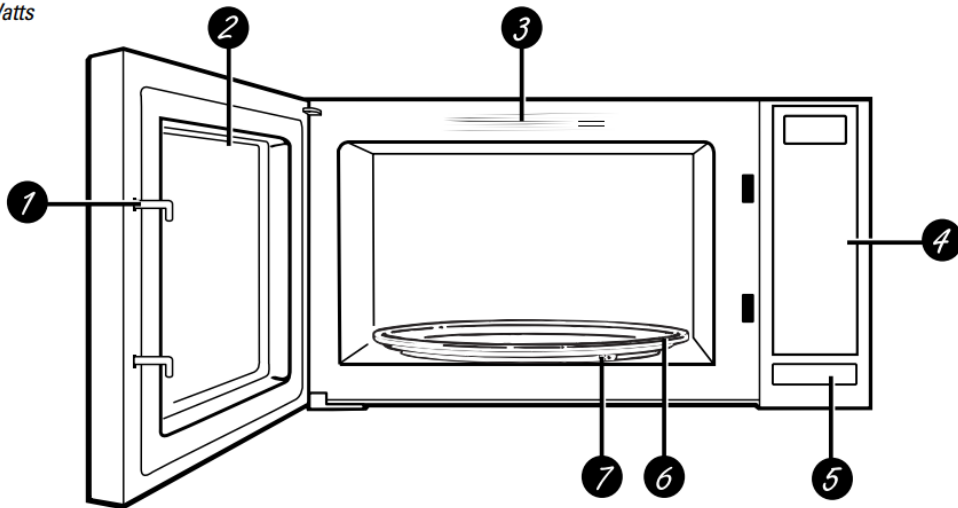

Features of the Oven

1. **Door Latches.**
2. **Window with Metal Shield.** Screen allows cooking to be viewed while keeping microwaves confined in the oven.
3. **Convenience Guide.**
4. **Touch Control Panel Display**
5. **Door Latch Release.** Press latch release to open door.
6. **Removable Turntable.** Turntable and support must be in place when using the oven. The turntable may be removed for cleaning.
7. **Removable Turntable Support.** The turntable support must be in place when using the oven.

You can microwave by time or with the convenience features.

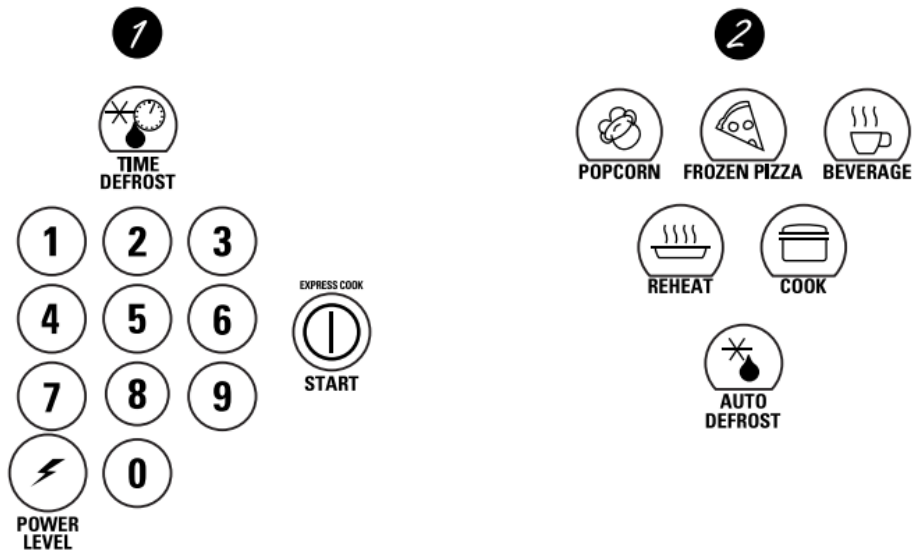

Cooking Controls

1 Time Features

Press	Enter
Time Cook Press number pads	Amount of cooking time
TIME DEFROST	Amount of defrosting time
POWER LEVEL	Power level 0 to HI
EXPRESS COOK	Starts immediately!

About changing the power level

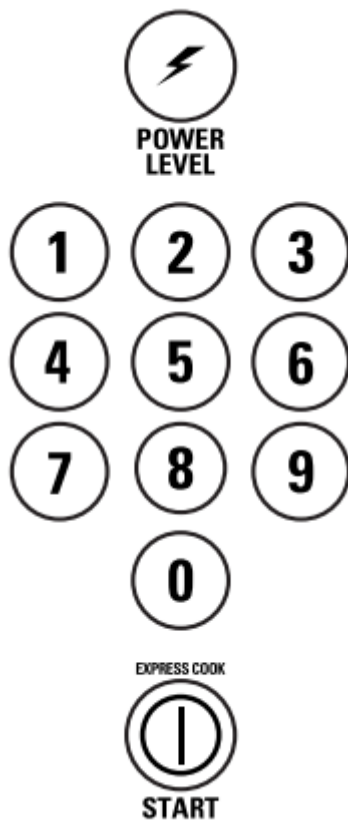

The power level may be entered or changed before entering the time for Time Cook

1. Press POWER LEVEL repeatedly to select power level 0 to HI.
2. Enter cooking time.
3. Press START

Variable power levels add flexibility to microwave cooking. The power levels on the microwave oven can be compared to the surface units on a range. Each power level gives you microwave energy a certain percent of the time. Power level 70 is microwave energy 70% of the time. Power level 30 is energy 30% of the time. Most cooking will be done on HI which gives you 100% power. HI power level will cook faster but food may need more frequent stirring, rotating or turning over. A lower setting will cook more evenly and need less stirring or rotating of the food. Some foods may have better flavor, texture or appearance if one of the lower settings is used. Use a lower power level when cooking foods that have a tendency to boil over, such as scalloped potatoes.

Rest periods (when the microwave energy cycles off) give time for the food to “equalize” or transfer heat to the inside of the food. An example of this is shown with power level 30—the defrost cycle. If microwave energy did not cycle off, the outside of the food would cook before the inside was defrosted.

Here are some examples of uses for various power levels:

HI: Fish, bacon, vegetables, boiling liquids.

Med-High 70: Gentle cooking of meat and poultry; baking casseroles and reheating.

Medium 50: Slow cooking and tenderizing for stews and less tender cuts of meat.

Low 20 or 30: Defrosting; simmering; delicate sauces.

Warm 10: Keeping food warm; softening butter.

About the time features.



Time Cook

Allows you to microwave for any time up to 99 minutes and 99 seconds.

HI power level is automatically set, but you may change it for more flexibility.

1. Change power level if you don't want full power. (Press POWER LEVEL repeatedly to select a desired power level.)
2. Enter cooking time.
3. Press START

You may open the door during Time Cook to check the food. Close the door and press START to resume cooking

Defrosting and Cooking

You can program the oven to automatically begin Time Cook after defrosting.

1. Press AUTO DEFROST and select food weight, or press TIME DEFROST and enter defrosting time.

2. Press POWER LEVEL. Change power level if you don't want full power. (Press POWER LEVEL repeatedly to select a desired power level.)
3. Enter the amount of cooking time.
4. Press START.

The oven will begin defrosting. After defrosting is complete, Time Cook will count down.

	<p>Express Cook</p> <p>This is a quick way to set cooking time for 30 seconds. It will add 30 seconds to the time each time the pad is pressed. The oven will start immediately</p>
---	--

Time Defrost

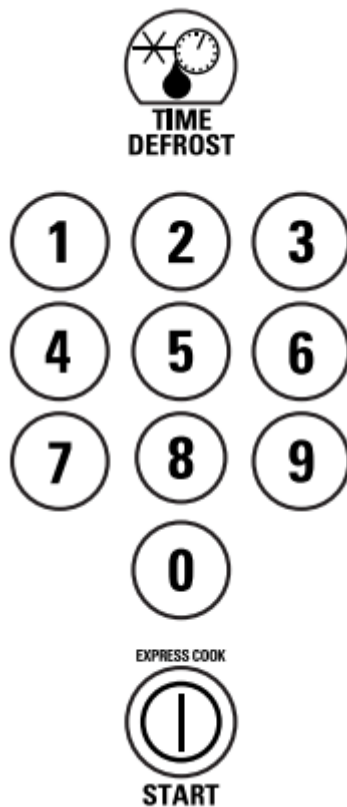

Allows you to defrost for a selected length of time. See the Defrosting Guide for suggested times. (Auto Defrost explained in the About the convenience features section.)

1. Press TIME DEFROST.
2. Enter defrosting time.
3. Press START.

4. Turn the food over after half the time.
5. Press START.

At one half of selected defrosting time, turn food over and break apart or rearrange pieces for more even defrosting. Shield any warm areas with small pieces of foil. The oven will continue to defrost if you don't open the door and turn the food.

A dull thumping noise may be heard during defrosting. This is normal when oven is not operating at HI power.

About the convenience features

Popcorn

 <p><i>Use only with prepackaged microwave popcorn weighing 1.75 to 3.5 ounces.</i></p>	<p>To use the Popcorn feature:</p> <ol style="list-style-type: none"> 1. Follow package instructions, using Time Cook if the package is less than 1.75 ounces or larger than 3.5 ounces. Place the package of popcorn in the center of the microwave. 2. Press POPCORN once for a 3.5 ounce package of popcorn, twice for a 3.0 ounce package or three times for a 1.75 ounce package. The oven starts immediately
--	--

Reheat

	<p>The Reheat feature reheats 12 or 15 ounce servings of many previously cooked foods.</p> <p>Press REHEAT once to select 12 ounces or twice to select 15 ounces. The oven starts immediately</p>
---	---

Beverage

	<p>To use the Beverage feature:</p> <p>Press BEVERAGE once for 1 cup, twice for 2 cups or three times for 3 cups.</p> <p><i>Drinks heated with the Beverage feature may be very hot. Remove the container with care.</i></p>
---	--

Frozen Pizza



To use the Frozen Pizza feature:

1. Follow package instructions, using Time Cook if the pizza is less than 7 ounces or larger than 14 ounces.
2. Press FROZEN PIZZA once for a 7 ounce pizza or twice for a 14 ounce pizza. The oven starts immediately

Cook



EXPRESS COOK



The Cook feature automatically sets the cooking times and power levels for a variety of foods.

1. Press COOK repeatedly to select food type 1–5.
2. Press START

Auto Defrost

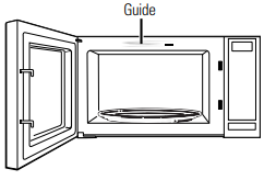
	<p>Use Auto Defrost for meat, poultry and fish weighing up to 2.5 pounds. Use Time Defrost for most other frozen foods.</p> <p>Auto Defrost automatically sets the defrosting times and power levels to give even defrosting results for meats, poultry and fish.</p> <ol style="list-style-type: none"> 1. Press AUTO DEFROST repeatedly to select 1 to 2.5 pounds. 2. Press START <p>(Time Defrost is explained in the About the time features section.)</p>	<p>There is a handy guide located on the inside front of the oven.</p>  <ul style="list-style-type: none"> ■ Remove meat from package and place on microwave-safe dish. ■ When the oven signals, turn the food over. Remove defrosted meat or shield warm areas with small pieces of foil. ■ After defrosting, most meats need to stand 5 minutes to complete defrosting. Large roasts should stand for about 30 minutes.
---	--	---

About the other features

Clock

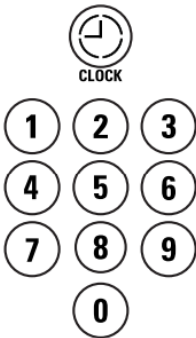
	<p>Press to enter the time of day.</p> <ol style="list-style-type: none"> 1. Press CLOCK once to select 12 hour time or twice to select 24 hour time. 2. Enter time of day. 3. Press CLOCK.
---	--

Pause/Clear



In addition to cancelling selections, PAUSE/CLEAR allows you to stop cooking without opening the door or clearing the display. Press START to restart the oven.

Child Lock-Out



You may lock the control panel to prevent the microwave from being accidentally started or used by children.

To lock or unlock the controls, press and hold PAUSE/CLEAR for about three seconds. When the control panel is locked, the lock indicator will be lit.

Kitchen Timer

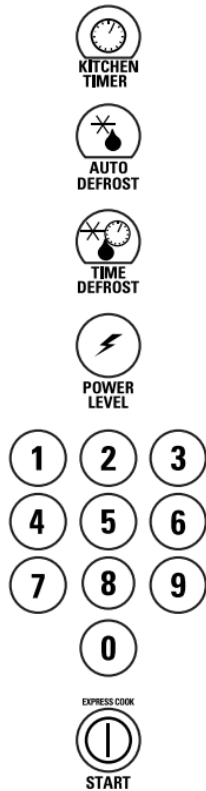

This pad performs three functions:

- It operates as a minute timer.
- It can be set to delay cooking.
- It can be used as a hold setting after defrosting.

How to Use as a Minute Timer

The Kitchen Timer operates without microwave energy.

1. Press KITCHEN TIMER.
2. Enter the amount of time you want to count down.
3. Press START. When the time is up, the timer will signal.

How to Use to Delay the Start of Cooking

You can set the microwave to delay the start of cooking up to 99 minutes and 99 seconds.

1. Press KITCHEN TIMER.
2. Enter the amount of time to delay the start of cooking.
3. Press POWER LEVEL. Change power level if you don't want full power. (Press POWER LEVEL repeatedly to select a desired power level.)
4. Enter the amount of cooking time.
5. Press START

The timer will begin counting down to zero and cooking will then begin.

How to Use to Set a Holding Time

1. Press AUTO DEFROST and select food weight, or press TIME DEFROST and enter defrosting time.
2. Press KITCHEN TIMER.
3. Enter the amount of time you want the oven to hold.
4. Press START

The oven will begin defrosting. After defrosting is complete, the holding time will count down.

Care and cleaning

Helpful Hints



An occasional thorough wiping with a solution of baking soda and water keeps the inside fresh.

Unplug the cord before cleaning any part of this oven.

How to Clean the Inside

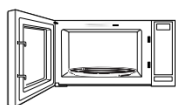

Walls, Floor, Inside Window, Metal and Plastic Parts on the Door

Some spatters can be removed with a paper towel; others may require a damp cloth. Remove greasy spatters with a sudsy cloth, then rinse with a damp cloth. Do not use abrasive cleaners or sharp utensils on oven walls.

To clean the surface of the door and the surface of the oven that come together upon closing, use only mild, nonabrasive soaps or detergents using a sponge or soft cloth. Rinse with a damp cloth and dry.

Never use a commercial oven cleaner on any part of your microwave.

Removable Turntable and Turntable Support

To prevent breakage, do not place the turntable into water just after cooking. Wash it carefully in warm, sudsy water or in the dishwasher. The turntable and support can be broken if dropped. Remember, do not operate the oven without the turntable and support in place.

How to Clean the Outside

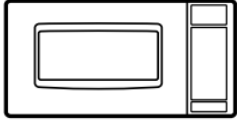

Do not use cleaners containing ammonia or alcohol on the microwave oven. Ammonia or alcohol can damage the appearance of the microwave

Case

Clean the outside of the microwave with a sudsy cloth. Rinse with a damp cloth and then dry. Wipe the window clean with a damp cloth.

Control Panel and Door

Wipe with a damp cloth. Dry thoroughly. Do not use cleaning sprays, large amounts of soap and water, abrasives or sharp objects on the panel—they can damage it. Some paper towels can also scratch the control panel.

Door Surface

It is important to keep the area clean where the door seals against the microwave. Use only mild, non-abrasive detergents applied with a clean sponge or soft cloth. Rinse well.

Power Cord

If the cord becomes soiled, unplug and wash with a damp cloth. For stubborn spots, sudsy water may be used, but be certain to rinse with a damp cloth and dry thoroughly before plugging cord into outlet.

Stainless Steel (on some models)

Do not use a steel-wood pad; it will scratch the surface.

To clean the stainless steel surface, use a hot, damp cloth with a mild detergent suitable for stainless steel surfaces. Use a clean, hot, damp cloth to remove soap. Dry with a dry, clean cloth. Always scrub lightly in the direction of the grain.

Troubleshooting Tips

Problem	Possible Causes	What To Do
Oven will not start	A fuse in your home may be blown or the circuit breaker tripped	•Replace fuse or reset circuit breaker
	Power surge.	•Unplug the microwave oven, then plug it back in.
	Plug not fully inserted into wall outlet	•Make sure the 3-prong plug on the oven is fully inserted into wall outlet.
	Door not securely closed.	•Open the door and close securely.
Control panel lighted, yet oven will not start	Door not securely closed.	•Open the door and close securely
	START pad not pressed after entering cooking selection.	•Press START.
	Another selection entered already in oven and PAUSE/CLEAR pad not pressed to cancel it.	•Press PAUSE/CLEAR.
	PAUSE/CLEAR was pressed accidentally	•Reset cooking program and press START.
Microwave oven control will not work	The control has been locked. (When the control panel is locked, the lock indicator will be lit.)	• Press and hold PAUSE/CLEAR for about three seconds to unlock the control.

Things That Are Normal With Your Microwave Oven

- Steam or vapor escaping from around the door.
- Light reflection around door or outer case.
- Dimming oven light and change in the blower sound at power levels other than high.
- Dull thumping sound while oven is operating

- TV/radio interference might be noticed while using the microwave. Similar to the interference caused by other small appliances, it does not indicate a problem with the microwave. Plug the microwave into a different electrical circuit, move the radio or TVs far away from the microwave as possible, or check the position and signal of the TV/radio antenna.

Warning

This content is compiled from multiple sources and is provided for reference purposes only. It may not be complete or fully applicable to all situations. If you are unable to resolve your issue, please contact the product manufacturer or an authorized service provider for official support.