

## Operating Instructions

### Using the gas surface burners.

Throughout this manual, features and appearance may vary from your model.

#### How to Light a Gas Surface Burner

Push the control knob in and turn it to the LITE position.

You will hear a little clicking noise—the sound of the electric spark igniting the burner.

After the flame lights, turn the knob to adjust the flame size. If the knob stays at LITE, it will continue to click.

When one burner is turned to LITE, all the burners spark. Do not attempt to disassemble or clean around any burner while another burner is on. An electric shock may result, which could cause you to knock over hot cookware.

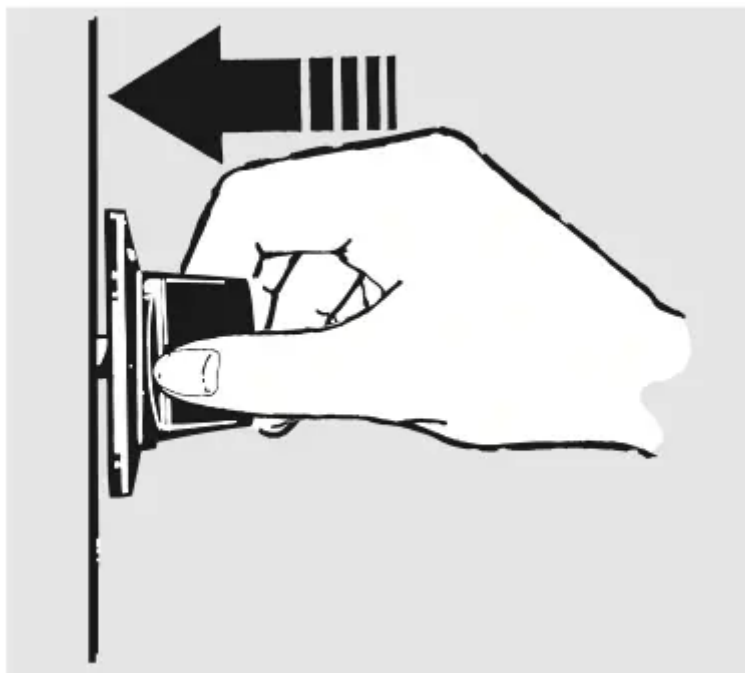

Push the control knob in and turn it to the LITE position.

#### Sealed Gas Burners

The smaller burner (right rear position) will give the best simmer results for delicate foods, such as sauces or foods which need to cook over low heat for a long time. It can be turned down to a very low setting.

The largest burners are higher powered than the others and will bring liquids to a boil quicker.

#### How to Select Flame Size

For safe handling of cookware, never let the flames extend up the sides of the cookware.

Watch the flame, not the knob, as you reduce heat. The flame size on a gas burner should match the cookware you are using.

Any flame larger than the bottom of the cookware is wasted and only serves to heat the handle.

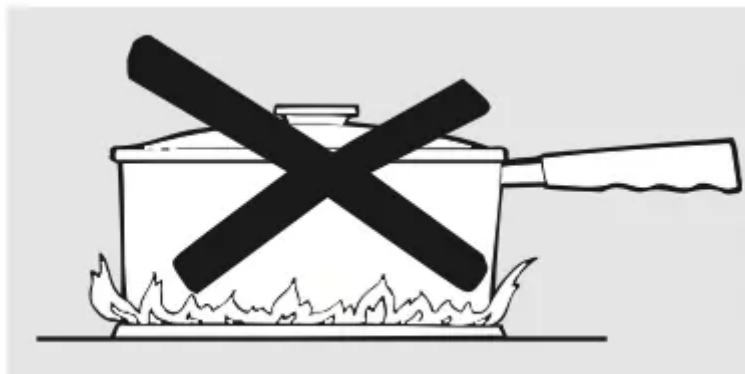

### **In Case of Power Failure**

In case of a power failure, you can light the gas surface burners on your range with a match. Hold a lit match to the burner, then push in and turn the control knob to the LITE position. Use extreme caution when lighting burners this way.

Surface burners in use when an electrical power failure occurs will continue to operate normally.

### **Before Lighting a Gas Burner**

- Make sure all grates on the range are in place before using any burner.

### **After Lighting a Gas Burner**

- Do not operate the burner for an extended period of time without cookware on the grate. The finish on the grate may chip without cookware to absorb the heat.
- Be sure the burners and grates are cool before you place your hand, a pot holder, cleaning cloths or other materials on them.

### **Top-of-Range Cookware**

**Aluminum:** Medium-weight cookware is recommended because it heats quickly and evenly. Most foods brown evenly in an aluminum skillet. Use saucepans with tightfitting lids when cooking with minimum amounts of water.

**Cast-Iron:** If heated slowly, most skillets will give satisfactory results.

**Enamelware:** Under some conditions, the enamel of some cookware may melt. Follow cookware manufacturer's recommendations for cooking methods.

**Glass:** There are two types of glass cookware—those for oven use only and those for top-of-range cooking (saucepans, coffee and teapots). Glass conducts heat very slowly.

**Heatproof Glass Ceramic:** Can be used for either surface or oven cooking. It conducts heat very slowly and cools very slowly. Check cookware manufacturer's directions to be sure it can be used on gas ranges.

**Stainless Steel:** This metal alone has poor heating properties and is usually combined with copper, aluminum or other metals for improved heat distribution. Combination metal skillets usually work satisfactorily if they are used with medium heat as the manufacturer recommends.

### Stove Top Grills

Do not use stove top grills on your sealed gas burners. If you use the stove top grill on the sealed gas burner, it will cause incomplete combustion and can result in exposure to carbon monoxide levels above allowable current standards.

This can be hazardous to your health.



### Wok This Way

We recommend that you use a 14-inch or smaller flat-bottomed wok. They are available at your local retail store. Make sure the wok bottom sits flat on the grate.

Only a flat-bottomed wok should be used.

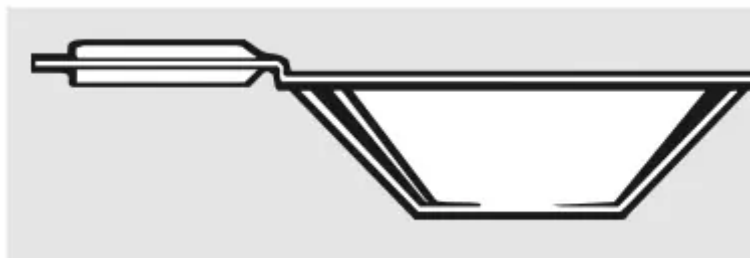

Use a flat-bottomed wok.

Do not use a round-bottomed wok on a support ring. Placing the ring over the burner or grate may cause the burner to work improperly, resulting in carbon monoxide levels above allowable standards. This could be dangerous to your health.



## Using the oven controls.

Throughout this manual, features and appearance may vary from your model.

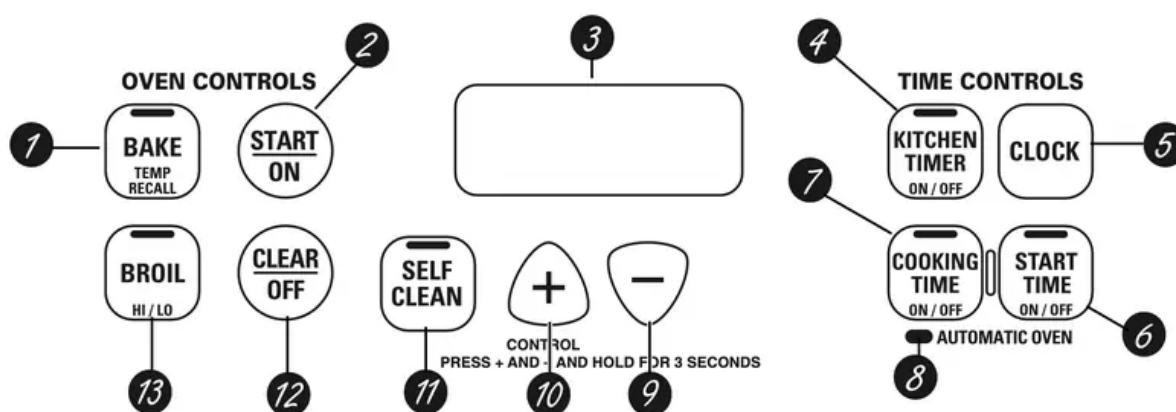

## Oven Control, Clock and Timer Features and Settings

### 1. BAKE/TEMP RECALL Pad

Touch this pad to select the bake function.

#### BAKE Light

Flashes while in edit mode—you can change the oven temperature at this point. Glows when the oven is in bake mode.

### 2. START/ON Pad

Must be touched to start any cooking or cleaning function.

### 3. Display

Shows the time of day, oven temperature, whether the oven is in the bake, broil or selfcleaning mode and the times set for the timer or automatic oven operations. The display will show “PrE” while preheating. When the oven reaches the selected temperature, the oven control will beep and the display will show the oven temperature.

#### Function Error Code

If “F– and a number or letter” flash in the display and the oven control signals, this indicates a function error code.

If the function error code appears during the selfcleaning cycle, check the oven door latch. The latch handle may have been moved, even if only slightly, from the latched position. Make sure the latch is moved to the right as far as it will go.

Touch the CLEAR/OFF pad. Allow the oven to cool for one hour. Put the oven back into operation. If the function error code repeats, disconnect the power to the range and call for service.

#### 4. **KITCHEN TIMER ON/OFF Pad**

Touch this pad to select the timer feature.

Then press + and – pads to adjust time.

##### **TIMER Light**

Flashes while in edit mode—you can change the set time at this point. Glows when the timer has been activated. Flashes again when the time has run out until the control is reset.

#### 5. **CLOCK Pad**

To set clock, touch this pad twice and then touch the + and – pads. The time of day will flash in display when oven is first turned on.

#### 6. **START TIME Pad**

Use along with the COOKING TIME or SELF CLEAN pads to set the oven to start and stop automatically at a time you set.

##### **START TIME Time Light**

Flashes while in edit mode—you can change the start time set time at this point. Glows when the function has been activated.

#### 7. **COOKING TIME Pad**

Touch this pad and then touch the + or – pads to set the amount of time you want your food to cook. The oven will shut off when the cooking time has run out.

##### **COOKING TIME Light**

Flashes while in edit mode—you can change set time at this point. Glows when function has been activated. Flashes again when the time has run out until the control is reset.

#### 8. **AUTOMATIC OVEN Light**

This lights anytime the oven has been programmed using the COOKING TIME or START TIME functions.

#### 9. **– Pad**

Short taps to this pad will decrease the time or temperature by small amounts. Touch and hold the pad to decrease the time or temperature by larger amounts.

#### 10. **+ Pad**

Short taps to this pad will increase the time or temperature by small amounts. Touch and hold the pad to increase the time or temperature by larger amounts.

#### 11. **SELF CLEAN Pad**

Touch this pad to select the self-cleaning function. See the Using the self-cleaning oven

section.

### **CLEAN Light**

Flashes while in edit mode—you can change the length of time for the self-clean cycle at this point. Glows when the oven is in the self-clean cycle. After the self-clean cycle, the light will turn off. Unlatch the door.

### 12. **CLEAR/OFF Pad**

Touch this pad to cancel ALL oven operations except the clock and timer.

### 13. **BROIL HI/LO Pad**

Touch this pad to select the broil function.

### **BROIL Light**

Flashes while in edit mode—you can switch from HI to LO BROIL at this point. Glows when the oven is in broil mode.

Indicator Lights (on some pads)

EDIT mode lasts several seconds after the last pad press. START TIME ON/OFF and COOKING TIME ON/OFF will be the only pads lit if either of these options is selected.

(Example: START TIME is selected with BAKE—the START TIME pad will remain lit until the clock reaches the programmed time, at which point it will turn off and the BAKE/TEMP RECALL pad light will light up).

## **Control Lockout**

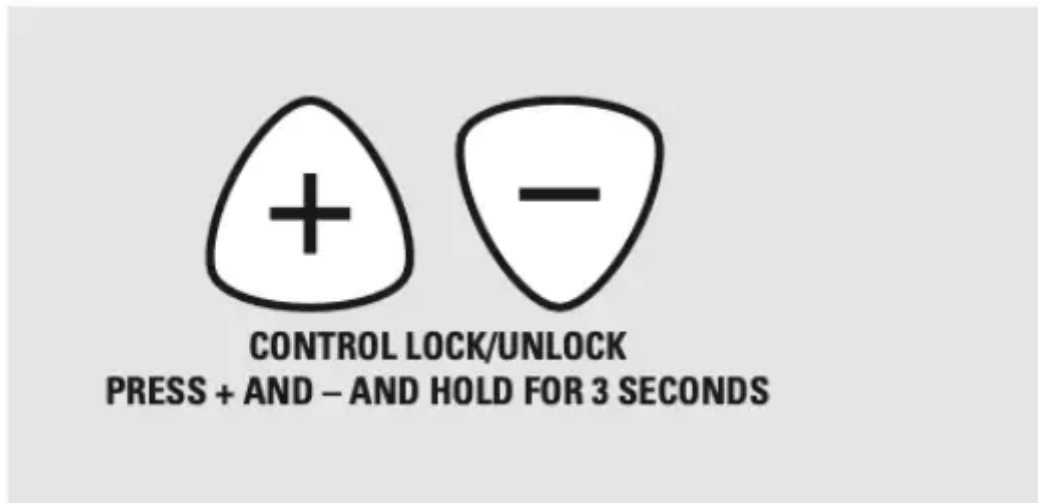

Your control will allow you to lock out the touch pads so they cannot be activated when touched.

### **To lock/unlock the controls:**

1. Touch the + and – pads at the same time for 3 seconds, until the display shows LOC ON.
2. To unlock the control, touch the + and – pads at the same time for 3 seconds, until the display shows LOC OFF.

When this feature is on and the touch pads are touched, the control will beep and the display will show LOC ON.

- The control lockout mode affects all touch pads. No touch pads will work when this feature is activated.
- The adjustment will be retained in memory after a power failure.

## **Power Outage**

**CAUTION:** Do not make any attempt to operate the electric ignition oven during an electrical power failure.

The oven or broiler cannot be lit during a power failure. Gas will not flow unless the glow bar is hot.

If the oven is in use when a power failure occurs, the oven burner shuts off and cannot be re-lit until power is restored. This is because the flow of gas is automatically stopped and will not resume when power is restored until the glow bar has reached operating temperature.

If a flashing time is in the display, electric power has been restored. Reset the clock.

If your oven was set for a timed oven operation and a power outage occurred, the clock and all programmed functions must be reset.

To reset the clock, touch the CLOCK pad. Enter the correct time of day by touching the + or – pads. Touch the START/ON pad.

## **Using the oven**

To avoid possible burns, place the racks in the desired position before you turn the oven on.

### **Before you begin...**

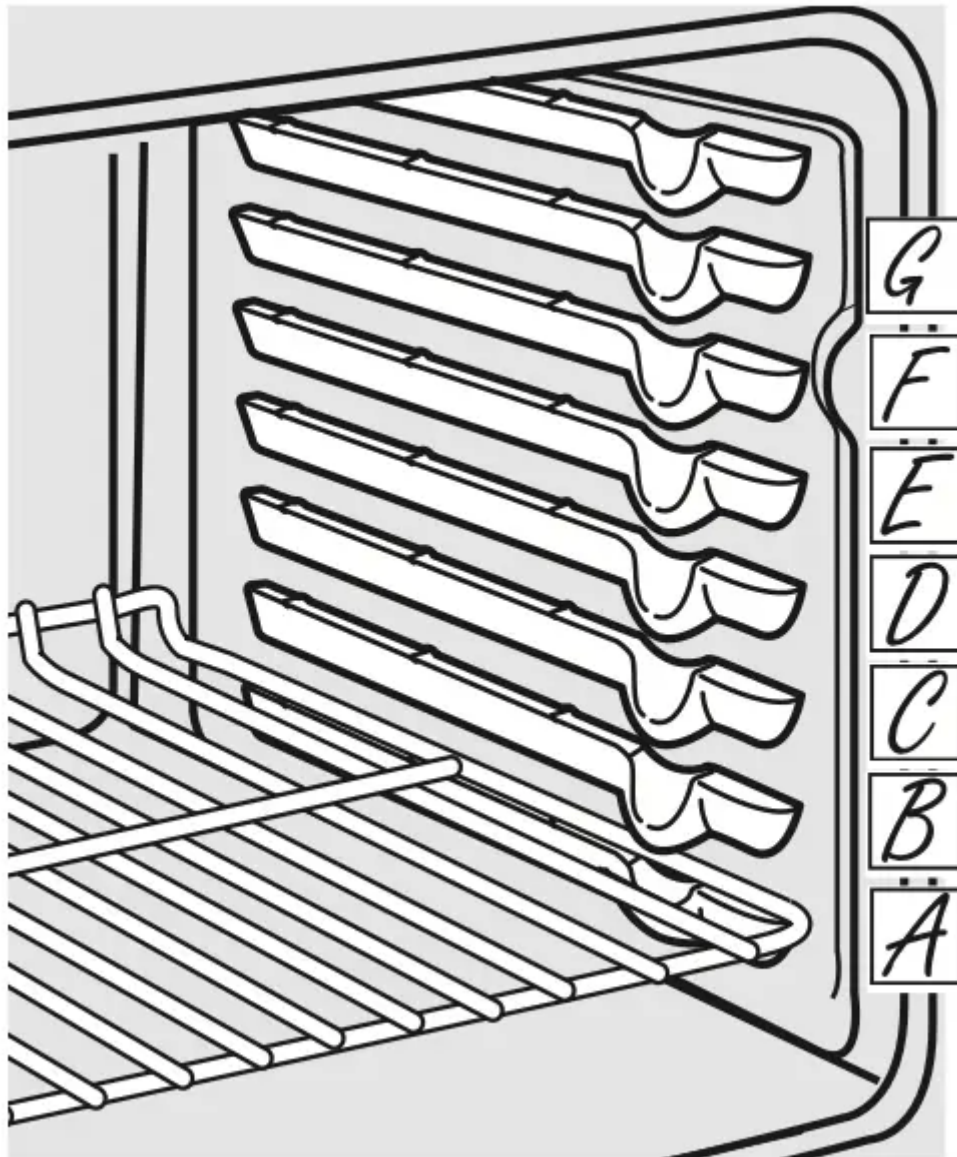

The racks have stops, so that when placed correctly on the supports, they will stop before coming completely out, and will not tilt.

When placing and removing cookware, pull the rack out until it stops.

The bake burner is under the oven floor. Do not place foods on the oven bottom for cooking.

To remove a rack, pull it toward you, tilt the front end up and pull it out.

To replace, place the end of the rack (stoplocks) on the support, tilt up the front and push the rack in.

**CAUTION:** When you are using the rack in the lowest position (A), you will need to use caution when pulling the rack out. We recommend that you pull the rack out several inches and then, using two pot holders, pull the rack out by holding the sides of it. The rack is low and you could be burned if you place your hand in the middle of the rack and pull all the way out. Be very careful not to burn your hand on the door when using the rack in the lowest position (A).

### How to Set the Oven for Baking or Roasting



1. Touch the BAKE pad.

2. Touch the + or – pads until the desired temperature is displayed.

3. Touch the START/ON pad.

The oven will start automatically. The display will show “PrE” while preheating. When the oven reaches the selected temperature, the oven control will beep several times and the display will show the oven temperature.

To change the oven temperature during BAKE cycle, touch the BAKE pad and then the + or – pads to get the new temperature.

4. Check food for doneness at minimum time on recipe. Cook longer if necessary.

5. Touch the CLEAR/OFF pad when baking is finished and then remove the food from the oven.

**NOTE:** A cooling fan will automatically turn on and off to cool internal parts. This is normal, and the fan may continue to run even after the oven is turned off.

Type of Food	Rack Position
Frozen pies (on cookie sheet)	C or D
Angel food cake	A
Bundt or pound cakes	B or C
Biscuits, muffins, brownies, cookies, cupcakes, layer cakes, pies	C or D
Casseroles	C or D
Turkey	A

If baking four cake layers at the same time, place two layers on rack B and two layers on rack D. Stagger pans on the rack so one is not directly above the other.

#### Preheating and Pan Placement

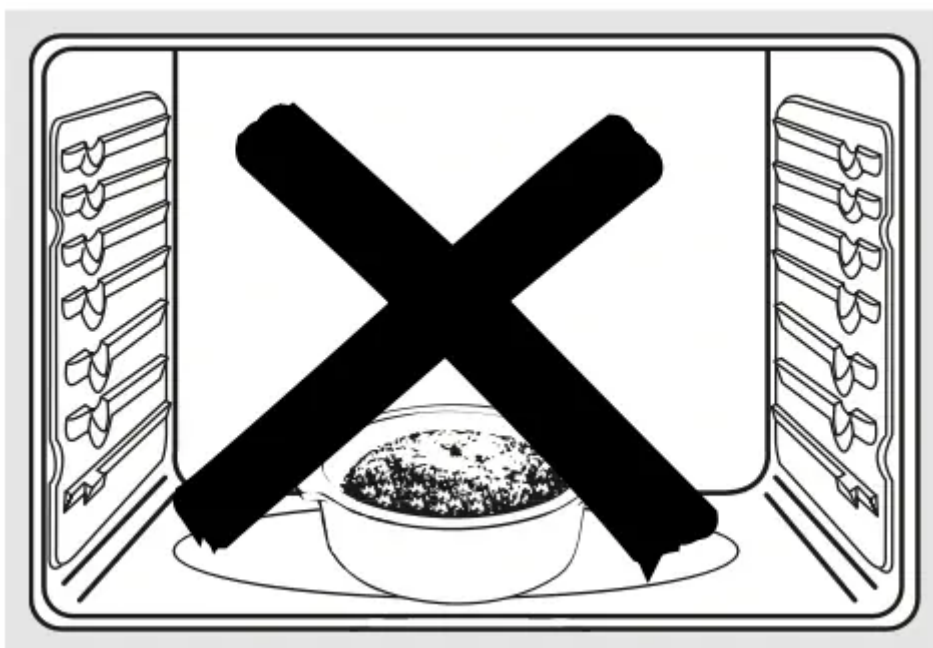

Preheat the oven if the recipe calls for it. Preheating is necessary for good results when baking cakes, cookies, pastry and breads.

To preheat, set the oven at the correct temperature. The control will beep when the oven is preheated and the display will show your set temperature. The preheat time will vary depending on the temperature setting.

Baking results will be better if baking pans are centered in the oven as much as possible. If baking with more than one pan, place the pans so each has at least 1" to 1½" of air space around it.

### **Aluminum Foil**

Do not use aluminum foil to line oven bottoms. The foil will trap heat below and upset the performance of the oven. Foil can melt and permanently damage the oven bottom. Damage from improper use of aluminum foil is not covered by the product warranty.

Foil may be used to catch spills by placing a sheet on a lower rack, several inches below the food. Do not use more foil than necessary and never entirely cover an oven rack with aluminum foil. Keep foil at least 1-1/2" from oven walls to prevent poor heat circulation.

### **Oven Moisture**

As your oven heats up, the temperature change of the air in the oven may cause water droplets to form on the door glass. These droplets are harmless and will evaporate as the oven continues to heat up.

### **Oven Vent**

Your oven is vented through the rear vent located through the cooktop under the vent grille. Do not block this vent when cooking in the oven—it is important that the flow of hot air from the oven and fresh air to the oven burner be uninterrupted. Avoid touching the vent openings or nearby surfaces during oven or broiler operation—they may become hot.

- Handles of pots and pans on the cooktop may become hot if left too close to the vent.
- Do not leave plastic items on the cooktop—they may melt if left too close to the vent.
- Do not leave any items on the cooktop. The hot air from the vent may ignite flammable items and will increase pressure in closed containers, which may cause them to burst.
- Metal items will become very hot if they are left on the cooktop, and could cause burns.

### **How to Set the Oven for Broiling**

**IMPORTANT:** To avoid possible burns, place the racks in the desired position before you turn the oven on.

1. Place the meat or fish on a broiler grid in a broiler pan designed for broiling.
2. Follow suggested rack positions in the Broiling Guide.
3. The oven door must be closed during broiling.

4. Touch the BROIL HI/LO pad once for HI Broil.  
To change to LO Broil, touch the BROIL HI/LO pad again.  
Use LO Broil to cook foods such as poultry or thick cuts of meat thoroughly without over-browning them.
5. Touch the START/ON pad.
6. When broiling is finished, touch the CLEAR/OFF pad.  
Serve the food immediately, and leave the pan outside the oven to cool during the meal for easiest cleaning.

The size, weight, thickness, starting temperature and your preference of doneness will affect broiling times. This guide is based on meats at refrigerator temperature.

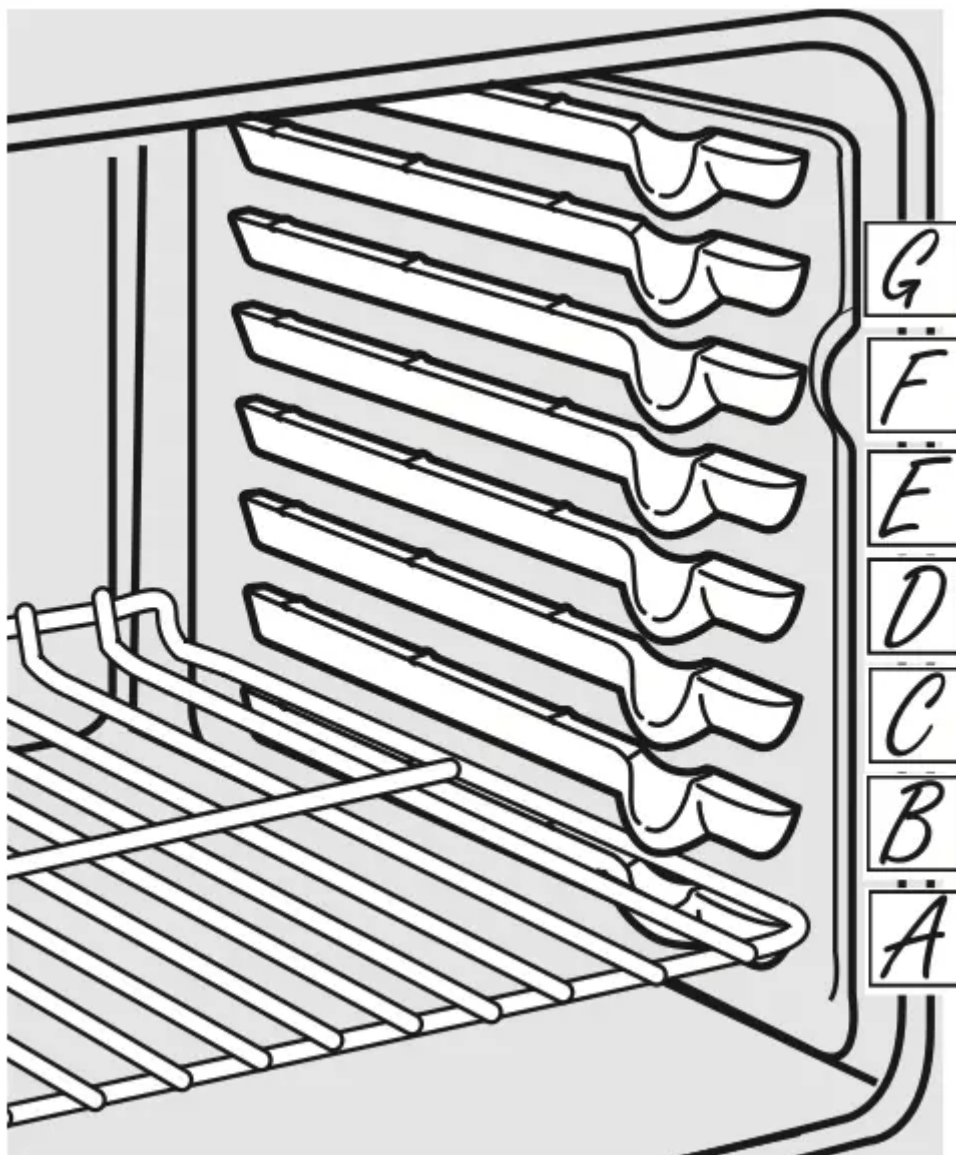

## Broiling Guide

Food	Quantity and/ or Thickness	Rack Position	First Side Time (min.)	Second Side Time (min.)	Comments
<b>Ground Beef</b>	1/2" to 3/4" thick	D	13	8	Space evenly.
<b>Beef Steaks</b>					
Rare†	3/4" to 1" thick	F	6	4	Steaks less than 3/4" thick are difficult to cook rare. Slash fat.
Medium	1 to 1 1/2 lbs.	E	8	6	
Well Done		E	10	8	
Rare†	1 1/2" thick	E	15	10	
Medium	2 to 2 1/2 lbs.	E	15	15	
Well Done		D	20	20	
<b>Chicken</b>					
	1 whole cut up 2 to 2 1/2 lbs., split lengthwise Breast	C	25	25	Brush each side with melted butter. Broil skin-side-down first.
		C	25	15	
<b>Bakery Product</b>					
Bread (toast)	2 to 4 slices	F	3	1	Space evenly. Place English muffins cut-side-up and brush with butter if desired.
English Muffin	2 (split)	F	3-4		
<b>Lobster Tails</b>	2-4	C	18-20	Do not turn over.	Cut through back of shell. Spread open. Brush with melted butter before broiling and after half of broiling time.
<b>Fish Fillets</b>	1 lb. (1/4" to 1/2" thick)	E	6	6	Handle and turn very carefully. Brush with lemon butter before and during cooking, <b>if desired.</b>
<b>Salmon</b>					
Steaks	2 (1" thick)	E	10	5	Turn carefully. Do not turn skin-side-down.
Fillets	2 (1/2" to 3/4" thick)	E	15		
<b>Ham Slices</b> (precooked)	1/2" thick 1" thick	D D	8 8	5 8	
<b>Pork Chops</b>					
Well Done	2 (1/2" thick) 2 (1" thick) about 1 lb.	D D	10 15	10 5	Slash fat.

## Using the clock and timer

Not all features are on all models.

### To Set the Clock

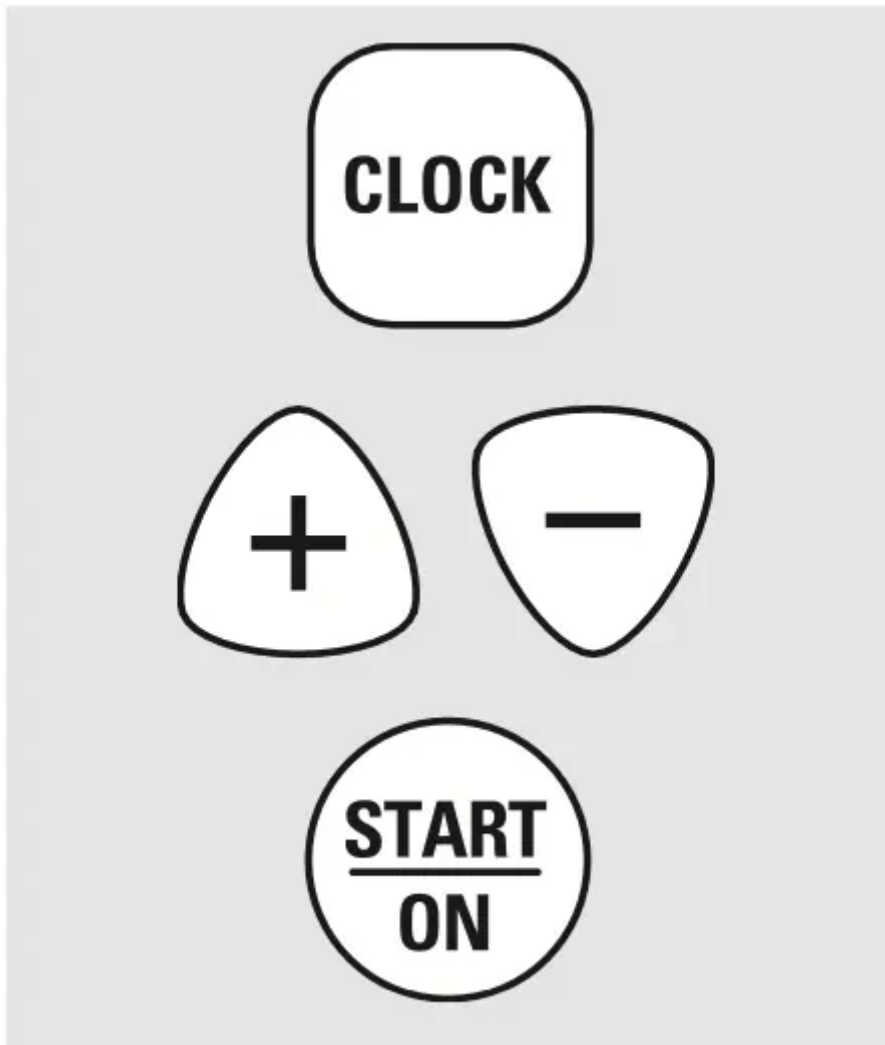

To Set the Clock The clock must be set to the correct time of day for the automatic oven timing functions to work properly. The time of day cannot be changed during a delayed cooking or a delayed self-cleaning cycle.

1. Touch the CLOCK pad twice.

2. Touch the + or – pads.

If the + or – pads are not touched within one minute after you touch the CLOCK pad, the display reverts to the original setting. If this happens, touch the CLOCK pad twice and reenter the time of day.

3. Touch the START/ON pad until the time of day shows in the display. This enters the time and starts the clock.

To check the time of day when the display is showing other information, simply touch the CLOCK pad. The time of day shows until another pad is touched.

### **To Turn Off the Clock Display**

If you have several clocks in your kitchen, you may wish to turn off the time of day clock display on your range.

1. Touch the CLOCK pad once to turn off the time of day display. Although you will not be able to see it, the clock maintains the correct time of day.
2. Touch the CLOCK pad twice to recall the clock display.

### To Set the Timer

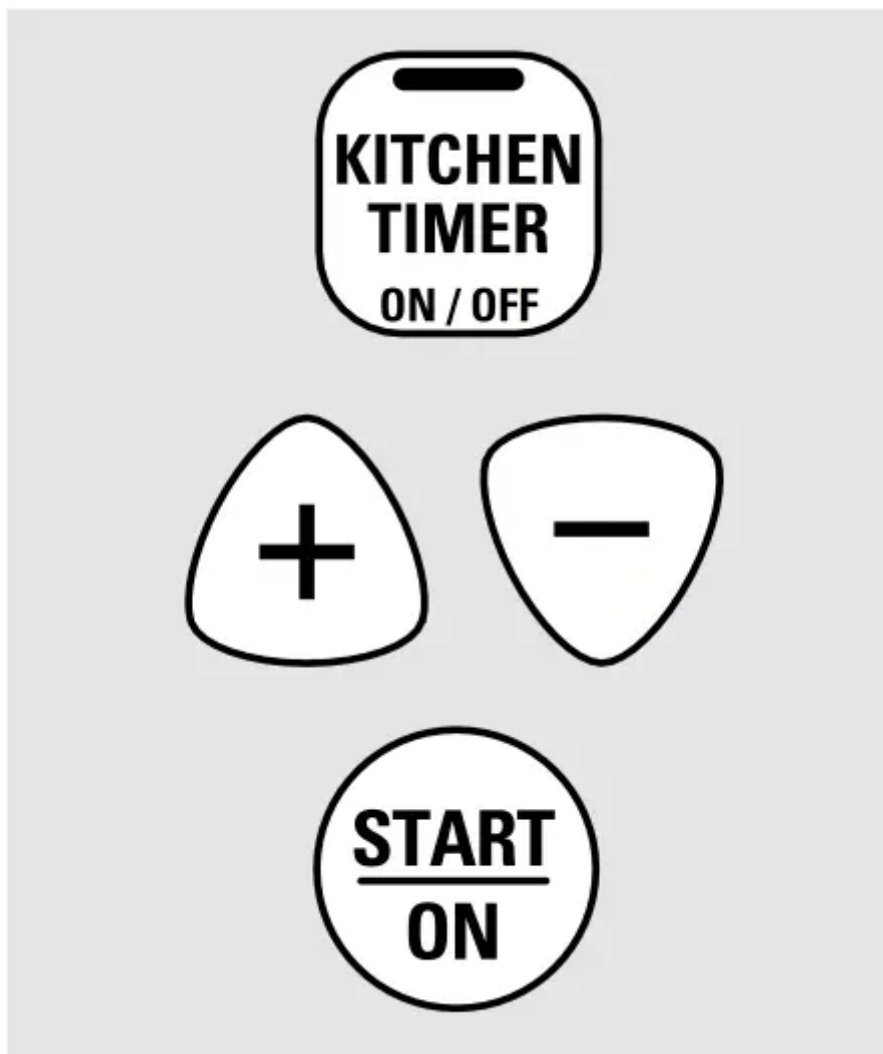

The timer does not control oven operations. The maximum setting on the timer is 9 hours and 59 minutes.

1. Touch the KITCHEN TIMER ON/OFF pad.
2. Touch the + or – pads until the amount of time you want shows in the display. The maximum time that can be entered in minutes is 59. Times more than 59 minutes should be changed to hours and minutes.  
If you make a mistake, touch the KITCHEN TIMER ON/OFF pad and begin again.
3. Touch the START/ON pad. The time will start counting down, although the display does not change until one minute has passed.

4. When the timer reaches :00, the control will beep 3 times followed by one beep every 6 seconds until the KITCHEN TIMER ON/OFF pad is touched. The CLEAR/OFF pad does not need to be touched.

### **To Reset the Timer**

If the display is still showing the time remaining, you may change it by touching the KITCHEN TIMER ON/OFF pad, then touching the + or – pads until the time you want appears in the display.

If the remaining time is not in the display (clock, start time set time or cooking time are in the display), recall the remaining time by touching the KITCHEN TIMER ON/OFF pad and then touching the + or – pads to enter the new time you want.

### **To Cancel the Timer**

Touch the KITCHEN TIMER ON/OFF pad twice.

### **Using the timed baking and roasting features (on some models).**

Do not lock the oven door with the latch during timed cooking. The latch is used for self-cleaning only.

**NOTE:** Foods that spoil easily—such as milk, eggs, fish, stuffings, poultry and pork—should not be allowed to sit for more than 1 hour before or after cooking. Room temperature promotes the growth of harmful bacteria. Be sure that the oven light is off because heat from the bulb will speed harmful bacteria growth.

### **How to Set an Immediate Start and Automatic Stop**



The oven will turn on immediately and cook for a selected length of time. At the end of the cooking time, the oven will turn off automatically.

1. Touch the BAKE pad.
2. Touch the + or – pads to set the oven temperature.
3. Touch the COOKING TIME pad.

**NOTE:** If your recipe requires preheating, you may need to add additional time to the length of the cooking time.

4. Touch the + or – pads to set the baking time.

The cooking time that you entered will be displayed. (If you select Cooking Time first and then adjust the Bake Temperature, the oven temperature will be displayed instead).

5. Touch the START/ON pad.

The display shows either the oven temperature that you set or the cooking time countdown. (The display starts with “PrE” if showing the oven temperature.)

The oven will continue to cook for the programmed amount of time, then turn off automatically.

6. Touch the CLEAR/OFF pad to clear the display if necessary.

Remove the food from the oven. Remember, even though the oven shuts off automatically, foods continue cooking after controls are off.

### **How to Set a Delayed Start and Automatic Stop**



The oven will turn on at the time of day you set, cook for a specific length of time and then turn off automatically.

Make sure the clock shows the correct time of day.

1. Touch the BAKE pad.
2. Touch the + or – pads to set the oven temperature.
3. Touch the COOKING TIME pad.
4. Touch the + or – pads to set the desired length of cooking time.
5. Touch the START TIME pad.
6. Touch the + or – pads to set the time of day you want the oven to turn on and start cooking.
7. Touch the START/ON pad.

**NOTE:** An attention tone will sound if you are using timed baking and do not touch the START/ON pad.

**NOTE:** If you would like to check the times you have set, touch the START TIME pad to check the start time set time you have set or touch the COOKING TIME pad to check the length of cooking time you have set.

When the oven turns on at the time of day you have set, the display will show “PrE” until it reaches the selected temperature, then it will display the oven temperature.

At the end of cooking time, the oven will turn off and the end-of-cycle tone will sound.

8. Touch the CLEAR/OFF pad to clear the display if necessary.

Remove the food from the oven. Remember, even though the oven shuts off automatically, foods continue cooking after controls are off.

## **Special features of your oven control.**

Your new touch pad control has additional features that you may choose to use. The following are the features and how you may activate them.

The special feature modes can only be activated while the display is showing the time of day. They remain in the control's memory until the steps are repeated.

When the display shows your choice, touch the START/ON pad. The special features will remain in memory after a power failure.

**NOTE:** The Sabbath feature and the Thermostat Adjustment feature are also Special Features, but they are addressed separately in the following sections.

### **12 Hour Shut-Off**

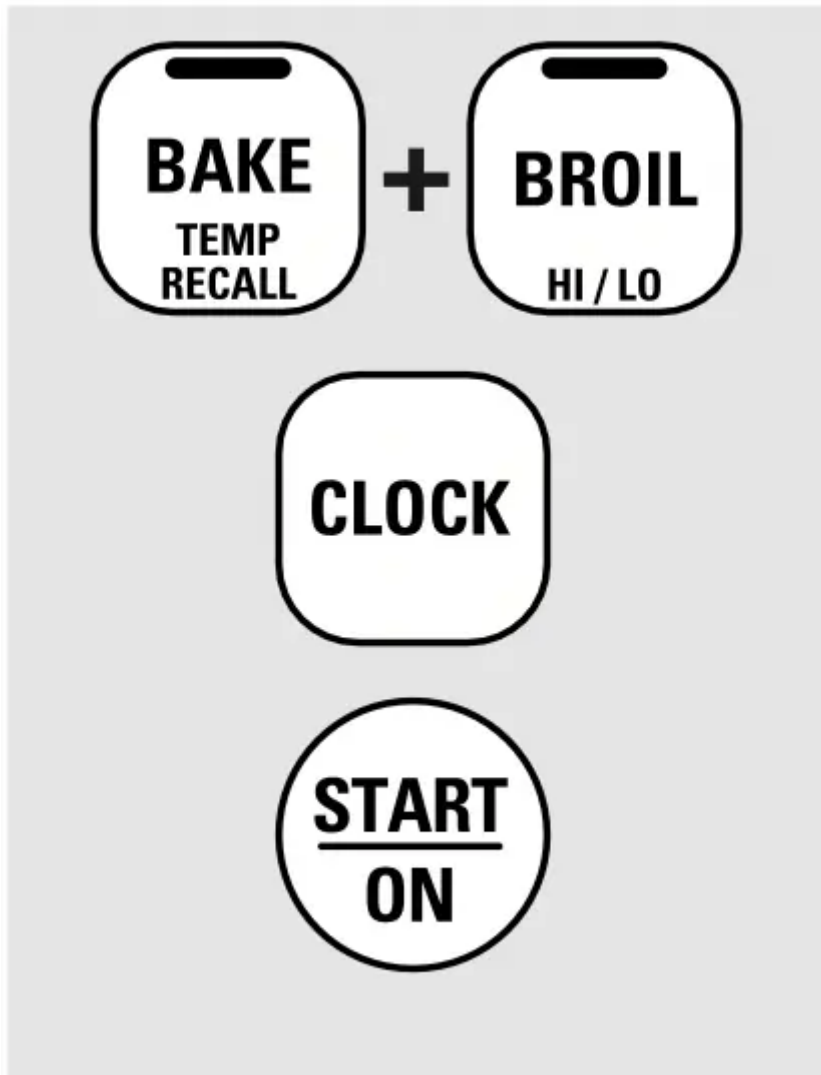

With this feature, should you forget and leave the oven on, the control will automatically turn off the oven after 12 hours during baking functions or after 3 hours during a broil function.

If you wish to turn OFF this feature, follow the steps below.

1. Touch the BAKE and BROIL HI/LO pads at the same time for 3 seconds until the display shows SF.
2. Touch the CLOCK pad. The display will show ON (12 hour shut-off). Touch the CLOCK pad repeatedly until the display shows OFF (no shut-off).
3. Touch the START/ON pad to activate the no shut-off and leave the control set in this special features mode.

### **Using the Sabbath Feature (on some models).**



The Sabbath feature can be used for baking/roasting only. It cannot be used for broiling, self-cleaning or Start Time cooking.

**NOTE:** The oven light comes on automatically (on some models) when the door is opened and goes off when the door is closed. The bulb may be removed. See the Oven Light Replacement

section. On models with a light switch on the control panel, the oven light may be turned on and left on.

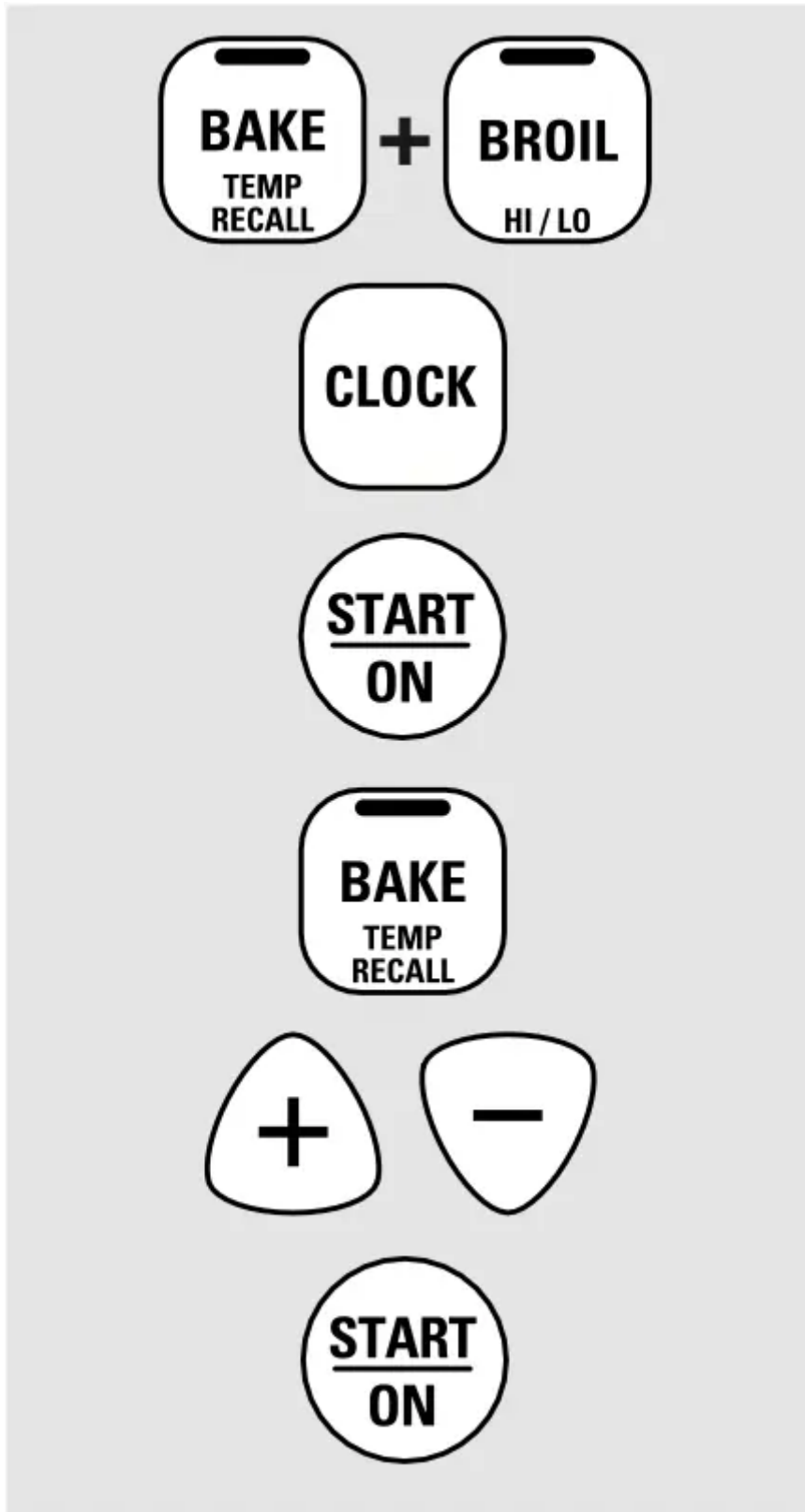
### How to Set for Regular Baking/Roasting





When the display shows  the oven is set in Sabbath. When the display shows  the oven is baking/roasting.



**NOTE:** To understand how the oven control works, practice using regular baking (nonSabbath) before entering Sabbath mode.

Make sure the clock shows the correct time of day and the oven is off.

1. Touch and hold both the BAKE and BROIL HI/LO pads, at the same time, until the display shows SF.
2. Tap the CLOCK pad until SAb appears in the display.
3. Touch the START/ON pad and  will appear in the display.
4. Touch the BAKE pad. No signal will be given.
5. The preset starting temperature will automatically be set to 350.° Tap the + or – pads to increase or decrease the temperature in 5° increments. The temperature can be set between 170° and 550.° No signal or temperature will be given.
6. Touch the START/ON pad.
7. After a random delay period of approximately 30 seconds to 1 minute,  will appear in the display indicating that the oven is baking/roasting. If  doesn't appear in the display, start again at Step 4.



To adjust the oven temperature, touch the BAKE pad and tap the + or – pads to increase or decrease the temperature in 5° increments. Touch the START/ON pad.

**NOTE:** The CLEAR/OFF and COOKING TIME pads are active during the Sabbath feature.

To exit Sabbath feature see next page.

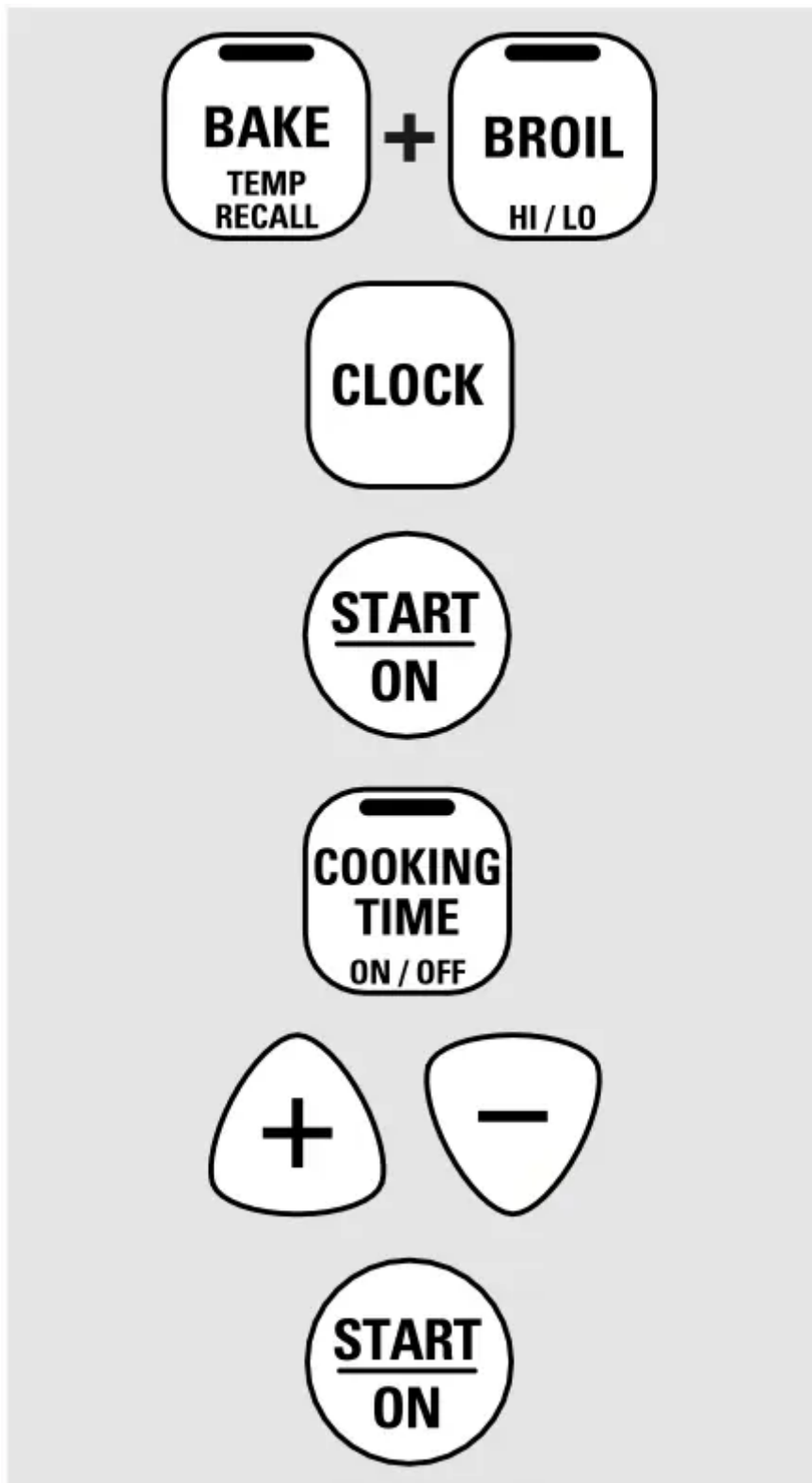

### **How to Set for Timed Baking/Roasting—Immediate Start and Automatic Stop**





When the display shows  the oven is set in Sabbath. When the display shows  the oven is baking/roasting.

**NOTE:** To understand how the oven control works, practice using regular (non-Sabbath) Immediate Start and Automatic Stop before entering the Sabbath mode.

Make sure the clock shows the correct time of day and the oven is off.

1. Touch and hold both the BAKE and BROIL HI/LO pads, at the same time, until the display shows SF.
2. Tap the CLOCK pad until SAb appears in the display.
3. Touch the START/ON pad and  will appear in the display.
4. Touch the COOKING TIME pad.
5. Touch the + or – pads to set the desired length of cooking time between 1 minute and 9 hours and 59 minutes. The cooking time that you entered will be displayed.
6. Touch the START/ON pad.
7. Touch the BAKE pad. No signal will be given.
8. The preset starting temperature will automatically be set to 350.° Tap the + or – pads to increase or decrease the temperature in 5° increments. The temperature can be set between 170° and 550.° No signal or temperature will be given.
9. Touch the START/ON pad.
10. After a random delay period of approximately 30 seconds to 1 minute,  will appear in the display indicating that the oven is baking/roasting. If  doesn't appear in the display, start again at Step 7.

To adjust the oven temperature, touch the BAKE pad and tap the + or – pads to increase or decrease the temperature in 5° increments. Touch the START/ON pad.

When cooking is finished, the display will change from  to  indicating that the oven has turned OFF but is still set in Sabbath. Remove the cooked food.

### **How to Exit the Sabbath Feature**

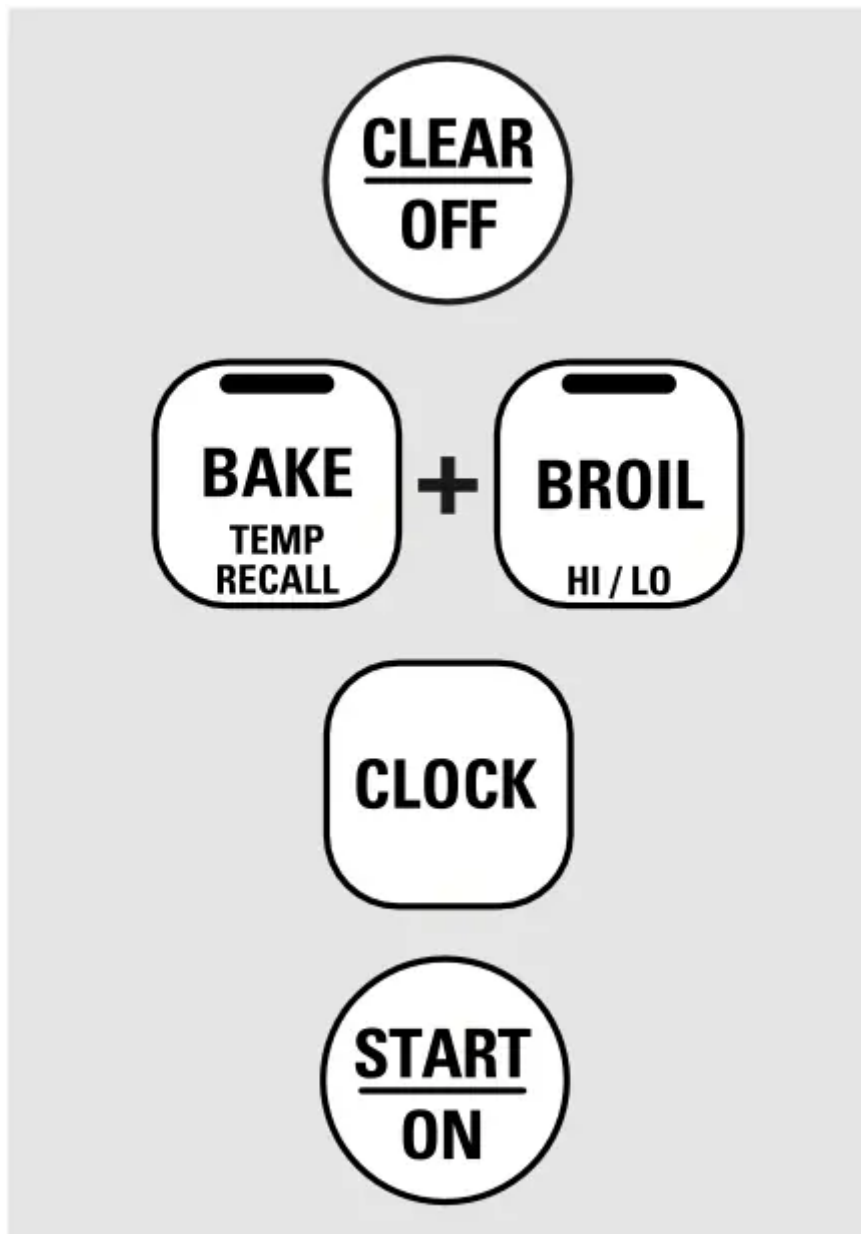

1. Touch the CLEAR/OFF pad.
2. If the oven is cooking, wait for a random delay period of approximately 30 seconds to 1 minute, until only  is in the display.
3. Touch and hold both the BAKE and BROIL HI/LO pads, at the same time, until the display shows SF.
4. Tap the CLOCK pad until ON or OFF appears in the display. ON indicates that the oven will automatically turn off after 12 hours. OFF indicates that the oven will not automatically turn off. See the Special Features section for an explanation of the 12 Hour Shut-Off feature.
5. Touch the START/ON pad.

**NOTE:** If a power outage occurred while the oven was in Sabbath, the oven will automatically turn off and stay off even when the power returns. The oven control must be reset.

## Adjust the oven thermostat—Do it yourself!

You may find that your new oven cooks differently than the one it replaced. Use your new oven for a few weeks to become more familiar with it. If you still think your new oven is too hot or too cold, you can adjust the thermostat yourself.

Do not use thermometers, such as those found in grocery stores, to check the temperature setting of your oven. These thermometers may vary 20–40 degrees.

**NOTE:** This adjustment will not affect the broiling or the self-cleaning temperatures. The adjustment will be retained in memory after a power failure.

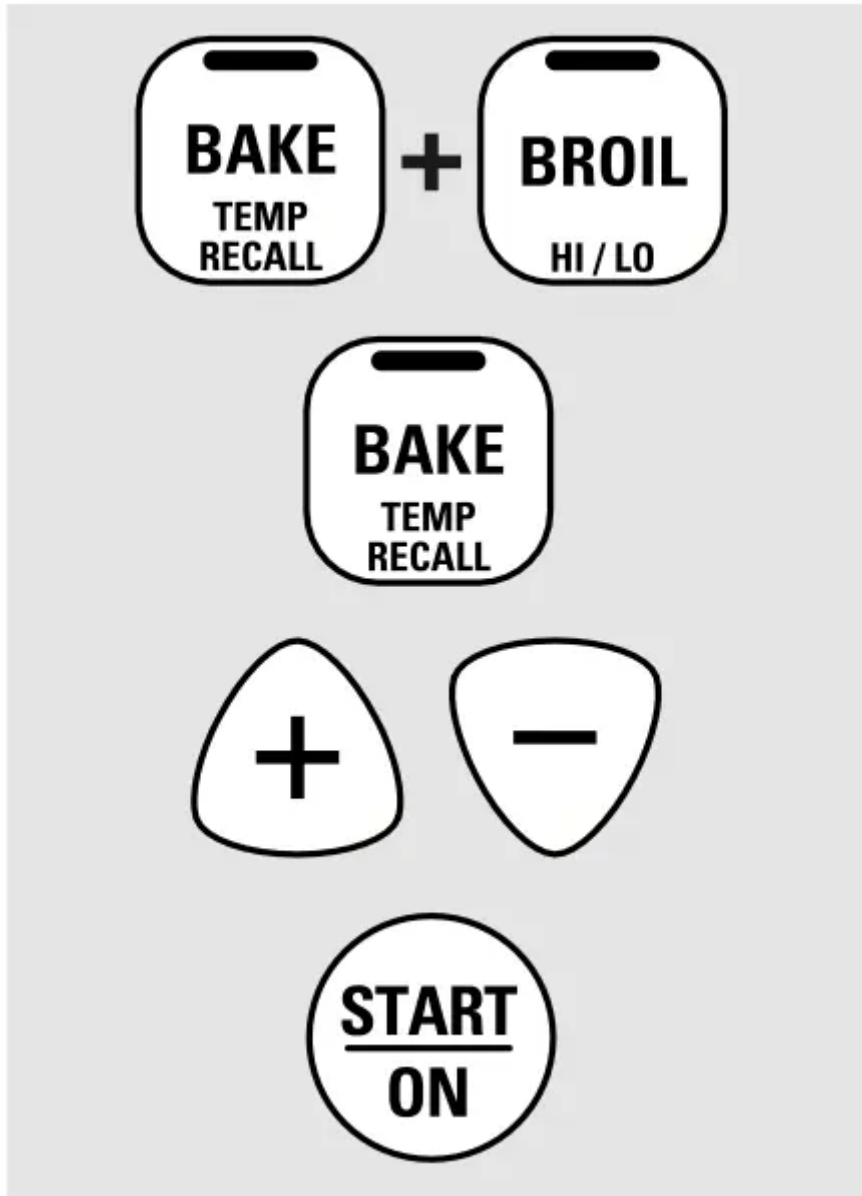

### To Adjust the Thermostat

1. Touch the BAKE and BROIL HI/LO pads at the same time for 2 seconds until the display shows SF.
2. Touch the BAKE pad. A two-digit number shows in the display.

3. The oven temperature can be adjusted up to (+) 35°F hotter or (–) 35°F cooler. Touch the + pad to increase the temperature in 1-degree increments.  
Touch the – pad to decrease the temperature in 1-degree increments.
4. When you have made the adjustment, touch the START/ON pad to go back to the time of day display. Use your oven as you would normally.

**NOTE:** This adjustment will not affect the broiling or self-cleaning temperatures. It will be retained in memory after a power failure.

### **The type of margarine will affect baking performance!**

Most recipes for baking have been developed using high-fat products such as butter or margarine (80% fat). If you decrease the fat, the recipe may not give the same results as with a higher-fat product.

Recipe failure can result if cakes, pies, pastries, cookies or candies are made with low-fat spreads. The lower the fat content of a spread product, the more noticeable these differences become.

Federal standards require products labeled “margarine” to contain at least 80% fat by weight. Low-fat spreads, on the other hand, contain less fat and more water. The high moisture content of these spreads affects the texture and flavor of baked goods. For best results with your old favorite recipes, use margarine, butter or stick spreads containing at least 70% vegetable oil.

### **Using the self-cleaning oven.**

Never force the latch handle. Forcing the handle will damage the door lock mechanism.

### **Before a Clean Cycle**

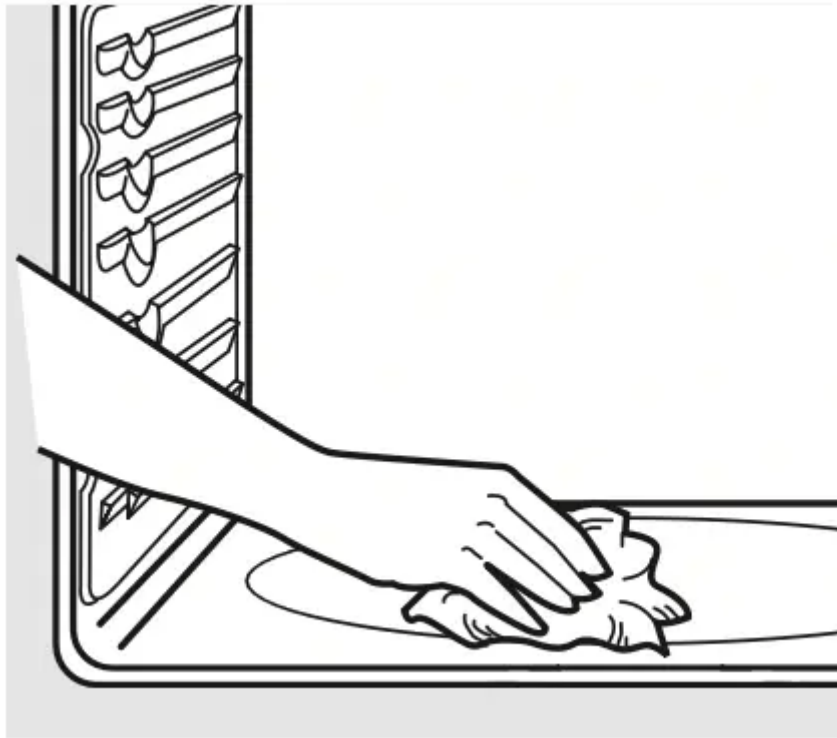

Wipe up heavy soil on the oven bottom.

We recommend venting your kitchen with an open window or using a ventilation fan or hood during the first self-clean cycle.

Remove racks, broiler pan, broiler grid, all cookware and any aluminum foil from the oven.

The shiny, silver-colored oven racks (on some models) can be self-cleaned, but they will darken, lose their luster and become hard to slide.

Soil on the front frame of the range and outside the gasket on the door will need to be cleaned by hand. Clean these areas with hot water, soap-filled steel wool pads or cleansers such as Soft Scrub®. Rinse well with clean water and dry.

Do not clean the gasket. The fiberglass material of the oven door gasket cannot withstand abrasion. It is essential for the gasket to remain intact. If you notice it becoming worn or frayed, replace it.

Wipe up any heavy spillovers on the oven bottom.

Make sure the oven light bulb cover is in place and the oven light is off.

**IMPORTANT:** The health of some birds is extremely sensitive to the fumes given off during the self-cleaning cycle of any range. Move birds to another well-ventilated room.

### **How to Set the Oven for Cleaning**

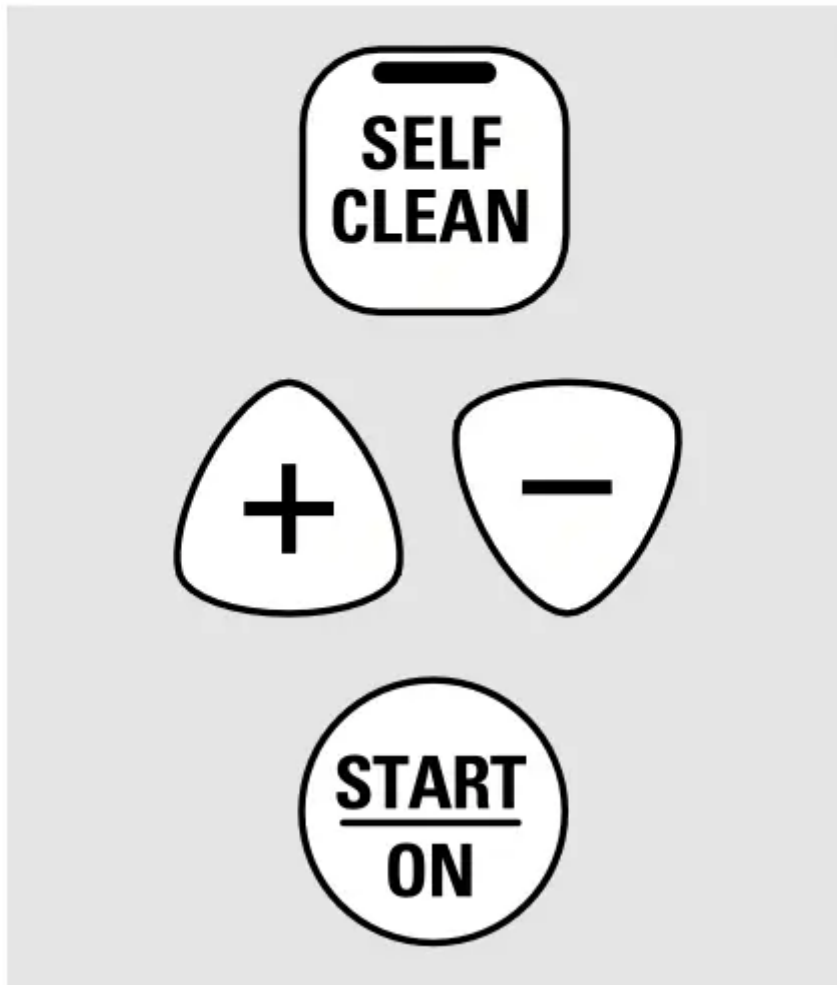
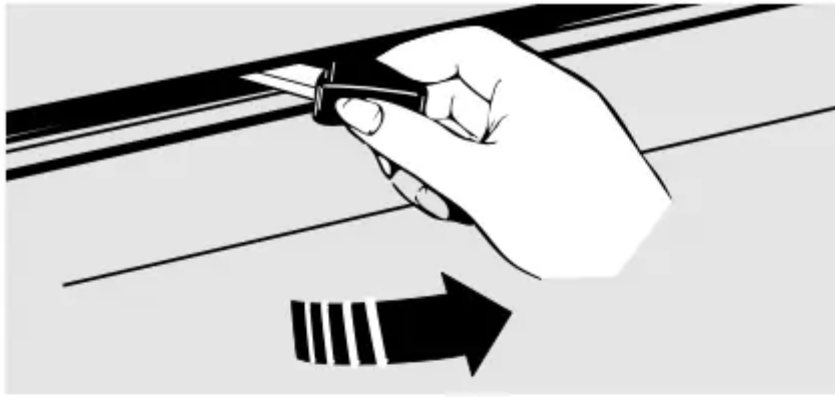

Follow the directions in the Before a Clean Cycle section.

1. Latch the door.
2. Touch the SELF CLEAN pad.
3. Touch the + or – pads until the desired Clean Time is displayed.

The Clean Time is normally 4 hours. You can change the Clean Time to any time between 3 and 5 hours, depending on the amount of soil in your oven.

4. Touch the START/ON pad.

The self-clean cycle will automatically begin after CLEAN is displayed and the time countdown appears in the display.

While the oven is self-cleaning, you can touch the CLOCK pad to display the time of day.

To return to the clean countdown, touch the SELF CLEAN pad.

The oven shuts off automatically when the clean cycle is complete, and 0:00 will flash in the display.

5. Slide the latch handle to the left as far as it will go and open the door.

It will not be possible to unlatch the oven door until the temperature drops below the lock temperature and the clean light goes off.

When the clean light is off, unlatch the door.

### **How to Delay the Start of Cleaning**



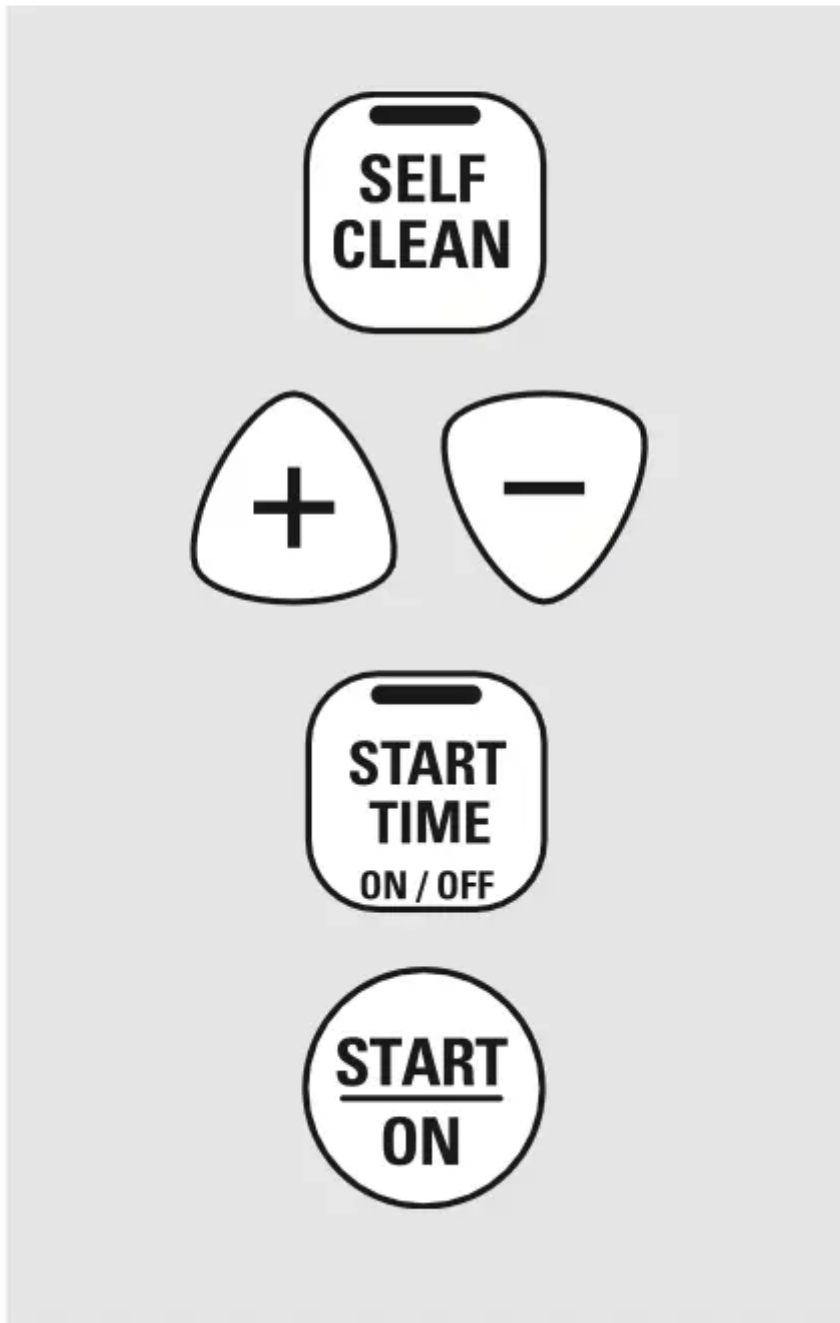
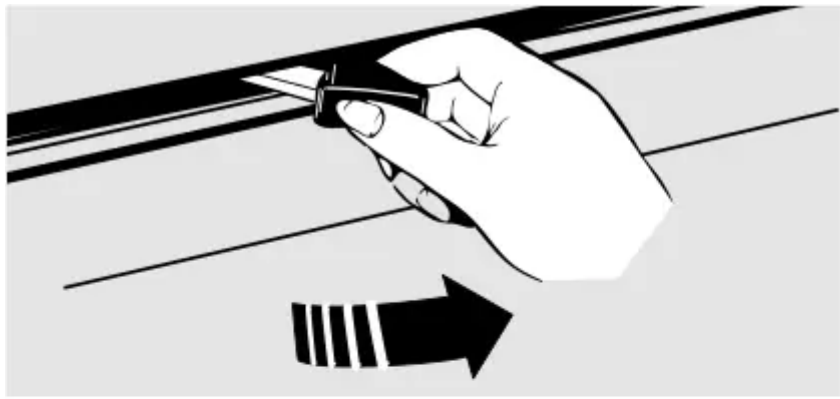

Make sure the clock shows the correct time of day.

1. Latch the door.
2. Touch the SELF CLEAN pad.
3. Using the + or – pads, enter the desired clean time.  
The Clean Time is normally 4 hours. You can change the Clean Time to any time between 3 and 5 hours, depending on the amount of soil in your oven.
4. Touch the START TIME pad. The earliest start time you can set will appear in the display.
5. Using the + or – pads, enter the time of day you want the clean cycle to start.
6. Touch the START/ON pad.

The display will show the start time set time. It will not be possible to unlatch the oven door until the temperature drops below the lock temperature and the clean light goes off.

When the clean light is off, unlatch the door.

### **To Stop a Clean Cycle**

Touch the CLEAR/OFF pad.

Wait until the oven has cooled below the locking temperature to unlatch the door. You will not be able to open the door right away unless the oven has cooled below the locking temperature.

### **After a Clean Cycle**

You may notice some white ash in the oven. Wipe it up with a damp cloth after the oven cools.

If white spots remain, remove them with a soap-filled scouring pad and rinse thoroughly with a vinegar and water mixture.

These deposits are usually a salt residue that cannot be removed by the clean cycle.

If the oven is not clean after one clean cycle, repeat the cycle.

- You cannot set the oven for cooking until the oven is cool enough for the door to be unlatched.
- While the oven is self-cleaning, you can touch the CLOCK pad to display the time of day. To return to the clean countdown, touch the COOKING TIME pad.
- Apply a small amount of vegetable oil to a paper towel and wipe the edges of the oven racks with the paper towel. Do not spray with Pam® or other lubricant sprays.

## **Care and cleaning of the range**

Be sure all controls are off and all surfaces are cool before cleaning any part of the range.

**WARNING:** If your range is removed for cleaning, servicing or any reason, be sure the anti-tip device is reengaged properly when the range is replaced. Failure to take this precaution could result in tipping of the range and cause injury.



## How to Remove Protective Shipping Film and Packaging Tape

Carefully grasp a corner of the protective shipping film with your fingers and slowly peel it from the appliance surface. Do not use any sharp items to remove the film. Remove all of the film before using the appliance for the first time.

To assure no damage is done to the finish of the product, the safest way to remove the adhesive from packaging tape on new appliances is an application of a household liquid dishwashing detergent. Apply with a soft cloth and allow to soak.

**NOTE:** The adhesive must be removed from all parts. It cannot be removed if it is baked on.

## Control Knobs

The control knobs may be removed for easier cleaning.

Make sure the knobs are in the OFF positions and pull them straight off the stems for cleaning.

The knobs can be cleaned in a dishwasher or they may also be washed with soap and water. Make sure the insides of the knobs are dry before replacing.

Replace the knobs in the OFF position to ensure proper placement.

## Burner Assembly

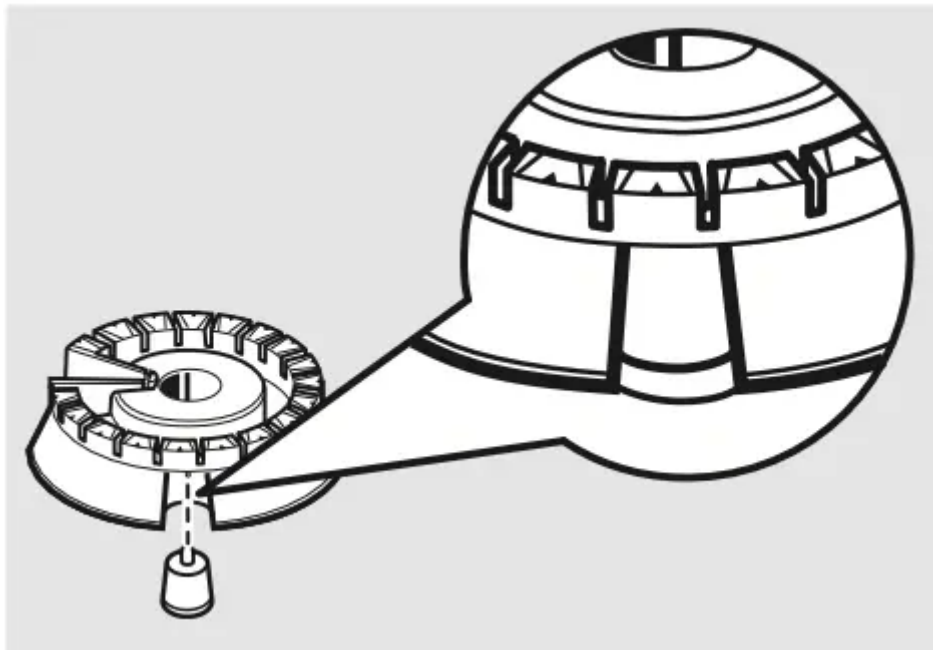

Make sure the slot in the burner head is positioned over electrode.

### **CAUTION: DO NOT OPERATE THE BURNER**

The burner assemblies should be washed regularly and, of course, after spillovers.

Turn all controls off before removing burner parts.

The burner grates, burner heads and burner caps can be removed for easy cleaning.

The electrode of the spark igniter is exposed beyond the surface of the burner base. When cleaning the cooktop, be careful not to snag the electrode of the spark igniter with your cleaning cloth. Damage to the igniter could occur. To avoid snagging a cloth on the spark igniter, leave the burner heads in place when cleaning the cooktop.

Be careful not to push in any cooktop controls while cleaning the cooktop. A slight electrical shock might result which could cause you to knock over hot cookware.

Wash burner parts with an all-purpose non-abrasive cleaner and warm water. Soak stubborn soil. Dry them with a cloth—do not reassemble while wet.

**To reassemble the surface burners:**

1. Place burner heads over the electrodes on the cooktop, in the correct locations according to their size.

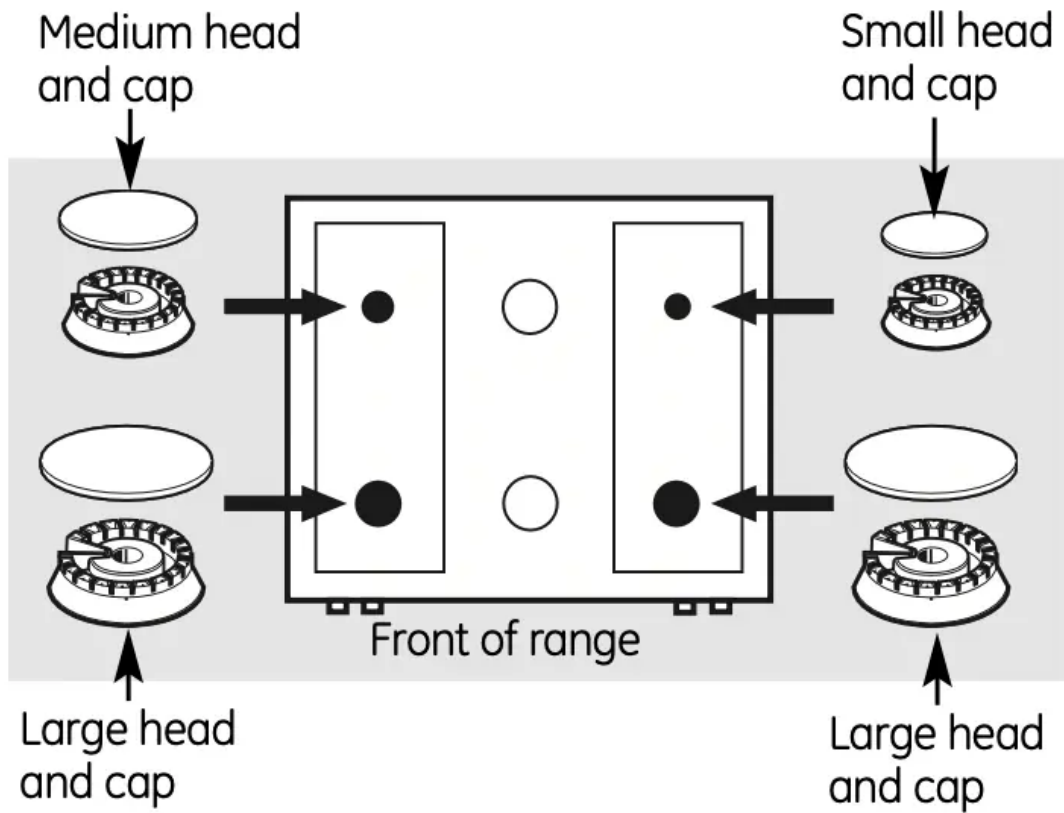

2. Place the matching size caps onto the heads. Make sure that the heads and caps are placed in the correct locations.

After cleaning, first replace the vent grille and vent grille cap. Replace the side grates so that they fit over the tabs on the vent grille. Make sure the grates are positioned securely

over the burners and that they are stable and level.

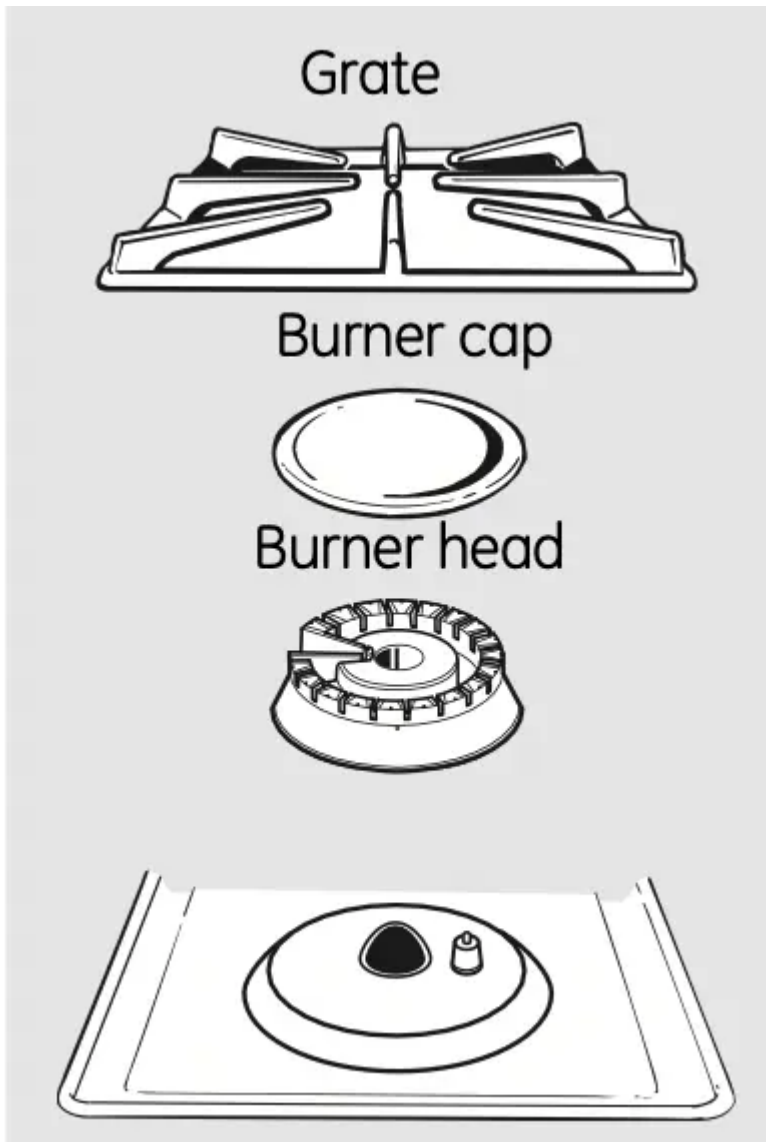

### Burner Grates, Vent Grille and Vent Grille Cap

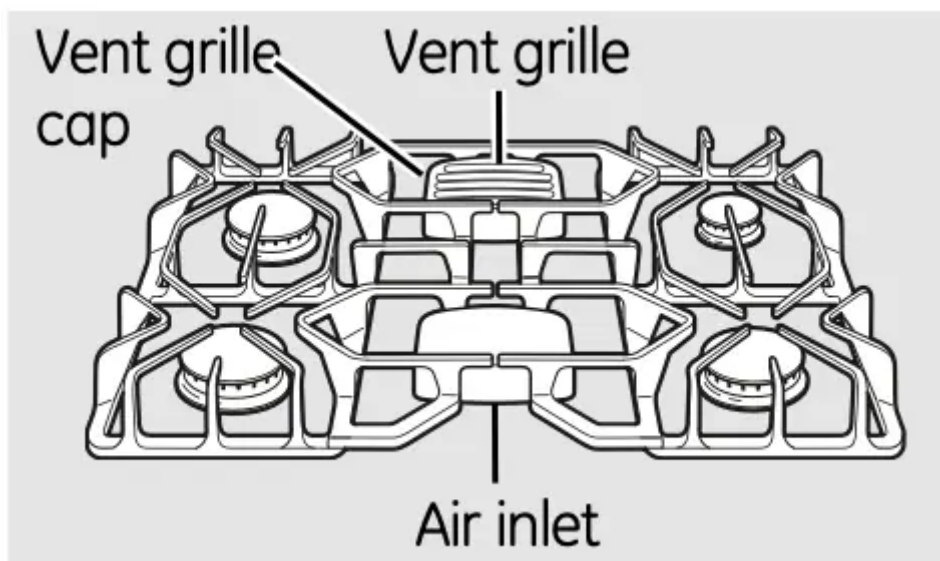

Porcelain enamel burner grates, vent grille and vent grille cap should be washed regularly and, of course, after spillovers.

Wash them in hot, soapy water and rinse with clean water. You may also use abrasive cleaners and scouring pads, if needed. Dry them with a cloth—don't put them back on the cooktop wet.

Although they're durable, the grates, vent grille and vent grille cap will gradually lose their shine, regardless of the best care you can give them. This is due to their continual exposure to high temperatures.

Do not operate a burner for an extended period of time without cookware on the grate. The finish on the grate may chip without cookware to absorb the heat.

After cleaning, first replace the vent grille and the vent grille cap.

Replace the side grates so that they fit over the tabs on the vent grille. Make sure the grates are positioned securely over the burners and that they are stable and level.

### **Rubber Grate Feet**

For stability, your cooktop has rubber feet on the burner grates. If any of these rubber feet should become damaged or lost, replace them immediately.

## Oven Light Bulbs (if included)

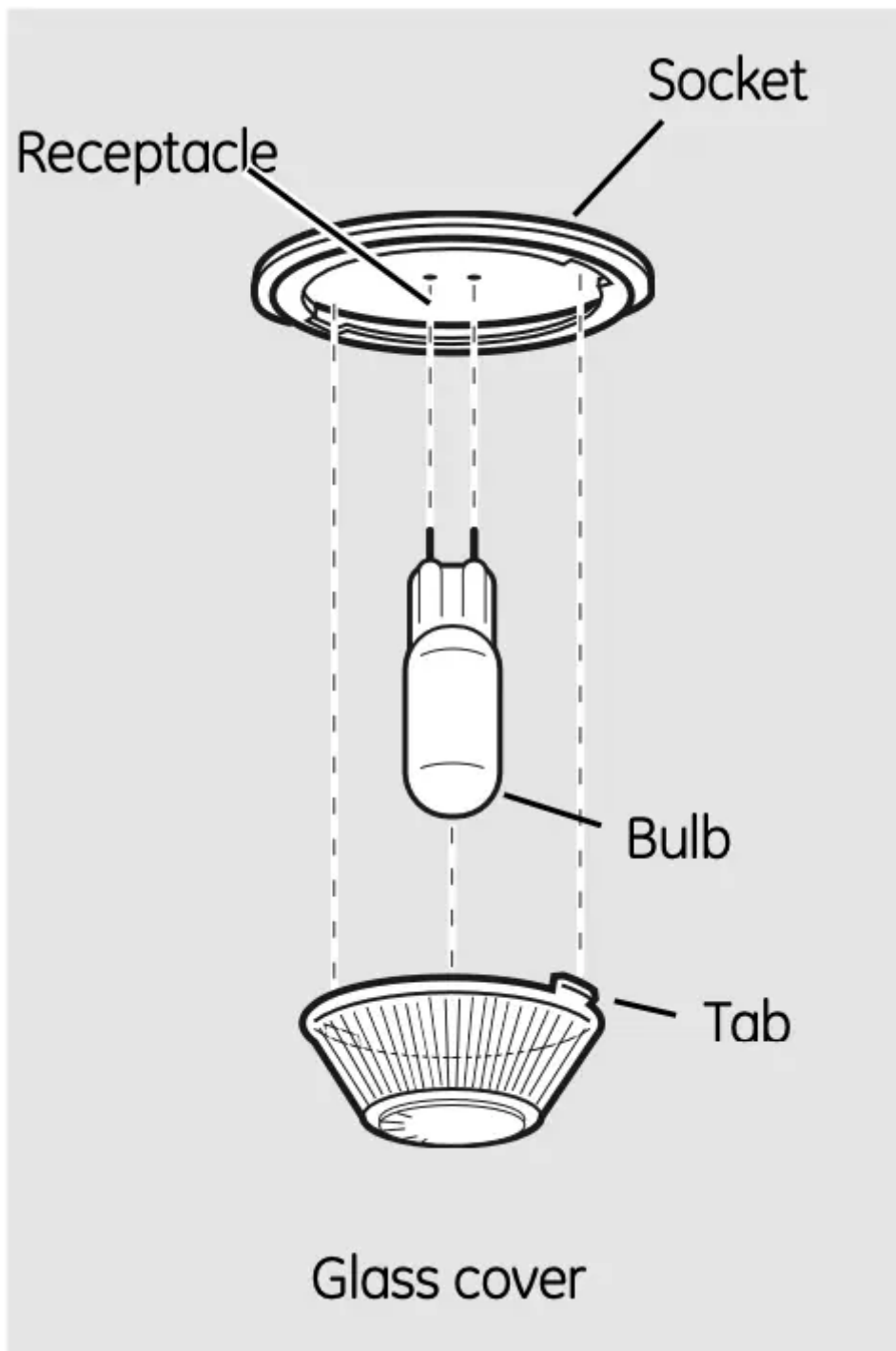

**NOTE:** The glass cover should be removed only when cold. Wearing latex gloves may offer a better grip.

**CAUTION:** Before replacing your oven light bulb, disconnect the electrical power to the oven at the main fuse or circuit breaker panel.

Be sure to let the light cover and bulb cool completely

For your safety, do not touch a hot bulb with bare hands or a damp cloth.

**To remove:**

1. Turn the glass cover counterclockwise 1/4 turn until the tabs of the glass cover clear the grooves of the socket.
2. Using gloves or a dry cloth, remove the bulb by pulling it straight out.

**To replace:**

1. Use a new 130-volt halogen bulb, not to exceed 50 watts.
2. Using gloves or a dry cloth, remove the bulb from its packaging. Do not touch the bulb with bare fingers.

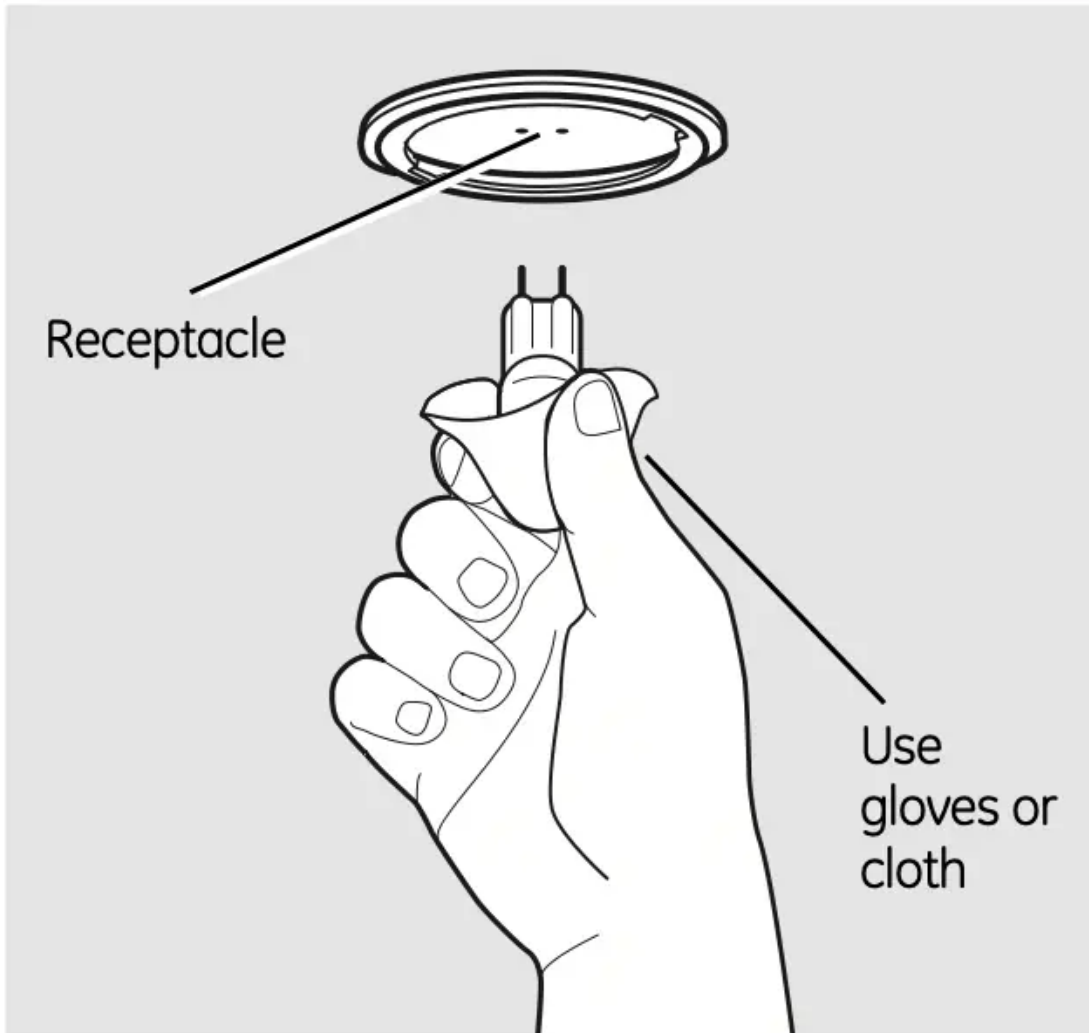

3. Push the bulb straight into the receptacle all the way.
4. Place the tabs of the glass cover into the grooves of the socket. Turn the glass cover clockwise 1/4 turn to engage.  
For improved lighting inside the oven, clean the glass cover frequently using a wet cloth. This should be done when the oven is completely cool.
5. Reconnect electrical power to the oven.

## Oven Light Replacement (if included)

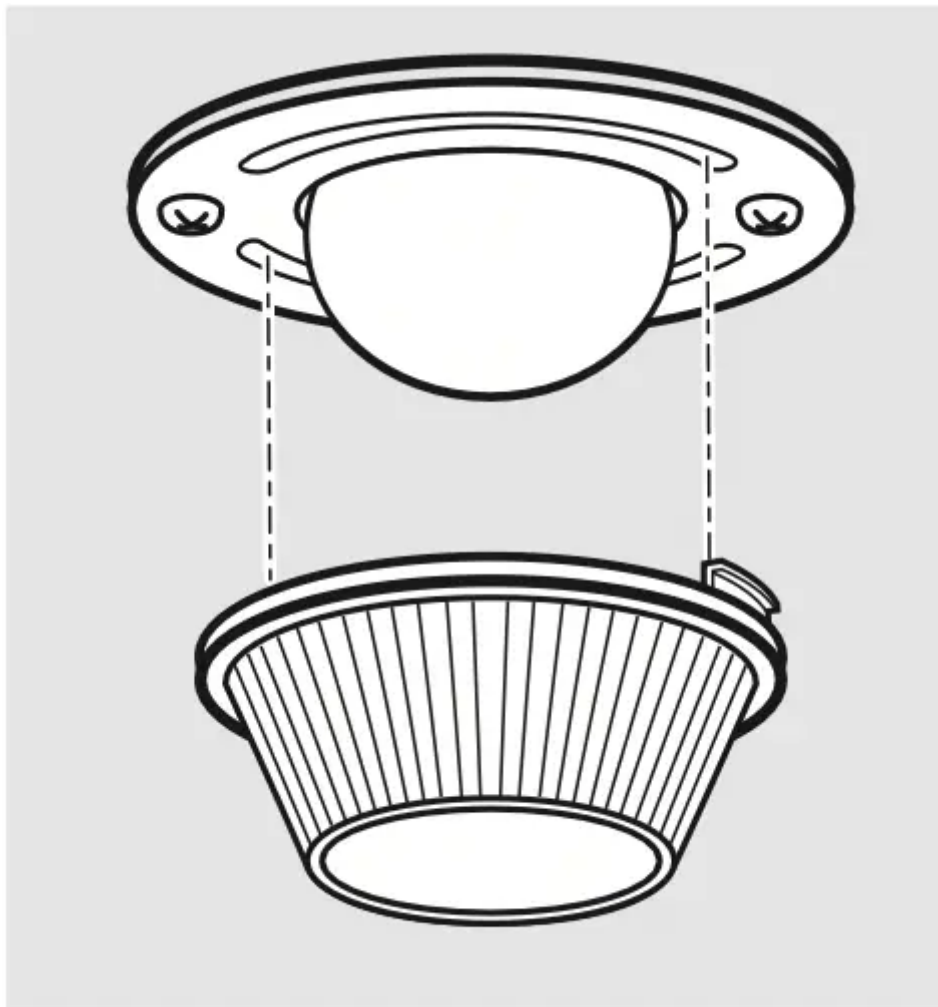

**CAUTION:** Before replacing your oven light bulb, disconnect the electrical power to the range at the main fuse or circuit breaker panel.

Be sure to let the light cover and bulb cool completely.

### To remove the cover:

1. Twist lens counterclockwise about a quarter turn to remove.  
Do not remove any screws to remove the cover.
2. Replace bulb with a 40-watt appliance bulb or two-prong halogen bulb as appropriate.

### To replace the cover:

1. Line up tabs of lens in front of tabs on housing and rotate clockwise to engage.
2. Connect electrical power to the range.

## Storage Drawer Removal

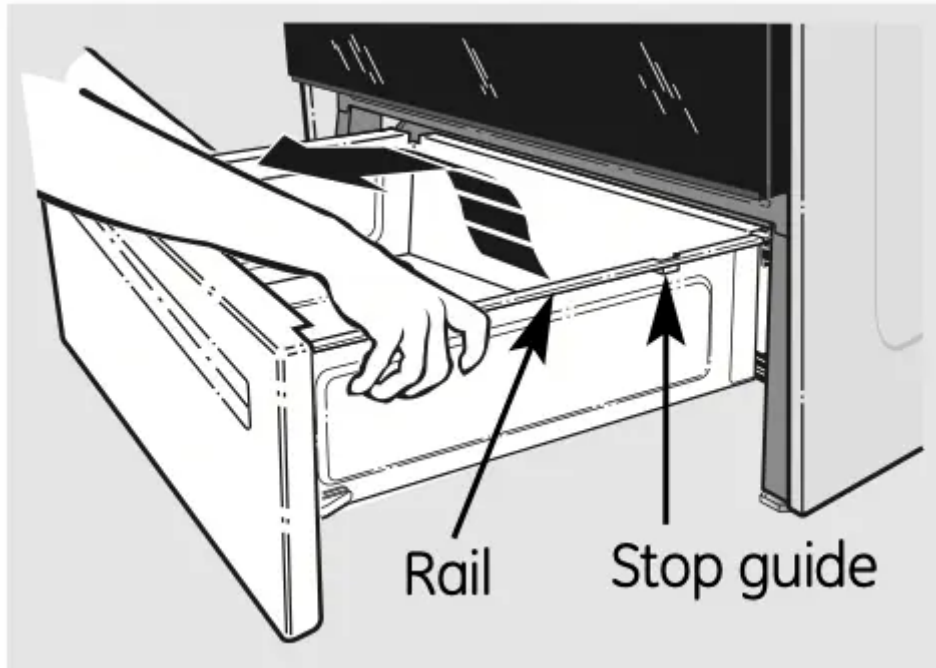

### To remove the drawer:

1. Pull the drawer out until it stops.
2. Lift the front of the drawer until the stops clear the guides.
3. Remove the drawer.

### To replace the drawer:

1. Place the drawer rails on the guides.
2. Push the drawer back until it stops.
3. Lift the front of the drawer and push back until the stops clear the guides.
4. Lower the front of the drawer and push back until it closes.

## Oven Racks

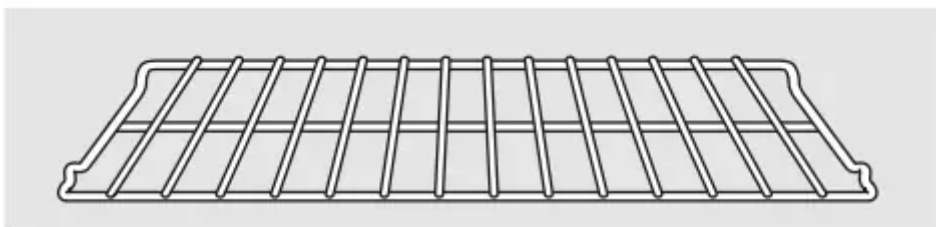

Oven rack

All oven racks may be cleaned by hand with an abrasive cleaner or steel wool. After cleaning, rinse the racks with clean water and dry with a clean cloth. Gray porcelain-coated oven racks may remain in the oven during the self-cleaning cycle without being damaged. The shiny, silver-colored

oven racks may remain in the oven during the self-cleaning cycle, but they will lose their luster and become hard to slide.

It will be necessary to grease all oven rack side edges with a light coating of vegetable oil after cleaning them by hand or in the oven. This will help maintain the ease of sliding the racks in and out of the oven.

## Cleaning the Oven Door

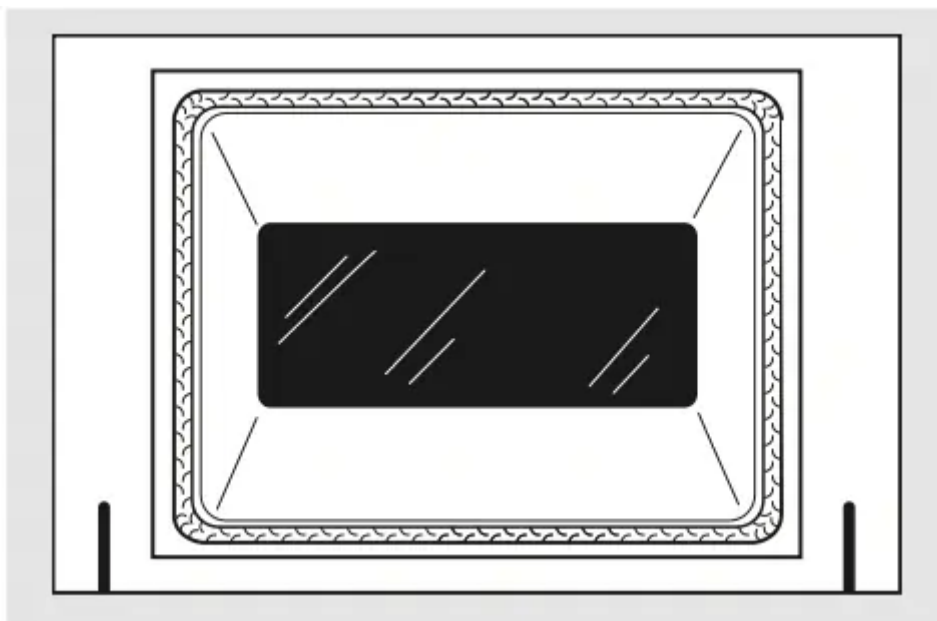

Do not rub or clean the door gasket— it has an extremely low resistance to abrasion. If you notice the gasket becoming worn, frayed or damaged in any way or if it has become displaced on the door, you should have it replaced.

### To clean the inside of the door:

- Because the area inside the gasket is cleaned during the self-clean cycle, you do not need to clean this by hand.
- The area outside the gasket and the door liner can be cleaned with a soap-filled or plastic scouring pad, hot water and detergent. Rinse well with a vinegar and water solution.

### To clean the outside of the door:

- Use soap and water to thoroughly clean the top, sides and front of the oven door. Rinse well. You may also use a glass cleaner to clean the glass on the outside of the door. Do not let water drip into the vent openings.
- If any stain on the door vent trim is persistent, use a soft abrasive cleaner and a sponge-scrubber for best results.

- Spillage of marinades, fruit juices, tomato sauces and basting materials containing acids may cause discoloration and should be wiped up immediately. When surface is cool, clean and rinse.
- Do not use oven cleaners, cleaning powders or harsh abrasives on the outside of the door.

## Lift-Off Oven Door

The door is very heavy. Be careful when removing and lifting the door.  
Do not lift the door by the handle.

### To remove the door:

1. Fully open the door.
2. Pull the hinge locks down toward the door frame, to the unlocked position. A tool, such as a small flat-blade screwdriver, may be required.

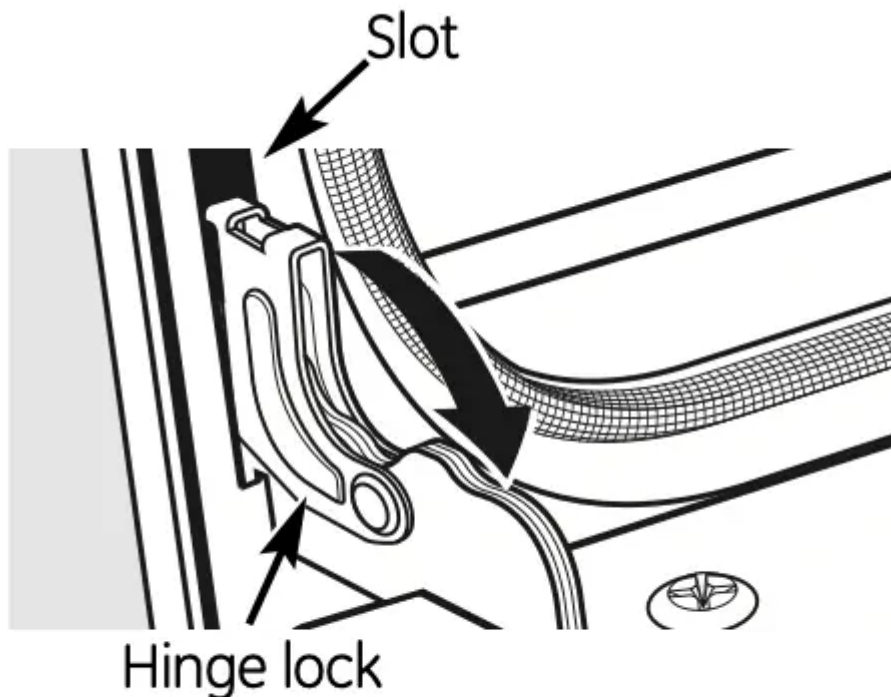

*Pull hinge locks down to unlock.*

3. Firmly grasp both sides of the door at the top.
4. Close door to the door removal position, which is halfway between the broil stop position and fully closed.

5. Lift door up and out until the hinge arm is clear of the slot.



*Removal position*

**To replace the door:**

1. Firmly grasp both sides of the door at the top.
2. With the door at the same angle as the removal position, seat the indentation of the hinge arm into the bottom edge of the hinge slot. The notch in the hinge arm must be fully seated into the bottom of the slot.

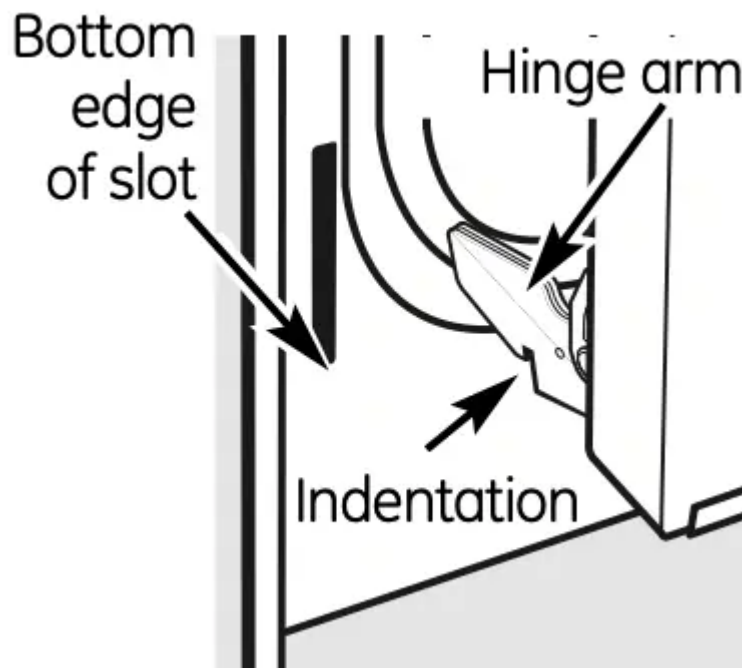

3. Fully open the door. If the door will not fully open, the indentation is not seated correctly in the bottom edge of the slot.

4. Push the hinge locks up against the front frame of the oven cavity to the locked position.

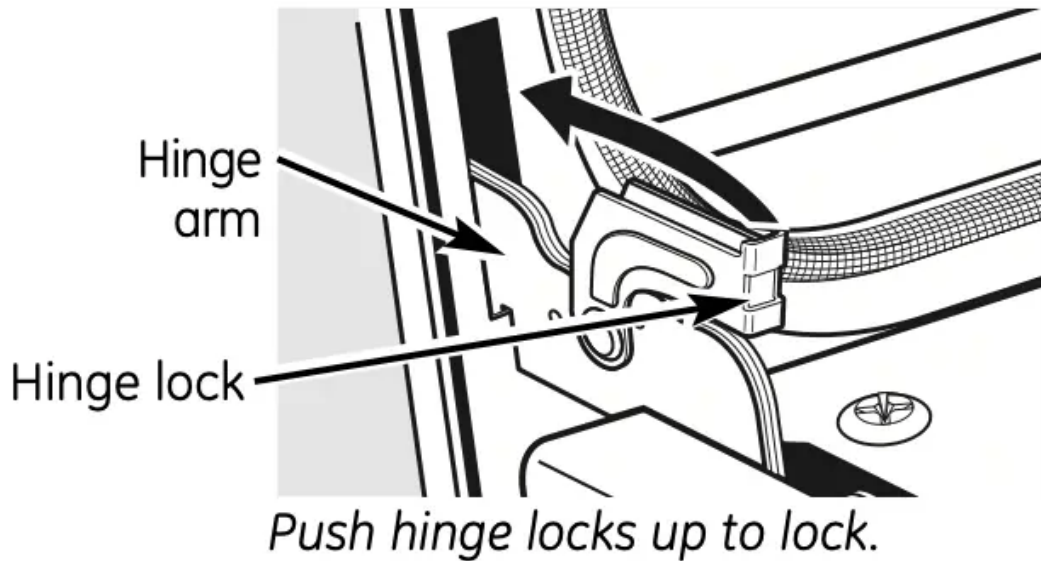

5. Close the oven door.

### **Stainless Steel Surfaces (on some models)**

Do not use a steel wool pad; it will scratch the surface.

To clean the stainless steel surface, use warm sudsy water or a stainless steel cleaner or polish. Always wipe the surface in the direction of the grain. Follow the cleaner instructions for cleaning the stainless steel surface.

### **Painted Surfaces**

Painted surfaces include the top and sides of the door, and the drawer front. Clean these with soap and water or a vinegar and water solution.

Do not use commercial oven cleaners, cleaning powders, steel wool or harsh abrasives on any painted surface.

### **Oven Vent and Cooktop Air Inlet**

The oven is vented through an opening in the cooktop under the grille. The cooktop takes in air through the air inlet located through the cooktop.

Never cover these openings with aluminum foil or any other material. This would prevent the vents from working properly.

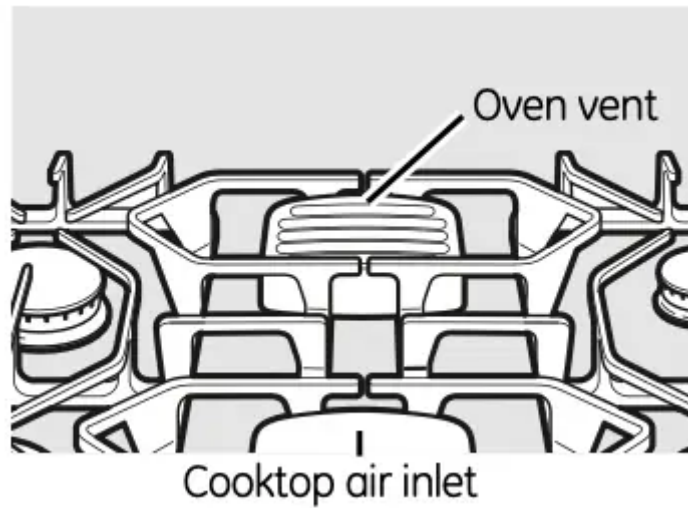

## Control Panel

If desired, the touch pads may be turned off before cleaning.

See the Control Lockout section.

Clean up splatters with a damp cloth.

Remove heavier soil with warm soapy water. Do not use abrasives of any kind.

Turn on the touch pads after cleaning.

## Removable Oven Floor

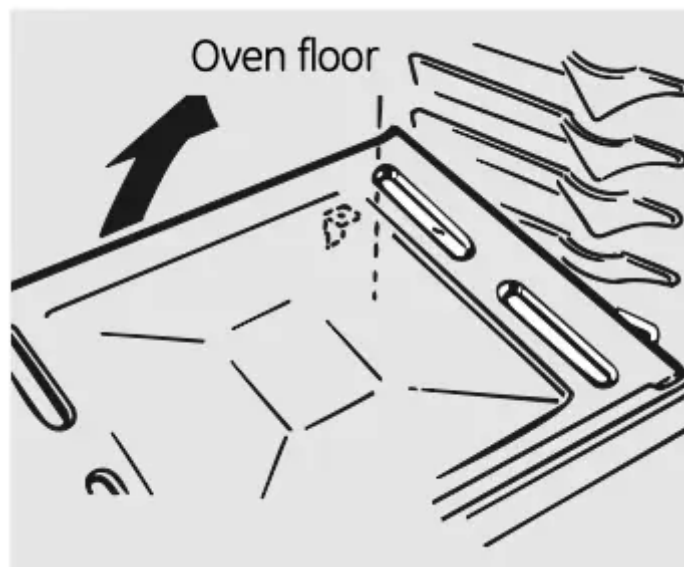

### To remove the oven floor for easier cleaning:

1. Remove the oven door using the instructions in the Lift-Off Oven Door section.
2. Grasp oven floor at the rear finger slots on each side, lift it up, push it back and pull it out.

3. Clean the oven floor with warm soapy water.

**IMPORTANT:** Always replace the removable floor before the next use.

## Troubleshooting Tips

Save time and money! Review the charts on the following pages first and you may not need to call for service.



Problem	Possible Causes	What To Do
<p><b>Burners have yellow or yellow-tipped flames</b></p>	<p>The combustion quality of burner flames needs to be determined visually.</p>	<ul style="list-style-type: none"> <li>Use the illustrations below to determine if your burner flames are normal. If burner flames look like A, call for service. Normal burner flames should look like B or C, depending on the type of gas you use. With LP gas, some yellow tipping on outer cones is normal.</li> </ul> <div style="text-align: center;">  <p><b>A–Yellow flames</b> Call for service</p> <p><b>B–Yellow tips on outer cones</b> Normal for LP gas</p> <p><b>C–Soft blue flames</b> Normal for natural gas</p> </div>
<p><b>Control knobs will not turn</b></p>	<p>Knob isn't pushed down.</p>	<ul style="list-style-type: none"> <li>To turn from the OFF position, push the knob in and then turn.</li> </ul>
<p><b>Burners do not light</b></p>	<p>Plug on range is not completely inserted in the electrical outlet.</p>	<ul style="list-style-type: none"> <li>Make sure electrical plug is plugged into a live, properly grounded outlet.</li> </ul>
	<p>Gas supply not connected or turned on.</p>	<ul style="list-style-type: none"> <li>See the Installation Instructions that came with your range.</li> </ul>
	<p>A fuse in your home may be blown or the circuit breaker tripped.</p>	<ul style="list-style-type: none"> <li>Replace the fuse or reset the circuit breaker.</li> </ul>
	<p>Burner parts not replaced correctly.</p>	<ul style="list-style-type: none"> <li>See the Care and cleaning of the range section.</li> </ul>
<p><b>Control Lockout feature is activated</b></p>		<ul style="list-style-type: none"> <li>If LOC ON appears in the display, the oven control is locked. Turn this feature off to use the oven. See the Control Lockout section.</li> </ul>

<b>Problem</b>	<b>Possible Causes</b>	<b>What To Do</b>
<b>Ticking sound of spark igniter persists after burner lights</b>	Control knob is still in the LITE position.	<ul style="list-style-type: none"> <li>• Turn the knob out of the LITE position to the desired setting.</li> <li>• Turn the burner off and relight. If ticking is still present, call for service.</li> </ul>
<b>Burner flames very large or yellow</b>	Improper air to gas ratio.	<ul style="list-style-type: none"> <li>• If range is connected to LP gas, check all steps in the Installation Instructions that came with your range.</li> </ul>
<b>Oven light does not work</b>	Light bulb is loose or defective.	<ul style="list-style-type: none"> <li>• Tighten or replace the bulb.</li> </ul>
	Switch operating light is broken.	<ul style="list-style-type: none"> <li>• Call for service.</li> </ul>
<b>Oven will not work</b>	Plug on range is not completely inserted in the electrical outlet.	<ul style="list-style-type: none"> <li>• Make sure electrical plug is plugged into a live, properly grounded outlet.</li> </ul>
	A fuse in your home may be blown or the circuit breaker tripped.	<ul style="list-style-type: none"> <li>• Replace the fuse or reset the circuit breaker.</li> </ul>
	Oven controls improperly set.	<ul style="list-style-type: none"> <li>• See the Using the oven section.</li> </ul>
	Door left in the locked position.	<ul style="list-style-type: none"> <li>• If necessary, allow the oven to cool; then unlock the door.</li> </ul>
<b>Food does not bake or roast properly</b>	Oven controls improperly set.	<ul style="list-style-type: none"> <li>• See the Using the oven section.</li> </ul>
	Rack position is incorrect or the rack is not level.	<ul style="list-style-type: none"> <li>• See the Using the oven section.</li> </ul>

<b>Problem</b>	<b>Possible Causes</b>	<b>What To Do</b>
	Incorrect cookware or cookware of improper size being used.	<ul style="list-style-type: none"> <li>• See the Using the oven section.</li> </ul>
	Oven thermostat needs adjustment.	<ul style="list-style-type: none"> <li>• See the Adjust the oven thermostat – Do it yourself! section.</li> </ul>
<b>Food does not broil properly</b>	Oven controls improperly set.	<ul style="list-style-type: none"> <li>• Make sure you touch the BROIL HI/LO pad.</li> </ul>
	Improper rack position being used.	<ul style="list-style-type: none"> <li>• See the Broiling Guide.</li> </ul>
	Cookware not suited for broiling.	<ul style="list-style-type: none"> <li>• For best results, use a pan designed for broiling.</li> </ul>
	In some areas the power (voltage) may be low.	<ul style="list-style-type: none"> <li>• Preheat the broil element for 10 minutes.</li> <li>• Broil for the longest period of time recommended in the Broiling Guide.</li> </ul>
<b>Oven temperature too hot or too cold</b>	Oven thermostat needs adjustment.	<ul style="list-style-type: none"> <li>• See the Adjust the oven thermostat – Do it yourself! section.</li> </ul>
<b>Oven door is crooked</b>	The door is out of position.	<ul style="list-style-type: none"> <li>• Because the oven door is removable, it sometimes gets out of position during installation. Remove and replace the oven door. See the Lift-Off Oven Door section.</li> </ul>

<b>Problem</b>	<b>Possible Causes</b>	<b>What To Do</b>
<b>Storage drawer is crooked</b>	Rear drawer support is on top of the guide rail.	<ul style="list-style-type: none"> <li>• Reposition the drawer. See the Storage Drawer Removal instructions in the Care and cleaning of your range section.</li> </ul>
<b>Storage drawer won't close</b>	Rear drawer support is on top of the guide rail.	<ul style="list-style-type: none"> <li>• Reposition the drawer. See the Storage Drawer Removal instructions in the Care and cleaning of your range section.</li> </ul>
<b>Clock and timer do not work</b>	Plug on range is not completely inserted in the electrical outlet.	<ul style="list-style-type: none"> <li>• Make sure electrical plug is plugged into a live, properly grounded outlet.</li> </ul>
	A fuse in your home may be blown or the circuit breaker tripped.	<ul style="list-style-type: none"> <li>• Replace the fuse or reset the circuit breaker.</li> </ul>
	Oven controls improperly set.	<ul style="list-style-type: none"> <li>• See the Using the clock and timer section.</li> </ul>
<b>Oven will not self-clean</b>	Oven controls improperly set.	<ul style="list-style-type: none"> <li>• See the Using the clock and timer section.</li> </ul>
	Oven door is not in the locked position.	<ul style="list-style-type: none"> <li>• Make sure you move the door latch handle all the way to the right.</li> </ul>
<b>“Crackling” or “popping” sound</b>	This is the sound of the metal heating and cooling during both the cooking and cleaning functions.	<ul style="list-style-type: none"> <li>• This is normal.</li> </ul>
<b>Excessive smoking</b>	Excessive soil.	

Problem	Possible Causes	What To Do
<b>during a clean cycle</b>		<ul style="list-style-type: none"> <li>• Touch the CLEAR/OFF pad. Open the windows to rid the room of smoke. Wait until the light on the SELF CLEAN pad goes off. Wipe up the excess soil and reset the clean cycle.</li> </ul>
<b>Oven door will not open after a clean cycle</b>	Oven too hot.	<ul style="list-style-type: none"> <li>• Allow the oven to cool below locking temperature.</li> </ul>
<b>Oven not clean after a clean cycle</b>	Oven controls not properly set.	<ul style="list-style-type: none"> <li>• See the Using the self-cleaning oven section.</li> </ul>
	Oven was heavily soiled.	<ul style="list-style-type: none"> <li>• Clean up heavy spillovers before starting the clean cycle. Heavily soiled ovens may need to self-clean again or for a longer period of time.</li> </ul>
<b>“F—and a number or letter” flash in the display</b>	You have a function error code.	<ul style="list-style-type: none"> <li>• Touch the CLEAR/OFF pad. Put the oven back into operation.</li> </ul>
	If the function code repeats.	<ul style="list-style-type: none"> <li>• Disconnect all power to the range for at least 30 seconds and then reconnect power. If the function error code repeats, call for service.</li> <li>• If a function error code appears during the self-cleaning cycle, check the oven door latch. The latch may have been moved, if only slightly, from the locked position. Make sure the latch is moved to the right as far as it will go. Touch the CLEAR/OFF pad. Allow the oven to cool for one</li> </ul>

Problem	Possible Causes	What To Do
		hour. Put the oven back into operation.
<b>Display flashes “bAd” then “linE” with a loud tone</b>	The installed connection from the house to the unit is miswired.	<ul style="list-style-type: none"> <li>• Contact installer or electrician to correct miswire.</li> </ul>
<b>Control signals after entering cooking time or start time</b>	You forgot to enter a bake temperature or cleaning time.	<ul style="list-style-type: none"> <li>• Touch the BAKE pad and desired temperature or the SELF CLEAN pad and desired clean time.</li> </ul>
<b>Display goes blank</b>	A fuse in your home may be blown or the circuit breaker tripped.	<ul style="list-style-type: none"> <li>• Replace the fuse or reset the circuit breaker.</li> </ul>
	The clock is in black-out mode.	<ul style="list-style-type: none"> <li>• See the Using the clock and timer section.</li> </ul>
<b>Display flashes</b>	Power failure.	<ul style="list-style-type: none"> <li>• Reset the clock.</li> </ul>
<b>Unable to get the display to show “SF”</b>	Oven control pads were not touched properly.	<ul style="list-style-type: none"> <li>• The BROIL HI/LO and BAKE pads must be touched at the same time and held for 3 seconds.</li> </ul>
<b>Power outage, clock flashes</b>	Power outage or surge.	<ul style="list-style-type: none"> <li>• Reset the clock. If the oven was in use, you must reset it by touching the CLEAR/OFF pad, setting the clock and resetting any cooking function.</li> </ul>
<b>“Burning” or “oily” odor</b>	This is normal in a new oven and will disappear in time.	<ul style="list-style-type: none"> <li>• To speed the process, set a self-clean cycle for a minimum of 3</li> </ul>

Problem	Possible Causes	What To Do
<b>emitting from the vent</b>		hours. See the Using the self-cleaning oven section.
<b>Strong odor</b>	An odor from the insulation around the inside of the oven is normal for the first few times the oven is used.	<ul style="list-style-type: none"> <li>• This is temporary.</li> </ul>
<b>Fan noise</b>	A cooling fan may automatically turn on and off.	<ul style="list-style-type: none"> <li>• This is normal. The cooling fan will turn off and on to cool internal parts. It may run after the oven is turned OFF.</li> </ul>

### Warning

This content is compiled from multiple sources and is provided for reference purposes only. It may not be complete or fully applicable to all situations. If you are unable to resolve your issue, please contact the product manufacturer or an authorized service provider for official support.