

Getting started

Features and appearance will vary throughout this manual

1 Load Dishwasher

For best dishwashing results, follow the rack loading guidelines found in the Loading the dishwasher racks section. No pre-rinsing of normal food soil is required. Scrape off hard soils, including bones, toothpicks, skins, and seeds. Remove leafy vegetables, meat trimmings, and excessive amounts of grease or oil. Remove acidic food soils that can discolor stainless steel.

2 Add Detergent

Add needed amount of detergent to the detergent dispenser. Use a detergent such as Cascade Complete All-in-1 ActionPacs™. See Detergent Dispenser in the Using the dishwasher section.

3 Add Rinse Agent

Add Rinse Agent to the rinse agent dispenser. See Use a Rinse Agent such as Cascade® Rinse Aid™ in the Using the dishwasher section.

4 Select Cycle

Press the Select Cycle pad for the desired wash cycle. The light next to the Select Cycle pad will be on to indicate which wash cycle has been selected.

The cycle may be selected with the door in the open position. The cycle will not start until after the door is closed and Start selected.

AutoSense (on some models)	This cycle automatically senses the soil level and adjusts the wash cycle accordingly.
Heavy	This cycle is meant for heavily soiled dishes, cookware, pots, or pans with dried-on or baked-on soils. Everyday dishes are safe to be used in this cycle.
Normal	This cycle is meant for daily, regular, or typical use to completely wash a full load of normally soiled dishes and is designed to conserve both water and energy. NOTE: Normal was used to rate the energy efficiency of this dishwasher.
Light	This cycle is for light to medium soiled dishes. It is safe for china and crystal.
Rinse (on some models)	For rinsing partial loads that will be washed later. Do not use detergent. Detergent is not dispensed during the rinse cycle.

5 Select Options

The light by the selected pad will be ON to indicate which Option has been selected.

Wash Temp Boost (on some models)	This option increases the temperature to help clean heavily soiled dishes and may increase the overall cycle time. Option may be turned On or Off during the wash cycle.
Wash Temp Sani (on some models)	<p>This option raises the water temperature in the final rinse to sanitize your dishware. The cycle length will vary depending on the temperature of your inlet water.</p> <p>NOTE: This option is monitored for sanitization requirements. If the cycle is interrupted during or after the main wash portion or if the incoming water temperature is so low that adequate water heating cannot be achieved, the sanitizing conditions may not be met. In these cases, the Sanitized light will not illuminate at the end of the cycle. Utilizing this option will modify the cycle to meet the requirements of Section 6, NSF 184 for soil removal and sanitization efficacy.</p> <p>NOTE: NSF certified residential dishwashers are not intended for licensed food establishments.</p>
Heated Dry Off	Shuts off the heat drying option. Dishes air dry naturally and energy is saved. Open the dishwasher door to speed drying.
Heated Dry On	Turns on the heater for faster drying. This cycle may extend the time to your wash cycle up to 64 minutes. This option is not available with the Rinse cycle.
Steam (Prewash) on some models	For use with heavily soiled and/or dried-on, baked-on soils. This option MUST be selected PRIOR to starting the cycle. The Steam option adds approximately 30 minutes to the cycle time. This option is available with Heavy, Auto Sense, and Normal cycles.
Wash Zones (on some models)	Selecting either the Upper or Lower Wash Zones will target dishwashing of just one rack. This will shorten the cycle time and conserve energy. This option can be used when there is only half a load of dishes.
Delay Hours (on some models)	Delays the start of a wash cycle up to 8 to 12 hours depending on model. Press Delay Hours, to select the number of hours, then press Start one time to begin countdown. The cycle will start once allotted time has expired.
Control Lock	



	<p>You can lock the controls to prevent selections from being made. You can also lock the controls after you have started a cycle to prevent cycle changes. For example, children cannot accidentally start the dishwasher by pressing pads with this option selected.</p> <p>To LOCK the dishwasher control, depending on the model, press and hold the Heated Dry pad for 3 seconds or press and hold the Steam and Wash Temp pads at the same time for 3 seconds. The Control Lock light will turn on to indicate the control is locked.</p> <p>To UNLOCK the dishwasher control, depending on the model, press and hold the Heated Dry pad for 3 second or press and hold the Steam and Wash Temp pads at the same time for 3 seconds. The Control Lock light will turn off to indicate the control is unlocked.</p>
Energy Smart	<p>When connected to a smart meter and your electric company, the dishwasher will automatically delay starting a cycle during the more expensive peak demand times, and run when demand is low. However, you can override the delay settings and use the dishwasher as needed. Learn more about Energy Smart under the Using the Dishwasher section.</p>

6 Start Dishwasher

Start	<p>Door can be open to select the desired options. Press the Start pad and close the door within 10 seconds to start the cycle or begin the Delay Hours countdown. The wash cycle will begin shortly after closing the door. If the door is open, the illuminated lights will turn off if a pad is not pressed within two minutes.</p> <p>To activate the display, close and open the door or press any pad.</p>
Interrupt or Pause	<p>To interrupt or pause a dish cycle, slowly open the door. Opening the door will cause the wash cycle to pause. The dishwasher will beep every minute to remind you to close the door. To restart or resume the cycle, press Start, and close the door.</p>
Cancel	<p>To cancel a wash cycle, press and hold the Start pad for 3 seconds and close door. The dishwasher will drain, emit a beep sound, and the wash cycle light will turn OFF.</p>

7 Cycle Completion

Sanitized	Displayed at the end of the cycle when Wash Temp Sani (Sanitize) has been selected and the dishwasher has met the requirements for sanitization. See Wash Temp Sani, for complete option description. Opening the door or pressing any key while the door is closed will turn off the light.
Clean	Displayed when a wash cycle is complete. The light stays ON as a reminder that the dishes are clean. Opening the door or pressing any key while the door is closed will turn the light off.
Door Wake Up Mode (on some models)	To turn this option ON/OFF, press and hold the START and WASH TEMP pads for 5 seconds, close the door and wait 3 minutes for the dishwasher to go into sleep mode. In the OFF mode, the control display, control sounds, and interior lights will not respond to the door opening/closing. This mode can be used when observing certain religious holidays such as the Sabbath. To activate the control and interior lights, press any pad.

Using the dishwasher.

Check the Water Temperature

The entering water should be at least 120°F (49°C) and not more than 150°F (66°C) for effective cleaning and to prevent dish damage. Check the water temperature with a candy or meat thermometer. Turn on the hot water faucet nearest the dishwasher, place the thermometer in a glass and let the water run continuously into the glass until the temperature stops rising.

Energy Smart

Energy Smart enables your dishwasher to reduce energy consumption during periods of high energy costs. If you are in an area where your electricity provider charges variable rates at different times of the day, your dishwasher will inform you of those times when you are paying the highest rate. You can then either delay starting your dishwasher until the rate goes down; or you can override the feature and run your dishwasher at your convenience.

What you will need:

1. Smart Meter that will communicate with your dishwasher. Consult your local electricity provider to determine if the technology is available in your area.
2. An Energy Smart dishwasher model (ADT521, GDF520, GDF540, GDT530 or GDT550).

Use a Rinse Agent such as Cascade® Rinse Aid™

Rinse agents, such as Cascade® Rinse Aid™ are designed for great drying action and protect against spots and film build-up on your dishes, glasses, flatware, cookware, and plastic.

Filling the Dispenser

The rinse agent dispenser holds 3.5 oz. (100 ml) of rinse agent. Under normal conditions, this will last approximately one month.

1. Make sure the dishwasher door is fully open.
2. Open the RINSE AID dispenser door.
3. Slowly add rinse agent until the fill cup is full. May need to pause several times to allow rinse aid to settle.
4. Clean up any spilled rinse agent with a damp cloth.
5. Close the RINSE AID dispenser door.

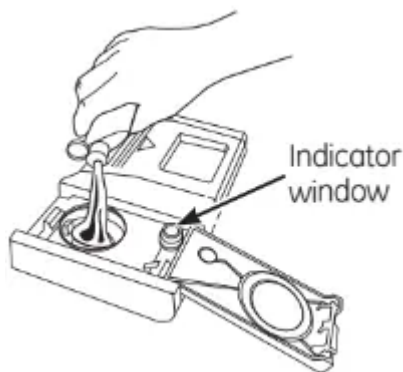

Rinse Aid Setting

The amount of rinse agent released into the final wash can be adjusted. The factory setting is at the midpoint. If hard water spots appear on dishes, try a higher setting. If you see foam in the dishwasher, move the indicator to a lower setting.



To adjust the setting

Open the RINSE AID dispenser door; then turn the adjuster clockwise to increase the amount of rinse agent, counterclockwise to reduce the amount of rinse agent.

Detergent Dispenser

The detergent dispenser is located in the center of the dishwasher door. It has two compartments. The main wash compartment is found inside the detergent dispenser. To open, press the blue button on the side of the dispenser. The pre-wash compartment is on the lid of the detergent dispenser. Use the pre-wash compartment only when your water is extremely hard or when you have a heavy soiled load.

NOTE: Do not block detergent dispenser with large or tall utensils.

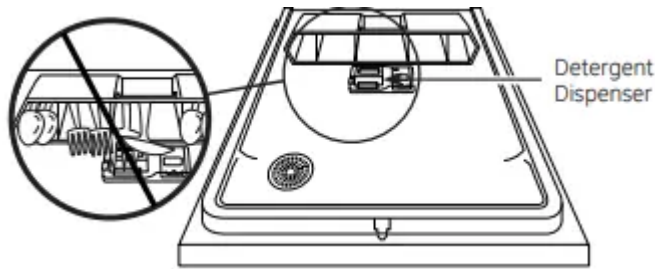

You may use tablet, powder, liquid or gel automatic dishwasher detergent. Make sure you use only detergents specifically labeled for use in automatic dishwashers. Never use liquid hand dish detergent in an automatic dishwasher. Sudsing and poor wash performance will result with the use of improper detergents.

Detergents should be stored in a dry location and in their original container to prevent loss of effectiveness. Place detergent in the cup just prior to starting the dishwasher and then close the cover. The cover will open during the wash cycle.

Filling the Detergent Dispenser

GE recommends using detergent in tablet or packet form. Independent testing has shown this form of detergent is very effective in the dishwasher. Cascade® All-in-1 ActionPacs™ are an example of this type of detergent. Simply put a tablet or packet into the main wash compartment and slide to close the detergent cup cover. Please notice that the tablet or packet must be placed in the main wash compartment of the detergent cup. If the tablet or packet is tossed in the bottom of the dishwasher, the detergent will be flushed down the drain in a very short period of time and will thus be wasted. Wash performance will be very poor as a result.

If you choose to use detergent in powder, liquid or gel form, the amount of detergent you use will be determined by the hardness of your water, the temperature of your water, and the food soil load inside the dishwasher. Contact your water company to get information about the hardness of the water in your area. Water hardness is measured in grains per gallon. Use this information and the table above to determine the amount of detergent to use. You may purchase a hard water test strip from GE. Call 1-877-959-8688 and ask for part number WD01X10295. In Canada, call 1-800-661-1616.

<i>Number of Grains/Gal.</i>	<i>Detergent Cups to Fill</i>
Less than 4	Fill cup to 1/3 full
4 to 8	Fill cup to 2/3 full
8 to 12	Fill cup completely full
Greater than 12	Fill both main wash cup and pre wash cup

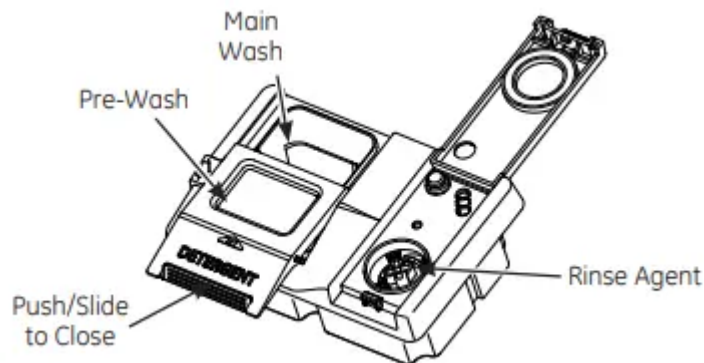

Using too much detergent with very soft and/or very hot water may cause a condition called etching on your glassware. Etching is a permanent cloudiness in your glassware. This condition is irreversible. However, using too little detergent will cause poor wash performance.

Use the table as a starting point and then adjust the amount of detergent you use. Use just enough to get good wash performance. Using just the right amount of detergent will provide great wash performance without wasting detergent or etching of glassware.

DO NOT USE HAND DISH DETERGENT

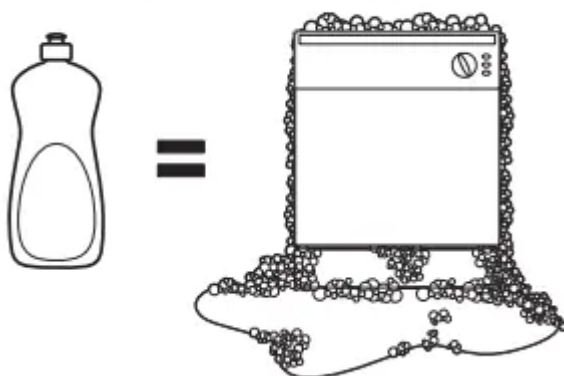

NOTE: Using a detergent that is not specifically designed for dishwashers will cause the dishwasher to fill with suds. During operation, these suds will spill out of the dishwasher vents, covering the kitchen floor and making the floor wet.

Because so many detergent containers look alike, store the dishwasher detergent in a separate space from all other cleaners. Show anyone who may use the dishwasher the correct detergent and where it is stored.

While there will be no lasting damage to the dishwasher, your dishes will not get clean using a dishwashing detergent that is not formulated to work with automatic dishwashers.

Loading and place settings.

For best dishwashing results, follow these loading guidelines. Features and appearance of racks and silverware baskets may vary from your model.

Upper Rack



The upper rack is primarily for glasses, cups, and saucers. However, other items such as pots, pans, and plates may be placed in the upper rack. This is also a secure place for dishwasher-safe plastic items. The upper rack can be used for odd sized utensils. Sauce pans, mixing bowls, and other similarly shaped items should be placed face down for best wash performance. Ensure small plastic items are secure so that they cannot fall into the heater at the bottom of the dishwasher, potentially damaging the item.

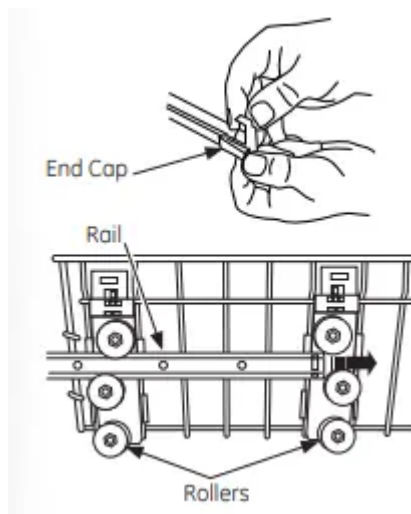

On some models, the upper rack may be adjusted to accommodate larger items. To adjust the upper rack, fully extend the upper rack and remove the two plastic end caps on the front of the rails. Remove the upper rack. Select the set of rollers on the side of the rack that provides the desired height, and reinstall the upper rack by guiding the rack rails between the appropriate set of rollers. With the rack reinstalled, replace the two plastic end caps, ensuring the snap is properly engaged. Failure to properly engage the end caps may result in the rack falling from the dishwasher.

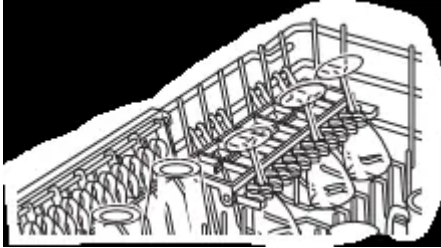

To add flexibility in loading, the utility shelf (on some models) may be placed in the up or down position. The shelf may also be used to secure stemware such as wine glasses. Because these stemware items come in various sizes, slowly push the rack in to ensure the items do not bump into the edges of the dishwasher, which may cause damage to the items.

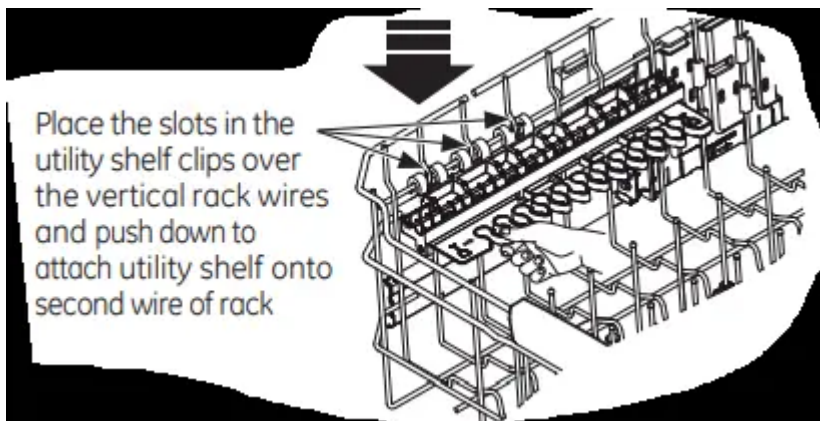

It is important to ensure that items do not protrude through the bottom of the rack or silverware basket (on some models) where they will block the rotation of the middle spray arm. This could result in noise during operation and/or poor wash performance.



Check to make sure that no items will block rotation of the wash arms.

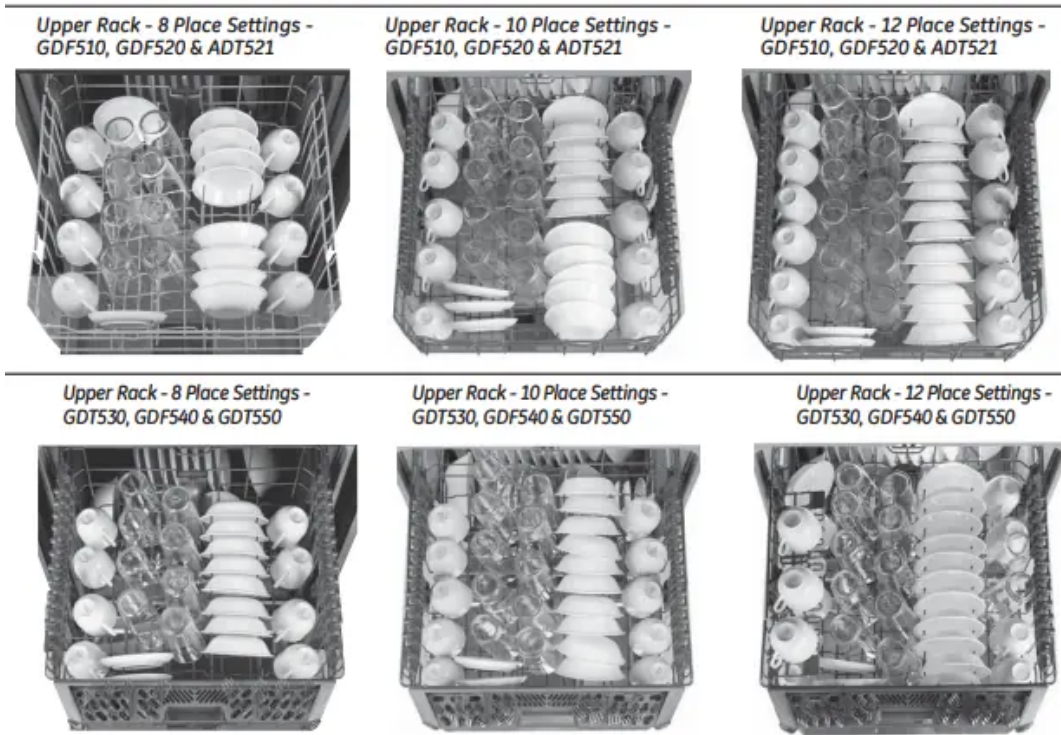

Lower Rack

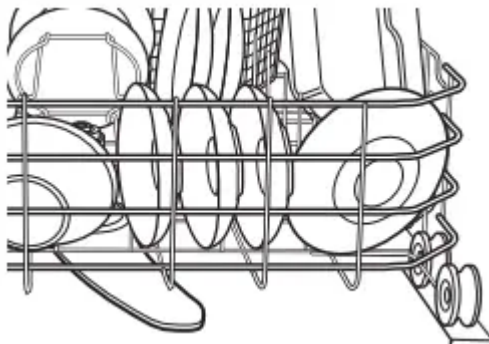

The lower rack is best used for plates, saucers and cookware items. Large items, such as broiler pans and baking racks should go along the sides of the rack. If necessary, oversized glasses and mugs can be placed in the lower rack to maximize loading flexibility. Plates, saucers and similar items should be placed between the tines in the direction that allows the item to remain secure in the rack.

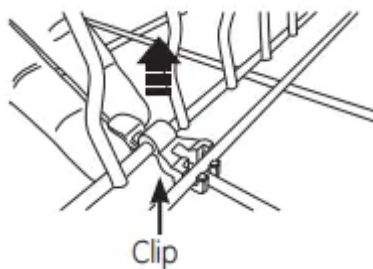

Do not load large items where they may block the detergent dispenser when the door is closed.

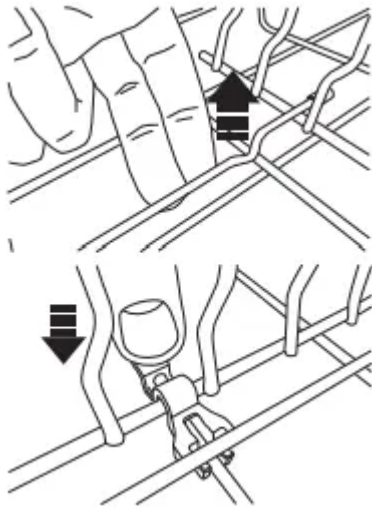

The reversible tine blocks (on some models) are designed to allow greater flexibility in loading dishes. The direction of the tine blocks can be changed to match preferred loading direction. To adjust the tine block direction, remove the clips securing the tine blocks to the racks by pulling up on the tab, then flex the retaining wire to unseat the tine block from the lower rack. The tine block may be turned in the opposite direction to reverse the loading direction. Secure the tine block to the rack using the same process and be sure to snap the same clips in place.

WARNING! The clips can be a choke hazard for small children if removed from the dishwasher. Keep out of reach of children.

Fold down tines (on some models) allow for greater flexibility in loading large items. Select the position of the fold down tine that best accommodates your dishware items. The direction of the fold down tines can be changed to match preferred loading direction. To adjust the fold down tine direction, remove the clips securing the fold down tines to the racks by sliding the clip so that it disengages from the rack wire. The fold down tines may be rotated in the opposite direction to reverse the loading direction. Secure the fold down tines to the rack using the same clips. The clip is removed by pulling up on the clip and separating it from the rack. Replace the clip on the opposite side of the rack by positioning the clip over the wire and pressing down.

It is important to ensure that items do not protrude through the bottom of the rack or the silverware basket where they will block the rotation of the lower spray arm. This could result in noise during operation and/or poor wash performance.

*Lower Rack - 8 Place Settings -
GDF510, GDF520 & ADT521*



*Lower Rack - 10 Place Settings -
GDF510, GDF520 & ADT521*

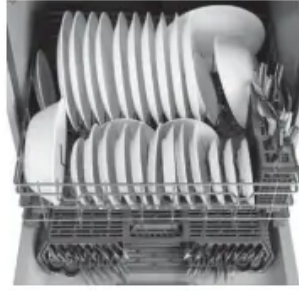

*Lower Rack - 12 Place Settings -
GDF510, GDF520 & ADT521*



*Lower Rack - 8 Place Settings -
GDT530, GDF540 & GDT550*



*Lower Rack - 10 Place Settings -
GDT530, GDF540 & GDT550*



*Lower Rack - 12 Place Settings -
GDT530, GDF540 & GDT550*



Loading the silverware baskets...

For best dishwashing results, follow these loading guidelines. Features and appearance of racks and silverware baskets may vary from your model.

Silverware Basket

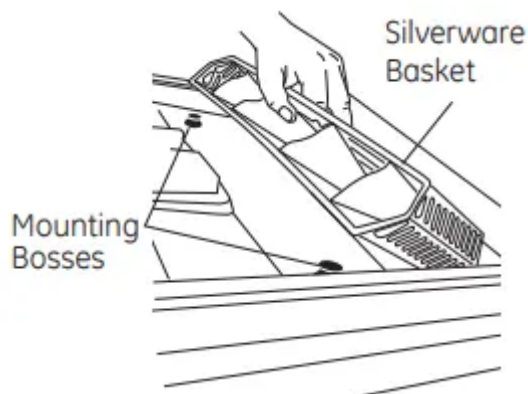

Place flatware in the removable silverware and accessory baskets (on some models). Sharp objects, such as forks and knives, may be placed with the handles facing up, in order to protect your hands. For the best wash performance, place other items such as spoons with the handles facing down. Avoid allowing items to nest together, which may keep them from being properly washed. When loading, distribute items evenly in the basket.

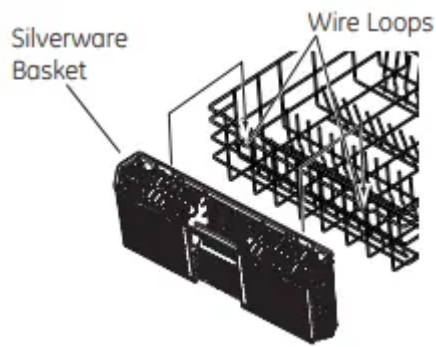

The silverware and accessory baskets (on some models) may also be used for small items, such as measuring spoons, baby bottle nipples, plastic lids, or corn cob holders. The silverware basket covers (on some models) can be closed to contain small items.

The door mounted silverware basket (on some models) may be positioned either on the door by securing the basket to the door using the two mounting bosses, or to the rack by securing the basket to the rack using the wire loop on the front of the lower rack to engage the tabs on the rear of the basket.

The accessory basket (on some models) may be positioned by placing the hooks on the back of the basket over the top wire on the sides of the lower rack.

The FlexBaskets (on some models) may be positioned on the front of either the upper or lower racks.

Secure the basket to the rack using the wire loop on the front of the upper and lower racks to engage the tabs on the rear of the basket.

Do not load large or tall utensils where they may block the detergent dispenser or become trapped between the door and the gasket when the door is closed.

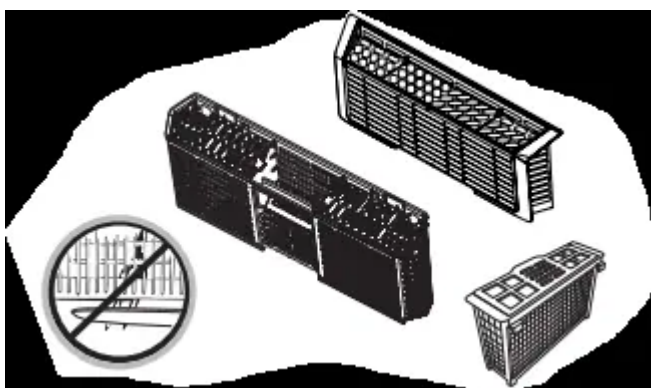

*Silverware Basket - 8 Place Settings -
GDF510, GDF520 & ADT521*

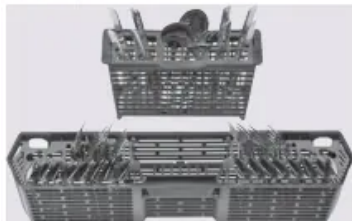

*Silverware Basket - 10 Place Settings -
GDF510, GDF520 & ADT521*



*Silverware Basket - 12 Place Settings -
GDF510, GDF520 & ADT521*



*Silverware Basket - 8 Place Settings -
GDT530, GDF540 & GDT550*

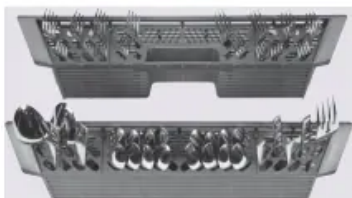

*Silverware Basket - 10 Place Settings -
GDT530, GDF540 & GDT550*

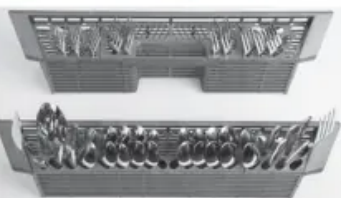

*Silverware Basket - 12 Place Settings -
GDT530, GDF540 & GDT550*

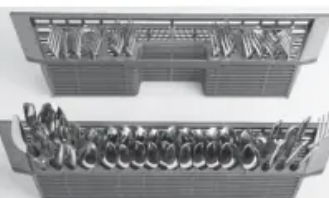

Care and cleaning.

Cleaning the Exterior Door Panel

Before cleaning the front panel, make sure you know what type of panel you have. Refer to the last two letters of your model number. You can locate your model number on the left-hand tub wall just inside the door. If your model number ends with BB, CC, WW, SA or ES then you have a painted door panel. If your model number ends with SS, then you have a Stainless Steel Door panel. If your model number ends with II, then you have an Integrated door panel.

Follow the instructions below for cleaning the door panel for your specific model.

Painted Door Panel (model numbers ending in BB– black, CC–bisque, WW–white, SA–silver or ES–slate)

Use a clean, soft, lightly dampened cloth, then dry thoroughly. You may also use a good appliance wax or polish.

Stainless Steel Door Panel (model numbers ending in SS)

For cleaning rust and tarnish, cleaners with oxalic acid such as Bar Keepers Friend Soft Cleanser™ will remove rust, tarnish and small blemishes. Use only a liquid cleanser free of grit and rub in the direction of the brush lines with a damp soft sponge. Do not use appliance wax or polish on the stainless steel.

For other blemishes and marks, use Stainless Steel Magic or a similar product using a clean soft cloth. Do not use appliance wax, polish, bleach or products containing chlorine on Stainless Steel. You can order Stainless Steel Magic # WX10X29 through GE Parts by calling 877.959.8688. In Canada, call 1-800-661-1616.

Integrated Door Panel (model numbers ending in II) This is a custom installed door panel, and you will need to refer to the cabinet manufacturers recommendations for proper cleaning

Do not use scouring pads or powered cleaners because these products can scratch the finish.

Cleaning the Control Panel

To clean the control panel, use a lightly dampened soft cloth. Then dry thoroughly.

Stainless Steel Inner Door

The stainless steel used to make the dishwasher tub and inner door provides the highest reliability available in a GE dishwasher.

If the dishwasher tub or inner door should be scratched or dented during normal use, they will not rust or corrode. These surface blemishes will not affect their function or durability.

Cleaning the Filters

Inspect the filters periodically, every other month or so depending on usage, and clean if necessary. If there is a decrease in wash performance or dishes feel gritty, this is also an indication the filters need to be cleaned.

Ultra-Fine Filter

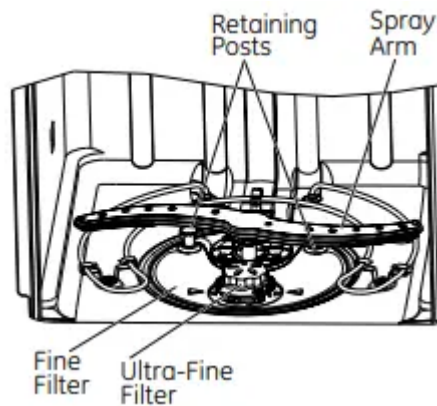

To clean the Ultra-Fine Filter, remove the bottom rack. Twist and remove the large round filter. Rinse filter with warm soapy water and use a sponge to carefully remove any stubborn particles. Scrubbing with scouring pads or brushes can damage the filter. Once cleaned, replace the Ultra-Fine Filter, and twist to lock in place.

Fine Filter

To clean the Fine Filter (mesh plate), remove the bottom rack. Remove the Ultra-Fine Filter. Twist each of the two retaining posts located toward the back bottom of the tub, and remove the Fine Filter. Rinse filter with warm soapy water. Scouring pads or brushes can damage the filter but a soft brush or sponge may be needed to remove stubborn soils or calcium deposits caused by hard

water. Once cleaned, replace the Fine Filter, the Ultra-Fine Filter, and twist the two retaining posts into place.

WARNING! The retaining posts can be a choke hazard for small children if removed from the dishwasher. Keep out of reach of children.

Protect Against Freezing

If your dishwasher is left in an unheated place during the winter, ask a service technician to:

1. Cut off electrical power to the dishwasher. Remove fuses or trip circuit breaker.
2. Turn off the water supply and disconnect the water inlet line from the water valve.
3. Drain water from the water inlet line and water valve. (Use a pan to catch the water.)
4. Reconnect the water inlet line to the water valve.

Does Your Dishwasher Have an Air Gap?



An air gap protects your dishwasher against water backing up into it if a drain clogs. The air gap is not a part of the dishwasher. It is not covered by your warranty. Not all plumbing codes require air gaps, so you may not have one.

The air gap is easy to clean.

1. Turn off the dishwasher and lift off the cover.
2. Remove the plastic cap and clean with a toothpick.

Before you call for service...

Troubleshooting Tips

Problem	Possible Causes	What To Do
Start Status indicator light flashing	The door was opened or the cycle was interrupted.	Press the Start pad once to start the dishwasher. Press the Start pad a second time when the dishwasher is running only if you wish to cancel the cycle.
Dishwasher BEEPS once every minute	This is a reminder that your dishwasher door has been left open during operation. It will continue beeping until you press Start and close the door.	Press Start and close the door.
Beeping at the end of the cycle (on some models)	This is normal. The dishwasher will beep twice at the end of the cycle.	To turn off the double beep indicator (or re-activate it if it was previously turned off), press the Heated Dry pad 5 times within 3 seconds. A triple beep will sound to indicate the end-of-cycle beep option has been turned on or off.
Dishes and flatware not clean	Ultra fine or fine filter is clogged	See the Care and cleaning section.
	Low inlet water temperature	Make sure inlet water temperature is correct (see the Using the dishwasher section). Turn on the hot water faucet nearest the dishwasher, let run until the water temperature stops rising. Then start the dishwasher and turn off the faucet. This ensures the entering water is hot. Select Wash Temp Boost if available.
	Water pressure is temporarily low	Turn on a faucet. Is water coming out more slowly than usual? If so, wait until pressure is normal before using your dishwasher.
	Air gap or disposer is clogged	Clean the air gap or flush the disposer.

	Improper rack loading	<p>Make sure large dishware does not block the detergent dispenser or the wash arms. See the Loading the dishwasher racks section.</p> <p>When large utensils are placed in the silverware basket, do not mount the basket on the door (on some models). Instead, mount basket on the lower rack.</p>
	Poor performing detergent	Use a highly rated detergent such as Cascade Complete ® All-in-1 ActionPacs™.
Spots and filming on glasses and flatware	Extremely hard water	<p>Use rinse agents such as Cascade ® Rinse Aid™ to remove spots and prevent new film buildup.</p> <p>If water is extremely hard, a softener may be required.</p>
	Low inlet water temperature	Make sure water temperature is at least 120°F.
	Overloading or improper loading of the dishwasher	Load dishwasher as shown in the Loading Place Settings section.
	Old or damp powder detergent	Make sure detergent is fresh.
	Rinse agent dispenser empty	Refill with rinse agent such as Cascade ® Rinse Aid™.
	Too little or low performing detergent	Make sure you use the proper amount of highly rated detergent.
Cloudiness on glassware	Combination of soft water and too much detergent	This is called etching and is permanent. To prevent this from happening, use less detergent if you have soft water. Wash glassware in the shortest

	Low performing phosphate free detergent	See A white film on glassware, dishware and the interior in this Troubleshooting section.
	Water temperature entering the dishwasher exceeds 150°F (66°C)	This could be etching. Lower the water heater temperature.
Suds in the tub	<p>Correct detergent wasn't used.</p> 	<p>Use only automatic dishwasher detergents to avoid sudsing. Cascade® Automatic Dishwashing Detergents have been approved for use in all GE dishwashers.</p> <p>To remove suds from the tub, open the dishwasher and let suds dissipate. Pump out water by pressing Start and close the door. Wait 30 seconds. Open the door, press and hold Start for 3 seconds, and close the door. Repeat if necessary.</p>
	Rinse agent was spilled	Always wipe up rinse agent spills immediately.
Detergent left in dispenser cups	Dishes or utensils are blocking the detergent cup	<p>Reposition the dishes, so the water from the lower spray arm can flush the detergent cup. See the Loading the dishwasher racks section.</p> <p>Reposition the tall utensils or heavy silverware that may be keeping the dispenser cup door from opening. See the Loading the silverware basket section.</p>
Black or gray marks on dishes	Aluminum utensils have rubbed against dishes	Remove marks with a mild, abrasive cleaner.
Dishes don't dry	Low inlet water temperature	Make sure inlet water temperature is at least 120°F.

		<p>Select Heated Dry.</p> <p>Use Wash Temp Boost option.</p> <p>Select a higher cycle, such as Wash Temp Sani (Sanitize) or Heavy.</p>
	Rinse agent dispenser is empty	Check the rinse agent dispenser and fill as required.
Control panel responded to inputs but dishwasher never filled with water	Door may not be completely closed	Make sure the door is firmly closed.
	Water valve may be turned off	Make sure water valve (usually located under the sink) is turned on.
Stained tub interior	Some tomato-based foods can cause reddish stains	Use of the Steam cycle (on some models) after adding the dish to the load can decrease the level of staining.
	Tea or coffee stains	<p>Remove the stain by hand, using a solution of 1/2 cup bleach and 3 cups warm water. NOTE: Do not use bleach on stainless steel tub or inner door.</p> <p>CAUTION! Before cleaning interior, wait at least 20 minutes after a cycle for the heating elements to cool down. Failure to do so can result in burns.</p>
	An overall yellow or brown film can be caused by iron deposits in water	A special filter in the water supply line is the only way to correct this problem. Contact a water softener company.



	White film on inside surface— hard water minerals	<p>GE recommends Cascade® Rinse Aid™ to help prevent hard water mineral deposits from forming.</p> <p>Run dishwasher with citric acid to remove mineral deposits. Citric acid (Part number: WD35X151) can be ordered through GE Parts. See back cover for ordering information.</p>
Dishwasher won't run	Fuse is blown or circuit breaker is tripped	Replace fuse or reset circuit breaker. Remove any other appliances from the circuit.
	Power is turned off	In some installations, the power to the dishwasher is provided through a wall switch, often located next to the disposer switch. Make sure it is on.
	Control panel is locked	Unlock control panel. See the Getting started section.



Control panel lights go off when you're setting controls	Time too long between touching of selected pads	Each pad must be touched within 30 seconds of relight, touch any pad again or open the door and control).
Water standing in the bottom of the tub	Air gap is clogged	Clean the air gap. See the Care and cleaning section.
Water won't pump out of the tub	Drain is clogged	If you have an air gap, clean it. See the Care section. If the dishwasher drains into a disposer, run disposer. Check to see if your kitchen sink is draining well. If need a plumber.
Steam	This is normal	Warm, moist air comes through the vent during drying water is being pumped out. This is necessary for drying.
Sanitized light does not illuminate at the end of the cycle	The door was opened and the cycle was interrupted during final rinse	Do not interrupt the cycle by opening the door during cycle.
	The incoming water temperature was too low	Raise the water heater temperature to between 120°F and 150°F.
Noise	Normal operating sounds: Detergent cup opening Water entering dishwasher	These are all normal. No action is required.
	The motor stops and starts at various times during the cycle	
	Spray arms start and stop at various times	



	Drain pump sounds during pump out	
	Drain pump starts and stops several times during each drain	
	Rattling dishes when the spray arm rotates	Make sure dishes are properly loaded. See the Load dishwasher racks section.
	Rattling silverware against door during wash	Tall utensils may be placed in the upper rack to avoid against inner door during wash cycle.
A white film on glassware, dishware and the interior	This problem caused by phosphate-free dishwasher detergent	<p>To remove the white film, run your dishes through a cycle with citric acid. Use a WD35X151 citric acid kit online.</p> <p>Pour the citric acid in the detergent cup and close the lid. Place the filmed but otherwise clean glassware and dishware in the dishwasher. Leave silverware and other metal items in the dishwasher. Turn the dishwasher on and let it run a complete cycle without detergent. The glassware, dishes and dishwasher should come out film free. Alternatively, a vinegar rinse may be used. Pour 1 cup of vinegar into dishwasher after the detergent cup opens and let the dishwasher finish its cycle.</p> <p>This may be repeated several times a year as needed.</p> <p>The use of a rinse agent such as Cascade® Rinse helps help minimize a repeat build up of film. Also, the use of a phosphate rated detergent such as Cascade Complete® All-in-One ActionPacs™ will help prevent film build-up.</p>

Warning

This content is compiled from multiple sources and is provided for reference purposes only. It may not be complete or fully applicable to all situations. If you are unable to resolve your issue, please contact the product manufacturer or an authorized service provider for official support.



