

IDENTIFICATION OF PARTS

Front

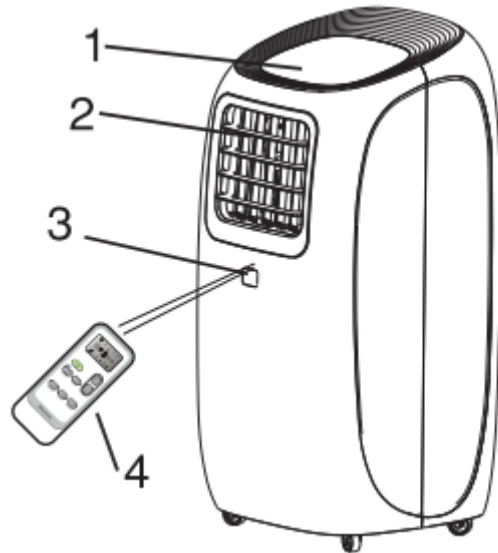

Back

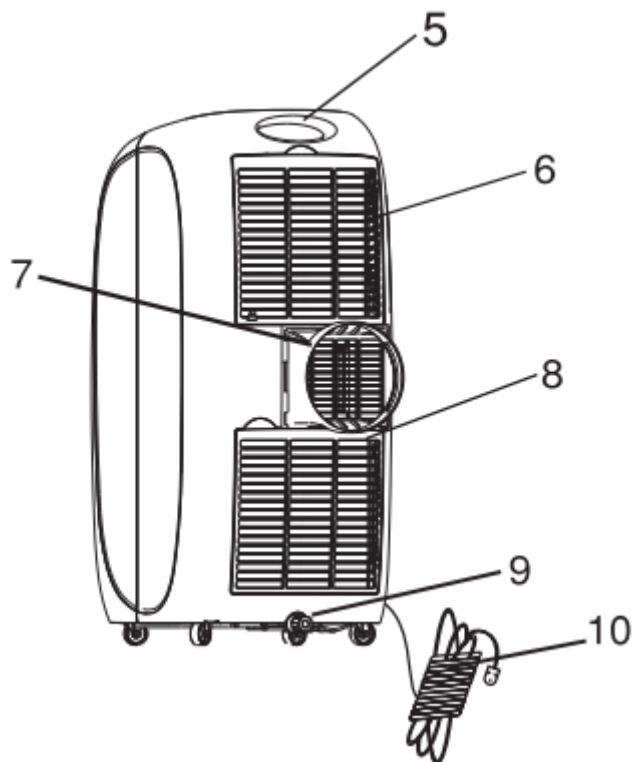

1. Control
2. Cool air outlet
3. Signal receptor

4. Remote control
5. Transport handle
6. Evaporator air intake
7. Air outlet hose coupling
8. Condenser air intake
9. Primary drain port
10. Power cord

PORTABLE AIR CONDITIONER USE

Operating your portable air conditioner properly helps you to obtain the best possible results.

This section explains proper air conditioner operation.

IMPORTANT:

- Do not stay in direct airflow from the air conditioner for extended periods of time.
- Never use in tightly enclosed spaces. Always ensure there is sufficient airflow of outside air entering the household especially when used in conjunction with combustible devices such as gas stoves, fireplaces, furnaces, hot water heaters etc. Do not place the power cord or air conditioner near a heater, radiator, stoves or other apparatus (including amplifiers) that produce heat.
- This air conditioner is intended for household use as a residential appliance. Do not use it as a precision climate control for commercial use, or for precision equipment, food, pets, plants, artwork, etc.
- Do not block or obstruct the exhaust vent hose as it may severely affect performance, or cause failure of the air conditioner.
- The air conditioner display shows the current room temperature.
- When changing modes while the air conditioner is in operation, the compressor will stop for 3 to 5 minutes before restarting. If a button is pressed during this time, the compressor will not restart for another 3 to 5 minutes.
- In Cooling or Dry mode, the compressor and condenser fan will stop when the room temperature reaches the set temperature.
- On Dry mode, the humidity level is automatically set, but is not able to be displayed.

NOTE: In the event of a power failure, your air conditioner will operate at the previous settings when the power is restored.

Starting Your Portable Air Conditioner

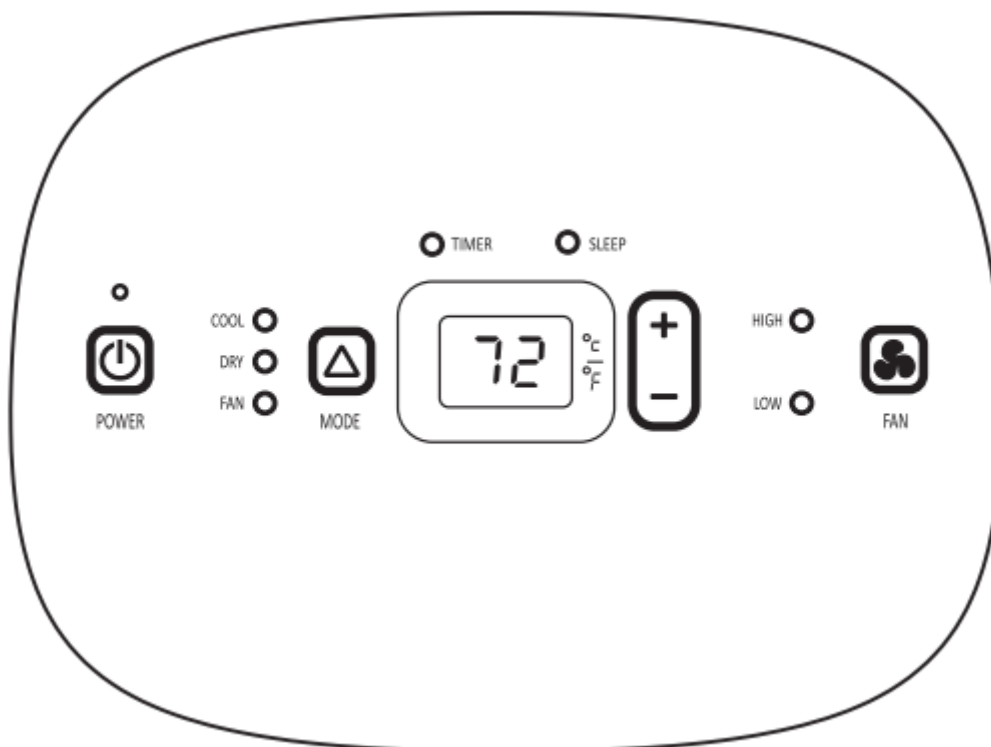

Power On or Off



NOTE: Keep upright at least 2 hours before use to prevent damaging the compressor.

At the first time when the air conditioner is plugged in and turned on after your purchase, it will be set in Cool Mode. When the air conditioner is turned on at all other times, it will run according to the previous setting.

Mode

1. Press and release MODE until you see the symbol for the desired setting.

Operating modes:



2. Choose Cool, Dry, or Fan.

Cooling-Cools the room. Press FAN to select High or Low speeds. Press the Plus or Minus button to adjust the temperature.

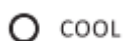

Dry-Dries the room. The air conditioner automatically selects the temperature. The fan runs on Low speed only. Dehumidification ranges between 2 to 3 pints per hour by model.

NOTE: Dry mode should not be used to cool the room. DRY

Fan Only mode. Press FAN to select High or Low. FAN

Fan Speed

1. Press and release FAN to choose the desired fan speed.



FAN

2. Choose High or Low.

High-for maximum fan speed HIGH

Low-for minimum fan speed LOW

Temperature

Press the PLUS (+) button to raise the temperature. Press the PLUS button once to increase the set temperature by 1°F (1°C).

Press the MINUS (-) button to lower the temperature. Press the MINUS button once to decrease the set temperature by 1°F (1°C).

NOTE:

- In the Cooling mode, the temperature can be set between 61°F and 86°F (16°C and 30°C).
- In Fan Only mode, the temperature can not be set.
- The unit LED shows the target temperature for 5 seconds and then displays the room temperature.

Change display between °F and °C

To change the temperature display between °F and °C press both the Plus and Minus Adjust buttons at the same time.

Using the Remote Control

Insert the Batteries

1. Remove the battery cover along the arrowed direction.

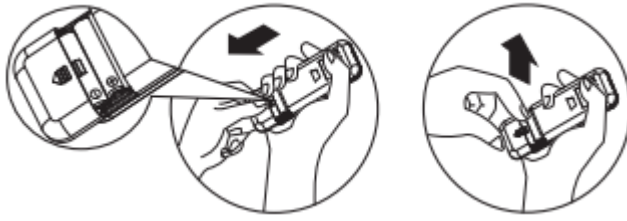

2. Insert new batteries making sure that the (+) and (-) of battery are matched correctly.

3. Re-attach the cover by sliding it back into position.



NOTE:

- Use 2 standard AAA(1.5volt) batteries. Do not use rechargeable batteries.
- Replace batteries with new ones of the same type when the display becomes dim, or after 6 months.
- When replacing batteries, always replace both batteries with new batteries. Do not mix old and new batteries. Do not mix alkaline, standard(carbon-zinc), or rechargeable (ni-cd, ni-mh, etc) batteries.
- If the air conditioner will not be used for an extended period of time, remove the batteries from the remote.

CAUTION: Do not use the remote if the batteries have leaked. The chemicals in batteries could cause burns or other health hazards.

Storage Tip

The holder on the back of the unit can be used to store the remote control.

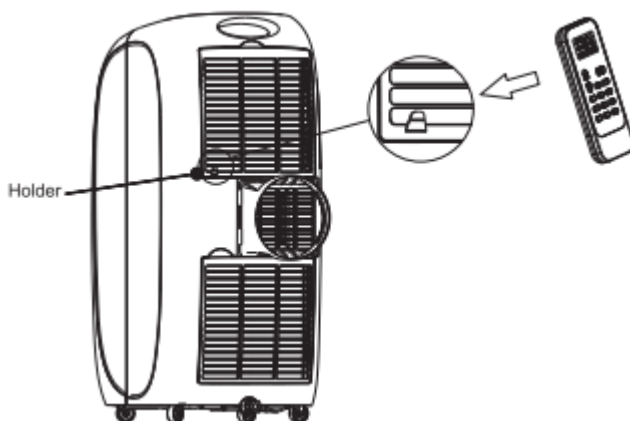

How to Use



To operate the room air conditioner, aim the remote control at the signal receptor. The remote control will operate the air conditioner at a distance of up to 23'(7m) when pointing at signal receptor of the air conditioner.

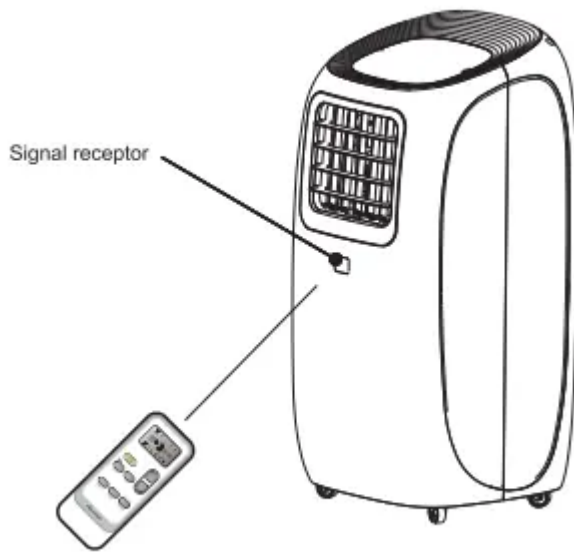

Remote control

NOTE: Remote control may differ in appearance.

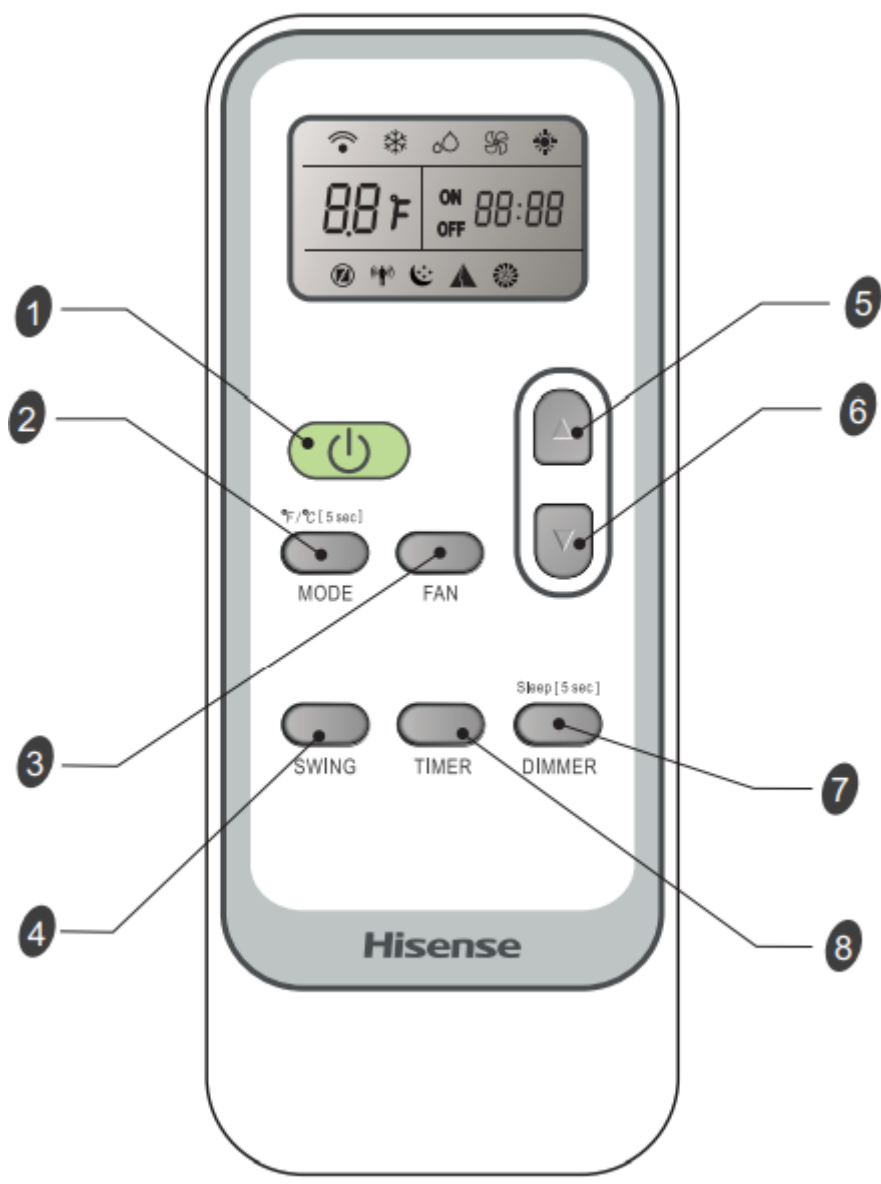

Button and Function









1		ON/OFF	5		UP
2		MODE	6		DOWN
3		FAN	7		DIMMER or Sleep
4		SWING	8		Timer On/Off



NOTE: Press and hold the MODE button on the remote for 5 seconds to switch the temperature display from degrees Fahrenheit (°F) to degrees Celsius (°C).

Indication symbols



Indication symbols on LCD:

 Cooling indicator	 Auto fan speed
 Dry indicator	 High fan speed
 Fan only indicator	 Medium fan speed
 Heating indicator	 Low fan speed

 Sleep indicator
 Signal transmit.
 8.8 F Display set temperature

DIMMER



Press the DIMMER button to turn off the control panel display.

NOTE: When in DIMMER mode, new control inputs will return display to normal.

Sleep mode

SLEEP mode can only be set in Cooling, Heating or Drying modes. When in sleep mode the unit will utilize lower, quieter fanspeeds and automatic temperature adjustments offering 8 hours of optimal sleeping conditions before shutting off.



NOTE:

- The appliance will stop operation automatically after operating for 8 hours.
- Fan speed is automatically set at low speed.
- In the Cooling mode, if the current room temperature is below 79°F(26°C), the temperature will automatically increase 1°F(1°C) during the first hour after Sleep control is activated, and continue running at that temperature. If the room temperature is 79°F(26°C) or above, set temperature will not change.

- In Heating mode, the set temperature will decrease by 6°F(3°C) at most, during 3 hours, and continues running at that temperature until auto shut off.

1. Press MODE to select COOL, Heating or DRY.

NOTE: Sleep control cannot be selected in Fan mode.

2. Press the UP or DOWN button to set the temperature.

3. Press and hold the DIMMER button on the remote for 5 seconds to switch the DIMMER mode to the Sleep mode.

4. After 5 seconds, the lights on the control panel display will dim.

NOTE: The temperature and airflow direction may be adjusted during Sleep control. The fan speed is automatically set to Low speed. After 5 seconds, the lights on the control panel display will dim again.

5. To turn off Sleep control, press MODE, FAN, Sleep or wait 8 hours for Sleep control to turn off automatically.

NOTE: The air conditioner will return to previous settings after Sleep mode is turned off.

TIMER

Use the TIMER function to turn the air conditioner ON/OFF automatically.



Setting the Air Conditioner to Turn On:

1. Plug in the air conditioner and use the remote to power it ON.
2. Use the remote to set the desired mode, temperature, fan speed, etc.
3. Use the remote to power OFF the air conditioner.
4. Press TIMER on the remote and use the UP, DOWN buttons to set the desired delay time until the air conditioner turns ON. The delay time can be set from 0 to 24 hours in one-hour increments.
5. Press TIMER again to confirm the delay time. The TIMER light on the unit will be on.

Setting the Air Conditioner to Turn OFF:

1. Plug in the air conditioner and use the remote to power it ON.
2. Use the remote to set the desired mode, temperature, fan speed, etc.
3. Press TIMER on the remote and use the UP, DOWN buttons to set the desired delay time until the air conditioner turns OFF. The delay time can be set from 0 to 24 hours in one-hour increments.

4. Press TIMER again to confirm the delay time. The TIMER light on the unit will be on.

To cancel TIMER :

Press the TIMER button again. Once a "beep" is heard and the indicator disappears, the TIMER mode has been canceled.

NOTE: The TIMER function can only be set by the remote control.

SWING

Press SWING once to change the vertical airflow direction. Press again to hold the louver in a desired position.



NOTE: Swing function is not available on this models.

Normal Sounds

When your air conditioner is operating normally, you may hear sounds such as:

- Air movement from the fan.
- Clicks from the thermostat cycling.
- Vibration or noise due to poor wall or window construction.
- A high-pitched hum or pulsating noise caused by the high-efficiency compressor cycling on and off.

PORTABLE AIR CONDITIONER CARE

Draining the Air Conditioner

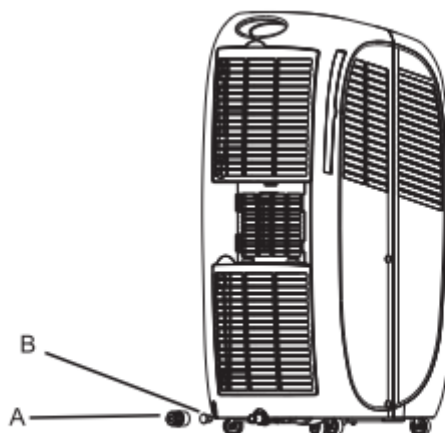

A. Primary drain cover B. Primary drain plug

WARNING! Excessive Weight Hazard: Use two or more people to move and install the air conditioner. Failure to do so can result in back or other injury.

1. Unplug the air conditioner or disconnect power.
2. Move the air conditioner to a drain location or outside.

NOTE: To avoid leaking water from the unit, move the air conditioner slowly and keep it level.

3. Remove the primary drain cover and plug.
4. Drain water completely through the drain hole.

NOTE: If the air conditioner will be stored after use, see "Storing After Use".

5. Reinstall the drain plug to the primary drain hole.
6. Reinstall the primary drain cover to the drain hole.
7. Reposition the air conditioner.
8. Plug in the air conditioner or reconnect power.

Cleaning the Outside

1. Press ON/OFF to turn off the air conditioner.
2. Unplug the air conditioner or disconnect power.
3. Remove the air filter and clean separately. See "cleaning the Air Filter".
4. Wipe the outside of the air conditioner with a soft, damp cloth.
5. Plug in the air conditioner or reconnect power.
6. Press ON/OFF to start the air conditioner.

Cleaning the Air Filter

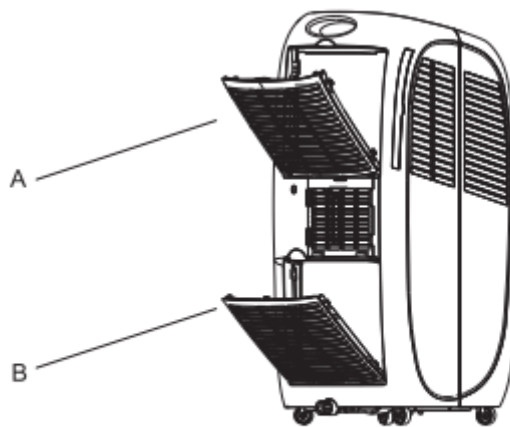

A. Evaporator air intake filter panel door
B. Condenser air intake filter panel door

1. Press ON/OFF to turn off the air conditioner.
2. Open the filter panel door on the back of the air conditioner and remove.
3. Remove the tapping screw from the condenser air intake filter panel door and remove.
4. Use a vacuum cleaner to clean the filter. If the filter is very dirty, wash the filter in warm water with a mild detergent. **NOTE:** Do not wash the filter in the dishwasher or use any chemical cleaners.
5. Air dry the filter completely before replacing to ensure maximum efficiency.
6. Reattach the air filter to the filter panel door.
7. Reinstall the filter panel door and tapping screw.
8. Press ON/OFF to start the air conditioner.

Storing After Use

If the air conditioner will not be used for an extended period of time:

1. Drain the water completely. See "draining the Air Conditioner".
2. Run the air conditioner set to Fan Only for approximately 12 hours to dry the air conditioner.
3. Unplug the air conditioner.
4. Remove the flexible exhaust hose and store with the air conditioner in a clean, dry area. See " installation Instructions ".
5. Remove the window kit and store with the air conditioner in a clean, dry area. See " Installation Instructions ".
6. Remove the filter and clean. See Cleaning the Air Filter.
7. Clean the outside of the air conditioner. See "Cleaning the Outside ".
8. Reinstall the filter.
9. Remove the batteries and store the remote control with the air conditioner in a clean, dry area.

Before using the air conditioner again:

1. Make sure the filter and drain cap are in place.
2. Check the power cord to make sure it is in good condition, with no cracks or damage.
3. Place new batteries in the remote.
4. Install the air conditioner. See "Installation Instructions".

TROUBLESHOOTING

Air conditioner will not operate

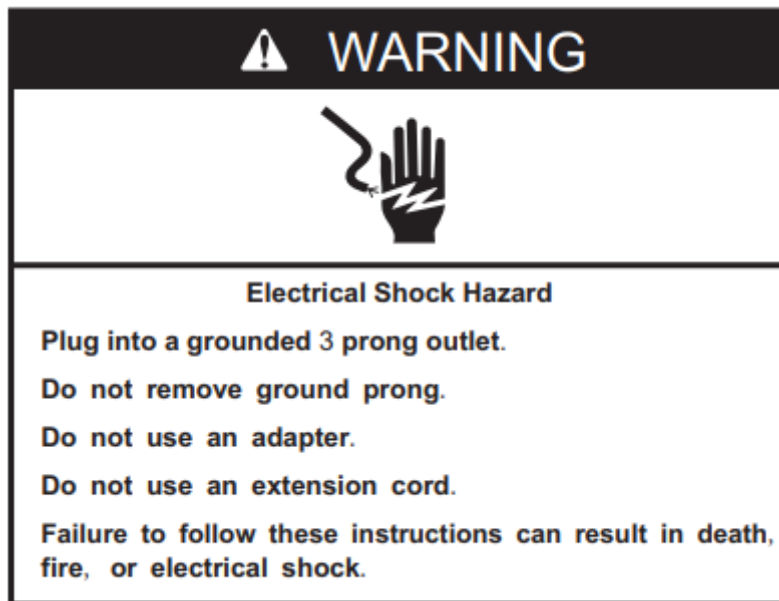

- **The power supply cord is unplugged.**

Plug into a grounded 3 prong outlet. See "electrical Requirements."

- **Time-delay fuse or circuit breaker of the wrong capacity is being used.**

Replace with a time-delay fuse or circuit breaker of the correct capacity. See "electrical Requirements".

- **The power supply cord has tripped (Reset button has popped out).**

Press and release RESET (listen for click; Reset button will latch and remain in) to resume operation.

- **A household fuse has blown, or a circuit breaker has tripped.**

Replace the fuse, or reset the circuit breaker. See "Electrical Requirements".

- **The On/Off button has not been pressed.**

Press ON/OFF.

- **The local power has failed.**

Wait for power to be restored.

Air conditioner blows fuses or trips circuit breakers

- **Too many appliances are being used on the same circuit.**

Unplug or relocate appliances that share the same circuit.

- **You are trying to restart the air conditioner too soon after turning off air conditioner.**

Wait at least 3 minutes after turning off air conditioner before trying to restart the air conditioner.

Air conditioner power supply cord trips (Reset button pops out)

- **Disturbances in your electrical current can trip (Reset button will pop out) the power supply cord.**

Press and release RESET (listen for click; Reset button will latch and remain in) to resume operation.

- **Electrical overloading, overheating, cord pinching or aging can trip (Reset button will pop out) the power supply cord.**

After correcting the problem, press and release RESET (listen for click; Reset button will latch and remain in) to resume operation. If the power cord fails to reset, contact a service technician.

NOTE: A damaged power supply cord must be replaced with a new power supply cord obtained from the product manufacturer and must not be repaired.

Air conditioner seems to run too much

- **Is there a door or window open?**

Keep doors and windows closed.

- **The current air conditioner replaced an older model.**

The use of more efficient components may cause the air conditioner to run longer than an older model, but the total energy consumption will be less. Newer air conditioners do not emit the "blast" of cold air you may be accustomed to from older units, but this is not an indication of lesser cooling capacity or efficiency. Refer to the efficiency rating (EER) and capacity rating (in Btu/h) marked on the air conditioner.

- **The air conditioner is in a heavily occupied room, or heat-producing appliances are in use in the room.**

Use exhaust vent fans while cooking or bathing and try not to use heat-producing appliances during the hottest part of the day. Portable air conditioners are designed as supplemental cooling to local areas within a room. A higher capacity air conditioner may be required, depending on the size of the room being cooled.

Air conditioner runs for a short time only, but room is not cool

- **Set temperature is close to room temperature.**

Lower set temperature. See "portable Air Conditioner Use".

Display error code

- **If the unit displays error code E5, the water container is full.**

Drain the water, see "Draining the air conditioner". After draining, the unit can be operated again.

- **If the unit display error code E1/E2/E3/E4/E6/E7/EA**

please contact customer service.

Air conditioner runs, but does not cool

- **The filter is dirty or obstructed by debris.**

Clean the filter.

- **Air outlet is blocked.**

Clear air outlet.

- **Set temperature is too high.**

Lower set temperature.

Air conditioner cycles on and off too much

- **The air conditioner is not properly sized for your room.**

Check the cooling capabilities of your portable air conditioner. Portable air conditioners are designed as supplemental cooling to local areas within a room.

- **The filter is dirty or obstructed by debris.**

Clean the filter.

- **There is excessive heat or moisture, open container cooking, showers, etc. in the room.**

Use a fan to exhaust heat or moisture from the room.

Try not to use heat-producing appliances during the hottest part of the day.

- **The louvers are blocked.**

Install the air conditioner in a location where the louvers are free from curtains, blinds, furniture, etc.

Warning

This content is compiled from multiple sources and is provided for reference purposes only. It may not be complete or fully applicable to all situations. If you are unable to resolve your issue, please contact the product manufacturer or an authorized service provider for official support.

