

Air Conditioner Features & Operating Instructions

Air Conditioner Features

ELECTRONIC CONTROL

Before you begin, thoroughly familiarize yourself with the control panel and remote as shown below and all its functions, then follow the symbol for the functions you desire. The unit can be controlled by the touch pad alone or with the remote.

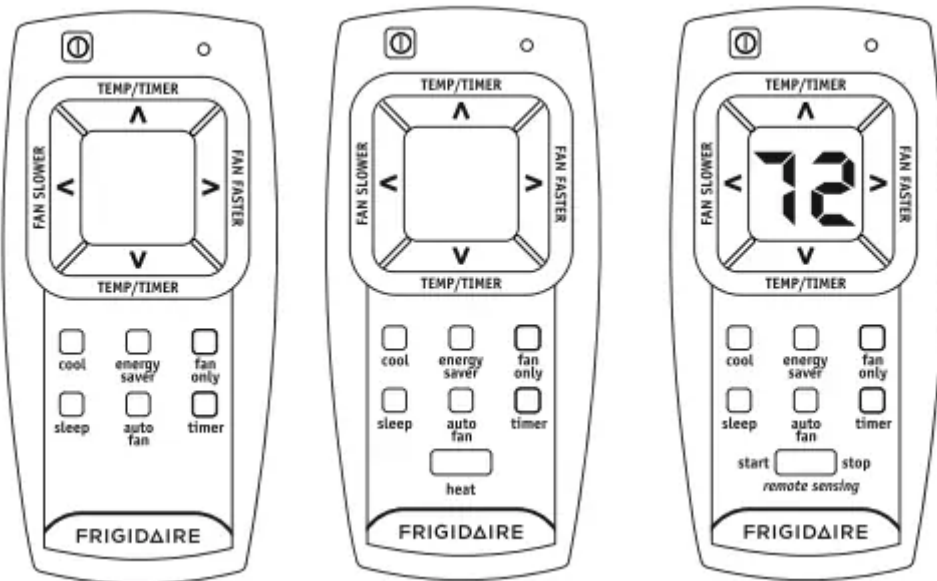
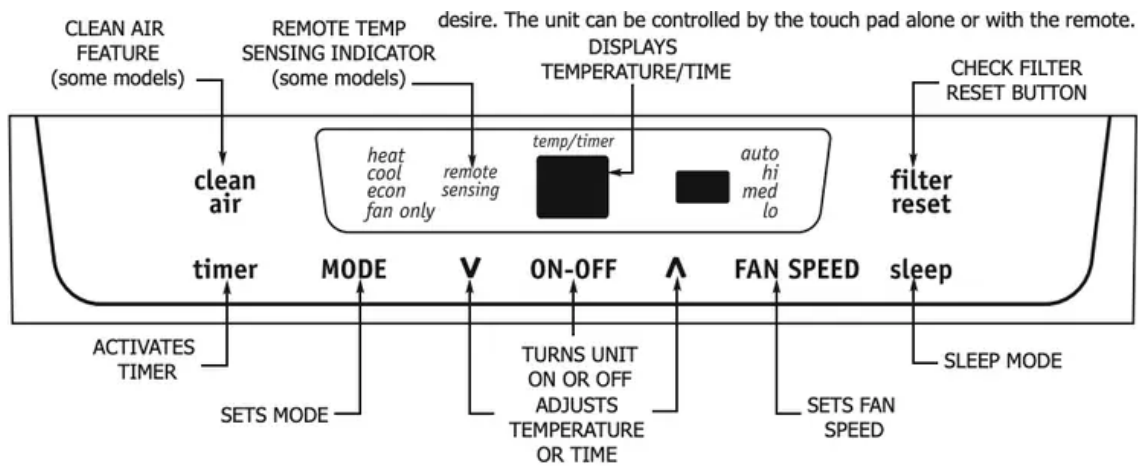

STANDARD REMOTE. FOR HEAT MODELS. w/DISPLAY & REMOTE SENSING BUTTON

Battery Size: AAA

Warning: Do not mix old and new batteries. Do not mix alkaline, standard (carbon-zinc), or rechargeable (nickelcadmium) batteries.



Operating Instructions



NOTE

The following instructions represent the Touch Pad, the same instructions can be used for the Remote Control.

TO TURN UNIT ON:

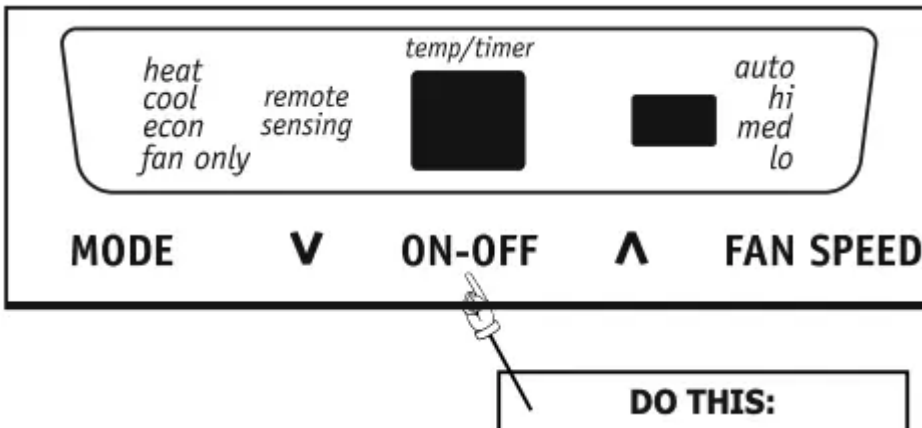

PRESS ON/OFF BUTTON

YOU WILL SEE:

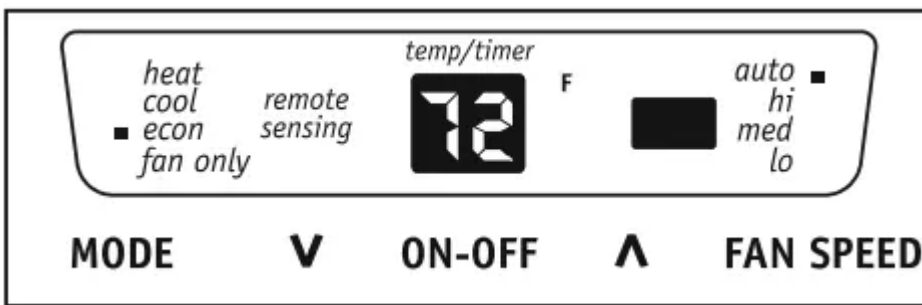

Note: The unit will run in energy saver(econ) mode when used for the first time. In this mode, the fan will continue to run for 1 minute after the compressor shuts off. The fan then cycles on for 20 seconds at 10 minute intervals until the room temperature is above the set temperature, at which time the compressor turns back on.

TO CHANGE TEMPERATURE SETTING:

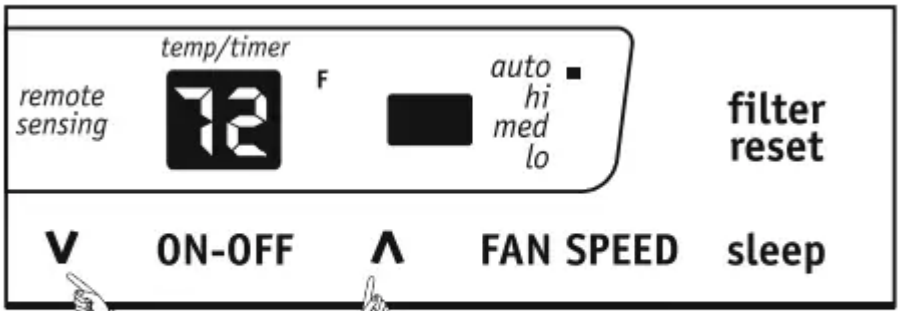

DO THIS:

PRESS **^** TO RAISE

PRESS **V** TO LOWER

YOU WILL SEE:

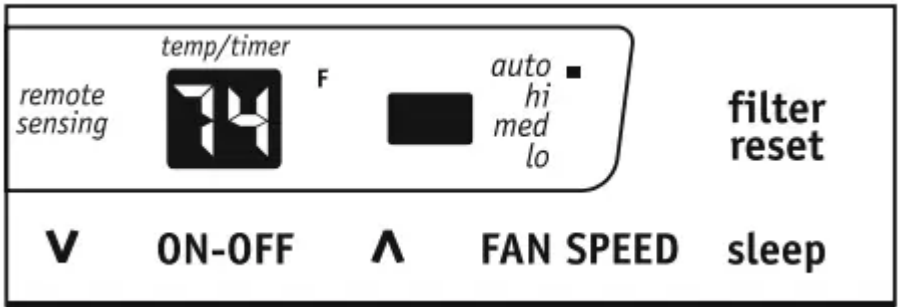

Note: Tap or hold either up (**^**) or down (**V**) button until the desired temperature is seen on the display. This temperature will be automatically maintained anywhere between 60 °F (16 °C) and 90 °F (32 °C) . If you want the display to read the actual room temperature. See "To Operate on Fan Only" section on Page 7.

TO ADJUST FAN SPEEDS:

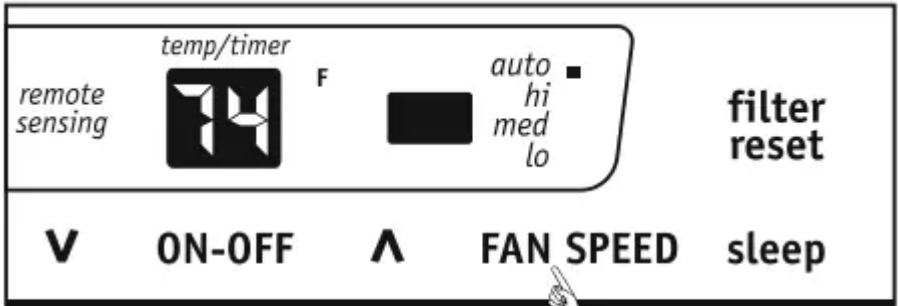

DO THIS:

PRESS TO SELECT



YOU WILL SEE:

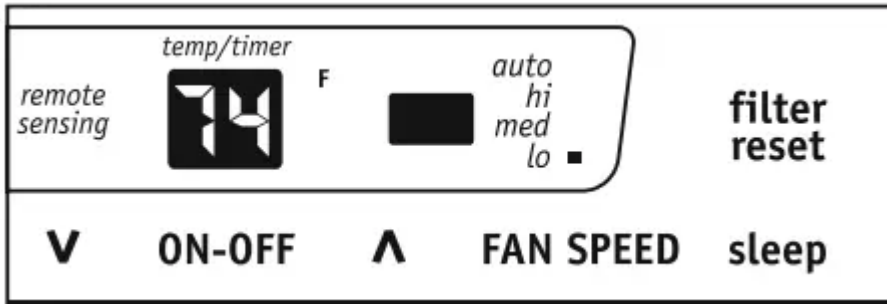

TO USE AUTO FAN FEATURE:

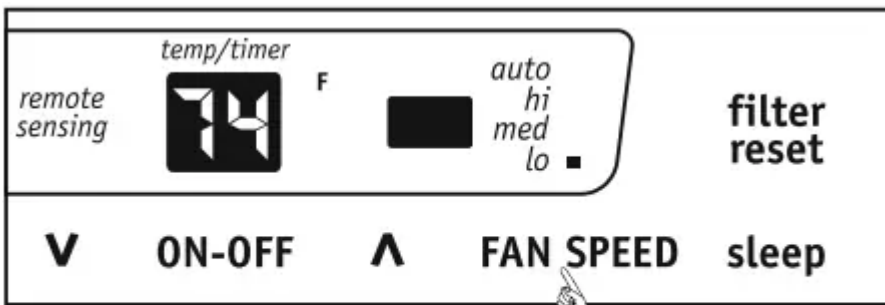

DO THIS:

PRESS FAN BUTTON, CHOOSE AUTO

YOU WILL SEE:

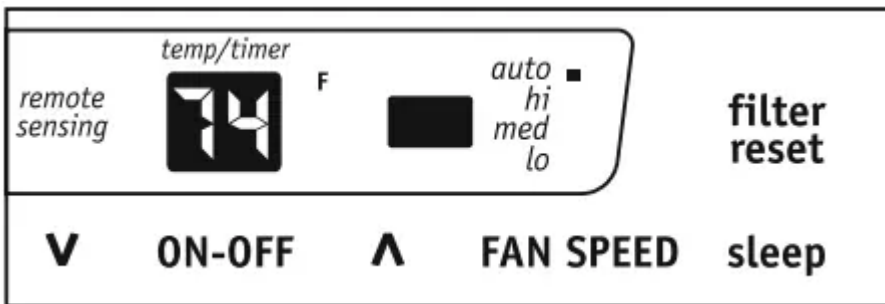

Note: Fan starts at High Speed and adjusts to a slower speeds the room temperature dictates. For example, if the room doesn't get too warm, it will stay at the slowest speed. If the room temperature rises quickly, such as a door being opened, it will automatically go to the highest speed. The fan speeds will re-adjust back to the slowest speed as the room returns to the original set temperature. Press either the fan slower or fan faster button to adjust the fan speed manually.

TO OPERATE ON FAN ONLY:

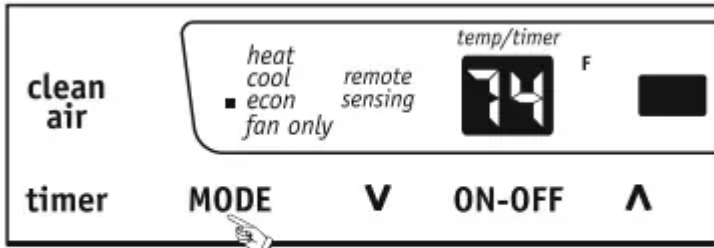

DO THIS:

PRESS MODE BUTTON
CHOOSE FAN ONLY

YOU WILL SEE:

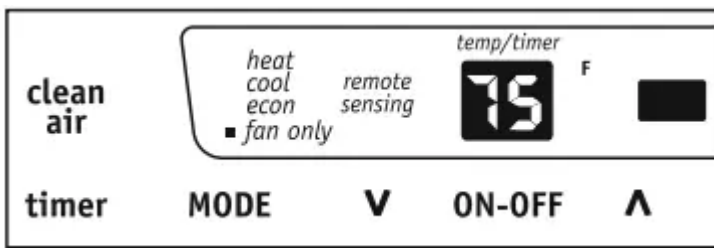

Note: Use this function only when cooling is not desired, such as for room air circulation or to exhaust stale air on some models. (Remember to open the vent during this function, but keep it closed during cooling for maximum cooling efficiency.) You can choose any fan speed you prefer. (Except “Auto Fan”). During this function, the display will show the actual room temperature, not the set temperature as in the cooling mode.

COOL FEATURE:

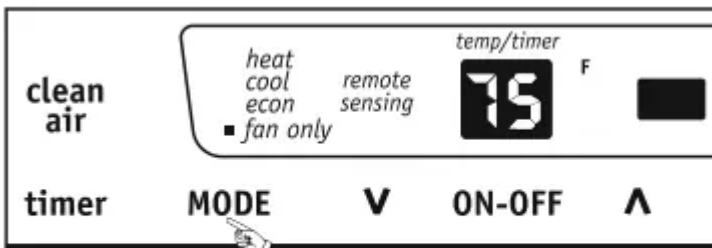

DO THIS:

PRESS MODE BUTTON
CHOOSE COOL

YOU WILL SEE:



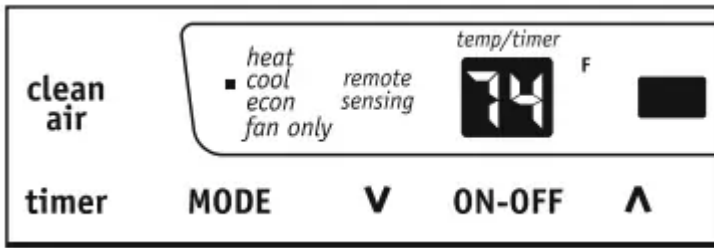

Note: In this mode, the fan remains on all the time with the compressor cycling on and off when room temperature is reached.

SLEEP FEATURE:

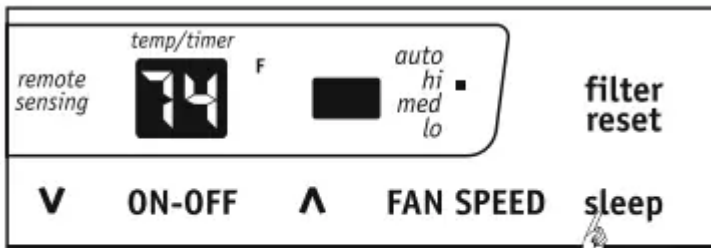

DO THIS:

PRESS SLEEP BUTTON

YOU WILL SEE:

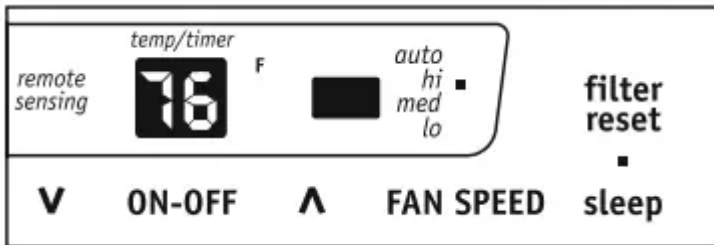

Note: In this mode the selected temperature will increase by 2 °F 30 minutes after the mode is selected. The temperature will then increase by another 2 °F after an additional 30 minutes. This new temperature will be maintained for 7 hours before it returns to the originally selected temperature. This ends the "Sleep" mode and the unit will continue to operate as originally programmed. The "Sleep" mode program can be cancelled at any time during operation by again pressing the "Sleep" button.

TIMER: DELAY STOP / START FEATURE



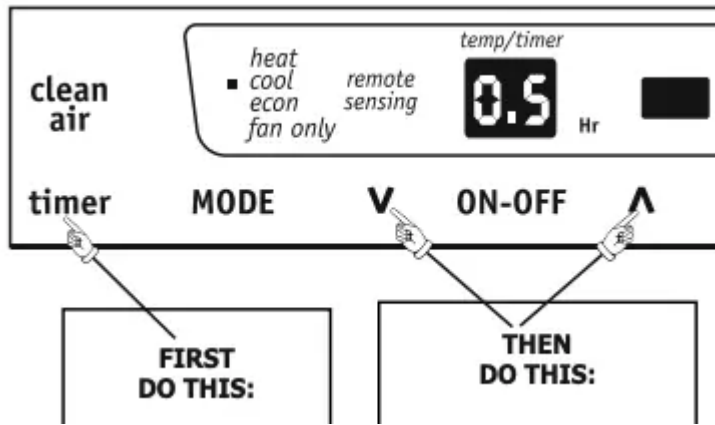

PRESS TIMER BUTTON PRESS UP/DOWN BUTTONS

YOU WILL SEE HOW MUCH TIME IS CHOSEN:

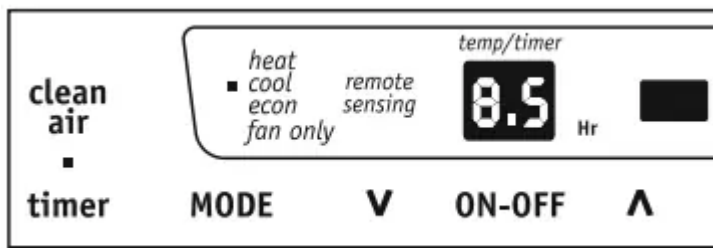

Note: For Delay Stop, the unit must be in the On position.

Note: For Delay Start, the unit must be in the Off position. First, Press TIMER button, then adjust timer setting, tap or hold the UP arrow (\wedge) or the DOWN arrow (\vee) to change delay timer at 0.5 hour increments, up to 10 hours, then at 1 hour increments up to 24 hours. The control will count down the time remaining until start (8, 7.5, 7, etc.). The Delay Start Operation automatically selects cooling with maximum Fan speed (if Cool, Energy Saver, or Fan Only was the last mode selected) . The temperature maintained will be the same as previously set. To change the set temperature, press "COOL" then Up or Down arrows until the desired temperature is indicated on the display. After 5 seconds, the control will automatically change the display back to the hours remaining until the unit will start/stop. Pressing the unit On/Off button at any time will cancel the Delay Start/Stop function. The Delay Start/Stop Feature will work until the unit either starts or stops. Once that happens the above steps have to be repeated again.

CHECK FILTER FEATURE, YOU WILL SEE:

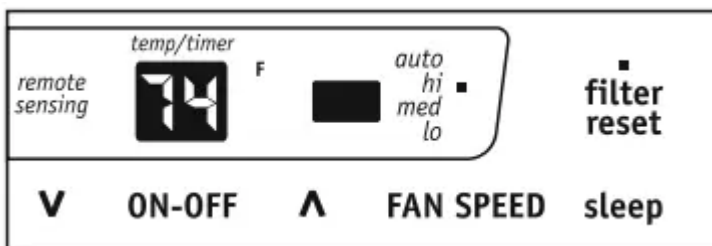

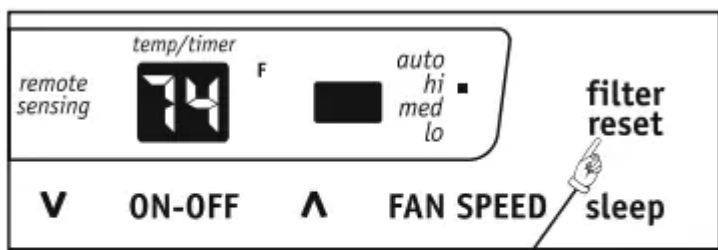

DO THIS:

PRESS FILTER RESET BUTTON

Note: This feature is a reminder to clean the Air Filter (See Care and Cleaning) for more efficient operation. The LED (light) will illuminate after 250 hours of operation. To reset after cleaning the filter, press the "Filter Reset" button and the light will go off.

CLEAN AIR FEATURE(on some models):

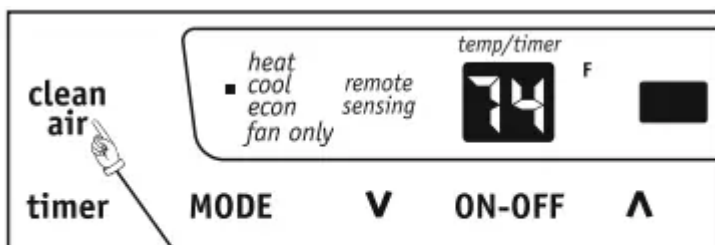

DO THIS:

PRESS CLEAN AIR BUTTON

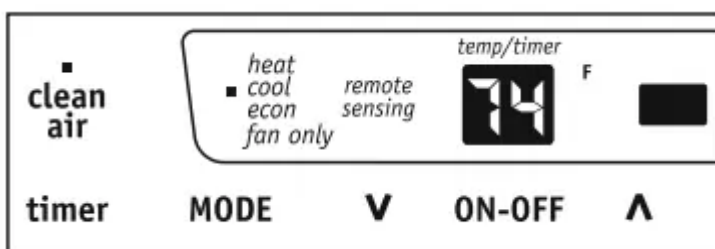

Note: When this feature is "ON", the electronic air purifier is energized to remove pollen and impurities from the air. To cancel this feature, press the Clean Air button (the LIGHT will turn off).
 Note: This feature can be activated on the unit touch pad ONLY.

REMOTE SENSING FEATURE (on some models) :



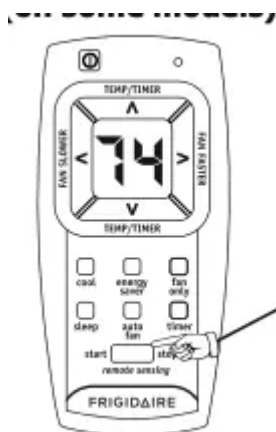

DO THIS: PRESS REMOTE SENSING START BUTTON

LIGHT pulsing (On & Off intermittently).

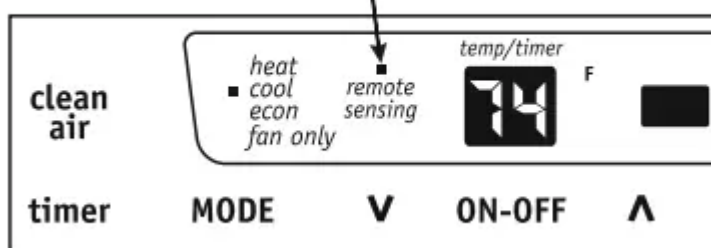

NOTE: Unit display shows the set temperature



NOTE: Remote display is actual temperature at remote control only

Note: This feature can be activated from the remote control ONLY, the unit must be in a cooling mode. To activate the remote sensing feature, point the remote control towards the unit and press the remote sensing Start button. Next, use the “ ^ v ” buttons to set the desired temperature at the remote. (Note that the set temperature will only be displayed on the unit itself). The LIGHT on the unit control will pulse to indicate it received the signal. The LIGHT on the remote control will pulse each time it sends a signal. It will periodically send this signal until the feature is deactivated by pressing the remote sensing Stop button. If the unit does not receive the remote sensing signal during any 3 minute interval, the unit will beep to indicate the remote sensing mode has ended. The display on the remote control indicates the temperature at the remote ONLY.



NOTE: The Remote Sensing function is terminated either by using the Remote Sensing Stop button or the main ON/OFF button on the unit.

HEATING FEATURE(on some models):

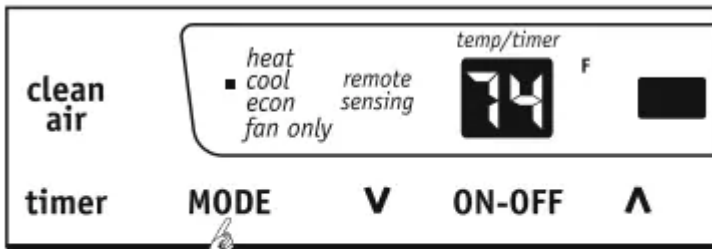

DO THIS:

PRESS MODE BUTTON, CHOOSE HEAT

YOU WILL SEE:

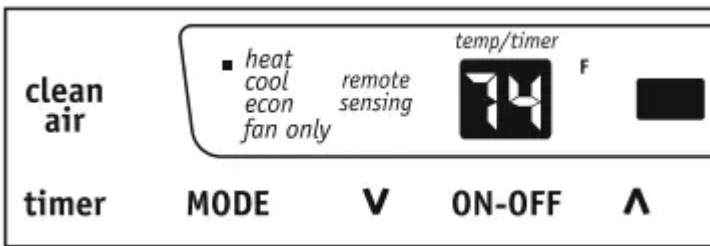

Note: This feature can be used with any combination of FAN Speeds (Low speed only on 115V models), Timer, or Sleep Modes. When in the "Heat" mode, the fan will run continuously while heat is needed. The temperature will automatically be maintained anywhere between 55 °F(13 °C) and 80 °F(27 °C) (The upper limit of temperature could reach 86°F(30 °C) on some of the 115V models.). When the room set temperature is satisfied, the fan will cycle off and on to circulate and sample the room air.

FAULT CODES:

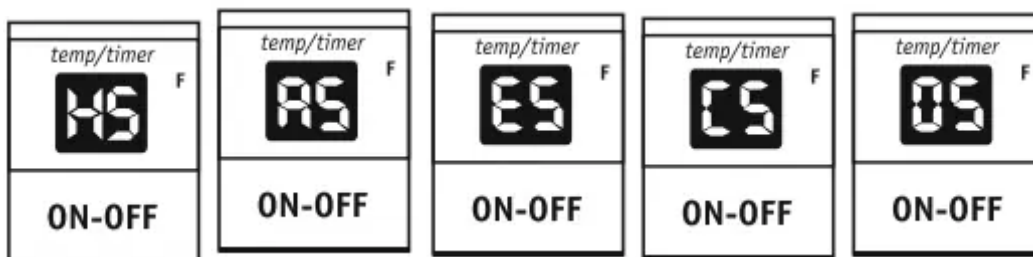

If the display reads "HS", "AS", "ES", "CS" or "OS", a sensor has failed. Contact your Authorized Frigidaire Service Center.

TO CHANGE TEMPERATURE DISPLAY:



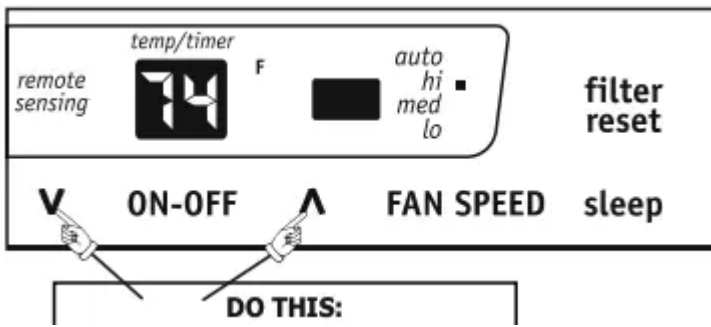

PRESS AND HOLD THE
UP/DOWN BUTTONS
TOGETHER FOR 3 SECONDS

YOU WILL SEE:

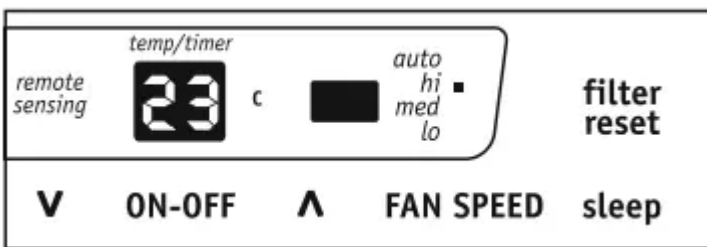

Note: The control is capable of displaying temperature in degrees Fahrenheit or degrees Celsius.

TO TURN UNIT OFF:

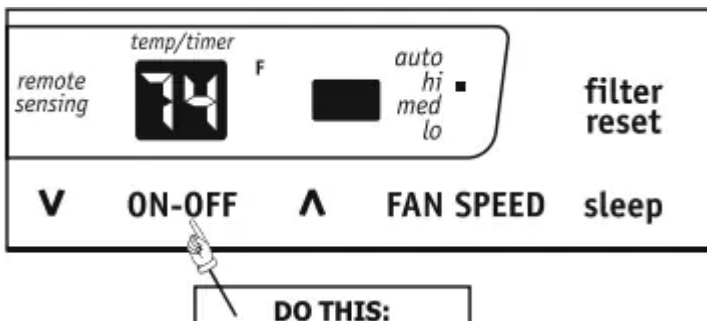

PRESS ON/OFF BUTTON

YOU WILL SEE:

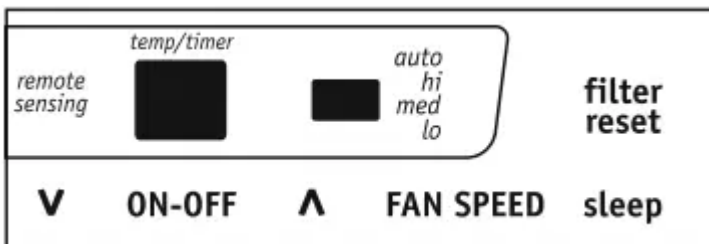



Note: If the unit is turned off in heat mode (if applicable) or fan only mode, it will return to the same setting when it is turned on again. When the unit is turned off in cool or energy saver(econ) mode,

it will run in energy saver(econ) mode when it is turned on again, but the setting of temperature and fan speed will remain.

ADDITIONAL THINGS YOU SHOULD KNOW

Now that you have mastered the operating procedure, here are more features in your control that you should become familiar with

-  The "Cool" circuit has an automatic 3 minute time delayed start if the unit is turned off and on quickly. This prevents overheating of the compressor and possible

circuit breaker tripping. The fan will continue to run during this time. 

- There is a 2-Second delay for the compressor shutting down when selecting FAN ONLY/ HEAT. This is to cover the possibility of having to roll through to select another mode.
- The control will maintain the set temperature within 2 degrees Fahrenheit, between 60F and 90F degrees in cool mode, 55F and 80F degrees in heat mode(the upper limit of temperature could reach 86F degrees on some of the 115V models).
- After a power outage, the unit will memorize the last setting and return the unit to the same setting once power is restored.

Fresh Air Vent Control (on some models)

The Fresh Air Vent allows the air conditioner to:

1. Recirculate inside air - Vent Closed (see Fig. 1)

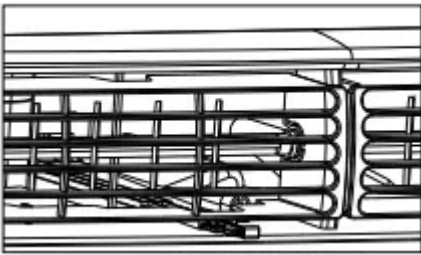

Figure 1 (VENT CLOSED)

2. Draw fresh air into the room - Fresh Air (see Fig. 2)

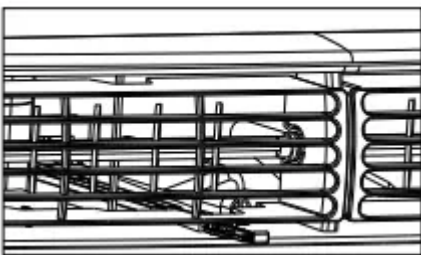

Figure 2 (FRESH AIR)

3. Exchange air from the room - Vent Open (see Fig. 3)

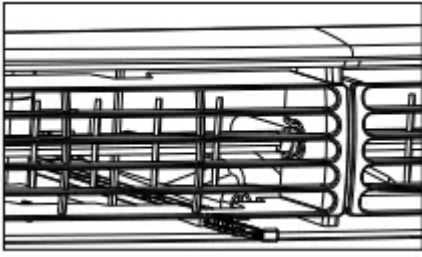
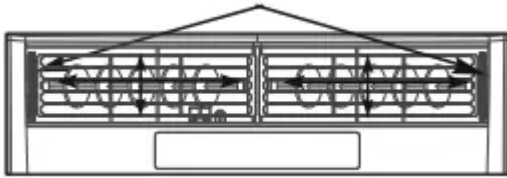

Figure 3 (VENT OPEN)

AUGER WHEELS



(8-WAY)

Air Directional Louvers

Air directional louvers control air flow direction. Your air conditioner has the louver type described below. Auger Type The louvers will allow you to direct the air flow Up or Down and Left or Right throughout the room as needed.

Rotate the Auger

Wheels until the desired Left/Right direction is obtained. Pivot horizontal louvers until the desired Up/Down direction is obtained.

Care and Cleaning

Clean your air conditioner occasionally to keep it looking new. Be sure to unplug the unit before cleaning to prevent shock or fire hazards.

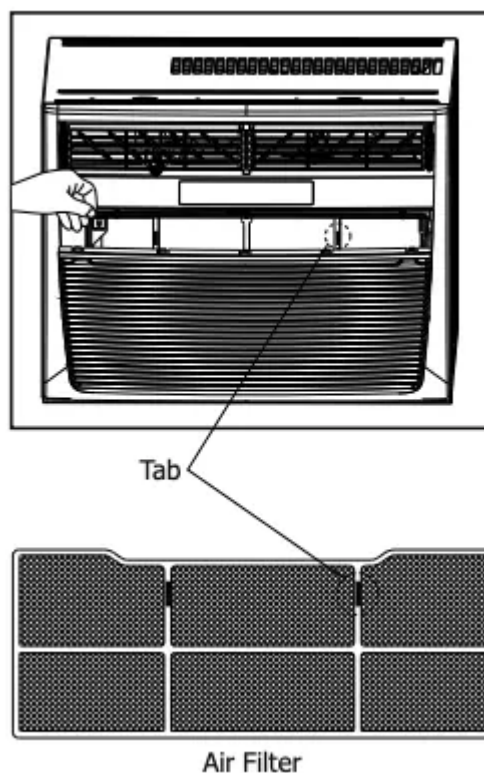

Air Filter Cleaning

The air filter should be checked at least once a month to see if cleaning is necessary. Trapped particles in the filter can build up and cause an accumulation of frost on the cooling coils.

- Push the vent handle to the Vent Closed position (where applicable).
- Open the front panel.
- Grasp the filter by the center and pull up and out.
- Wash the filter using liquid dishwashing detergent and warm water. Rinse filter thoroughly. Gently shake excess water from the filter. Be sure filter is thoroughly dry before replacing
- Or instead of washing, you may vacuum the filter clean.

NOTE: When replacing the air filter after cleaning, make sure the tabs on the air filter are on the upper part of filter, and placed outward as shown in the drawing on the left side.

Cabinet Cleaning

- Be sure to unplug the air conditioner to prevent shock or fire hazard. The cabinet and front may be dusted with an oil-free cloth or washed with a cloth dampened in a solution of warm water and mild liquid dishwashing detergent. Rinse thoroughly and wipe dry.
- Never use harsh cleaners, wax or polish on the cabinet front.
- Be sure to wring excess water from the cloth before wiping around the controls. Excess water in or around the controls may cause damage to the air conditioner.
- Plug in air conditioner.

Winter Storage

If you plan to store the air conditioner during the winter, remove it carefully from the window according to the installation instructions. Cover it with plastic or return it to the original carton.

Energy Saving Ideas



- Do not block air flow inside with blinds, curtains or furniture; or outside with shrubs, enclosures, or other buildings.
- The capacity of the room air conditioner must fit the room size for efficient and satisfactory operation.
- Install the room air conditioner on the shady side of your home. A window that faces north is best because it is shaded most of the day.
- Close the fireplace damper, floor and wall registers so cool air does not escape up the chimney and into the duct work.
- Keep blinds and drapes in other windows closed during the sunniest part of the day.
- Clean the air filter as recommended in the section "Care and Cleaning".
- Proper insulation and weather stripping in your home will help keep warm air out and cool air in.
- External house shading with trees, plants or awnings will help reduce the air conditioner's work load.
- Operate heat producing appliances such as ranges, washers, dryers and dishwashers during the coolest part of the day

Before You Call

Before calling for service, review this list. It may save you time and expense. This list includes common occurrences that are not the result of defective workmanship or materials in this appliance.

Air conditioner will not operate.

- Wall plug disconnected. Push plug firmly into wall outlet.
- Plug Current Device Tripped. Press the RESET button.
- House fuse blown or circuit breaker tripped. Replace fuse with time delay type or reset circuit breaker.
- Control is OFF. Turn Control ON and set to desired setting.

Air from unit does not feel cold enough.

- Room temperature below 60°F (16°C). Cooling may not occur until room temperature rises above 60°F (16°C).
- Temperature sensing element touching cold coil, located behind air filter. Straighten away from coil.
- Compressor shut-off by changing modes. Wait approximately 3 minutes and listen for compressor to restart when set in the COOL mode.
- Reset to a lower temperature.

Air conditioner cooling, but room is too warm - ice forming on cooling coil behind decorative front

- Outdoor temperature below 60 F (16 C). To defrost the coil, set FAN ONLY mode.
- Air filter may be dirty. Clean filter. Refer to Care and Cleaning section. To defrost, set to FAN ONLY mode.
- Temperature is set too low for night-time cooling. To defrost the coil, set to FAN ONLY mode. Then, set temperature to a higher setting.

Air conditioner cooling, but room is too warm - NO ice forming on cooling coil behind decorative front.

- Dirty air filter - air restricted. Clean air filter. Refer to Care and Cleaning section.
- Temperature is set too high. Set temperature to a lower setting.
- Air directional louvers positioned improperly. Position louvers for better air distribution.
- Front of unit is blocked by drapes, blinds, furniture, etc. - restricts air distribution. Clear blockage in front of unit.
- Doors, windows, registers, etc. open - cool air escapes. Close doors, windows, registers, etc.

- Unit recently turned on in hot room. Allow additional time to remove “stored heat” from walls, ceiling, floor and furniture.

Air conditioner turns on and off rapidly.

- Dirty air filter - air restricted. Clean air filter.
- Outside temperature extremely hot. Set FAN speed to a faster setting to bring air through cooling coils more frequently.

Noise when unit is cooling

- Air movement sound. This is normal. If too loud, set to lower FAN setting.
- Window vibration - poor installation. Refer to installation instructions or check with installer.

Water dripping INSIDE when unit is cooling.

Improper installation. Tilt air conditioner slightly to the outside to allow water drainage. Refer to installation instructions or check with installer

Water dripping OUTSIDE when unit is cooling.

Unit removing large quantity of moisture from humid room. This is normal during excessively humid days.

Remote Sensing Deactivating Prematurely (some models).

- Remote control not located within range. Place remote control within 20 feet & 120° radius of the front of the unit .
- Remote control signal obstructed. Remove obstruction.

Room too cold.

- Set temperature too low. Increase set temperature.
- Remote Sensing activated (on some models) and remote control located in Hot Spot - Relocate remote control or deactivate remote sensing.

Warning

This content is compiled from multiple sources and is provided for reference purposes only. It may not be complete or fully applicable to all situations. If you are unable to resolve your issue, please contact the product manufacturer or an authorized service provider for official support.