

Getting Started

Connecting the AC adaptor

Base unit

1. Connect the AC adaptor plug to the unit until you hear a click.
2. Connect the AC adaptor to the power outlet.

Note:

- Use only the supplied Panasonic AC PNLV234.

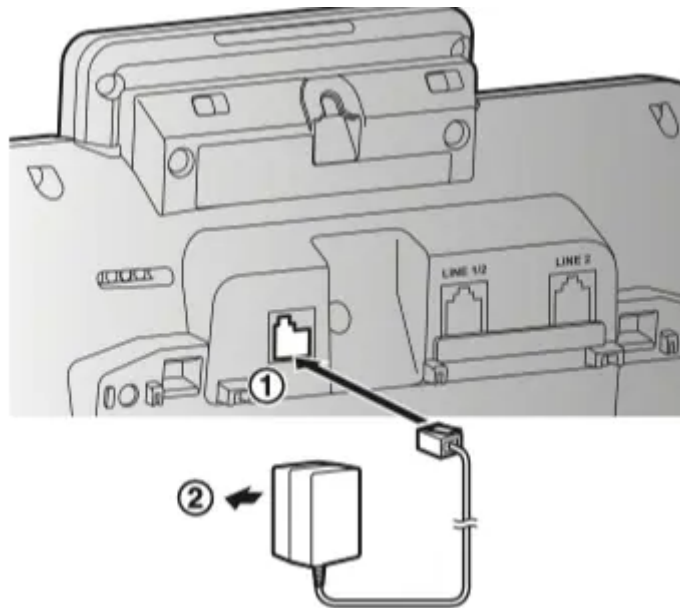

- Follow the directions on the display to set up the unit.

Charger

1. Connect the AC adaptor to the power outlet.

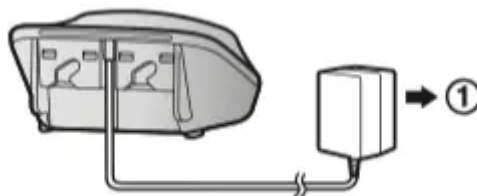

Connecting the telephone line cord

Refer to one of the following methods depending on your situation:

- To connect to a 2-line telephone jack: page 9

- To connect to 2 single-line telephone jacks: page 9
- If you use the unit as a single-line telephone only: page 9

Connect the telephone line cord until it clicks into the base unit and telephone line jack.

To connect to a 2-line telephone jack

1. Connect the “GREEN” plug telephone line cord (4-wire cord) (**A**) to the unit, then to the 2-line telephone jack (RJ14C) (**B**) until you hear a click.

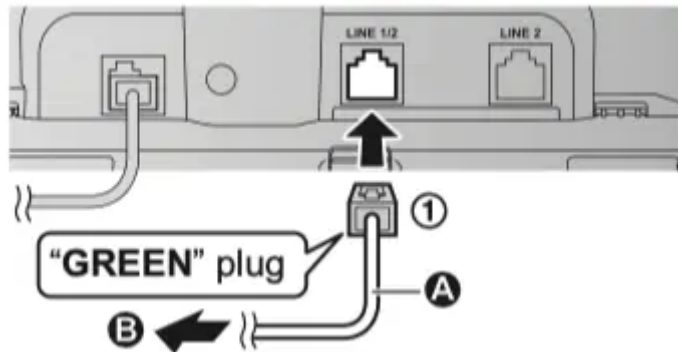

To connect to 2 single-line telephone jacks

1. For Line 1: Connect the “Transparent” plug telephone line cord (2-wire cord) (**A**) to the unit, then to the Line 1 single-line telephone jack (RJ11C) (**B**) until you hear a click.
2. For Line 2: Connect the “GREEN” plug telephone line cord (4-wire cord) (**C**) to the unit, then to the Line 2 single-line telephone jack (RJ11C) (**D**) until you hear a click

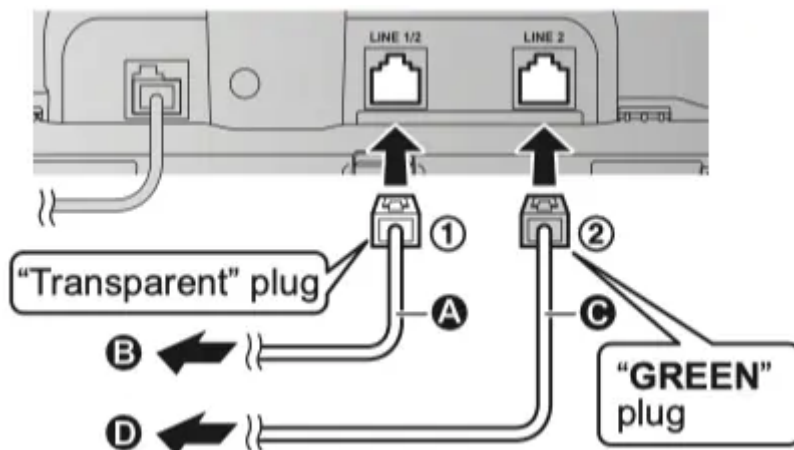

If you use the unit as a single-line telephone only

Be sure to connect the telephone line cord to LINE 1/2. Change the line selection mode from “Auto” to “Line1” (page 17).

1. Connect the “Transparent” plug telephone line cord (2-wire cord) (**A**) to the unit, then to the single-line telephone jack (RJ11C) (**B**) until you hear a click.

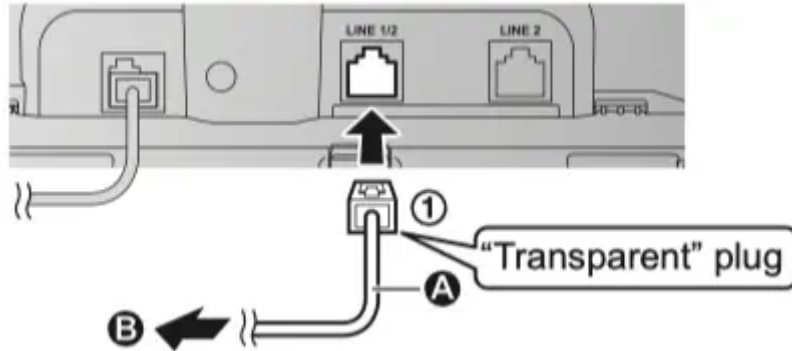

Note:

- “Check tel line2” is displayed on the unit. To erase it, see page 64.

If you subscribe to a DSL/ADSL service

Please attach a DSL/ADSL filter (contact your DSL/ ADSL provider) to the telephone line between the base unit and the telephone line jack in the event of the following:

- noise is heard during conversations.
- Caller ID features do not function properly.

To connect to a 2-line telephone jack

Example: DSL/ADSL line is line 2

1. Connect the “Transparent” plug telephone line cord (2-wire cord) (**A**) to the 2-line splitter (**C**) until you hear a click.
2. Connect the “GREEN” plug telephone line cord (4-wire cord) (**B**) to a DSL/ADSL filter (not supplied) (**D**), then to the 2-line splitter (**C**) until you hear a click.
3. Connect the 2-line splitter (**C**) to the 2-line telephone jack (RJ14C) (**E**) until you hear a click.



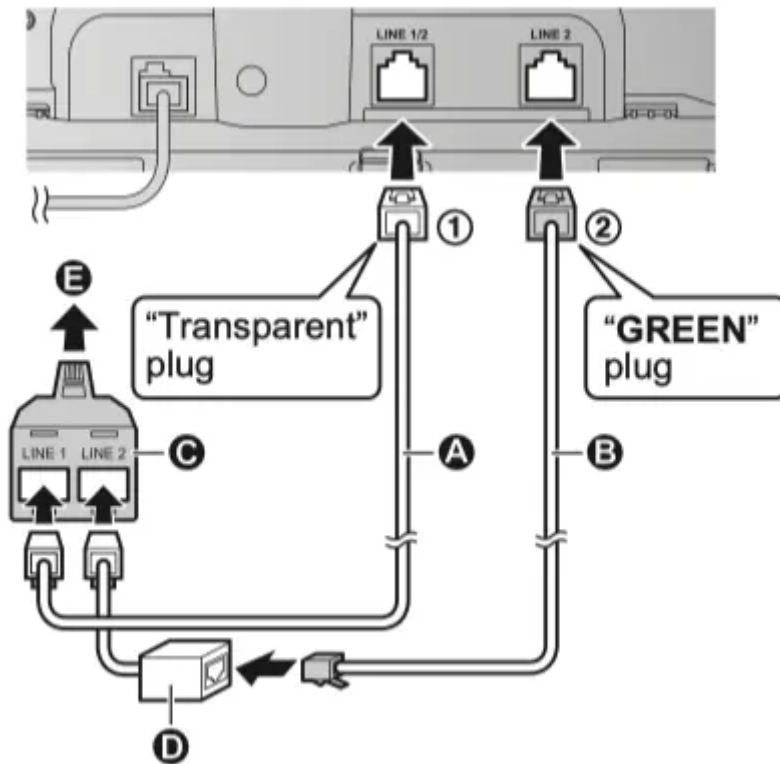

*DSL/ADSL filter (not supplied) is required if you have DSL/ADSL service.

To connect to 2 single-line telephone jacks

Example: DSL/ADSL line is line 2

1. Connect the "Transparent" plug telephone line cord (2-wire cord) (**A**) to the unit, then to the single-line telephone jack (RJ11C) (**B**) until you hear a click.
2. Connect the "GREEN" plug telephone line cord (4-wire cord) (**C**) to a DSL/ADSL filter (not supplied) (**D**), then to the single-line telephone jack (RJ11C) (**E**) until you hear a click.

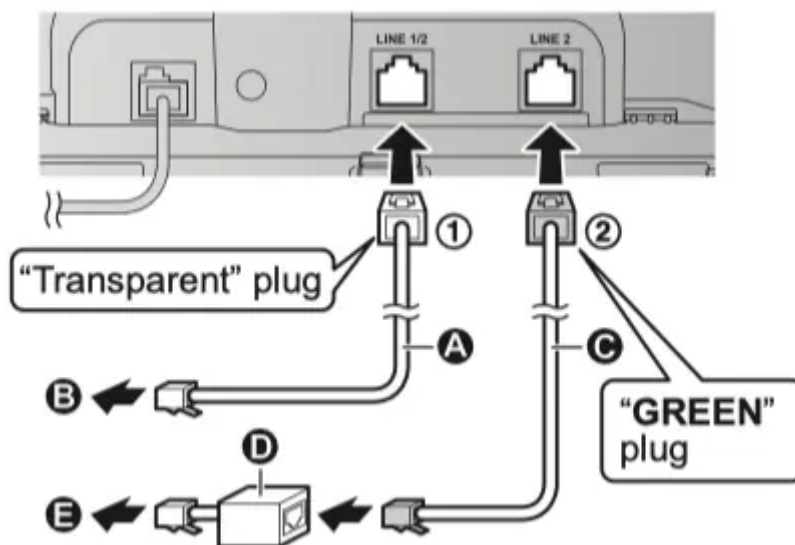

*DSL/ADSL filter (not supplied) is required if you have DSL/ADSL service.

Battery installation

- USE ONLY Ni-MH batteries AAA (R03) size (1).
- Do NOT use Alkaline/Manganese/Ni-Cd batteries.
- Confirm correct polarities (⊕, ⊖).

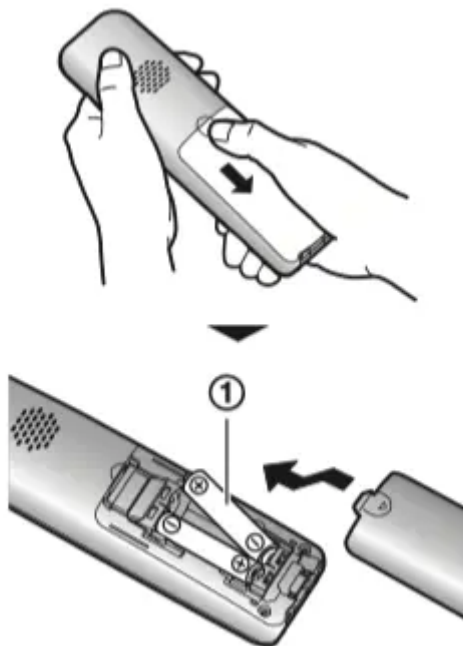

- Follow the directions on the display to set up the unit.

Battery charging

Charge for about 7 hours.

- Confirm “Charging” is displayed (1).
- When the batteries are fully charged, “Fully charged” is displayed.



Note when setting up

Note for connections

- The AC adaptor must remain connected at all times. (It is normal for the adaptor to feel warm during use.)
- The AC adaptor should be connected to a vertically oriented or floor-mounted AC outlet. Do not connect the AC adaptor to a horizontally oriented AC outlet that faces the floor, such as an AC outlet installed on a ceiling or under a table, as the weight of the adaptor may cause it to become disconnected.

Note for battery installation





Use the supplied rechargeable batteries. For replacement, we recommend using the Panasonic rechargeable batteries noted on page 4, 6.

Note for battery charging

- It is normal for the handset to feel warm during charging.
- Clean the charge contacts of the handset, base unit, and charger with a soft and dry cloth once a month. Before cleaning the unit, disconnect from power outlets and any telephone line cords. Clean more often if the unit is exposed to grease, dust, or high humidity.

Battery level

Icon	Battery level
	High

Icon	Battery level
	Medium
	Low
	Needs charging.
	Empty

Ni-MH battery performance (supplied batteries)

Operation	Operating time
In continuous use	15 hours max.* ¹
Not in use (standby)	7 days max.* ¹

*¹ If eco mode is on.

Note:

- Actual battery performance depends on usage and ambient environment.

Power back-up operation

When a power failure occurs, you can use the unit temporarily by inserting 2 standard AAA (R03) size batteries into the base unit. Both alkaline batteries and rechargeable batteries can be used for the base unit, but we recommend that you use the charged batteries (supplied) installed in your handset.

Battery installation

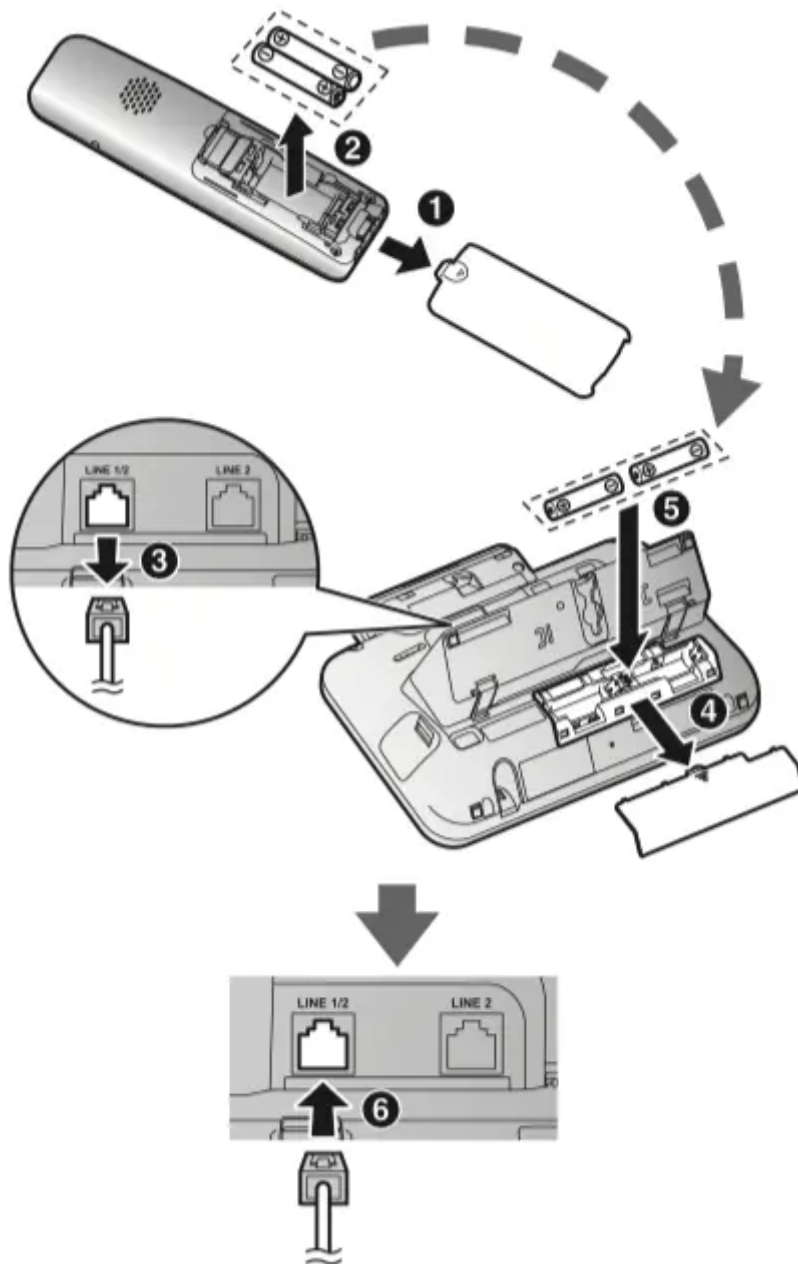

1. Open the handset cover (1), then remove the batteries (2).
2. Disconnect the telephone line cord(s) (3).



3. Open the battery cover (4).
 4. Install the batteries in the battery compartment (5).
 5. When finished, close the cover, then reconnect the telephone line cord(s) (6).
- When this feature is turned on,  is displayed.

Note:

- Do not insert the batteries into the base unit except during power failure. (The base unit may be damaged due to battery leakage.)
- The batteries for the base unit are not supplied.
- The speaker volume of the base unit is limited during a power failure (level 5 max.).

Battery caution

- The batteries should be used correctly, otherwise the unit may be damaged due to battery leakage.
- Do not mix old, new or different types of batteries.
- Do not charge, short-circuit, disassemble, or heat the batteries.
- Do not dispose of batteries in a fire.
- It is recommended that batteries are replaced annually.
- It is recommended that batteries are replaced after a power outage.
- Operating time may be shortened depending on usage conditions, ambient temperature, and battery quality.
- Remove all the batteries when replacing.
- Do not use Manganese batteries.
- Rechargeable batteries will not charge while they are in the base unit.
- If there is a connected device (for example, a modem) between the base unit and the telephone line jack, the power backup operation of the unit may not function, even if a backup battery is in the base unit.

Battery life

When the batteries are fully charged, operating time varies depending on usage.

Ni-MH batteries

Operation	Operating time
While in use (handset talking)	60 minutes
While not in use (standby)	70 minutes



Note:

- The operating time depends on the type of batteries.
- The battery cannot be charged even if the AC adaptor is connected.
- If  on the base unit flashes, the battery power is low. Install new batteries as soon as possible.

Intelligent eco mode

This feature automatically reduces handset power consumption by suppressing handset transmission power when the handset is close to the base unit.

- When this feature is activated, **ECO** is displayed. However, during a call, **ECO** is not displayed even though this feature is activated.
- Eco mode is turned off when the clarity booster is activated (page 24).

Controls

Handset

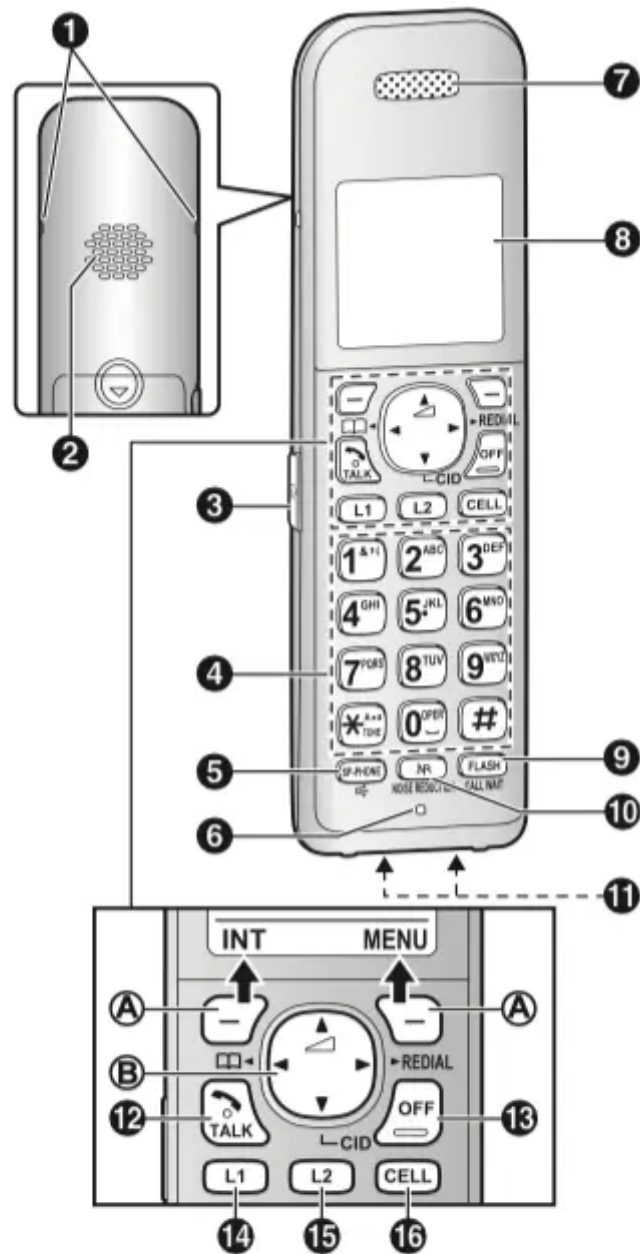

- 1** Belt clip hole
- 2** Speaker
- 3** Headset jack
- 4** Dial keypad (☒: TONE)
- 5** [☒] (SP-PHONE: Speakerphone)
- 6** Microphone
- 7** Receiver



- 8 Display
- 9 [FLASH] [CALL WAIT]
- 10 [NR][NOISE REDUCTION]
- 11 Charge contacts
- 12 [↩] (TALK)
- 13 [OFF]
- 14 [L1] (Line 1)
- 15 [L2] (Line 2)
- 16 [CELL]

Control type

A . Soft keys

By pressing a soft key, you can select the feature shown directly above it on the display.

B. Navigator key

- [▲], [▼], [◀], or [▶]: Scroll through various lists and items.
-  (Volume: [▲] or [▼]): Adjust the receiver or speaker volume while talking.
- [◀]  : View the phonebook entry.
- [▶] REDIAL: View the redial list.
- [▼] MCN CID (Caller ID): View the caller list.

Base unit

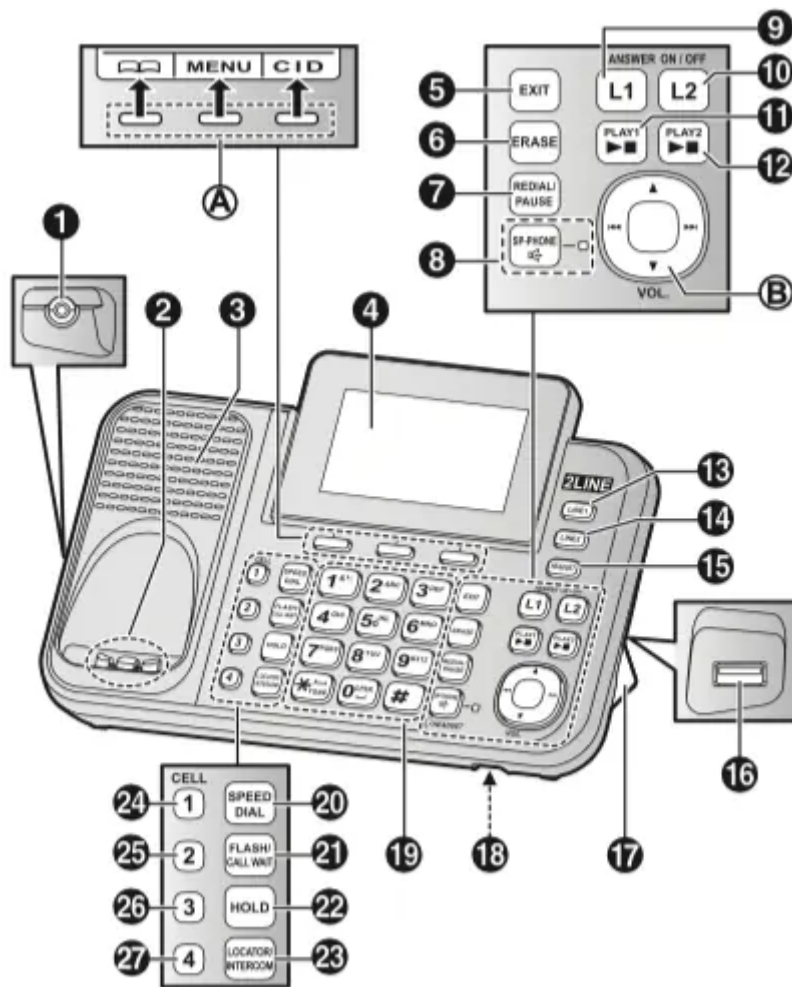

- 1** Headset jack
- 2** Charge contacts
- 3** Speaker
- 4** Display
 - The display can be moved back and forth to select the desired angle.

- 5 [EXIT]**
- 6 [ERASE]**
- 7 [REDIAL] [PAUSE]**
- 8 [📞] (SP-PHONE: Speakerphone)**
SP-PHONE indicator
Corded headset indicator
- 9 [L1] (Line 1: ANSWER ON/OFF)**
L1 ANSWER ON/OFF indicator
- 10 [L2] (Line 2: ANSWER ON/OFF)**
L2 ANSWER ON/OFF indicator
- 11 [▶■] (PLAY1) (Stop)**
Message indicator
- 12 [▶■] (PLAY2) (Stop)**
Message indicator
- 13 [LINE 1]**
LINE 1 indicator
- 14 [LINE 2]**
LINE 2 indicator
- 15 [HEADSET]**
Bluetooth HEADSET indicator
- 16 USB jack**
- 17 Desk stand/Wall mounting adaptor**
 - The adaptor is a removable attachment for desk stand or wall mounting use (page 62).
- 18 Microphone**
- 19 Dial keypad (☒): TONE)**
- 20 [SPEED DIAL]**
- 21 [FLASH] [CALL WAIT]**
- 22 [HOLD]**
- 23 [LOCATOR] [INTERCOM]**
 - You can locate a misplaced handset by pressing [LOCATOR].
- 24 [CELL 1]**
CELL 1 indicator
- 25 [CELL 2]**
CELL 2 indicator
- 26 [CELL 3]**
CELL 3 indicator
- 27 [CELL 4]**
CELL 4 indicator

Control type

A . Soft keys

By pressing a soft key, you can select the feature shown directly above it on the display.

B. Navigator key

- **[▲], [▼], [◀◀], or [▶▶]**: Scroll through various lists and items.
- VOL. (Volume: **[▲]** or **[▼]**): Adjust the speaker volume while talking.
- **[◀◀]/[▶▶]**: Repeat/skip messages during playback.

Charging the cellular phone by USB

By connecting a USB cable (not supplied) to the cellular phone and the base unit, you can charge a cellular phone. However, the cellular phone cannot exchange data with the base unit through a USB cable.

























Note:

- USB charging may not work properly depending on the cellular phone's specifications.

Display icons/Indicators

Handset display items

Item	Meaning
	Within base unit range
	Out of base unit range
	<p>The landline is in use.*1</p> <ul style="list-style-type: none"> ● When flashing: The call is put on hold. ● When flashing rapidly: An incoming call is now being received.
 	<ul style="list-style-type: none"> – A landline call is being done on that line. – The landline is selected for the setting.
	<p>A cellular line is in use.</p> <ul style="list-style-type: none"> ● When flashing: The cellular call is put on hold. ● When flashing rapidly: A cellular call is being received.
	Eco mode is on.*2 (page 13)

Item	Meaning
	A cellular phone is connected.* ³ Ready to make/receive cellular calls. ● When turned off: A cellular phone is not connected to the base unit. (page 20)
   	– A cellular call is being done on that line. – The cellular line is selected for the setting.
	Noise reduction is set. (page 24)
	Equalizer is set. (page 24)
	Speakerphone is on. (page 22)
	Ringer volume is off.* ⁴ (page 23, 39)
	Silent mode is on. (page 44)
	Call sharing mode is off. (page 42)
	Alarm is on. (page 43)
	Handset number
	Battery level
	Blocked call (page 44)
In use :	Someone is using the corresponding line.





*1 A cellular phone is connected. Ready to make/receive cellular calls. Corresponding landline number(s) is(are) indicated next to the item.



*2 During a call, the item is not displayed even though the feature is activated.

*3 Corresponding cellular line(s) is(are) indicated next to the item.

*4 Corresponding lines (1, 2: landline, C: cellular line) are indicated next to the item. If all lines are turned off, no line is indicated.

Base unit display items

Item	Meaning
	Silent mode is on. (page 44)
L1  C1C3 L2  C2C4	Ringer volume is off.*1 (page 28, 39)
	Call sharing mode is off. (page 42)

Item	Meaning
 L1 L2	“Greeting only” or “Greeting1&Only” is selected. Caller messages are not recorded.*2 (page 55)
L1 L2	– A landline call is being done on that line. – The landline is selected for the setting.
C1 C2 C3 C4	– A cellular call is being done on that line. – The cellular line is selected for the setting.
	Power back-up mode is on. (page 12)
	Blocked call (page 44)
In use:	Someone is using the corresponding line.

*1 Corresponding lines (L1, L2: landline, C1-C4: cellular line) are indicated next to the item.

*2 Corresponding landline number(s) is(are) indicated next to the item.

CELL indicators on the base unit

The CELL indicators show each cellular line status.

Status	Meaning
On	A cellular phone is connected. Ready to make/receive cellular calls.
Flashing	<ul style="list-style-type: none"> – The cellular line is in use. – Phonebook entries are being copied from a cellular phone (page 50). – The base unit is searching for the paired cellular phone. – The base unit is pairing a cellular phone. – A cellular call is put on hold.
Flashing rapidly	A cellular call is being received.
Light off	<ul style="list-style-type: none"> – A cellular phone is not paired to the base unit. – A cellular phone is not connected to the base unit (page 20).

Bluetooth HEADSET indicator on the base unit

The HEADSET indicator shows the Bluetooth headset status.

Status	Meaning
On	A Bluetooth headset is connected to the base unit. Ready to use it.
Flashing	<ul style="list-style-type: none"> – A Bluetooth headset is in use – The base unit is searching for the paired Bluetooth headset. – The base unit is pairing a headset. – Mute is turned on.
Flashing rapidly	A landline call is being received.
Light off	<ul style="list-style-type: none"> – The Bluetooth headset is not connected to the base unit. – A Bluetooth headset is not paired to the base unit.

LINE indicator on the base unit

The LINE indicators show the status of each line, respectively, as follows

Status	Meaning
Light off	The line is available.
Light on	The line is in use.
Flashing rapidly	A call is being received.
Flashing	A call is put on hold or the answering system is answering a call.

Language setting

Display language

You can select either “English” or “Español” as the display language. The default setting is “English”.

1. **[MENU]#110**
2. **[↕]**: Select the desired setting. → [SAVE]
3. Proceed with the operation for your unit.

Handset: [OFF]

Base unit: [EXIT]

Voice guidance language

Program this setting using either the base unit or one of the handsets.

Handset / Base unit

1. **[MENU]#112**
2. **[↕]**: Select the desired setting. → [SAVE]
3. Proceed with the operation for your unit.

Handset: [OFF]

Base unit: [EXIT]

Date and time

Program this setting using either the base unit or one of the handsets.

Handset / Base unit

1. **[MENU]** **#** **1** **0** **1**
2. Enter the current month, date, and year by selecting 2 digits for each. **Example:** July 15, 2013 **0** **7** **1** **5** **1** **3**
3. **[OK]**
4. Enter the current hour and minute (12-hour clock format) by selecting 2 digits for each. **Example: 9:30** **0** **9** **3** **0**
5. Proceed with the operation for your unit. **Handset:** **[*]**: Select “AM” or “PM”. **Base unit:** **[AM/PM]**: Select “AM” or “PM”.
6. **[SAVE]**
7. Proceed with the operation for your unit. **Handset:** **[OFF]** **Base unit:** **[EXIT]**

Note:

- When English is selected as the display language, 12-hour clock format is used. When Spanish is selected, 24-hour clock format is used.

Link to cell feature

To use this feature, you must first pair and connect your cellular phones to the base unit (page 18). Your cellular phones must have Bluetooth wireless technology that is compatible with this product. This feature allows you to:

- make or answer cellular calls using your home phone (handset or base unit) with better reception.
- maximize the benefits of cellular services (such as free night and weekend calls, or cellular to cellular call plans) by utilizing unused peak minutes with your home phone.
- conserve the battery power of your cellular phone while the unit is on a cellular call. (We recommend charging your cellular phone during the cellular call as your cellular phone battery is being consumed.)

Important:

- You may pair a maximum of 4 cellular phones and 1 headset. However, the base unit allows only one Bluetooth to be active at a time.
- Locate your cellular phone near the base unit. If the cellular phone is too close to the base unit during a cellular call, you may hear noise. For best performance, we

recommend placing the cellular phone between 0.6 m to 3 m (2 feet to 10 feet) away from the base unit.

Pairing a cellular phone

Program this setting using either the base unit or one of the handsets.

Important:

- For more details and the list of compatible cellular phones, please visit our Web site: shoppnasonic/bluetooth-phone
- Before pairing a Bluetooth enabled cellular phone to the base unit, make sure that no other Bluetooth device such as a Bluetooth headset is connected to your cellular phone.

Handset / Base unit

1. For CELL 1: **[MENU]#6241**

For CELL 2: **[MENU]#6242**

For CELL 3: **[MENU]#6243**

For CELL 4: **[MENU]#6244**

- After the corresponding CELL indicator on the base unit starts flashing, the rest of the procedure must be completed within 5 minutes.

2. Your cellular phone:

While the corresponding CELL indicator is flashing, follow the instructions of your cellular phone to enter the pairing mode.

- Depending on your cellular phone, it may ask you to enter the base unit PIN (default: "0000").

3. Wait until a long beep sounds.

- It may take more than 10 seconds to complete pairing.
- When the CELL indicator lights up, the cellular phone is connected to the base unit. You are ready to make cellular calls.

4. Proceed with the operation for your unit.

Handset: **[OFF]**

Base unit: **[EXIT]**

Note:

- Make sure that your cellular phone is set to connect to this product automatically. Refer to your cellular phone's operating instructions.
- Make sure you cancel your cellular phone's current pairing if you want to pair it to the other line (page 18).

Unpairing a cellular phone

You can cancel the pairing of a cellular phone that is stored in the base unit.

Program this setting using either the base unit or one of the handsets.

Handset / Base unit

1. For CELL 1: **[MENU]#6111**

For CELL 2: **[MENU]#6112**

For CELL 3: **[MENU]#6113**

For CELL 4: **[MENU]#6114**

2. **[↕]**: "Yes" → **[SELECT]**

- When the cellular phone is unpaired, the CELL indicator is turned off.

3. Proceed with the operation for your unit.

Handset: **[OFF]**

Base unit: **[EXIT]**



Useful Information

Error messages

Display message	Cause/solution
<p>Base no power or No link. Re-connect base AC adaptor.</p>	<ul style="list-style-type: none"> • The handset has lost communication with the base unit. Move closer to the base unit and try again. • Unplug the base unit's AC adaptor to reset the unit. Reconnect the adaptor and try again. • The handset's registration may have been canceled. Re-register the handset (page 46).
<p>Busy</p>	<ul style="list-style-type: none"> • No cellular phone is paired to the base unit. Pair a cellular phone (page 18). • The called unit is in use. • Other units are in use and the system is busy. Try again later. • The handset you are using is too far from the base unit. Move closer and try again.
<p>Check tel line1 Check tel line2</p>	<ul style="list-style-type: none"> • The supplied telephone line cord has not been connected yet or not connected properly. Check the connections (page 9). • If you use the unit as a single-line telephone only, erase the message as follows: <p>To erase "Check tel line1", press [MENU]. → #189.</p> <p>To erase "Check tel line2", press [MENU]. → #190</p> <p>When a power failure occurs, the message is displayed again. Erase again as above.</p>
<p>Error!!</p>	<ul style="list-style-type: none"> • Recording was too short. Try again. • Someone is using a cellular line or headset. Try again later. • The phonebook copy is incomplete (page 50). The cellular phone is disconnected from the base unit. Make sure that other Bluetooth devices are not connected to the cellular phone, and try again.



<p>Failed</p>	<ul style="list-style-type: none"> • Although the unit tried to connect to the cellular phone or headset, the connection has been failed. – Someone is using a cellular line or headset. Try again later. – Make sure that the cellular phone or headset is not connected to other Bluetooth devices.
<p>Invalid</p>	<ul style="list-style-type: none"> • There is no handset registered to the base unit matching the handset number you entered. • The handset is not registered to the base unit. Register the handset (page 46).
<p>Requires subscription to Caller ID.</p>	<ul style="list-style-type: none"> • You must subscribe to a Caller ID service. Once you receive caller information after subscribing to a Caller ID service, this message will not be displayed.
<p>Use rechargeable battery.</p>	<ul style="list-style-type: none"> • A wrong type of battery such as Alkaline or Manganese was inserted. Use only the rechargeable Ni-MH batteries noted on page 4, 6.

Troubleshooting

If you still have difficulties after following the instructions in this section, disconnect the base unit's AC adaptor, then reconnect the base unit's AC adaptor. Remove the batteries from the handset, and then insert the batteries into the handset again.

General use

Problem	Cause/solution
<p>The handset does not turn on even after installing charged batteries.</p>	<ul style="list-style-type: none"> • Place the handset on the base unit or charger to turn on the handset.
<p>The unit does not work.</p>	<ul style="list-style-type: none"> • Make sure the batteries are installed correctly (page 10). • Fully charge the batteries (page 11). • Check the connections (page 9). • Unplug the base unit's AC adaptor to reset the unit. Reconnect the adaptor and try again. • The handset has not been registered to the base unit. Register the handset (page 46).
<p>I cannot pair a cellular phone to the base unit.</p>	<ul style="list-style-type: none"> • Depending on the compatibility of the cellular phone, you may not be able to pair it to the base unit. Confirm that your cellular phone supports the hands-free profile (HFP) specification. • Confirm that the Bluetooth feature of your cellular phone is turned on. You may need to turn this feature on depending on your cellular phone. • The Bluetooth technology on your cellular phone may not be functioning normally. Turn off and on your cellular phone. • If your cellular phone is already connected to another Bluetooth device such as a Bluetooth headset, turn it off or disconnect it from your cellular phone. • Some cellular phones may require you to enter the base unit PIN to pairing. Confirm that you entered the correct PIN.
<p>I cannot connect a cellular phone to the base unit.</p>	<ul style="list-style-type: none"> • Confirm that your cellular phone is turned on. • Confirm that your cellular phone is within base unit range (page 15). • Depending on the state of the wireless environment, such as the presence of any electrical interference, there may be a delay even if the auto connection feature is turned on. You can connect to the base unit manually (page 20).



	<ul style="list-style-type: none"> • The cellular phone has not been paired to the base unit. Pair the cellular phone (page 18). • If your cellular phone is already connected to another Bluetooth device such as a Bluetooth headset or other Panasonic DECT phone, disconnect the device, then perform the connecting procedure to the base unit. • If your cellular phone is already registered on another Panasonic DECT phone, this function will not work properly. We strongly recommend that you remove the registration of this phone on both your cellular phone and on the other Panasonic DECT phone.
--	---





I cannot hear a dial tone.	<ul style="list-style-type: none"> • Make sure that the CELL indicator lights up (page 15). • The base unit's AC adaptor or telephone line cord is not connected. Check the connections. • Disconnect the base unit from the telephone line and connect the line to a known working telephone. If the working telephone operates properly, contact our service personnel to have the unit repaired. If the working telephone does not operate properly, contact your phone service provider.
The base unit beeps.	<ul style="list-style-type: none"> • New messages have been recorded. Listen to the new messages (page 56).

Menu list

Problem	Cause/solution
The display is in a language I cannot read.	<ul style="list-style-type: none"> • Change the display language (page 16).
I cannot register a handset to a base unit.	<ul style="list-style-type: none"> • The maximum number of handsets (6) is already registered to the base unit. Cancel unused handset registrations from the base unit (page 46).

Battery recharge



Problem	Cause/solution
<p>The handset beeps and/or  flashes.</p>	<ul style="list-style-type: none"> • Battery charge is low. Fully charge the batteries (page 11).
<p>I fully charged the batteries, but</p> <ul style="list-style-type: none"> -  still flashes, -  is displayed, or - the operating time seems to be shorter. 	<ul style="list-style-type: none"> • Clean the battery ends ( , ) and the charge contacts with a dry cloth and charge again. • It is time to replace the batteries (page 10).

Making/answering calls, intercom

Problem	Cause/solution
 is displayed.	<ul style="list-style-type: none"> • The handset is too far from the base unit. Move closer. • The base unit's AC adaptor is not properly connected. Reconnect AC adaptor to the base unit. • The handset is not registered to the base unit. Register it (page 46).
Noise is heard, sound cuts in and out.	<ul style="list-style-type: none"> • You are using the handset or base unit in an area with high electrical interference. Re-position the base unit and use the handset away from sources of interference. • Move closer to the base unit. • If you use a DSL/ADSL service, we recommend connecting a DSL/ADSL filter between the base unit and the telephone line jack. Contact your DSL/ADSL provider for details.
The handset or base unit does not ring.	<ul style="list-style-type: none"> • The ringer volume for landline is turned off. Adjust the ringer volume (page 40). • The ringer volume for cellular line is turned off. Adjust the ringer volume (page 39). • When one handset is selected to ring for cellular calls, other units do not ring. To change the selection, see page 20. R Silent mode is turned on. Turn it off (page 44).
I cannot make local calls with the handset or base unit using a cellular line.	<ul style="list-style-type: none"> • You need to add your area code when making cellular calls. Store your area code in order to automatically add it to the beginning of the 7-digit phone number when making cellular calls (page 20).
I cannot make or answer cellular calls with the handset or base unit.	<ul style="list-style-type: none"> • Depending on the cellular phone's compatibility, you may not be able to make or answer cellular calls even if the cellular phone is connected to the base unit. • Make sure that the CELL indicator lights up and the cellular phone is connected to the base unit (page 20).

	<ul style="list-style-type: none"> • If someone is talking on a cellular call or using the headset, you cannot use the cellular feature. There can be only one active Bluetooth connection at a time. • The cellular phone is being used separately from your system.
I can make and answer cellular calls but cannot hear a sound.	<ul style="list-style-type: none"> • The Bluetooth technology on your cellular phone may not be functioning normally. Turn off and on your cellular phone. • Disconnect and reconnect the base unit AC adaptor and try again.
I cannot switch cellular calls from the unit to the cellular phone.	<ul style="list-style-type: none"> • Your cellular phone may not support this feature. Refer to the operating instructions of your cellular phone.
I cannot make a call using the landline.	<ul style="list-style-type: none"> • The dialing mode may be set incorrectly. Change the setting (page 16).
I cannot make long distance calls.	<ul style="list-style-type: none"> • Make sure that you have long distance service.

Caller ID/Talking Caller ID



Problem	Cause/solution
Caller information is not displayed.	<ul style="list-style-type: none"> • You must subscribe to Caller ID service. Contact your phone service provider for details. • If your unit is connected to any additional telephone equipment such as a Caller ID box or cordless telephone line jack, plug the unit directly into the wall jack. • If you use a DSL/ADSL service, we recommend connecting a DSL/ADSL filter between the base unit and the telephone line jack. Contact your DSL/ADSL provider for details. • The name display service for landline calls may not be available in some areas. Contact your phone service provider for details. • Other telephone equipment may be interfering with this unit. Disconnect the other equipment and try again.
Caller information is displayed or announced late.	<ul style="list-style-type: none"> • Depending on your phone service provider, the unit may display or announce the caller's information at the 2nd ring or later. • Move closer to the base unit.



<p>Caller information is not announced.</p>	<ul style="list-style-type: none"> • The ringer volume for landline is turned off. Adjust the ringer volume (page 40). • The ringer volume for cellular line is turned off. Adjust the ringer volume (page 39). • When one handset is selected to ring for cellular calls, other units do not announce caller information. To change the selection, see page 19. • The Talking Caller ID feature is turned off. Turn it on (page 41). R The ring as cell mode is set to “On (without Talking CID)”. To change the mode, see page 19. • The number of rings for the answering system is set to “2 rings” or “Toll saver”. Select a different setting (page 60).
<p>The caller list/incoming phone numbers are not edited automatically.</p>	<ul style="list-style-type: none"> • The Caller ID number auto edit feature is turned off. Turn it on and try again (page 42). • You need to call back the edited number to activate Caller ID number auto edit.
<p>I cannot dial the phone number edited in the caller list.</p>	<ul style="list-style-type: none"> • The phone number you dialed might have been edited incorrectly (for example, the long distance “1” or the area code is missing). Edit the phone number with another pattern (page 48).
<p>Time on the unit has shifted.</p>	<ul style="list-style-type: none"> • Incorrect time information from incoming Caller ID changes the time. Set the time adjustment to “Manual” (off) (page 41).
<p>The 2nd caller’s information is not displayed during an outside call.</p>	<ul style="list-style-type: none"> • In order to use Caller ID, call waiting, or Call Waiting Caller ID (CWID), you must first contact your phone service provider and subscribe to the desired service. <p>After subscribing, you may need to contact your phone service provider again to activate this specific service, even if you already subscribed to both Caller ID and Call Waiting with Caller ID services (CWID).</p>

Using Bluetooth devices



Problem	Cause/solution
<p>I cannot copy phonebook entries from a cellular phone.</p>	<ul style="list-style-type: none"> • Confirm that the cellular phone supports Bluetooth wireless technology. • Confirm that the cellular phone supports the Phone Book Access Profile (PBAP) or Object Push Profile (OPP) specification. • If the cellular phone is already connected to another Bluetooth device such as a Bluetooth headset, turn it off or disconnect it from the cellular phone. • Someone is using a cellular line or headset. Try again later. • Turn the cellular phone off, then turn it on and try again. • If an entry is already stored in the unit's shared phonebook, the entry cannot be copied even by selecting another group.
<p>I cannot have a conversation using the headset.</p>	<ul style="list-style-type: none"> • Your Bluetooth headset is not paired. Pair it (page 51). • Turn your headset off, then turn it on and try again.



<p>Noise is heard during a call on the headset.</p>	<ul style="list-style-type: none"> • A Bluetooth headset can communicate with the base unit within a range of approximately 10 m (33 feet). The connection may be subject to interference from obstructions such as walls or electronic devices. Move closer to the base unit.
<p>I cannot connect my headset to the base unit.</p>	<ul style="list-style-type: none"> • Confirm that your headset is turned on. • If your headset is already connected to another Bluetooth device such as your cellular phone, disconnect the headset from your cellular phone, then perform the connecting procedure from the base unit. • If someone is using a cellular line, you cannot connect the headset. There can be only one active Bluetooth connection at a time. • The headset has not been paired to the base unit. Pair the headset (page 51).
<p>Some headset enhanced features are not available.</p>	<ul style="list-style-type: none"> • The base unit does not support enhanced features such as Last number redial or Call reject.
<p>An error tone is heard when I try to program the Bluetooth feature.</p>	<ul style="list-style-type: none"> • The Bluetooth feature cannot be accessed immediately after connecting the AC adaptor to the base unit. Wait a few seconds and try again. • The headset has not connected to the base unit yet, even though you performed the connecting procedure setting. Wait a few seconds and try again.
<p>Text message (SMS) alert is not announced.</p>	<ul style="list-style-type: none"> • The text message (SMS) alert announcement depends on the “Ring as cell (limited)” setting (page 19) and the “Talking Caller ID” setting (page 41). <p>To make the unit announce text message (SMS) alerts, there are 2 methods available, depending on whether or not you want the unit to emit the same ring as the cellular phone when a call is being received on the cellular phone.</p> <p>– If you prefer the same ring as the cellular phone, select “On (with Talking CID)” of the “Ring as cell (limited)” setting.</p>



– If you prefer the same ring as the unit, select “Off” of the “Ring as cell (limited)” setting, and select “On” of the “Talking Caller ID” setting on the handset and base unit.

- Confirm that the text message (SMS) alert setting is correctly set (page 51).

Answering system

Problem	Cause/solution
<p>The unit does not record new messages.</p>	<ul style="list-style-type: none"> • The answering system is turned off. Turn it on (page 54). • The answering system does not answer or record calls from cellular lines. • The message memory is full. Erase unnecessary messages (page 56, 57). • The greeting setting is set to “Greeting only” or “Greeting1&Only”. Change the setting (page 54). • If you subscribe to a voicemail service, messages are recorded by your phone service provider, not your telephone. Change the unit’s number of rings setting or contact your phone service provider (page 60). • The answering system can only record calls from 1 line at a time.
<p>I cannot operate the answering system remotely.</p>	<ul style="list-style-type: none"> • The remote access code is not set. Set the remote access code (page 59). • You are entering the wrong remote access code. If you have forgotten your remote access code, enter the remote access code setting to check your current code (page 59). • The answering system is turned off. Turn it on (page 60). • You cannot operate the answering system when calling a cellular phone paired to the base unit.
<p>The unit does not emit the specified number of rings.</p>	<ul style="list-style-type: none"> • If the first ring is turned off, the number of rings decreases by 1 from the specified number of rings.

Bluetooth PIN

Problem	Cause/solution
<p>I cannot remember the PIN.</p>	<ul style="list-style-type: none"> • Change the PIN using the following method. <p>Handset/Base unit:</p> <ol style="list-style-type: none"> 1. [MENU]#619 2. *7000 3. Enter the new 4-digit PIN. → [OK] 4. Enter the new 4-digit PIN again. → [SAVE] → [OFF]/[EXIT]

Liquid damage

Problem	Cause/solution
<p>Liquid or other form of moisture has entered the handset/base unit.</p>	<ul style="list-style-type: none"> • Disconnect the AC adaptor and telephone line cord from the base unit. Remove the batteries from the handset and leave to dry for at least 3 days. After the handset/base unit are completely dry, reconnect the AC adaptor and telephone line cord. Insert the batteries and charge fully before use. If the unit does not work properly, contact an authorized service center.

Caution:

- To avoid permanent damage, do not use a microwave oven to speed up the drying process.

Warning

This content is compiled from multiple sources and is provided for reference purposes only. It may not be complete or fully applicable to all situations. If you are unable to resolve your issue, please contact the product manufacturer or an authorized service provider for official support.

