

Installing your washer

Drain facility

- The recommended height of the standpipe is 39 in / 99 cm. The drain hose must be routed through the drain hose clip to the standpipe. The standpipe must be large enough to accept the outside diameter of the drain hose. The drain hose is attached to the washer at the factory.

Flooring

- For best performance, you must install your washer on a solidly constructed floor. Wood floors may need to be reinforced to minimize vibration and/or unbalanced load situations. Carpeting and soft tile surfaces are contributing factors to vibration which can cause your washer to move slightly during the spin cycle.
- Never install your washer on a platform or weakly supported structure.

Location considerations

- Do not install your washer in areas where water may freeze, since your washer will always retain some water in its water valve, pump, and hose areas. Frozen water can damage the belts, the pump, hoses, and other components.

Alcove or closet installation

MINIMUM CLEARANCES FOR CLOSET AND ALCOVE INSTALLATIONS:

Sides – 1 in / 25 mm

Rear – 6 in / 152 mm

Closet Front – 2 in / 51 mm

TOP - 21 in / 533 mm

Gap between end of water valve and the wall

- Case 1. Assemble supply hose after installing: Over 3.9 in (10 cm).
- Case 2. Assemble supply hose before installing: Over 2.8 in (7cm).

If the washer and dryer are installed together, the closet front must have at least a 72 in² (465 cm²) unobstructed air opening. Your washer alone does not require a specific air opening.

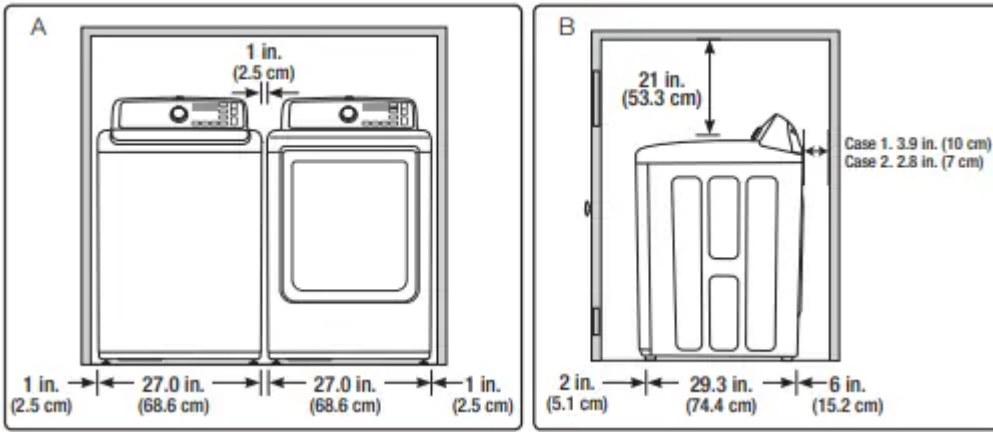

A. Recessed area

B. Side view - closet or confined area

WA45M7050A*, WA45N7150A*

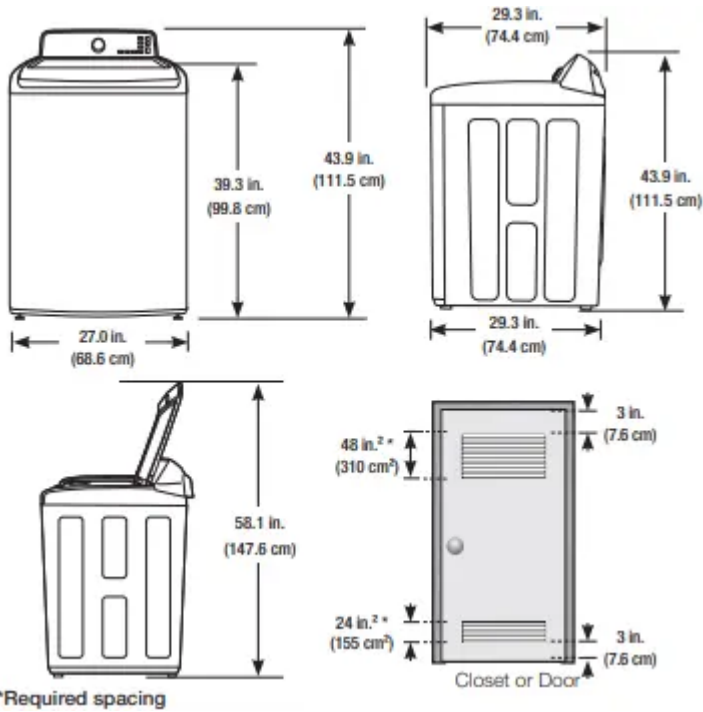

WA50M7450A*, WA50N7350A*



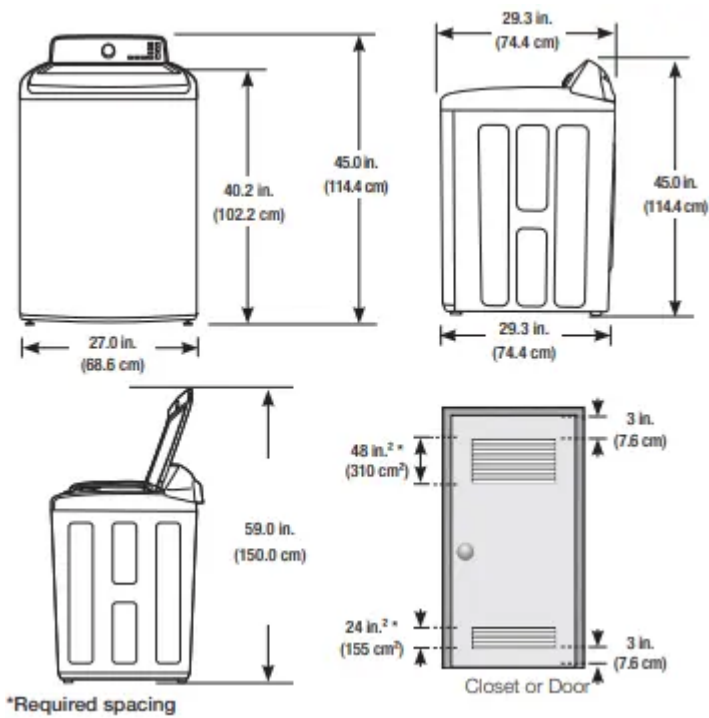

IMPORTANT NOTE TO INSTALLER

Please read the following instructions carefully before installing your washer.

These instructions should be retained for future reference.

We recommend you hire a professional to install this washer.

Installation flow chart

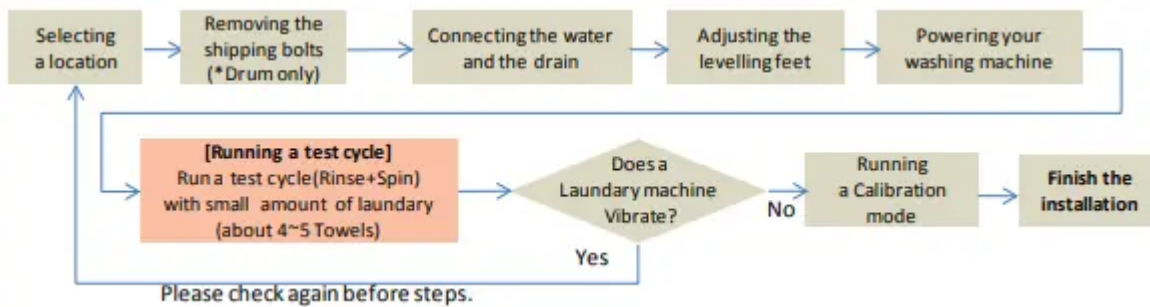

STEP 1 Selecting a Location

Before you install the washer, make sure the location:

- Has a hard, level surface without carpeting or flooring that may obstruct ventilation.
- Is away from direct sunlight.
- Has adequate ventilation.
- Is not exposed to freezing temperatures (temperatures under 32 °F or 0 °C).
- Is away from heat sources such as oil or gas.

- Has enough space so that the washer doesn't rest on its power cord. STEP 2 Connecting the water and the drain

Connecting the water supply hose

- Before installing the water supply hoses, make sure there are rubber gaskets inside the fittings at both ends of each new water hose. Installing the water supply hoses without rubber gaskets can cause water leakage.
- When you initially install the washer, be sure to use new hoses. Failing to do so may result in a water leakage or overflow and may damage your property.
- Do not connect multiple water supply hoses together to increase the length of the supply hose. Hoses connected this way can leak and the leakage can cause electrical shock. If a hose is too short, replace the hose with a longer, high pressure hose.

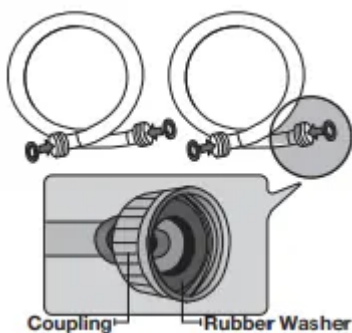

- Connect the ends of the water supply hoses to the HOT and COLD faucets.
- Tighten the fittings by hand until they are snug, and then tighten them an additional two-thirds of a turn with a plier.

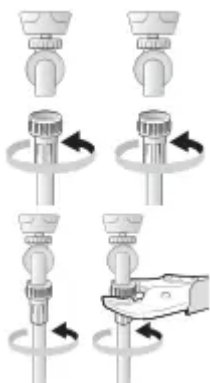

- Place the unconnected ends of the hoses into a bucket and open the faucets connected to the two water supply hoses for 10 or 15 seconds to remove any foreign substances from the hoses. Close the faucets before continuing.



- Connect the ends of the water supply hoses to the water supply intake connections at the back of the washer.

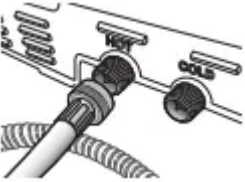

- Tighten the fittings by hand until they are snug, and then tighten them an additional two-thirds of a turn with a plier.

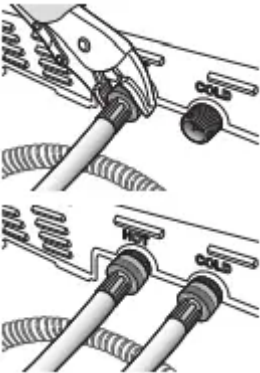

- Turn on the HOT and COLD water supplies and check all the water supply intake connections and the faucets for water leaks.

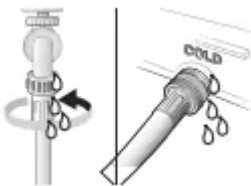

STEP 3 Leveling your washer

See if the washer is level by checking the position of the tub:

- Slide the washer into position.
- Open the lid of the washer, and pour the water into the tub to just below the pulsator level.

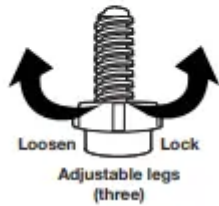
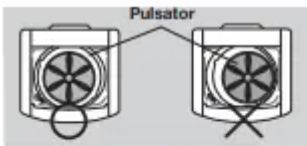

- If the washer is level, the pulsator is positioned at the center of the water as shown in the figure. If not, level your washer by turning the front leveling feet clockwise or counterclockwise as necessary.

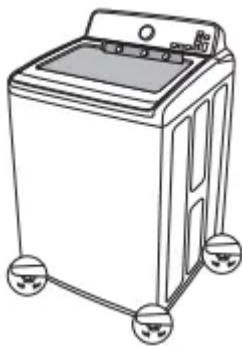

STEP 4 Powering your washer

- Plug the power cord into a 3-prong, well grounded 120 volt 60 Hz approved electrical outlet protected by a 15-amp fuse or comparable circuit breaker.
- Your washer is grounded through the third prong of the power cord when plugged into a three-prong grounded electrical outlet.

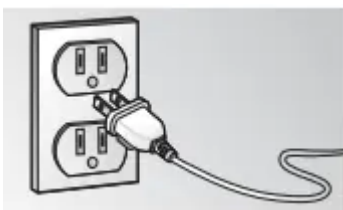

STEP 5 Running a test cycle

Run a test cycle as follows to check if your washer is properly installed.

- Load about 6 pounds of laundry into the tub.
- Press the Power button to turn on your washer.
- Select the Rinse+Spin cycle by turning the Cycle Selector.
- Press the Start/Pause button to start the test cycle.
- The washer should not rock or vibrate excessively when water is supplied or when washing or spinning, and should drain well during the spin cycle.

STEP 6 Calibration mode

Your Samsung washing machine detects the laundry weight automatically. For more accurate weight detection, please run Calibration Mode after the installation.

To run Calibration Mode, follow these steps:

- Remove laundry or any contents in the machine.
- Press the Temp. and Delay End buttons simultaneously, and then press the Power button. The machine turns on.
- Press the Start/Pause button to activate “Calibration Mode”.
- The pulsator rotates clockwise and counterclockwise for approximately 1 minute.
- When “Calibration Mode” is finished, “End” (WA50M7450A*, WA50N7350A*) / “0” (WA45M7050A*, WA45N7150A*) appears on the display, and the machine automatically turns off.

The washing machine is now ready for use.

Operating instructions

LOADING YOUR WASHER

- Fill the tub with dry, unfolded clothes evenly around in order to enhance washing efficiency and prevent excess wear, or wrinkling of the load. For optimal washing performance, make sure the laundry is piled up evenly.
- Wash delicate items such as bras, hosiery, and other lingerie in the Delicates cycle with similar lightweight items.
- When washing big bulky items or a few smaller items that don't fill the tub completely – a rug, a pillow, stuffed toys, or one or two sweaters, for example – add a few towels to improve spin performance.
- Do not insert bulky items except for Bedding in this cycle.



To add a forgotten item:

- Press the Start/Pause button to pause the washer.
- Wait for the door to unlock automatically, and then open the door.
- Add the item, close the door, and then press the Start/Pause button. The cycle will resume.

GETTING STARTED

- Load your washer.
- Add liquid (or powder) detergent and additives to the dispenser (see pages 24~26).
- Select the appropriate cycle and options for the load (see pages 18~23).
- Close the lid.
- Press the Start/Pause button.
- The Wash Indicator light illuminates.
- The estimated cycle time will appear in the display. The time may fluctuate to indicate the time remaining in the cycle better.
- Before your washer starts to fill, it will make a series of clicking noises to check the door lock and do a quick drain.

Washing a load of laundry

OVERVIEW OF THE CONTROL PANEL

WA50M7450A*, WA50N7350A*

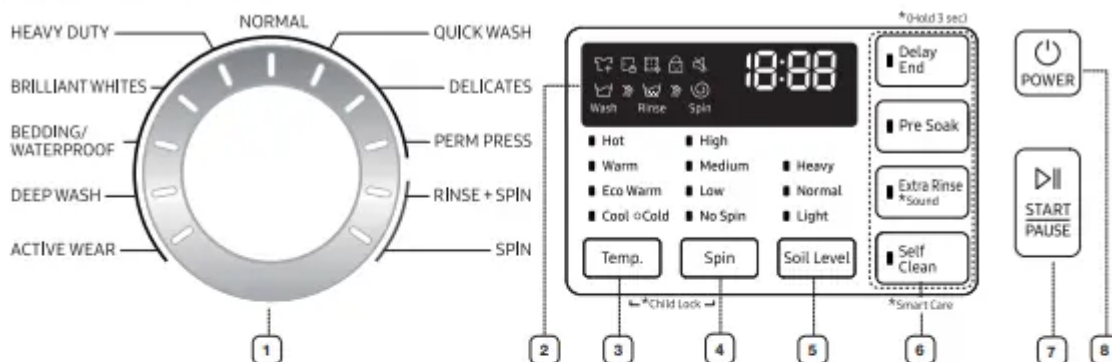

WA45M7050A*, WA45N7150A*

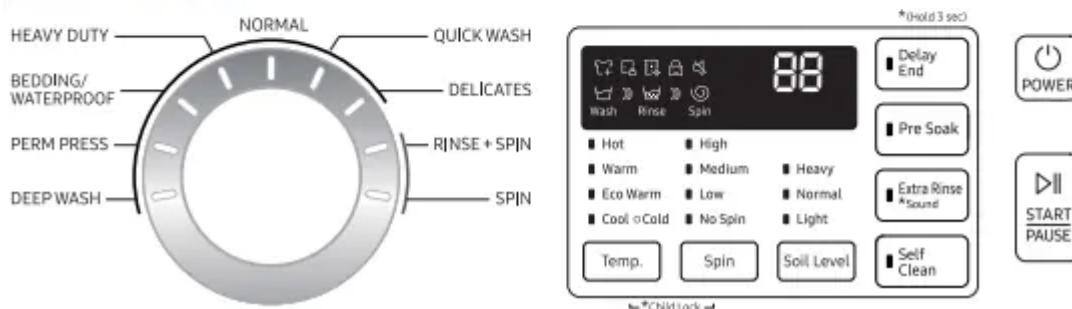

Cycle Selector

Select the appropriate cycle for the type of load.

The cycle you select determines the tumble pattern and spin speed for the cycle.

- **NORMAL** - For most fabrics including cottons, linens, and normally soiled garments.

- HEAVY DUTY - For sturdy, colorfast fabrics and heavily soiled garments.
- BRILLIANT WHITES (WA50M7450A*, WA50N7350A*) - For white fabrics with or without bleach.
- BEDDING/WATERPROOF - For bulky and large items, such as comforters, blankets and sheets. When washing comforters, use liquid detergent, waterproof or water-resistant items.
- DEEP WASH - Use more water in washing and rinsing.
- DELICATES - For sheer fabrics, bras, lingerie, silks, and other handwash- only fabrics. For best results, use liquid detergent.
- PERM PRESS - For wash-and-wear, synthetic fabrics, and lightly to normally soiled garments.
- ACTIVE WEAR (WA50M7450A*, WA50N7350A*) - Use this cycle to wash exercise wear such as sports jerseys, training pants, shirts/tops and other performance clothing. This cycle provides effective soil removal with gentle action for special fabric care.
- QUICK WASH - For lightly soiled garments needed quickly.
- SPIN - Drains the water and spins at a high speed.
- RINSE + SPIN - Use for loads that need rinsing only or to add rinse-added fabric softener to a load.

Display

- Provides instructions and diagnostics while keeping you updated on the cycle status and time remaining.

Temp. selection button

Press the button repeatedly to cycle through the different water temperature options.

- Hot - Whites and heavily soiled, colorfast items.
- Warm - Colorfast items.
- Eco Warm - Moderately soiled, colorfast items; most wrinkle-free items.
- Cool - Brightly colored, very lightly soiled items.
- Cold - Cold water with no warm water added.

Spin selection button

Press the button repeatedly to cycle through the different spin speed options.

- High - Use for underwear, t-shirts, jeans, and sturdy cottons.
- Medium - Use for jeans, wrinkle-free or wash-and-wear items, and synthetics.
- Low - Use for delicate items needing a slow spin speed.

- No Spin - Drains your washer without spinning. Use for extremely delicate items that cannot tolerate any spin.

Soil Level selection button

Press the button to select the soil level/washing time.

- Heavy - For heavily soiled loads.
- Normal - For moderately soiled loads. This setting is best for most loads.
- Light - For lightly soiled loads.

Select Cycle Option

Press these buttons to select different cycle options.

- Extra Rinse - Change from spray rinse mode to deep rinse mode, and rinse once again.
- Delay End - Delay the end of any cycle for up to 19 hours in one-hour increments. Displayed hour indicates the time the wash will be ended.
- Self Clean - Use to clean dirt and bacteria from the drum. Regular use (after every 40 washes) is recommended.
- Pre Soak - It adds 15 minutes soaking time at the start of the wash cycle for better stain removal.

Start/Pause selection button

- Press to pause and restart cycles.

Power button

- Press once to turn your washer on. Press again to turn your washer off. If the washer is left on for more than 10 minutes without any buttons being pressed, the power automatically turns off

Using the Child Lock function

If the lid is opened when the Child Lock function is on, "dE" is displayed and an alarm sounds.

- If the water level in the tub is above the safe water level, "dE" is displayed on the LED display and the washing machine starts to drain water by force after 30 seconds.
- If the water level in the tub is above the safe water level and the Child Lock function is turned on while the door is open, "CL" is displayed on the LED display even if the power of the washing machine is turned off and the washing machine drains water by force.
- Even if the power of the washing machine is turned off if the lid is opened while the water level in the tub is above the Reset water level, "CL" is displayed on the LED display without the alarm sounding and the washing machine starts to drain water. When the draining operation finishes, the power is automatically turned off again.

- You have activated the Child Lock function while the washing machine is running, the Start/ Pause button will not work.
- After the compulsory drain, the “CL” code display blinks at 1 second intervals and the product enters the “CL” mode. (When the product is in the “CL” mode, only the Power button works.)
- To cancel the “CL” mode, you need to turn the power off and then on again.
- To cancel the “dE” mode, deactivate the Child Lock function. To deactivate the Child Lock function, press and hold the Temp. and Spin buttons simultaneously for at least 3 seconds.

Deactivating the Child Lock function

Press and hold both the Temp. and Spin buttons simultaneously for approximately 3 seconds.

- When you deactivate the Child Lock function, the “Child Lock [🔒]” is turned off.
- The Child Lock function prevents children or the infirm from accidentally operating the washer and injuring themselves.

Sound

- The Sound Off function can be selected during all cycles.

Garment

- You can add or take out laundry items even after the wash has started, as long as the “Garment” light is on. Pushing the Start/Pause button unlocks the lid. If you open the lid and want to continue the wash cycle, close the lid, and then press the Start/Pause button.
- If you have activated the Child Lock, you must deactivate it first. See page 20.

Delay End

You can set the washing machine to start your wash automatically at a later time, by choosing a delay time.

The hour displayed indicates the time at which the wash will be ended.

- Set your wash cycle.
- Press the Delay End button repeatedly until the delay time is set.
- Press the Start/Pause button. The “Delay End” indicator will be lit, and the clock will begin counting down until it reaches the set time.
- To cancel a Delay End function, press the Power button and then turn the washing machine on again.

Pre Soak

Use this function when the laundry is heavily contaminated or stained. This function improves the wash performance by adding a Pre Soak cycle.

- If you select this function, the total cycle time is increased by 15 minutes.
- When the Pre Soak cycle starts, the washing machine repeats a wash cycle after supplying water and then performs a 15-minute soak cycle.
- When the Pre Soak cycle is complete, the configured wash cycle starts without draining water.

PREWASH (WATER JET)

Water Jet helps you hand wash before the washing machine starts operation. Water Jet is available only when the door is open with the water level set to less than High.

- Open the door.
- Press the Water Jet button to supply water.

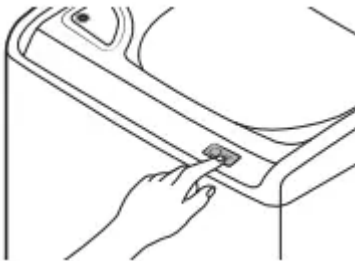

- Hand wash your item.



If you want to hand wash while the machine is operating, press the Start/Pause button to stop operation, and then follow steps 1-3 above.

Maintaining your washer

CLEANING THE EXTERIOR

- Turn off the water faucets after finishing the day's washing.
- This will shut off the water supply to your washer and prevent the unlikely possibility of damage from escaping water. Leave the lid open to allow the inside of your washer to dry out.
- Use a soft cloth to wipe up all detergent, bleach or other spills as they occur.

- Clean the following as recommended:
- Control Panel – Clean with a soft, damp cloth. Do not use abrasive powders or cleaning pads. Do not spray cleaners directly on the panel.

CLEANING THE INTERIOR

- Clean the interior of your washer periodically to remove any dirt, soil, odor, mold, mildew, or bacterial residue that may remain in your washer as a result of washing clothes.
- Failure to follow these instructions may result in unpleasant conditions, including odors and/or permanent stains on your washer or laundry.
- Hard water deposits may be removed, if needed. Use cleaners labeled “Washer safe”.

STORING YOUR WASHER

Washers can be damaged if water is not removed from hoses and internal components before storage. Prepare your washer for storage as follows:

- Select the Quick Wash cycle and add bleach to the automatic dispenser. Run your washer through the cycle without a load.
- Turn the water faucets off and disconnect the inlet hoses.
- Unplug your washer from the electrical outlet and leave your washer lid open to let air circulate inside the drum.
- If your washer has been stored in below-freezing temperatures, allow time for any leftover water in your washer to thaw out before use.

CLEANING MESH FILTER

Clean the mesh filter of the water hose once or twice a year.

- Turn off the washer, and then unplug the power cord.
- Close the faucet.
- Loosen and disconnect the water hose from the back of the washer. Cover the hose with a cloth to prevent water from gushing out.
- Use pliers to pull out the mesh filter from the inlet valve.
- Submerge the mesh filter deeply in water so that the threaded connector is also submerged.
- Dry the mesh filter completely in a shaded area.
- Reinsert the mesh filter into the inlet valve, and reconnect the water hose to the inlet valve.
- Open the faucet.

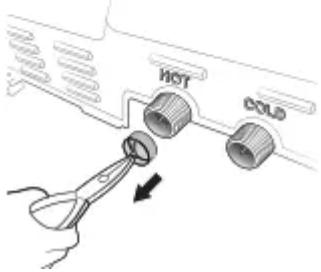
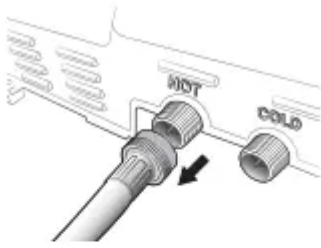

CLEANING THE DISPENSERS (WA45N7150A*, WA45M7050A*)

The automatic dispenser may need to be cleaned periodically due to laundry additive buildup.

- Pull the dispenser drawer straight back until it stops.

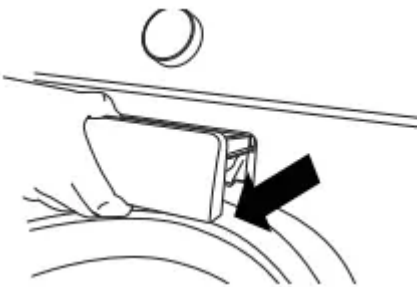

- Tilt the dispenser drawer upward and remove it.

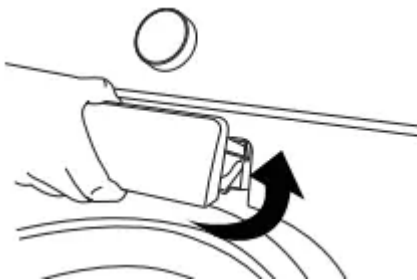

- Remove the inserts from the 3 compartments. Rinse the inserts and the drawer with warm water to remove traces of accumulated laundry products.

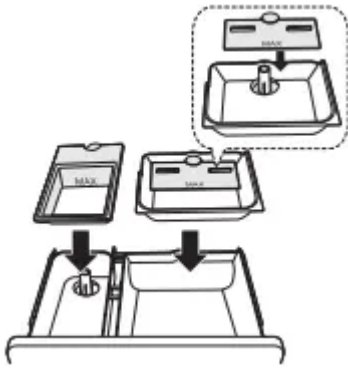

- To clean the drawer opening, use a small, non-metal brush to clean the recess. Remove all residue from the upper and lower parts of the recess.

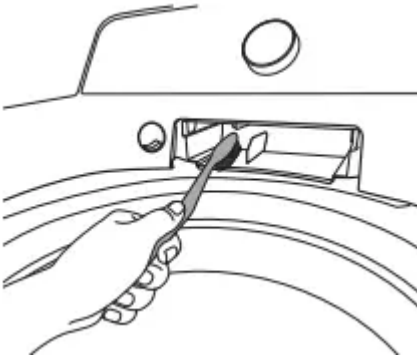

- Return the inserts to the proper compartments and replace the drawer. By placing the dispenser drawer rail (2) on top of the compartment rail (1) (Tilt the dispenser drawer downward and insert it.), and then push the drawer in firmly and slowly.

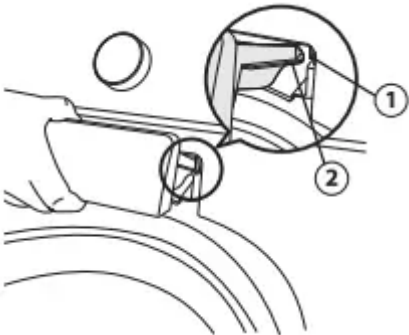

CLEANING THE DISPENSERS (WA50M7450A*, WA50N7350A*)

The automatic dispenser may need to be cleaned periodically due to laundry additive buildup.

- Pull the dispenser drawer straight back until it stops.



- Push the ends of each side of the case at the same time. When you feel the ends push, pull out the dispenser drawer.

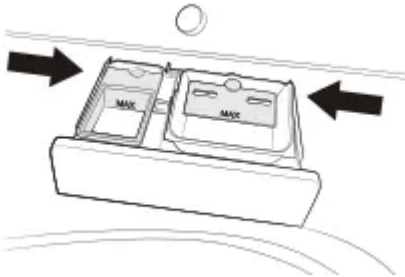

- Remove the inserts from the 3 compartments. Rinse the inserts and the drawer with warm water to remove traces of accumulated laundry products.

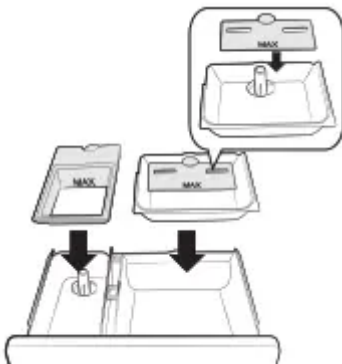

- To clean the drawer opening, use a small, non-metal brush to clean the recess. Remove all residue from the upper and lower parts of the recess.

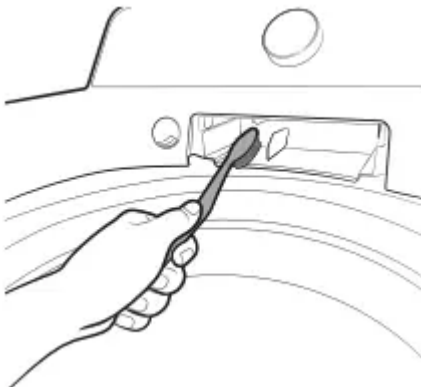

- Return the inserts to the proper compartments and replace the drawer by placing the dispenser drawer rail (B) on top of the compartment rail (A) (Tilt the dispenser drawer downward and insert it). Then push the drawer in firmly and slowly.

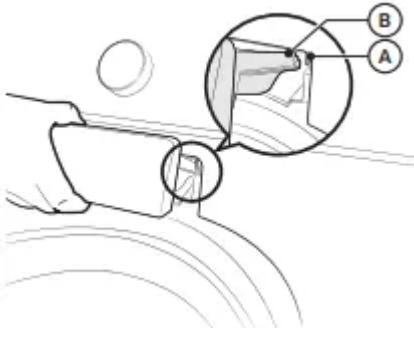

SELF CLEAN

Certain usage and environmental conditions may result in some residue build-up or odor in the washer tub. To prevent this build-up of residue or odor causing bacteria and keep your washer tub fresh and clean, perform the Self Clean cycle at least once a month or every 20 cycles. Perform the recommended procedure below when using the Self Clean cycle.

- Remove all items from the washer tub and ensure the tub is empty. Laundry left in the tub during the
- Self Clean cycle may be damaged.
- Press the Power button.
- Select the Self Clean cycle. Once the Self Clean cycle is selected, the only function that can be set is Delay End.
- Press the Start/Pause button. If you press the Start/Pause button, Self Clean begins.

Troubleshooting

CHECK THESE SOLUTIONS IF YOUR WASHER...

Will not start.

- Make sure the lid is closed.
- Make sure your washer is plugged in.
- Make sure the water source faucets are open.
- Make sure to press the Start/Pause button to start your Washer.
- Make sure Child Lock is not activated. See page 20.
- Before your washer starts to fill, it will make a series of clicking noises to check the lid lock and do a quick drain.
- Check the fuse or reset the circuit breaker

Has no water or not enough water.

- Turn both faucets on fully.
- Straighten the water inlet hoses.

- Disconnect hoses and clean the screens. Hose filter screens may be clogged.

Has detergent remaining in the automatic dispenser after the wash cycle is complete.

- Make sure your washer is running with sufficient water pressure.

Vibrates or is too noisy.

- Make sure your washer is set on a level surface. If the surface is not level, adjust your washer's feet to level the appliance.
- Make sure your washer is not touching any other object.
- Make sure the laundry load is balanced.

Stops

- Plug the power cord into a live electrical outlet.
- Check the fuse or reset the circuit breaker.
- Close the lid and press the Start/Pause button to start your washer. For your safety, your washer will not spin unless the lid is closed.
- Before your washer starts to fill, it will make a series of clicking noises to check the lid lock and do a quick drain.
- There may be a pause or soak period in the cycle. Wait and it may start.
- Check the screens on the inlet hoses at the faucets for obstructions. Clean the screens periodically.

Fills with the wrong temperature water.

- Turn both faucets on fully.
- Make sure the temperature selection is correct.
- Make sure the hoses are connected to the correct faucets. Flush water lines.
- Disconnect the hoses and clean the screens. The hose filter screens may be plugged.
- As your washer is filling, the water temperature may change as the automatic temperature control feature checks incoming water temperature. This is normal.
- While your washer is filling, you may notice just hot and/or just cold water going through the dispenser when you have selected cold or warm wash temperatures. This is a normal function of the automatic temperature control feature as your washer determines the temperature of the water.

Lid locked or will not open.

- Press the Start/Pause button to stop your washer.
- It may take a few moments for the lid lock mechanism to disengage.

Does not drain and/or spin.

- Check the fuse or reset the circuit breaker.

- Straighten the drain hoses. Eliminate kinked hoses. If there is a drain restriction, call for service.
- Close the lid and press the Start/Pause button. For your safety, your washer will not spin unless the lid is closed.

Load is too wet at the end of the cycle.

- Use the High spin speed.
- Use high efficiency detergent to reduce over-sudsing.
- The Load is too small. Very small loads (one or two items) may become unbalanced and not spin out completely.

Leaks water.

- Make sure all hose connections are tight.
- Make sure the end of the drain hose is correctly inserted and secured to the drainage system.
- Avoid overloading.
- Use high efficiency detergent to prevent over-sudsing.

Has excessive suds.

- Use high efficiency detergent to prevent over-sudsing.
- Reduce the detergent amount for soft water, small or lightly soiled loads.
- Non-HE detergent is NOT recommended.

Has an odor.

- Check your Detergent . Excessive suds collect in nooks and crannies and cause mold.
- Run cleansing cycles to sanitize the machine periodically. (Silver Care or Sanitize Cycle or Self Clean)
- Dry the interior of your washer after the total cycle has finished.

INFORMATION CODES

CODE SYMBOL	MEANING	SOLUTION
Ub	Unbalanced load prevents washer from spinning.	Redistribute the load, and then press the Start/ Pause button.
dC/dC1	The washer did not properly lock the door.	Make sure the door is firmly closed. Restart the washer. If the code reappears, call customer service.
dC3	Add Door did not lock	Make sure the Add Door is firmly closed. Restart the washer. If the code reappears, call customer service
ddC	Add Door open while working	
5C	The washer does not drain. The washer may detect a small clog while draining	<ol style="list-style-type: none"> 1. Restart the washer. 2. Select the Spin Only cycle. 3. Press the Start/Pause button to drain the water. <p>If the washer still does not drain, call customer service.</p>
4C	Water is not being supplied to the washer.	<ul style="list-style-type: none"> • Make sure the water taps are open. • Make sure the water hoses are not clogged. • Make sure the water taps are not frozen. • Make sure the washing machine is operating with sufficient water pressure. • Make sure that the cold water tap and the hot water tap are properly connected. • Clean the mesh filter as it may be clogged
4C2	The hot water was supplied from the course washing the delicacy clothes.	<ul style="list-style-type: none"> • Make sure the cold water supply hose is firmly connected to the cold water tap.

		<ul style="list-style-type: none"> If it is connected to the hot water tap, the laundry may be deformed with some cycles.
tC	Temperature sensor problem	Restart the washer. If the code reappears, call customer service.
3C	Motor problem	
9C1/9C2	High/low voltage detected.	
HC	Water temperature control problem. (Heater control)	Call customer service
LC	Water level problem	
OC	Water level sensor problem	
1C	The Water Level sensor is not working properly	
bC2	Jammed button.	
AC	Communication error (SUB (sensor) PBA <-> MAIN PBA)	
AC4	Communication error (WIFI PBA <-> MAIN PBA)	
AC3	Communication error (DR Module <-> MAIN PBA)	
AC5	Communication error (LCD PBA <-> MAIN PBA)	
AC6	Communication error (Inverter PBA <-> MAIN PBA)	
8C	MEMS sensor problem.	
SF	System error.	
PC	Clutch Problem.	
Sud	The washer has detected too many suds. The washer will stop operating until the amount of suds has reduced. The washer will then resume normal operation.	

Ur	Additional rinsing. <ul style="list-style-type: none">• Show additional rinsing in sensing unbalance.• Method of releasing the display.	Any key input.
-----------	--	----------------

Warning

This content is compiled from multiple sources and is provided for reference purposes only. It may not be complete or fully applicable to all situations. If you are unable to resolve your issue, please contact the product manufacturer or an authorized service provider for official support.

