

Installing your washer

Overview your Washer

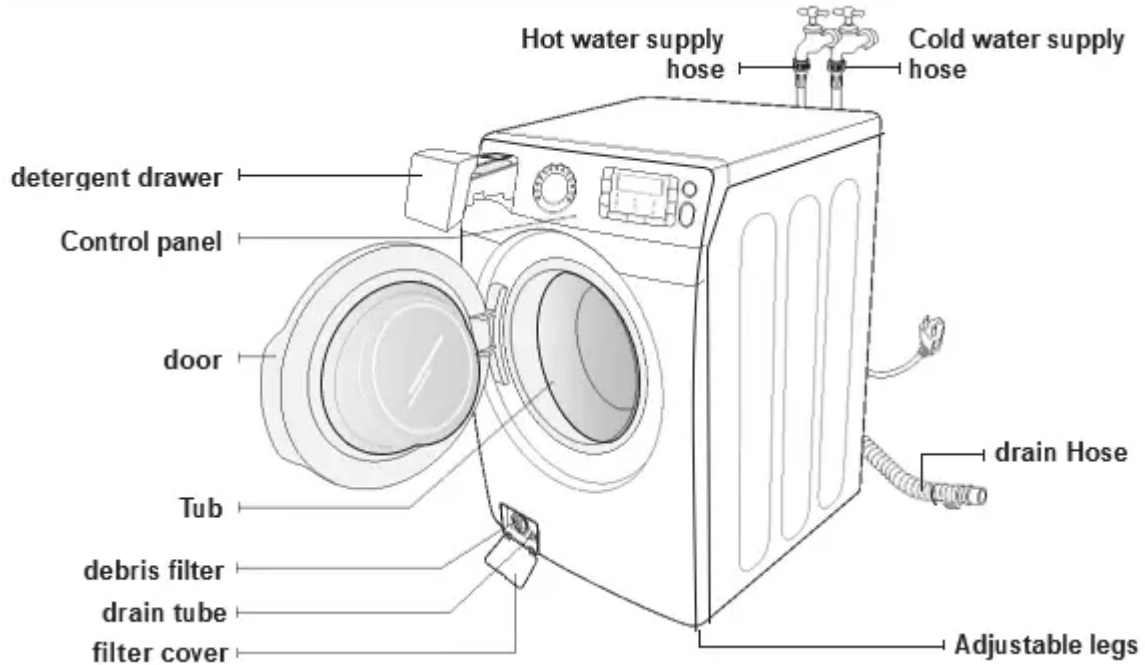

parts supplied



Wrench



bolt hole covers

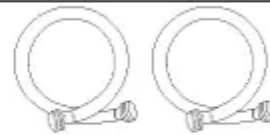

Water supply hoses



Hose guide



User manual book



plastic zip hose tie

Tools needed



pliers



flat screwdriver

Important Note To Installer

STEP 1: Selecting a Location

Before you install your washer, make sure the location:

- Has a hard, level surface without carpeting or flooring that may obstruct ventilation.
- Has no dust, oil and detergent etc.
- Is away from direct sunlight
- Has adequate ventilation
- Will not freeze (below 32°F or 0°C)
- Is away from heat sources such as oil or gas
- Has enough slack for the power cord.
- Doesn't have any carpeting that will obstruct ventilation openings.

STEP 2 Removing the Shipping Bolts

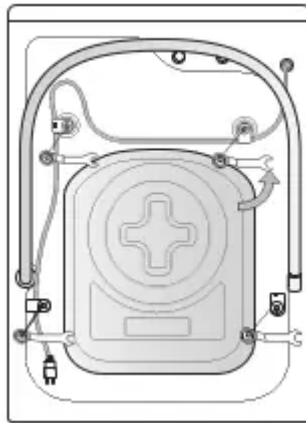

Before using your Washer, you must remove the four shipping bolts from the back of the unit.

1. Loosen all the bolts with the supplied wrench.
2. Slide the bolt and spacer up and remove the bolt with the spacer through the hole in the rear wall of your washer. Repeat for each bolt.
3. Fill the holes with the supplied Bolt Hole Covers.
4. Keep the shipping bolts and spacers for future use.

STEP 3 Installing your Washer

1. Place the drain hose in the drain facility. Be sure an airtight connection is NOT made between the drain hose and the standpipe. The standpipe must be at least 18 in or 46 cm high.

Caution must always be exercised to avoid collapsing or damaging the drain hose. For best results, the drain hose should not be restricted in any way – by elbows, couplings, or excessive lengths. For situations where the drain hose

cannot be conveniently elevated to at least 18 in or 46 cm, the drain hose must be supported.

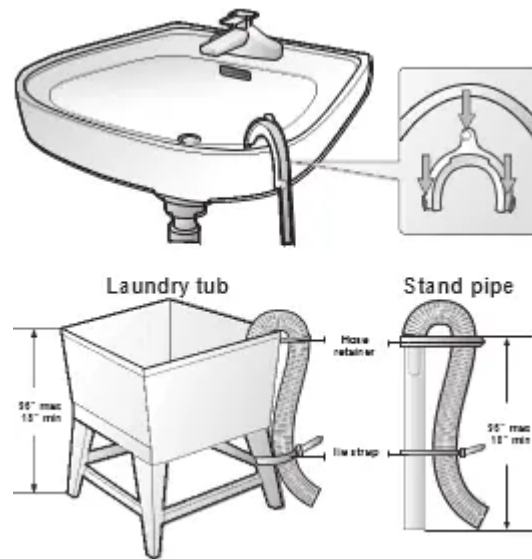

2. Check the inlet hose to ensure a washer is inside each fill hose. Cold Thread the inlet hoses to the HOT and COLD faucet connections.

On the other end of the hose, check for one rubber washer per hose and install each fill hose to the water valve. Make sure the hose with the Hot printed line is attached to the HOT faucet. Tighten by hand until snug, then two-thirds of a turn with pliers.

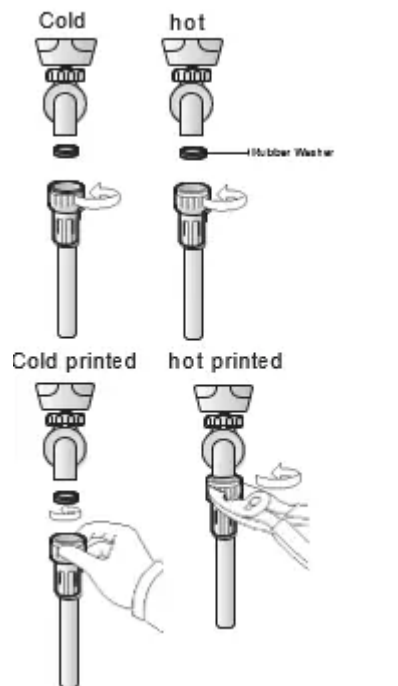

3. Turn on the "HOT" and "COLD" water supply and check all connections at the water valve and the faucet for leaks

4. Plug the power cord into a 3-Prong, well grounded 120 volt 60 Hz approved electrical outlet protected by a 15-amp fuse or comparable circuit breaker.

Your washer is grounded through the third prong of the power cord when plugged into a three-prong grounded receptacle

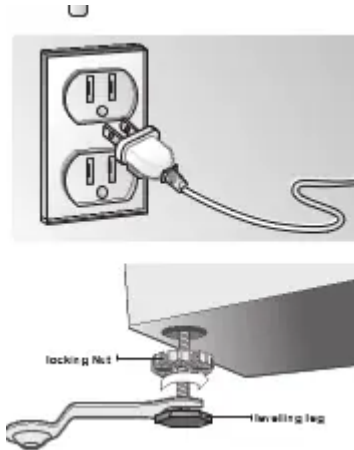

5. Slide your washer into position.

6. Level your washer by turning the leveling legs in or out as necessary by hand or by using the wrench included with your washer. When your washer is level, tighten the locking nuts using the wrench or (-) flathead screwdriver.

Operating instructions

Loading your washer

- You can fill the tub with dry, unfolded clothes; but **DO NOT OVERLOAD** the tub.
- Overloading may reduce washing efficiency, cause excess wear, and possibly cause creasing or wrinkling of the load.
- Wash delicate items such as bras, hosiery, and other lingerie in the Delicates cycle with similar lightweight items.
- When washing big bulky items or a few smaller items that don't fill the tub completely – a rug, a pillow, stuffed toys, or one or two sweaters, for example – add a few towels to improve tumbling and spin performance.

During the spin cycle, the washer may add additional water to redistribute the excessive imbalance inside the drum.

- When washing heavily soiled loads, do not overload your Washer in order to assure good cleaning results.
- To add a forgotten item:

1. Press the Start/Pause Button.

2. Wait for the Door Lock light to go out (5 seconds)
3. Add the item, close the door, and press the Start/Pause Button. After a 10-second pause, the cycle will resume.

Getting Started

1. Load your Washer.
2. Close the door. CAUTION: Push the laundry into the drum completely to prevent the laundry from being caught in the door or from falling out of the drum.
3. Add detergent and additives to the dispenser (see pages 26~27).
4. Select the appropriate cycle and options for the load (see pages 19~21).
5. Press the Start/Pause Button.
6. The Wash Indicator light will illuminate.
7. The estimated cycle time will appear in the display. The time may fluctuate to better indicate the time remaining in the cycle. The actual time required for a cycle may differ from the estimated time in the display depending on the water pressure, water temperature, detergent, and laundry.
8. Before your washer starts to fill, it will make a series of clicking noises to check the door lock and do a quick drain.
 - When the cycle is complete, the Door Lock light will go out and “End” will appear in the display.
 - DO NOT attempt to open the door until the Door Lock light is off. To add a forgotten item, see “Loading your Washer” section. (page 18)
 - When your Washer is restarted after a pause, expect a delay of up to 15 seconds before the cycle continues.
 - Pressing the Power button cancels the cycle and stops your washer.
 - The Pre Wash, Wash, Rinse and Spin indicator lights will illuminate during those portions of the cycle.

Washing a load of laundry

Overview Of The Control Pannel

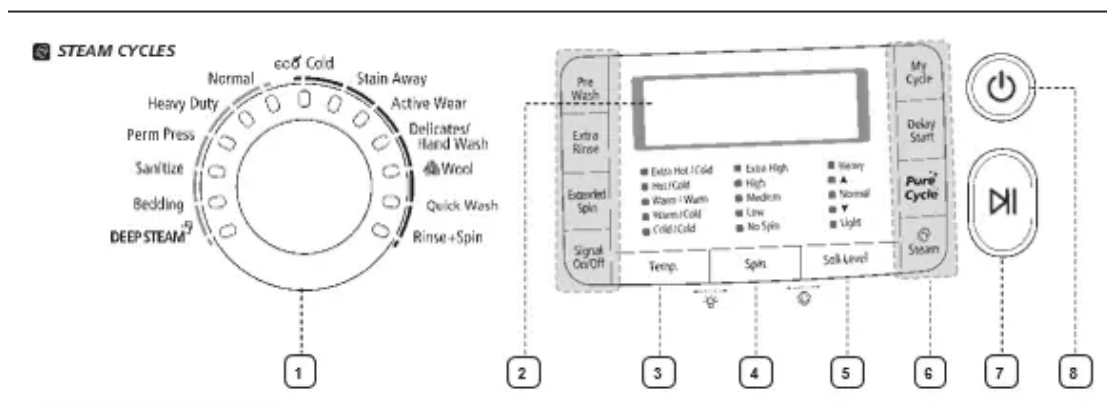

1. Cycle Selector

Select the appropriate cycle for the type of load. This will determine the tumble pattern and spin speed for the cycle.

To minimize wrinkling of laundry, select the Perm Press cycle.

- **Normal** - For most fabrics including cottons, linens, and normally soiled garments. heavy Duty - For sturdy, colorfast fabrics and heavily soiled garments.
- **Perm Press** - For wash-and-wear, synthetic fabrics, and lightly to normally soiled garments.
- **Sanitize** - For heavily soiled, colorfast garments. This cycle heats the water to 150°F to eliminate bacteria. If Pause is selected during the heating portion of the Sanitize Cycle, your Washer door will remain locked for your safety.
- **Bedding** - For bulky items such as blankets and sheets. When you are washing comforters, use liquid detergent.
- **Deep Steam** - For heavily soiled, colorfast garments, this cycle provides high washing temperature and steam and is efficient in cleaning stains.
- **Cycle Selector** - It provides useful daily care for normally and lightly soiled laundry by using only cold water, saving energy and caring fabric.

It cleans as effectively as the warm wash setting on ***conventional Normal** cycle under Normal and Light Soil level options. (Cleaning performance of Eco Cold cycle may not be equal to conventional Normal cycle under heavy soil level option) For best result, it is recommended to use less than 8 pounds. (*conventional Normal cycle - Normal cycle on previous and existing Samsung front loading washers released until 2009 without PowerFoam)

- **Stain Away** - For stained clothes. Stain Away cycle provides outstanding stain removal performance, with the utmost gentle care, avoiding the need for pre-treatment of stains.

For Best stain removal performance , it is recommended to use hot temperature option in this cycle, in which the wash temperature is increased using the internal heater, for overall cleaning of the different stains.

- **Active Wear** - Use this cycle to wash exercise wear such as sports jersey, training pants, shirts/tops and other performance clothing. This cycle provides effective soil removal with gentle action for special fabric care.
- **Delicates/hand Wash** - For sheer fabrics, bras, lingerie silk, and other handwash-only fabrics. For best results, use liquid detergent.
- **Wool** - For machine-washable wool. Loads should be under 8 pounds. For best results, we recommend a load of 4.4 pounds or less.
 - The Wool cycle washes laundry by moving the wash drum horizontally to maintain the characteristics of the wool fibers and to prevent damage to the cloth. It then stops for a while to allow the laundry to soak in the water. This pause in the operation of the Wool cycle is normal.
 - We recommend you use a neutral detergent to prevent damage to the cloth and to improve the washing results.

The wool wash cycle of this machine has been approved by Woolmark for the washing of machine washable Woolmark products, provided that the products are washed according to the instructions on the garment label and those issued by the manufacturer of this washing machine, M1003.

- **Quick Wash** - For lightly soiled garments needed quickly.
- **Rinse + Spin** - Use for loads that need rinsing only or to add rinse-added fabric softener to a load.

2. LCD Display

The large LCD Display is easy to use. It provides instructions and diagnostics while keeping you updated on the cycle status and time remaining.

3. Temperature selection button

Press the button repeatedly to cycle through the different water temperature options.

- **Extra hot/Cold** - Heavily soiled, colorfast items. Only available with the Sanitize cycle.
- **Hot/Cold** - Whites and heavily soiled, colorfast items.
- **Warm/Warm** - Colorfast items. When warm rinse is selected, only the final rinse will be warm.

The other rinses will be cold to conserve energy.

- **Warm/Cold** - Moderately soiled, colorfast items; most wrinkle-free items.
- **Cold/Cold** - Brightly colored, very lightly soiled items.

4. Spin selection button

Press the button repeatedly to cycle through the different spin speed options.
extra high - Removes more water from loads during spin.

To minimize wrinkling of wrinkle-free and no-iron fabrics, DO NOT use the Extra High spin option for these loads, nor overload your Washer.

- **High** - Use for underwear, t-shirts, jeans and sturdy cottons.
- **Medium** - Use for jeans, wrinkle-free or wash-and-wear items and synthetics.
- **Low** - Use for delicate items needing a slow spin speed.
- **No Spin** - Drains your Washer without spinning. Use for extremely delicate items that cannot tolerate any spin.

5. Soil level selection button

Press the button to select the soil level/washing time. (Heavy ▲ à Normal ▼ à Light)

Heavy - For heavily soiled loads.



Normal - For moderately soiled loads. This setting is best for most loads.



Light - For lightly soiled loads

6. Select Cycle Option

Press these buttons to select different cycle options.

- **Pre Wash** - To use this feature, add detergent to the pre wash section of the detergent compartment. When turned on, the washer fills with cold water and detergent, tumbles, then drains and advances to the selected wash cycle. Some cycles cannot be selected with this option.
- **Extra Rinse** - Add an additional rinse at the end of the cycle to more thoroughly remove laundry additives and perfumes.
- **Extended Spin** - Add additional time to remove more water from loads. Signal on/off - Press the Signal button to turn the signal (chime) on or off.
- **My Cycle** - Choose your favorite cycle including temperature, spin, soil level, option, etc.
- **Delay Start** - Any cycle can be delayed for up to 24 hours in one-hour increments. Displayed hour indicates the time at which the wash will be started.

- **Pure Cycle** - Use to clean dirt and bacteria from the drum. Regular use (after every 40 washes) is recommended. No detergent or bleach is needed.
- **Steam** - Press this button to use the Steam Wash function. Steam Wash is available with Heavy Duty, Normal, Perm Press, Sanitize, Bedding cycles. For heavily soiled, colorfast garments, Steam Wash improves stain treatment and uses less water.

7. Start/pause selection the button

Press to pause and restart program



8. Power button

Press once to turn your washer on , press again to turn your washer off. If the washer is left on for than 10 minutes without any buttons being touch

Child Lock

Activating the Child Lock function

Press and hold both the **Spin** and **Soil level** buttons simultaneously for approximately 3 seconds.

- When you activate the Child Lock function, the door locks and the “Child Lock”  lamp illuminates.
- If you press the Start/Pause button after you have activated the Child Lock  function, none of the buttons will work except for the Power button.
- If you press a button when the buttons are locked, the “Child Lock ” lamp blinks.

Pausing the Child Lock function

When the door is locked or the buttons are locked by the Child Lock function, you can pause the Child Lock operation for 1 minute by pressing and holding both the **Spin** and **Soil level** buttons simultaneously for approximately 3 seconds.

- If you pause the Child Lock mode temporarily, the door lock is released for 1 minute for user convenience. During this period, the “Child Lock” lamp blinks.
- If you open the door after the minute is over, an alarm sounds for up to 2 minutes.
- If you close the door within the 2 minutes, the door is locked and the Child Lock  function is reactivated. If you close the door after the 2 minutes, the door is not locked automatically and no alarm sounds.

Deactivating the Child Lock function

Press and hold both the **Spin** and **Soil level** buttons simultaneously for approximately 6 seconds.

- When you deactivate the Child Lock function, the door is unlocked and the “Child Lock ”  is turned off.

WARNING: The Child Lock function prevents children or the infirm from accidentally operating the washer and injuring themselves. If a child enters the washing machine, the child may become trapped and suffocate.

CAUTION: Once you have activated the Child Lock function, it continues working even if the power is turned off. Opening the door by force can result in injury due to damage to the product.

To add laundry after you have activated the Child Lock function, you must first pause or deactivate the Child Lock function.

If you want to open the door of the washing machine when the Child Lock function is activated:

- Pause or deactivate the Child Lock function.
- Turn the washing machine off and then on again.

Spin Only

If you press the power button and then press and hold the Spin button for 2 seconds, the spin time will be displayed on the display panel.

Then, press the Spin button repeatedly until the required spin level is selected, and then press the Start/pause button.

Before pressing the Spin Only button, you can select a cycle with the Cycle Selector. If you have selected a cycle, you can only select the corresponding spin level.

Interior Lamp

1. If the door is opened when the power is on, the Interior Lamp is automatically turned on.
2. If the door is closed when the power is on, the Interior Lamp is automatically turned off.
3. Press the Temp and the Spin buttons simultaneously or the Drum Light button to turn the Interior Lamp on or off.
4. If 4 minutes have passed after the Interior Lamp is turned on, the Interior Lamp is automatically turned off

Select the Language

1. Press the PreWash + Extra Rinse buttons simultaneously for 3 seconds.
2. The “Select the Language” message appears on the display.
3. Turn the Jog Dial to select a language. You can select English, Spanish, or French.
4. Press the Signal button to select the chosen language

Steam

The Steam Wash function injects steam directly into the laundry in the wash tub to increase the wash temperature and enhance the soak effect, thus improving the wash performance.

1. Load the washer.
2. Press the **power** button.
3. Turn the **Cycle Selector** and select a steam cycle. (The **deep Steam** cycle automatically selects the Steam Wash function.)
4. Press the **Steam** button.
5. Add detergent into the dispenser tray for a wash, and add fabric softener up to the marked line.
6. Press the **Start/pause** button. The washer automatically selects the optimal wash conditions by sensing the weight of the laundry.

If steam wash is selected, steam is injected at the most effective time for the detected amount of laundry in order to maximize the effect of the steam.

Washing clothes using the cycle selector

Your new washing machine makes washing clothes easy, using Samsung’s “Fuzzy Control” automatic control system. When you select a wash program, the machine will set the correct temperature, washing time, and washing speed.

1. Press the **power** button.
2. Open the door.
3. Load the articles of clothing one at a time loosely into the drum, without overfilling it.
4. Close the door.
5. Add detergent, softener, and pre-wash detergent (if necessary) into the appropriate compartments. Pre-wash is only available when selecting the

Normal, Perm Press, Sanitize, Bedding, Deep Steam and Heavy Duty cycles. It is only necessary if your clothing is heavily soiled.

6. Use the Cycle Selector to select the appropriate cycle according to the type of material: Normal, Heavy Duty, Perm Press, Sanitize, Bedding, Deep Steam, Eco Cold, Stain Away, Active Wear, Delicates/Hand Wash, Wool, Quick Wash, Rinse + Spin and Spin Only. The relevant indicators will illuminate on the control panel.
7. At this time, you can control the wash temperature, the number of rinse cycles, the spinning speed, and the delay time by pressing the appropriate option button.
8. Press the Start/Pause button on the Cycle Selector and the wash will begin. The process indicator will light up and the remaining time for the cycle will appear in the display.

Pause Option

1. Within 5 minutes of starting a wash, it is possible to add/remove laundry items to/from the wash.
2. Press the Start/Pause button to unlock the door.
3. The door cannot be opened when the water is too HOT or the water level is too HIGH.
4. After closing the door, press the Start/Pause button to restart the wash.

When the cycle is finished: After the total cycle has finished, the power will turn off automatically.

1. Open the door.
2. Remove laundry

FEATURES

Automatic dispenser

Your Washer has separate compartments for dispensing detergent and color-safe bleach, chlorine bleach, and fabric softener. Add all laundry additives to their respective compartments before starting your Washer.

The automatic dispenser **MUST ALWAYS** be in place before starting your Washer.

DO NOT open the automatic dispenser when your washer is running.

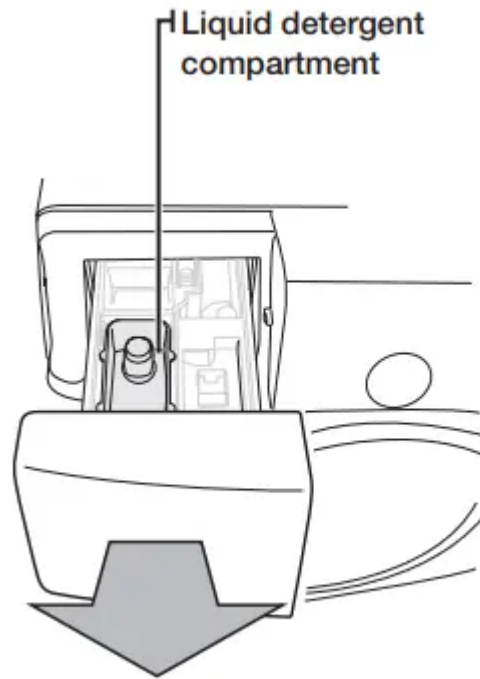

To use:

- Never exceed the manufacturer’s recommendations when adding detergent.
- This compartment holds liquid detergent for the main wash cycle, which is added to the load at the beginning of the cycle.

When using powdered detergent, remove the liquid detergent compartment from the detergent drawer. The washer will not dispense powdered detergent from the liquid detergent compartment.

Detergent compartment

1. Pour the recommended amount of laundry detergent directly into the detergent compartment before starting your Washer.
2. If you are using color-safe bleach, add it with the detergent to the detergent compartment.

When adding color-safe bleach with detergent, it is best if both laundry products are in the same form – granular or liquid



Pre wash compartment

When using the Pre Wash option, detergent should be added to both the Pre Wash compartment and the detergent compartment. The detergent will automatically be dispensed during Pre Wash.

- If high efficiency (HE) detergent is used, add 1/3 of the recommended amount to the Pre Wash compartment and 2/3 of the recommended amount to the detergent compartment.

Bleach compartment (Liquid chlorine bleach only)

1. Add chlorine bleach to the bleach compartment. DO NOT exceed the MAX FILL line.
 2. Avoid splashing or over-filling the compartment.
 3. Your Washer automatically dispenses bleach into the tub at the appropriate time.
 4. The dispenser automatically dilutes liquid chlorine bleach before it reaches the wash load.
- Never pour undiluted liquid chlorine bleach directly onto the load or into the tub. It is a powerful chemical and can cause fabric damage, such as weakening of the fibers or color loss, if not used properly.
 - If you prefer to use color-safe, non-chlorine bleach, add it to the appropriate detergent compartment. DO NOT pour color-safe bleach into the Bleach compartment

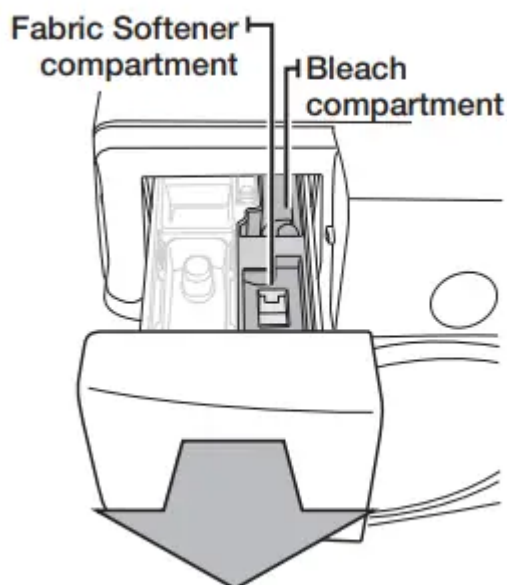

Fabric softener compartment

1. Pour the recommended amount of liquid fabric softener into the softener compartment. For smaller loads, use less than one capful.
 2. Dilute the fabric softener with water until it reaches MAX FILL in the compartment.
 3. The dispenser automatically releases liquid fabric softener at the proper time during the rinse cycle.
- Use the softener compartment ONLY for liquid fabric softeners.
 - DO NOT use the Downy Ball* in the fabric softener compartment with this Washer. It will not add fabric softener at the appropriate time. Use the detergent Compartment.
 - It is not recommended using liquid fabric softener that is too sticky as it may not mix with the water sufficiently.
 - Brand names are trademarks of their respective manufacturers.

Maintaining your washer

Cleaning the exterior

Turn off the water faucets after finishing the day's washing.

This will shut off the water supply to your Washer and prevent the unlikely possibility of damage from escaping water. Leave the door open to allow the inside of your Washer to dry out.

Use a soft cloth to wipe up all detergent, bleach or other spills as they occur. Clean the following as recommended:

- Control Panel – Clean with a soft, damp cloth. Do not use abrasive powders or cleaning pads. Do not spray cleaners directly on the panel.
- Cabinet – Clean with soap and water.

Cleaning the interior

Clean the interior of your Washer periodically to remove any dirt, soil, odor, mold, mildew, or bacterial residue that may remain in your Washer as a result of washing clothes.

Failure to follow these instructions may result in unpleasant conditions, including odors and/or permanent stains on your Washer or laundry.

Hard water deposits may be removed, if needed. Use a cleaner labeled "Washer safe".

Cleaning the Dispensers

The automatic dispenser may need to be cleaned periodically due to laundry additive buildup.

1. Pull the detergent liquid holder out of the detergent compartment.
2. Remove the siphon cap from the fabric softener and bleach compartments.
3. Wash all of the parts under running water.
4. Clean the dispenser recess with a soft brush.
5. Reinsert the siphon cap and push it firmly into place.
6. Push the dispenser back into place.
7. Run a Rinse+Spin cycle without any load in your washer.

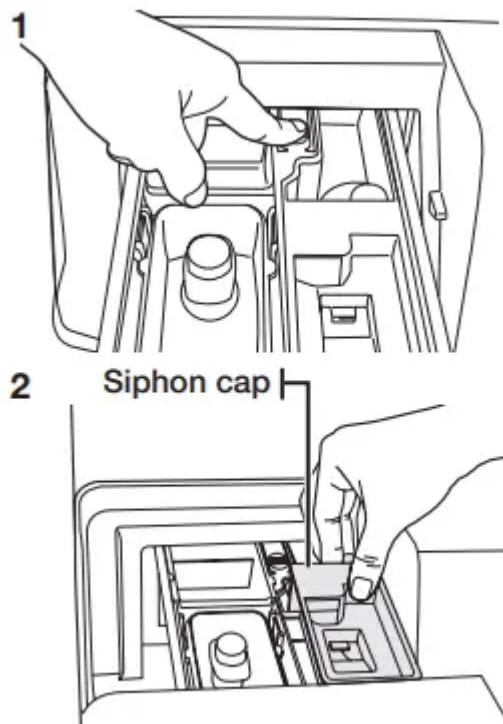

Storing your washer

Washers can be damaged if water is not removed from hoses and internal components before storage. Prepare your Washer for storage as follows:

- Select the Quick Wash cycle and add bleach to the automatic dispenser. Run your Washer through the cycle without a load.
- Turn the water faucets off and disconnect the inlet hoses.
- Unplug your Washer from the electrical outlet and leave your Washer door open to let air circulate inside the tumbler.
- If your Washer has been stored in below-freezing temperatures, allow time for any leftover water in your Washer to thaw out before use.

Cleaning the Debris Filter

1. Open the filter cover by pressing and pulling the handle of the filter cover with your finger

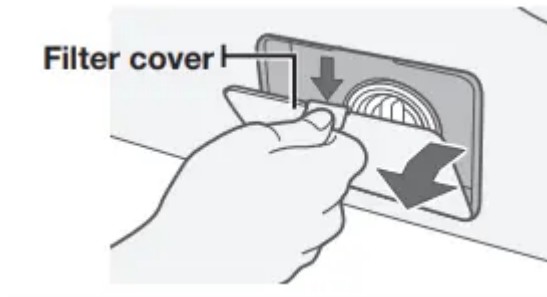

2. Holding the drain cap, pull the drain tube that is hooked on the guide hook to the front. Do not pull the drain tube with excessive force.
3. Place a bowl under the washing machine to catch any remaining water. Then, hold the drain tube with one hand, and turn the emergency drain cap counter clockwise with the other hand to separate it from the drain tube.
4. Drain the remaining water completely.

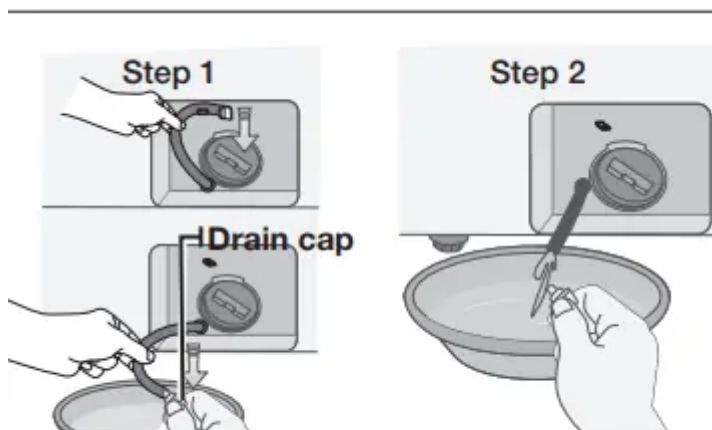

5. Pull out the debris cap and debris filter assembly

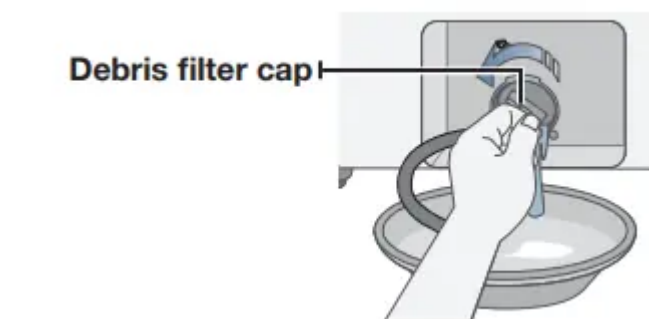

6. Wash any dirt or other material from the debris filter. Make sure the drain pump propeller behind the debris filter is not blocked

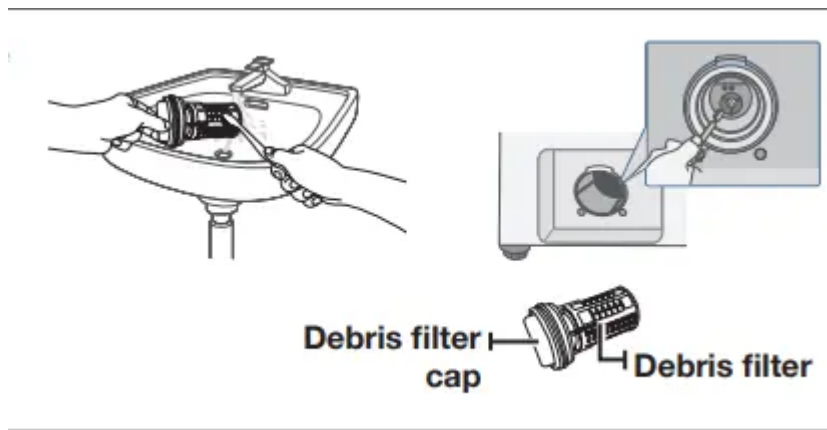

7. When you have finished cleaning the filter, insert the debris cap and filter assembly back into the washer. Turn the debris filter cap clockwise until the indicator on the debris filter cap is in the 12 o'clock position, pointing to the indicator on the washer

8. Re-attach the emergency drain cap to the drain tube, and then hook the tube to the hook guide.

9. Re-install the filter cover the filter cover

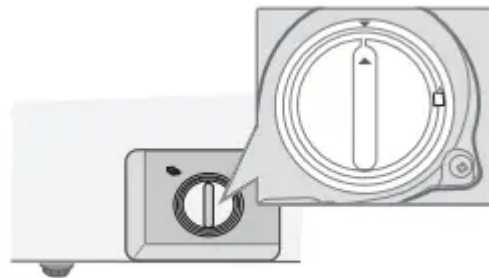

Cleaning the Door Seal/bellow

1. Open the washer door and remove any clothing or items from the washer

2. Inspect the gray colored seal/bellow between the door opening and the basket for stained areas. Pull back the seal/bellow to inspect all areas under the seal/bellow and to check for foreign objects

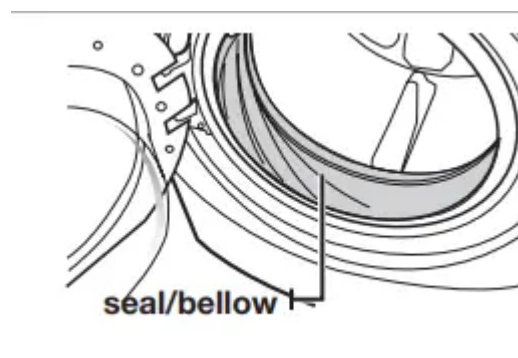

3. If stained areas are found, wipe down these areas of the seal/bellow, using the procedure that follows.

- a)** Mix a dilute solution, using $\frac{3}{4}$ cup (177 mL) of liquid chlorine bleach, and 1 gal. (3.8 L) of warm tap water.
- b)** Wipe the seal/bellow area with the dilute solution, using a damp cloth.
- c)** Let stand 5 minutes.
- d)** Wipe down area thoroughly with a dry cloth and let the washer interior air dry with door open.

Troubleshooting

CHECK THESE POINTS IF YOUR WASHER...

Will not start..

- Make sure the door is firmly closed.
- Make sure your Washer is plugged in.
- Make sure the water source faucets are open.
- Make sure to press the Start/Pause Button to start your Washer
- Make sure Child Lock is not activated;
- Before your Washer starts to fill, it will make a series of clicking noises to check the door lock and do a quick drain.
- Check the fuse or reset the circuit breaker

Has no water or not enough water

- Turn both faucets on fully.
- Make sure the door is tightly closed.
- Straighten the water inlet hoses.
- Disconnect hoses and clean screens. Hose filter screens may be clogged.
- Open and close the door, then press the Start/Pause Button.

Has detergent remaining in the automatic dispenser after the wash cycle is complete

- Make sure your Washer is running with sufficient water pressure.
- Make sure the Detergent Selector dial is in the upper position when using granular detergent

Vibrates or is too noisy

- Make sure your Washer is set on a level surface. If the surface is not level, adjust your Washer feet to level the appliance.

- Make sure that the shipping bolts are removed.
- Make sure your Washer is not touching any other object.
- Make sure the laundry load is balanced.

Stops

- Plug the power cord into a live electrical outlet.
- Check the fuse or reset the circuit breaker.
- Close the door and press the Start/Pause Button to start your Washer.
- For your safety, your Washer will not tumble or spin unless the door is closed.
- Before your Washer starts to fill, it will make a series of clicking noises to check the door lock and do a quick drain.
- There may be a pause or soak period in the cycle. Wait briefly and it may start.
- Check the screens on the inlet hoses at the faucets for obstructions. Clean the screens periodically.

Fills with the wrong temperature water

- Turn both faucets on fully.
- Make sure the temperature selection is correct.
- Make sure the hoses are connected to the correct faucets. Flush water lines.
- Check the water heater. It should be set to deliver a minimum 120° F (49° C) hot water at the tap. Also check the water heater capacity and recovery rate.
- Disconnect the hoses and clean the screens. The hose filter screens may be plugged.
- As your Washer is filling, the water temperature may change as the automatic temperature control feature checks incoming water temperature. This is normal.
- While your Washer is filling, you may notice just hot and/or just cold water going through the dispenser when cold or warm wash temperatures are selected. This is a normal function of the automatic temperature control feature as your Washer determines the temperature of the water.

Door locked or will not open

- Press the Start/Pause Button to stop your Washer.
- Your Washer door will remain locked during the heating portion of the Sanitize Cycle
- It may take a few moments for the door lock mechanism to disengage

Does not drain and/or spin.

- Check the fuse or reset the circuit breaker.
- Straighten the drain hoses. Eliminate kinked hoses. If there is a drain restriction, call for service.
- Close the door and press the Start/Pause Button. For your safety, your Washer will not tumble or spin unless the door is closed.
- Make sure the debris filter is not clogged

Load is too wet at the end of the cycle.

- Use the High or Extra High spin speed.
- Use high efficiency detergent to reduce over-sudsing.
- Load is too small. Very small loads (one or two items) may become unbalanced and not spin out completely.

Leaks water

- Make sure the door is firmly closed.
- Make sure all hose connections are tight.
- Make sure the end of the drain hose is correctly inserted and secured to the drainage system.
- Avoid overloading.
- Use high efficiency detergent to prevent over-sudsing

Has excessive suds

- Use high efficiency detergent to prevent over-sudsing.
- Reduce the detergent amount for soft water, small or lightly soiled loads.
- Non-HE detergent is NOT recommended.

INFORMATION CODES

Error! Unbalanced load

Unbalanced load prevented your washer from spinning.

- Redistribute the load, press the **Start/ pause** button

Error! The Door was unlocked while the washer was running.

Door is unlocked when washer is running

- Press the **Power** button to turn off your washer, then restart the cycle. If the code reappears, call for service.

Error! Door is open.

Door is open when washer is running

- Close the door tightly and restart the cycle.
- If the code reappears, call for service.

Error! The Washer door would not lock.

Your washer failed to lock the door

- Close the door tightly and restart the cycle.
- If the code reappears, call for service.

Error! Water Temperature Control Problem

Water temperature control problem. (Heater control problem)

- Call for service.

Error! Water Level Sensor Problem

Water level sensor problem

- Call for service.

Error! Water Leakage Problem

Your washer has tried to fill but has not reached the proper water level.

- Call for service.

Error! The Door will not unlock.

The door will not unlock.

- Make sure the door is firmly closed.
- Press the **power** button to turn off your washer, then turn it on again. If the code reappears, call for service.

Error! No Draining

Your washer is not draining. It can also mean that the unit senses a small clog while draining.

First of all, clean up the drain filter. Then check the following.
Clean the filter.

1. Turn off the unit for 10 seconds and then turn it on again.
2. Select the Spin Only cycle.
3. Press the **Start/pause** to drain the water.

If it still does not drain, call for service

Error! Low Water Pressure

Your washer has tried to fill but was unsuccessful.

- Make sure the water faucets are open all the way. Check for kinked hoses.
- Check the inlet screens on the fill hoses.
- If you use a Flood Safety Device, then please remove the device and connect the water hoses directly to the unit

Check if the hot water supply hose is connected

- You must connect the hot water supply hose because hot water is supplied by the Auto Temperature Control (A.T.C.) function if the temperature of the cold water is lower than 59°F.

Error! Water Temperature Control Problem

The hot/cold water hose connection is not correct

- Please connect the hot/cold water hose connection correctly

Error! Power Interruption

Problem with control

- Call for service.

Error! Water Supply Problem

A fault is detected in the water level sensor.

- Call for service

Error! A Button is either stuck or is being pressed continuously.

Jammed key

- Call for service

Error! The Motor is not working properly.

Motor problem

- Restart the cycle
- If the code reappears, call for service

Error! Temperature Sensor Problem

Temperature sensor problem.

- Restart the cycle
- If the code reappears, call for service

Error! High/Low Voltage Detected

High/Low voltage detected

- Restart the cycle
- If the code reappears, call for service

Error! Electronic Control Problem

Communication error between SUB PBA and MAIN PBA

- Call for service

Error! Front MEMS Sensor Problem

Front MEMS sensor problem

- Call for service

Error! Rear MEMS Sensor Problem

Rear MEMS sensor problem

- Call for service

Error! Excessive Suds

Too many suds are detected during the washing session. The unit is put on hold until the suds are reduced. Then, the unit will go back to the operation. When it finishes washing, “End” and “Excessive Suds” codes will blink in turn.

- To prevent it, cut down on detergents.

Specification

TYPE	FRONT LOADING WASHER	
DIMENSIONS	Div	Inches (mm)
	A. Height-Overall	38.6 "(981)
	B. Width	27" (686)
	C. Depth with door open 90°	51.2"(1300)
	D. Depth	34.1"(865)

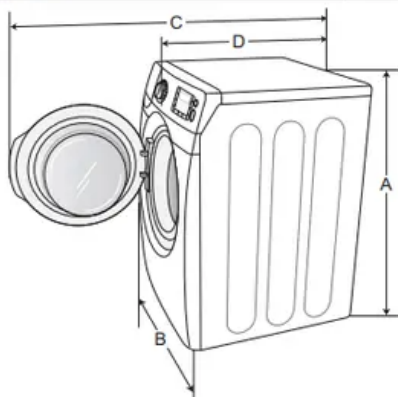

WATER PRESSURE		20-116psi(137-800kPa)	
WEIGHT		110kg (242.5 lb)	
HEATER RATING		900 W	
POWER CONSUMPTION	WASHING	120 V	200 W
	WASHING AND HEATING	120 V	1150 W
	SPIN	120 V	550 W
	DRAIN	120 V	80 W
SPIN REVOLUTION	WF520*	1300 rpm	

Warning

This content is compiled from multiple sources and is provided for reference purposes only. It may not be complete or fully applicable to all situations. If you are unable to resolve your issue, please contact the product manufacturer or an authorized service provider for official support.