

Honeywell Home Programmable Thermostat User Guide

Smart Series: RTH6500WF

Models: RTH6580WF1001, RTH6585R1006

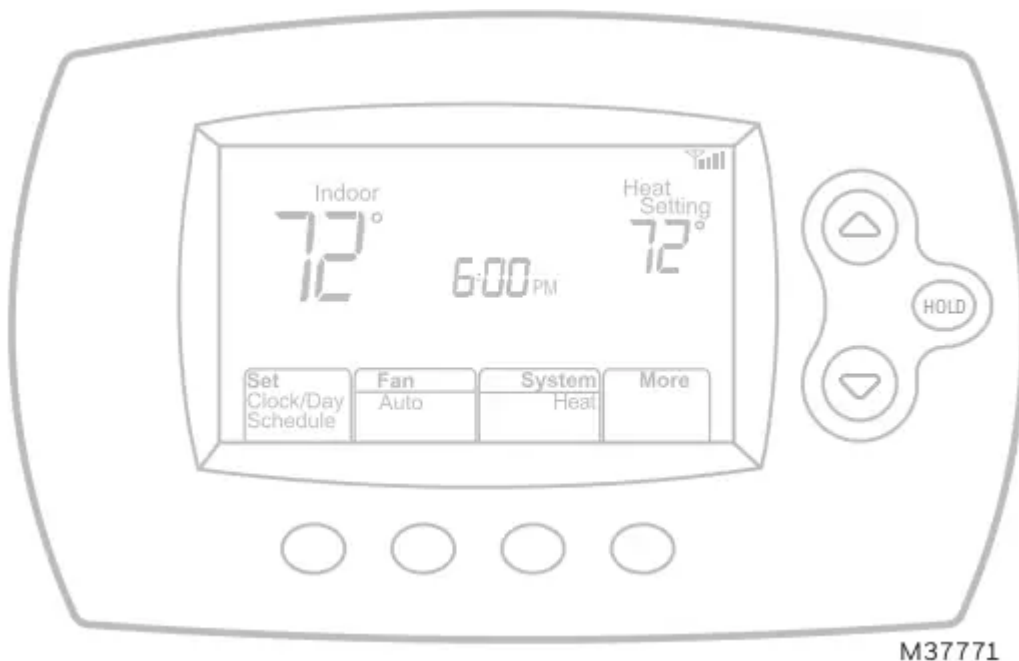

In the box you will find

- + Thermostat
- + Wallplate (attached to thermostat)
- + Screws and anchors
- + Quick Start Guide
- + Thermostat ID Card
- + Wire labels
- + User Guide
- + Quick Reference Card



Input: 24 V~, 60 Hz, 1.0 A.

Precautions and Warnings

A This thermostat works with common 24 V systems such as forced air, hydronic, heat pump, oil, gas, and electric. It will not work with millivolt systems, such as a gas fireplace, or with 120 V/240 V systems such as baseboard electric heat.

A MERCURY NOTICE: Do not place your old thermostat in the trash if it contains mercury in a sealed tube. Contact the Thermostat Recycling Corporation at www.thermostat-recycle.org or 1-800

238-8192 for information on how and where to properly and safely dispose of your old thermostat.

A NOTICE: To avoid possible compressor damage, do not run air conditioner if the outside temperature drops below 50 °F (10 °C).

Features of your thermostat

With your new thermostat, you can:

- + Connect to the Internet to monitor and control your heating/cooling system
- + View and change your heating/cooling system settings
- + View and set temperature and schedules
- + Receive alerts via email and get automatic upgrades

Your new thermostat provides:

- + Smart Response Technology
- + Compressor protection
- + Heat/cool auto changeover

Controls and home screen quick reference



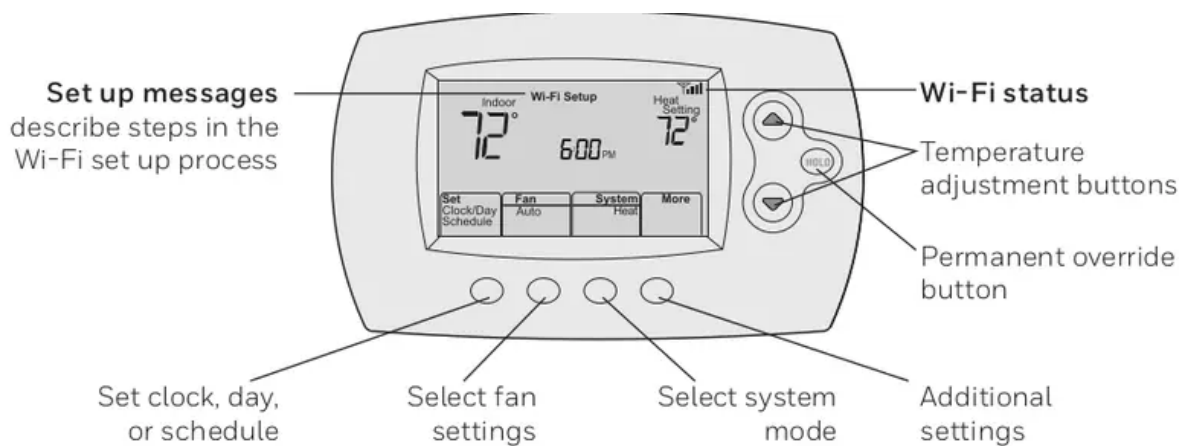

Once your thermostat is installed, it will display the home screen. Portions of this display will change depending on how you are viewing it.



The screen lights when you press any button. It stays lit for 8 seconds after you complete changes.

Preset energy-saving schedules

This thermostat is pre-set with energy-saving program settings for four time periods. Using the default settings can reduce your heating/cooling expenses if used as directed. Savings may vary depending on geographic region and usage. To change the settings, see pages 15.

		Default Heat Settings	Default Cool Settings
	WAKE 6:00 am	70°	78°
	LEAVE 8:00 am	62°	85°
	RETURN 6:00 pm	70°	78°
	SLEEP 10:00 pm	62°	82°

Setting up your thermostat

Setting up your programmable thermostat is easy. It is preprogrammed and ready to go as soon as it is installed and registered.

- + Install your thermostat.
- + Connect your home Wi-Fi network.
- + Register online for remote access.

Installing your thermostat

You might need the following tools to install this thermostat:

- No. 2 Phillips screwdriver
- Small pocket screwdriver
- Pencil
- Level (optional)
- Drill and bits (3/16" for drywall. 7/32" for plaster) (optional)
- Hammer (optional)
- Electrical tape (optional)

1. Switch OFF power to your heating/cooling system.

Important! To protect your equipment. switch OFF the power to your heating/cooling system at the breaker box or the system switch.

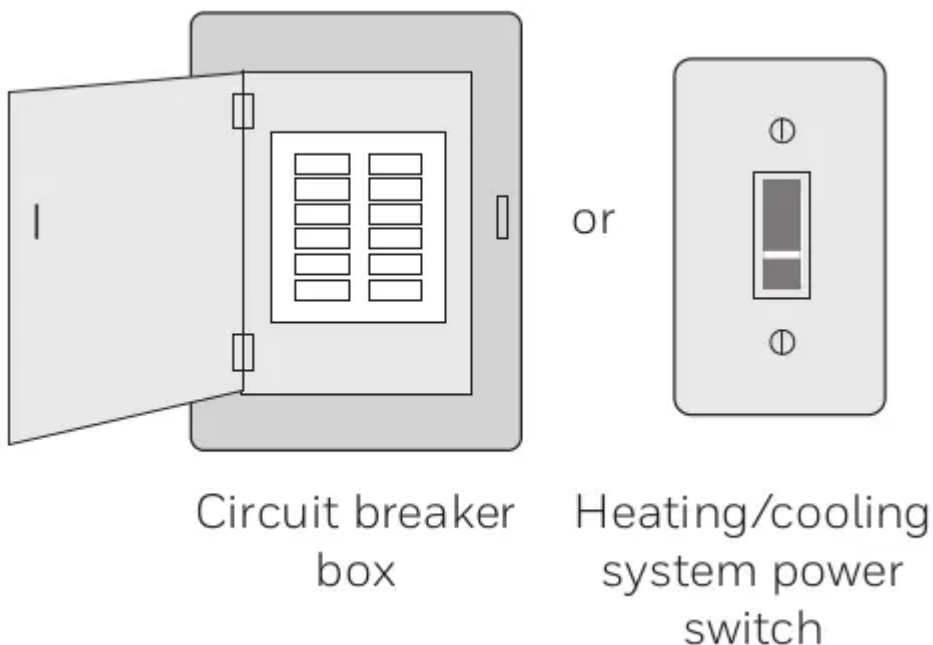

2. Remove old thermostat faceplate and leave wires connected.

- Take a picture of the wire connections for later reference.
- If no wire is connected to a "terminal labeled C or no C terminal exists on the old thermostat. view the Alternate Wiring videos at honeywellhome.com/wifi-thermostat

Important! C wire is required and is the primary power source for your thermostat. Without a C wire. your thermostat will not power up.

3. Label wires.

Do not label by wire color. Use the supplied sticky tags to label each wire as you disconnect it.

Label wires according to the old thermostat terminal designations, not by wire color.

Note: If no tag matches a wire terminal label, write the terminal label on a blank tag.

4. Remove wallplate.

Remove the old wallplate from the wall after all wires have been labeled and disconnected.

5. Separate thermostat and its wallplate.

On your new thermostat, grasp the finger holds on the top and bottom of the wallplate with one hand and the thermostat (front) with the other hand. Pull pieces apart.

If you have an older thermostat with a sealed mercury tube, turn to page ii for proper disposal instructions.

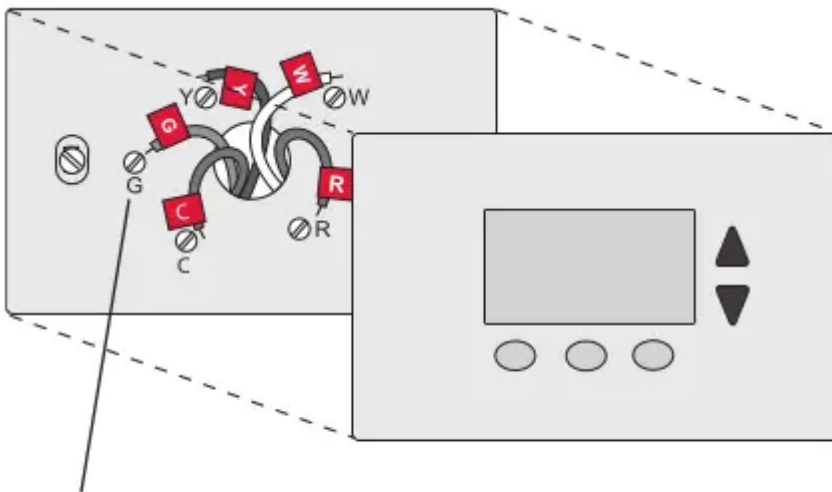

Terminal designation

Wiring Labels		Étiquettes de fils		Rótulos para los cables					
Apply these wiring labels to each wire with the appropriate terminal designation as you remove it from the existing thermostat.		Lorsque vous retirez les fils des bornes du thermostat existant, collez ces étiquettes sur chaque fil correspondant à la lettre de la borne.		Coloque estos rótulos, con la designación de las terminales, en cada cable al remover los cables del termostato actual.					
B	B	Y2	Y2	C	C	E	E	F	F
G	G	H	H	L	L	O	O	P	P
R	R	RC	RC	RH	RH	T	T	U	U
V/R	V/R	W	W	W1	W1	W2	W2	W3	W3
X	X	X1	X1	X2	X2	Y	Y	Y1	Y1
AUX	AUX								

Sticky tags

Blank sticky tags



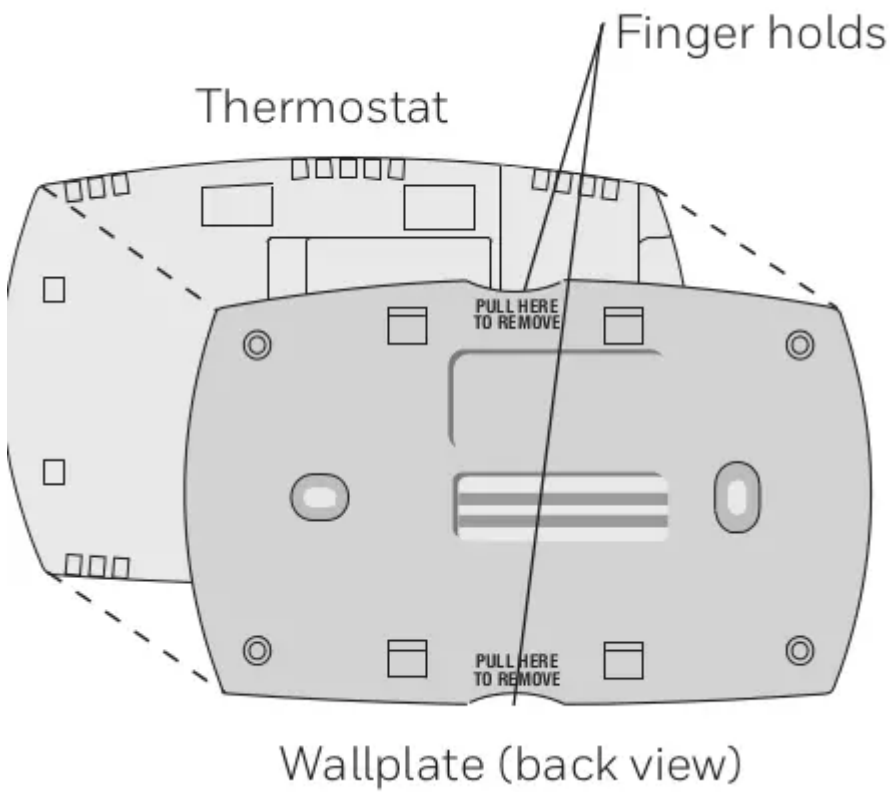
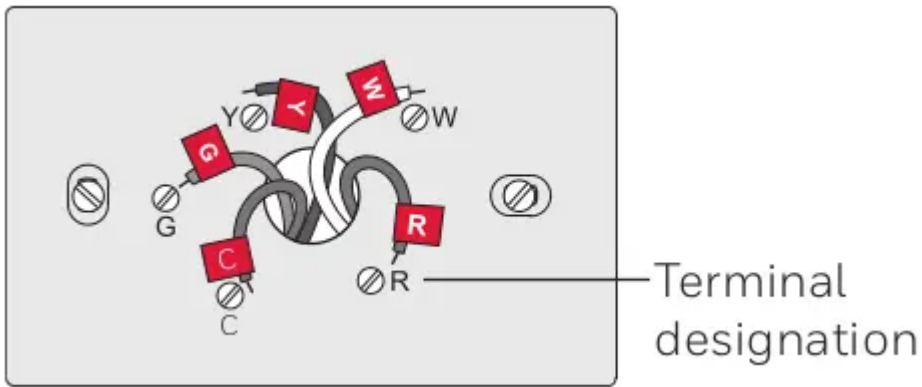

6. Mount wallplate for thermostat.

Mount your new wallplate using screws any anchors included with the thermostat. &

If necessary:

- Drill 3/16-in holes for drywall.
- Drill 7/32-in holes for plaster.

Note: You may be able to use your existing wall anchors. Hold the wallplate up to the existing anchors to check for alignment.

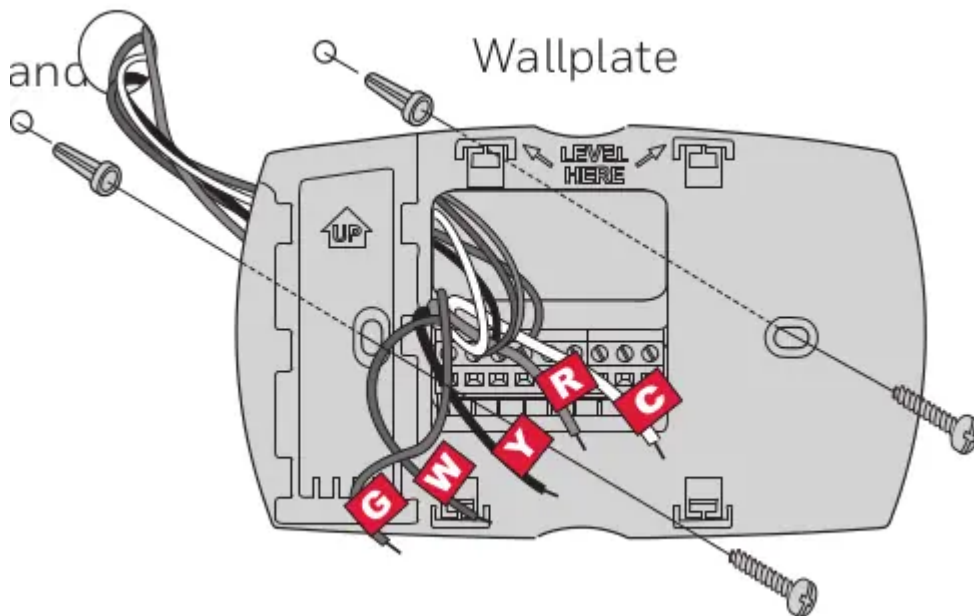

Important! The thermostat requires a C wire to operate. The C, or common, wire brings 24 VAC power to the thermostat. Many older mechanical or battery operated thermostats do not require a C wire. If you don't have a C wire, try:

+ Looking for an unused wire that is pushed into the wall. Connect that wire to C and check that it is connected to the 24 VAC common at your heating/cooling system.

Note: Not all heating/cooling systems label the 24 VAC common C. Check your system manual or contact the manufacturer to find out which terminal is the 24 VAC common.

View the Alternate Wiring videos at honeywellhome.com/wifi-thermostat

Wiring

For conventional heating/cooling systems (natural gas, oil or electric furnace, air conditioner), see page 5. See "Glossary" on page 23 for further definition.

For a heat pump system, see page 7. See "Glossary" on page 23 for further definition.

Wiring (conventional system)

7A. Wire the thermostat to your conventional system.

- a. Starting with the C Wire, match the sticky tag on the wire to the terminal labels.

You must have a C wire.

- b. Loosen screw, insert wire on inside edge of terminal, then tighten screw.

- c. Verify wire is firmly secured by gently pulling on wire.

- d. Repeat steps a-c for all other wires.

- e. Push any excess wire back into the wall opening after all wires are installed.

- f. Continue to page 8.

Labels don't match? See alternate wiring key on pages 6.

Note: The wiring for your application might be different from the wiring shown above.

Remove metal jumper
only if you have both **R**
and **RC** wires

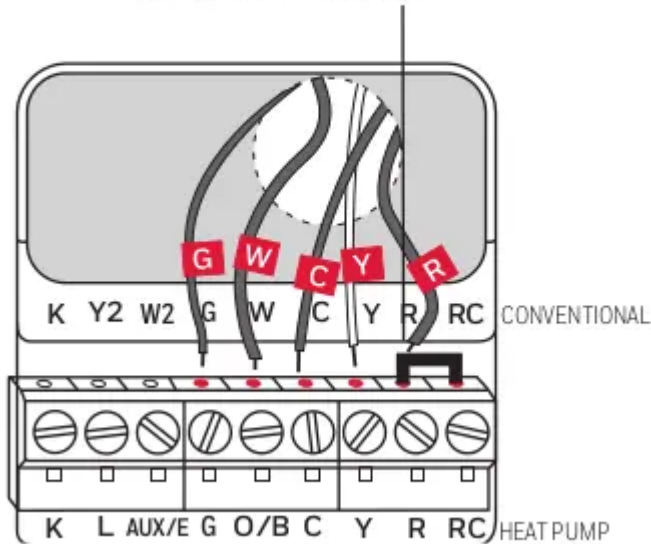

Wiring (heat pump system only)

Labels don't match? See alternate wiring key on pages 7.

7B Wire thermostat to your heat pump.

a. starting with the C Wire. match the sticky tag on the wire to the terminal labels.

You must have a C wire.

b. Loosen screw. insert wire on inside edge of terminal. then tighten screw.

c. Verify wire is firmly secured by gently pulling on wire.

d. Repeat steps a—c for all other wires.

e. Push any excess wire back into the wall opening after all wires are installed.

f. Continue to page 8.

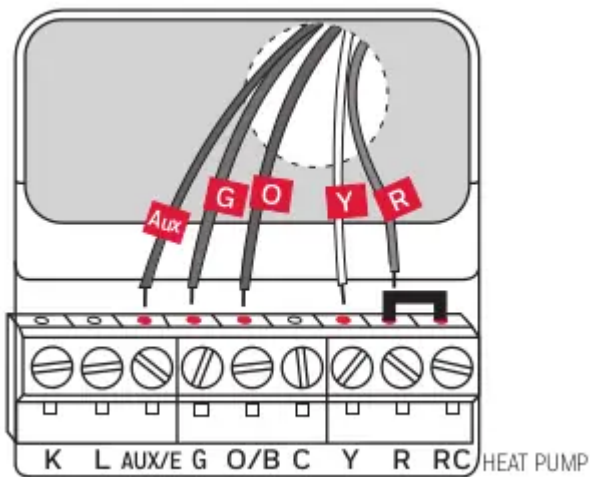

Note: The wiring for your application might be different from the wiring shown above.

Note: If old thermostat has separate wires on AUX and E. place both wires into the E/AUX terminal.

If old thermostat has wire on AUX with a jumper to E. place wire on E/AUX terminal. No jumper is required.

Alternate wiring (conventional system)

Use this if your wire labels don't match the terminal labels.

Note: You must have a C wire or equivalent.

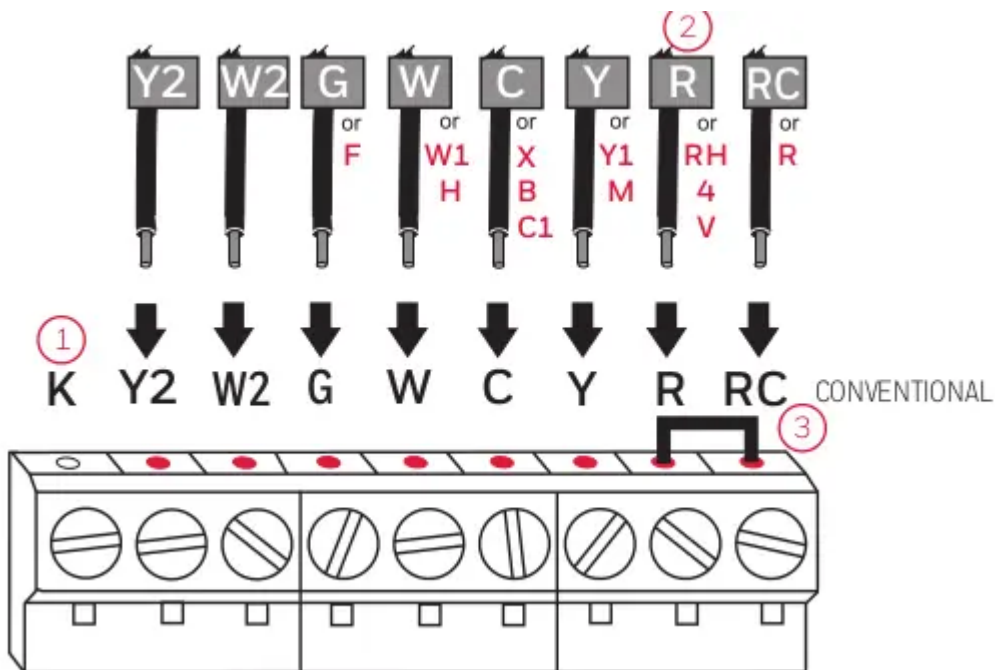

Alternate wiring key (conventional system)

+ Do not use K terminal. For future use.

+ If your old thermostat had both R and RH wires. remove metal jumper. Connect the R wire to the RC terminal. and the RH wire to the R terminal.

+ Remove metal jumper connecting R and RC only if you must connect both R and RC.

Alternate wiring (heat pump system only)

Use this if your wire labels don't match the terminal labels.

Note: You must have a C wire or equivalent. See page 6.

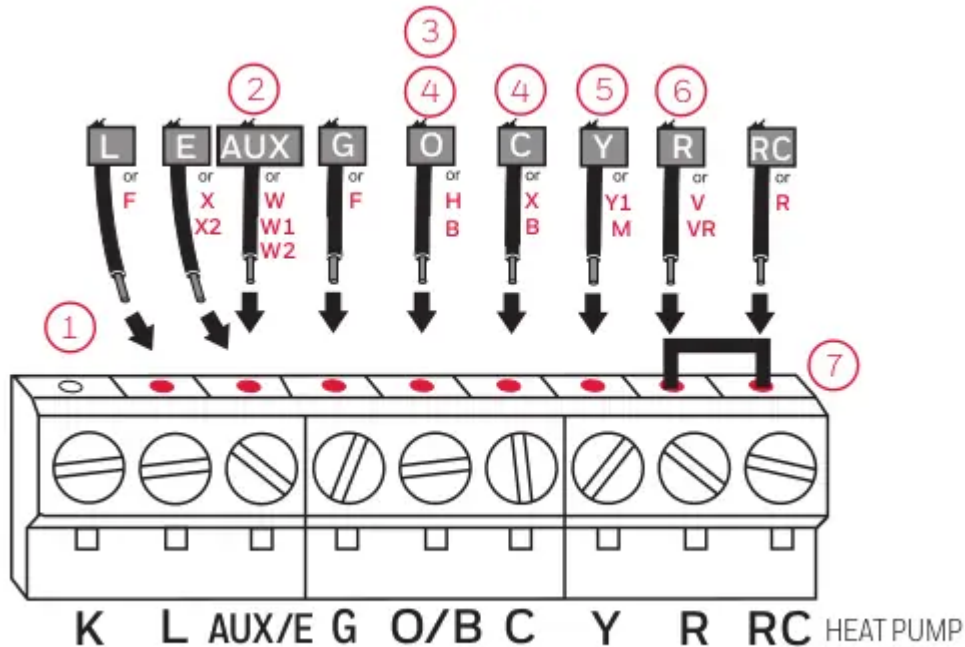

Alternate wiring key (heat pump system only)

- + Do not use K terminal. For future use.
- + If old thermostat has separate wires on AUX and E. place both wires into the E/AUX terminal. If old thermostat has wire on AUX with a jumper to E. place wire on E/AUX terminal. No jumper is required.
- + If your old thermostat had an O wire and not a B wire. attach the O wire to the O/B terminal.
- + If your old thermostat had separate O and B wires. attach the B wire to the C terminal. If another wire is attached to the C terminal. check honeywellhome.com for help. Attach the O wire to the O/B terminal.
- + If your old thermostat had separate Y1. 1 and W2 wires. check honeywellhome.com for help.
- + If your old thermostat had both V and VR wires. check honeywellhome.com for help.
- + Leave metal jumper between R and RC terminals in place.

8. Insert quick reference card.

Fold quick reference card along score lines. and slide it into the slot on the back of the thermostat.

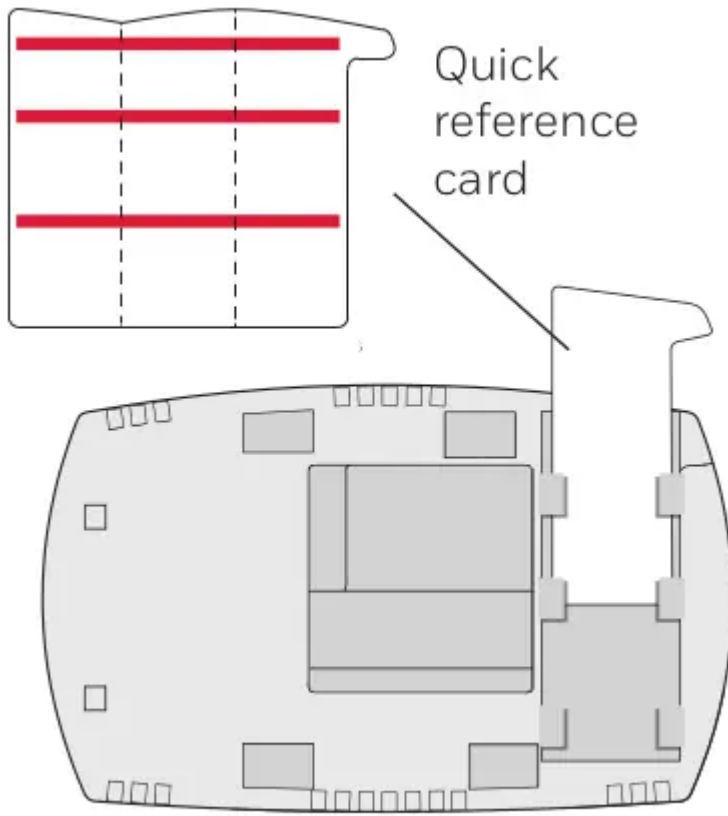

Quick reference card

Back of thermostat

9. Attach thermostat to wallplate.

Align the thermostat to the wallplate and then snap into place.

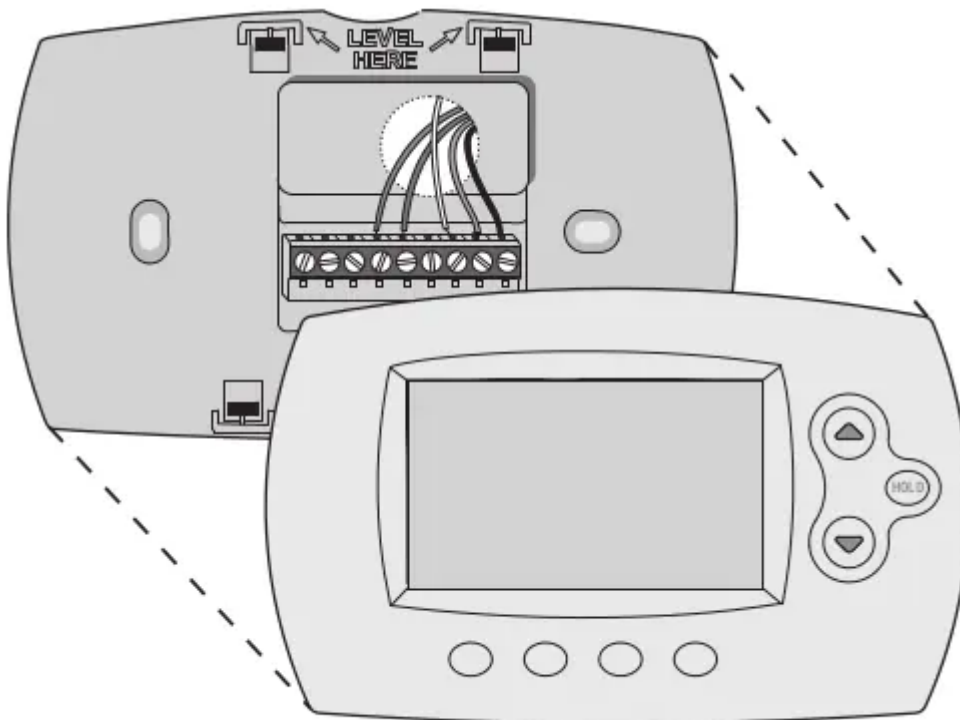

10. Switch heating/cooling system ON.

Important!

10a. Verify that the C wire is connected at the thermostat and at the heating/cooling system.

10b. Make sure the heating/ cooling system door is firmly secured.

10c. Switch power back ON for your heating/cooling system at the breaker box or its power switch.

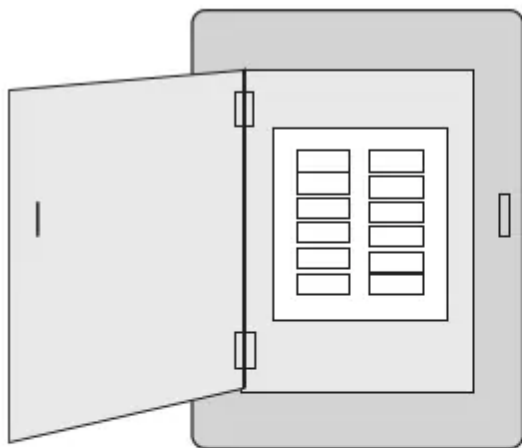

Circuit
breaker box

or

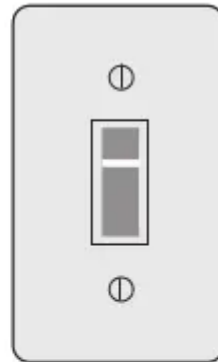

Heating/
cooling
system power
switch

11 Set clock to current day and time.

- Press ▲ or ▼ to set clock.
- Press Set Day.
- Press ▲ or ▼ to select the day of week.

Press Done to save. (Press and hold a ▲ ▼ button to quickly change a setting.)

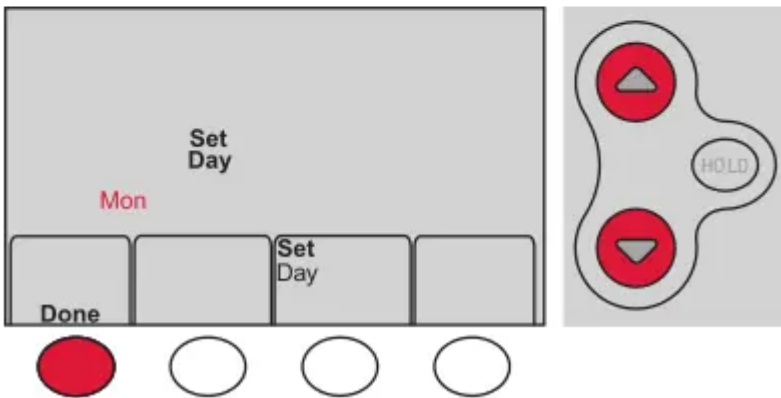
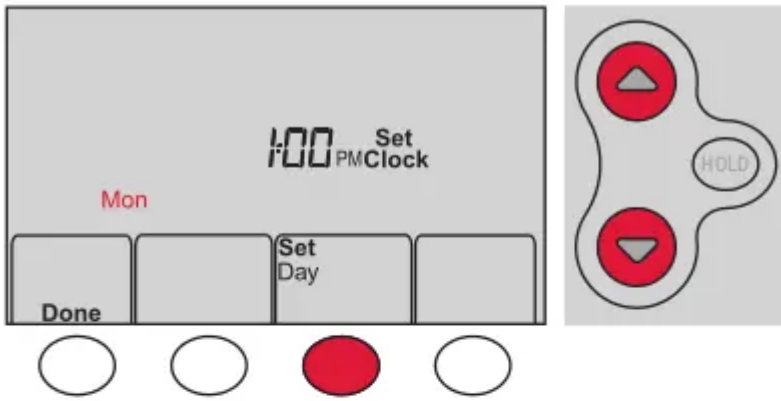

12. Determine your heating/cooling system type.

Important! Heating/cooling system type must be set so that your thermostat operates properly and does not damage your system.

- a. If your system type is conventional single stage (natural gas-powered single stage with a/c), continue to “Connecting to your Wi-Fi network” on page 10.
- b. If your system is:
 - Conventional multistage heat and cool
 - Any type of heat pump
 - Hydronic
 - Other

If you are not sure of your heating/cooling system type or have other questions, go to honeywellhome.com/support

You **MUST** change the system type by setting system function 1. See page 18 to match your thermostat to your system type.

Congratulations! Your thermostat is operational.

13. Test your thermostat

- a. Press the System button to change to heating or cooling and begin operation.
- b. For remote access to your thermostat. continue to “Connecting to your Wi-Fi network” on page 10.

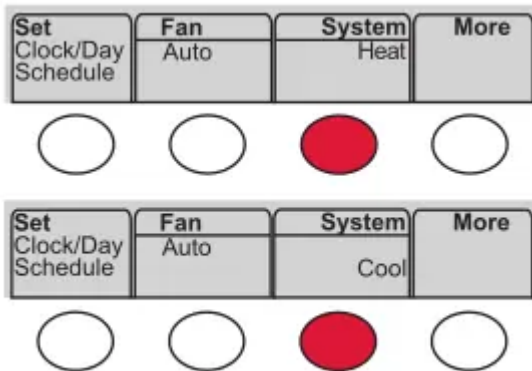

Connecting to your Wi-Fi network

To complete this process. you must have a wireless device connected to your home wireless network. Any of these device types will work:

- + Tablet (recommended)
- + Laptop (recommended)
- + Smartphone

If you get stuck at any point in this procedure. restart the thermostat by removing the thermostat from the wallplate. wait for 10 seconds. and snap it back onto the wallplate. Go to Step 1 in this procedure.

View the Wi-Fi Enrollment video at honeywellhome.com/wifi-thermostat

1. Connect to your thermostat.

- a. Make sure the thermostat displays Wi-Fi Setup.
- b. On the wireless device (laptop. tablet. smartphone). view the list of available Wi-Fi networks. ic Connect to the network called **NewThermostat_123456** (the number will vary).

Note: If you are asked to specify a home. public. or office network. select Home Network.

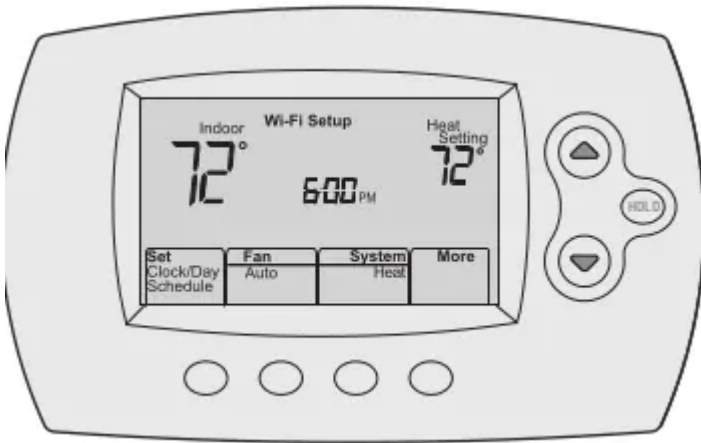

2. Join your home network.

- a. Open your web browser to access the Thermostat Wi-Fi Setup page. The browser should automatically direct you to the correct page; if it does not, go to <http://192.168.1.1>
- b. Find the name of your home network on this page and select it.

Note: Some routers have enhanced features such as guest networks; use your home network.

- c. Complete the instructions for joining your Wi-Fi network and click on the Connect button. (Depending on your network setup, you may see an instruction such as Enter Password for your home network.)

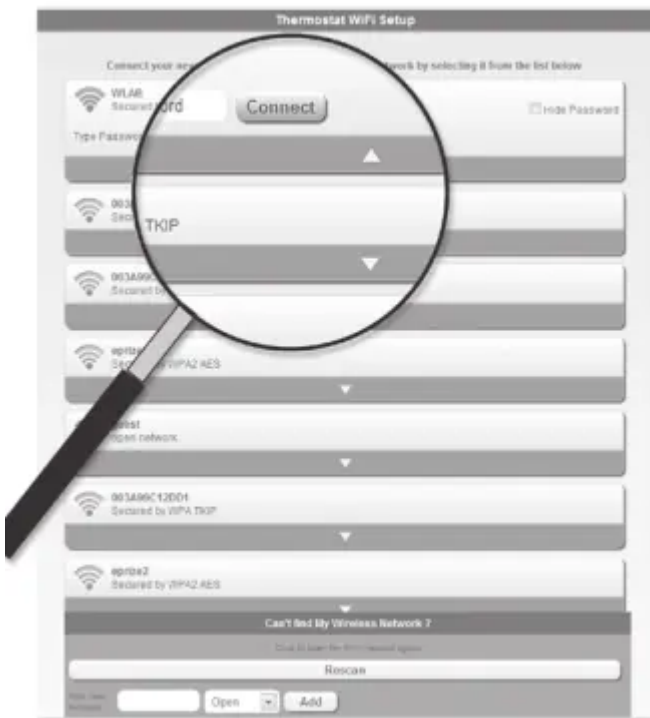

Note: If you did not correctly connect to the thermostat, you may see your home router page. If so, return to Step 1.

Note: If your Wi-Fi network does not appear in the list on the Thermostat Wi-Fi Setup page:

- + Try performing a network rescan by pressing the Rescan button. This is helpful in areas with a lot of networks.
- + If you are connecting to a hidden network. then enter the network SSID in the textbox. select the encryption type from the drop down menu. and click on the Add button. This manually adds the network to the top of the list. Click on the new network in the list and enter the password if necessary. Click on Connect to join the network.

3. Make sure your thermostat is connected.

While the connection is in process. your thermostat will flash Wait for up to 3 minutes. When the connection is complete. the display will show Wi-Fi Setup Connection Success. The Wi-Fi signal strength will appear in the top-right corner.

After about 60 seconds. the home screen will appear and Register at Total Connect will flash until registration is complete.

If you don't see these messages. see page 10.

To register online for remote access to your thermostat continue on page 12.

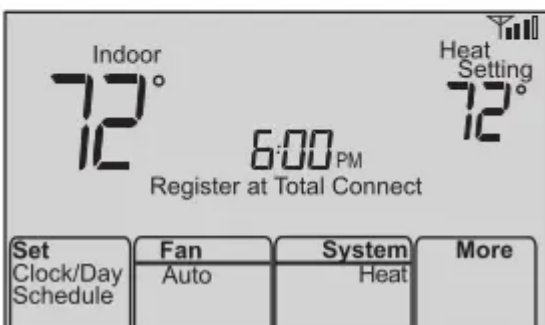

Note: If the thermostat displays Connection Failure or continues to display Wi-Fi Setup. confirm you correctly entered your home network password in step 2.

Registering your thermostat online

To view and set your thermostat remotely. you must have a Total Connect Comfort account. Use the following steps.

1. Open the Total Connect Comfort web site.



Go to mytotalconnectcomfort.com .

2. Login or create an account.

If you have an account. click Login or click Create An Account.

- a. Follow the instructions on the screen.
- b. Check your email for an activation message from My Total Connect Comfort. This may take several minutes.

Note: If you do not receive a response. check your junk mailbox or use an alternate e-mail address.

- c. Follow activation instructions in the email.
- d. Log in.

3. Register your thermostat.

After you are logged in to your Total Connect Comfort account. register your thermostat.

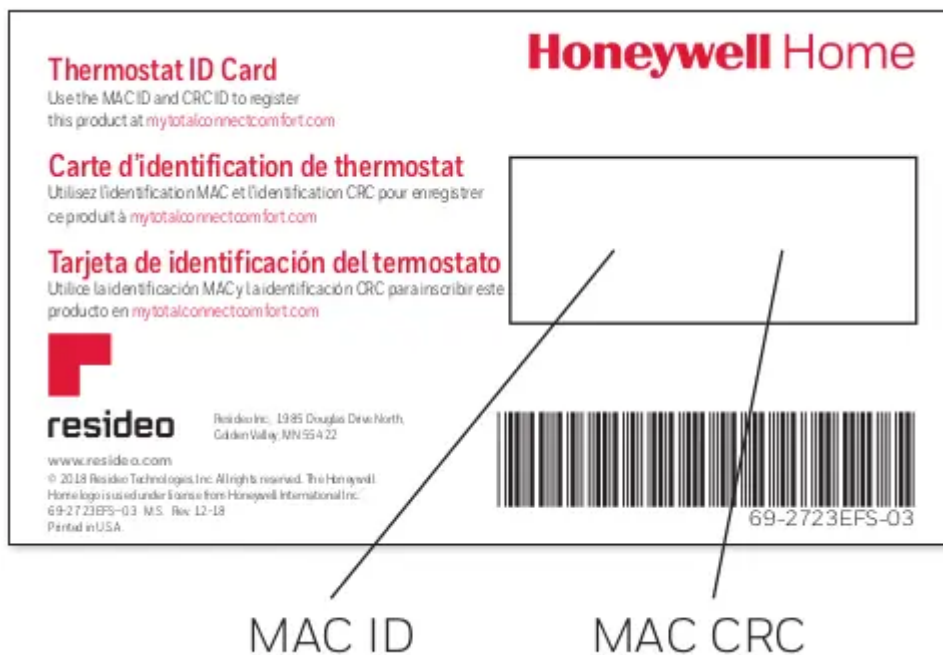

a. Follow the instructions on the screen. After adding your thermostat location. you must enter the thermostat's unique identifiers:

+ MACID

+ MAC CRC

Note: These IDs are listed on the Thermostat ID Card included in the thermostat package. The IDs are not case sensitive.

b. When the thermostat is successfully registered. the Total Connect Comfort registration screen will display a SUCCESS message.

In the thermostat display. you will see Setup Complete for about 90 seconds.

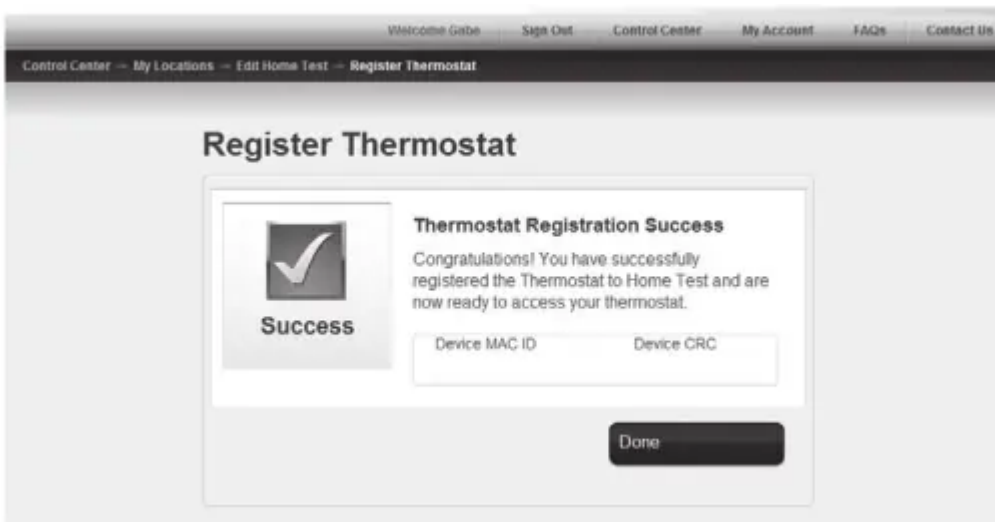

c. Also notice that your thermostat displays its signal strength.

Congratulations! You're done.

You can now control your thermostat from anywhere through your tablet, laptop, or smartphone. Total Connect Comfort free app is available for Apple iPhone, iPad, and iPod touch devices at [iTunes](#) or at [Google Play](#) for all Android devices.

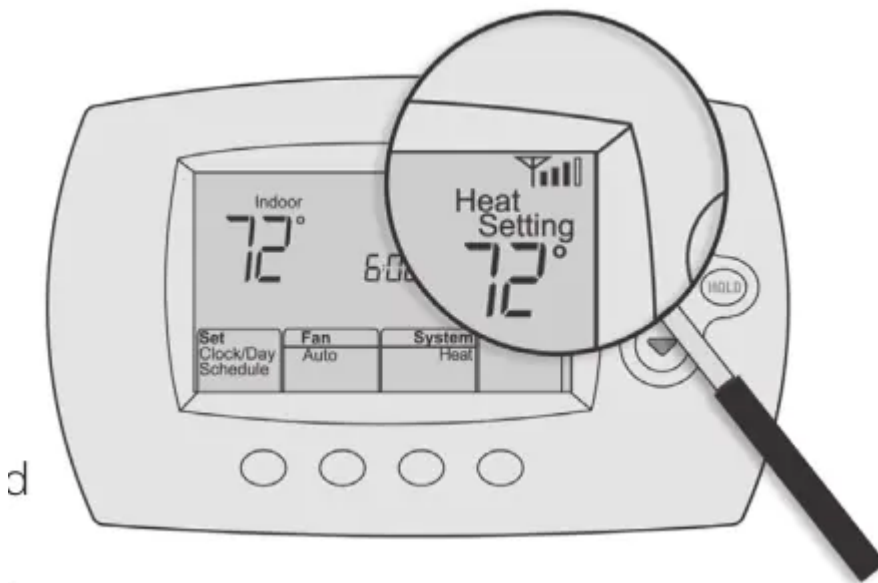

Setting the time and day

Setting the time and day

1. Press Set Clock/Day/Schedule, then press ▲ or ▼ to set clock.
2. Press Set Day, then press ▲ or ▼ to select the day of week.
3. Press Done to save.

Note: If the Set Clock/Day/Schedule option is not displayed, press Done.

Note: If the display flashes Set Clock, the thermostat will follow your settings for the Monday "Wake" time period until you reset the time and day.

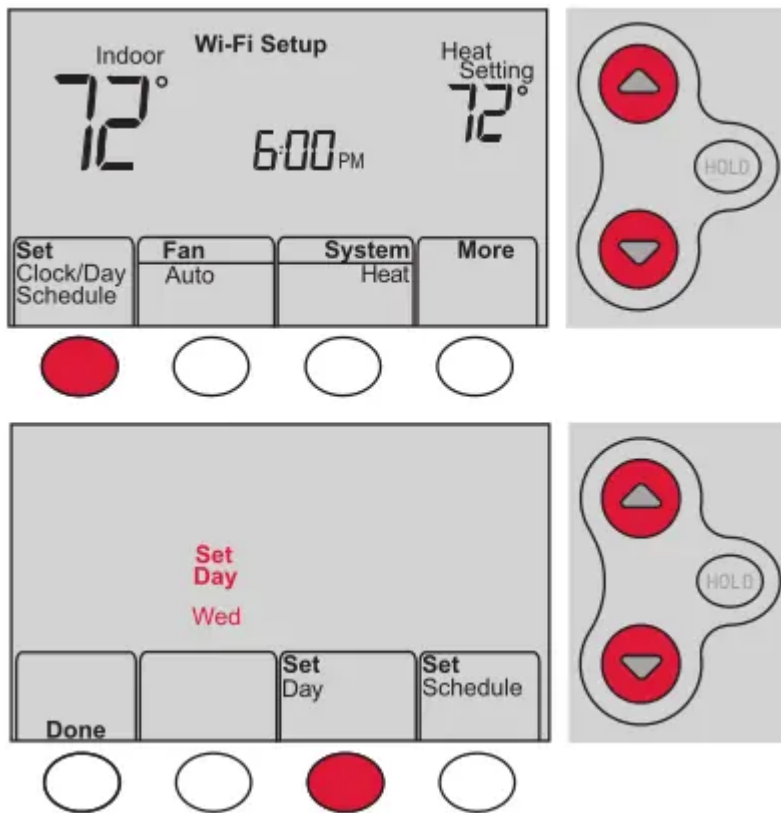

Setting the fan

Press Fan to select On or Auto (toggle to re-select).

Auto: Fan runs only when the heating or cooling system is on. Auto is the most commonly used setting.

On: Fan is always on.

Note: Options may vary depending on your heating/cooling equipment.

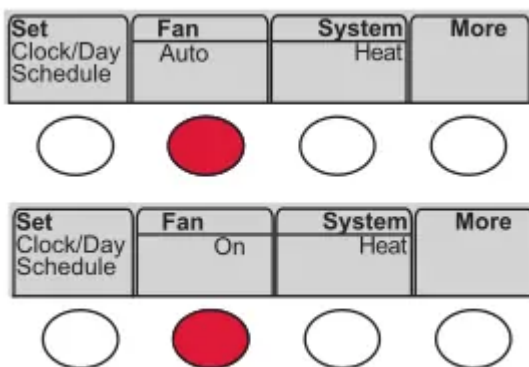

Selecting system mode



Press System to select:

Heat: Controls only the heating system.

Cool: Controls only the cooling system.

Off: Heating/cooling systems are off.

Auto: Selects heating or cooling depending on the indoor temperature.

Em Heat (heat pumps with aux. heat): Controls auxiliary/emergency heat. Compressor is off.

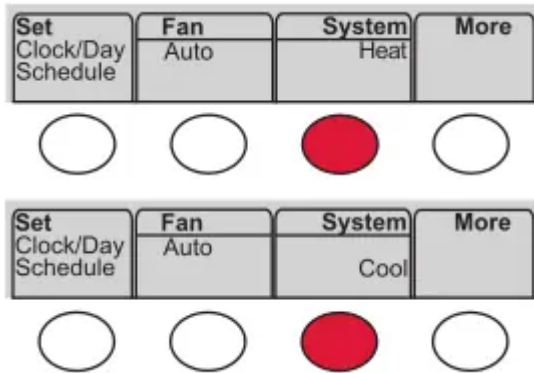



Note: Depending on how your thermostat was installed, you may not see all system settings.

Adjusting program schedules

1 Press Set Clock/Day/Schedule, then Set Schedule.

2 Press  or  to set your Monday (Mon) Wake time, then press Next.

3 Press  or  to set the temperature for this period, then press Next.

4 Set time and temperature for the next time period (Leave). Repeat Steps 2 and 3 for each time period.

5 Press Next to set time periods for the next day. Repeat Steps 2 through 4 for each day.

6 Press Done to save and exit.

Note: Make sure the thermostat is set to the system mode you want to program (Heat or Cool).

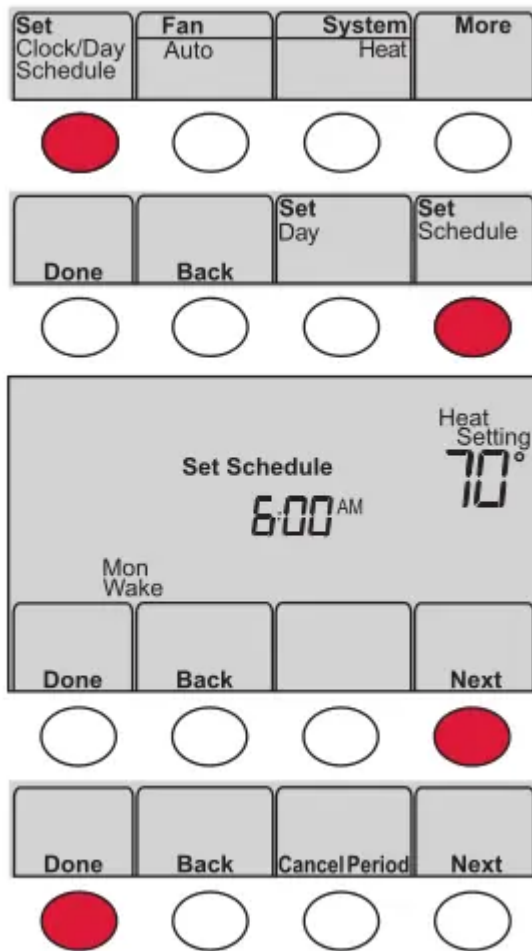

Overriding schedules temporarily

Press ▲ or ▼ to immediately adjust the temperature.

The new temperature will be maintained only until the next programmed time period begins.

To cancel the temporary setting at any time, press Cancel. The program schedule will resume.

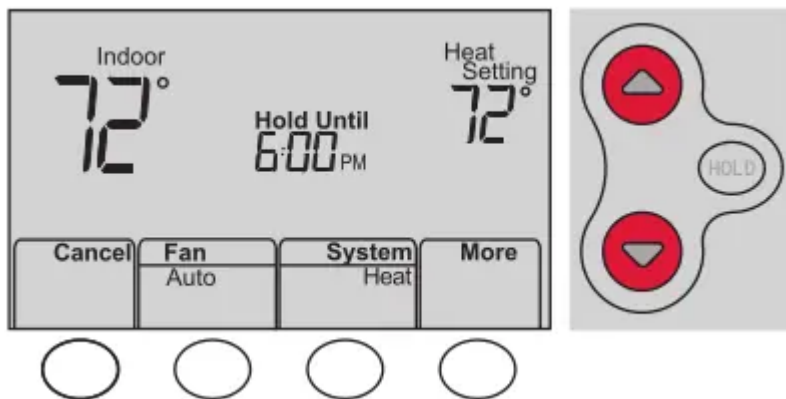

Overriding schedules permanently

1 Press HOLD to permanently adjust the temperature. This will turn off the program schedule.

2 Press ▲ or ▼ to adjust the temperature setting. The temperature you set will be maintained 24 hours a day until you manually change it or press Cancel to resume the program schedule

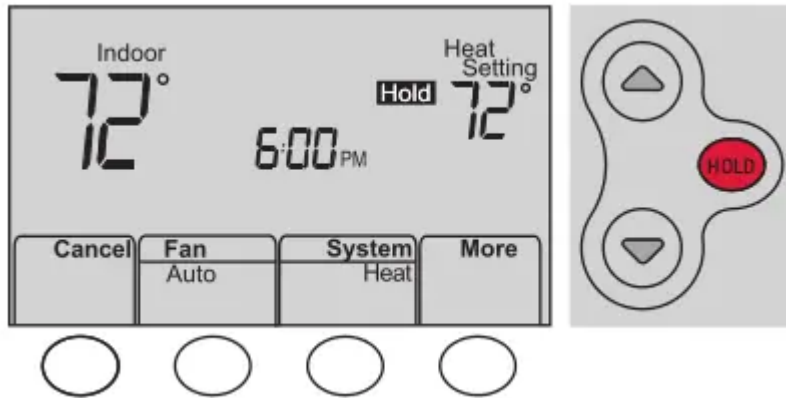

Unregistering thermostat

If you remove the thermostat from your Total Connect Comfort website account (for example, you're moving and leaving the thermostat behind), the thermostat will display Register at Total Connect until it is re-registered.

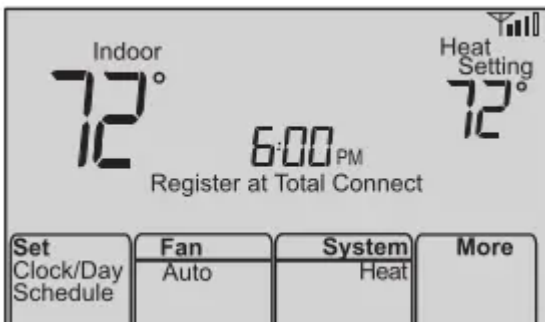

Disconnecting Wi-Fi

Replacing your router

If you disconnect the thermostat from your Wi-Fi network:

- 1 Enter system setup (see page 18).
- 2 Change setting 39 to O (see page 19). The screen will display Wi-Fi Setup.

Re-connect to a Wi-Fi network by following the steps on page 10.



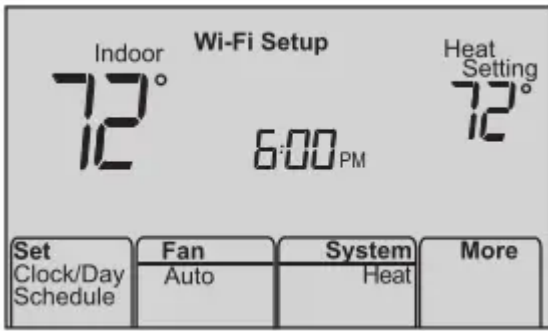

Turning Wi-Fi off

If you do not plan to control the thermostat remotely, you can remove the Wi-Fi Setup message from the screen:

1 Enter system setup (see page 18).

2 Change setting 38 to 0 (see page 19). Wi-Fi Setup will be removed from the screen. If you want to connect to the Wi-Fi network later, change setting 38 back to 1.

Software updates

Honeywell periodically issues updates to the software for this thermostat. The updates occur automatically through your Wi-Fi connection. All your settings are saved, so you will not need to make any changes after the update occurs.

While the update is taking place, your thermostat screen flashes Updating and shows the percentage of the update that has occurred. When the update is complete, your home screen will appear as usual.

Note: If you are not connected to Wi-Fi, you will not get automatic updates.

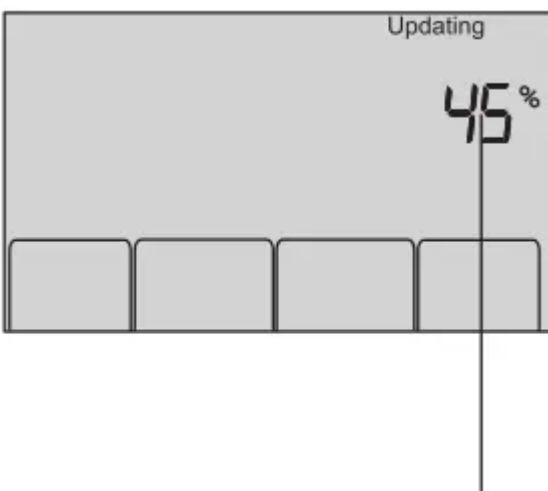

Percentage of update complete

Smart Response Technology

This feature allows the thermostat to “learn” how long the heating/cooling system takes to reach programmed temperature settings. so the temperature is reached at the time you set.

For example: Set the Wake time to 6:00 am. and the temperature to 70 °F (21 °C). The heat will come on before 6:00 am. so the temperature is 70 °F (21 °C) by 6:00 am.

Note: System setting function 13 controls Smart Response Technology. See “Smart Response Technology” on page 19.

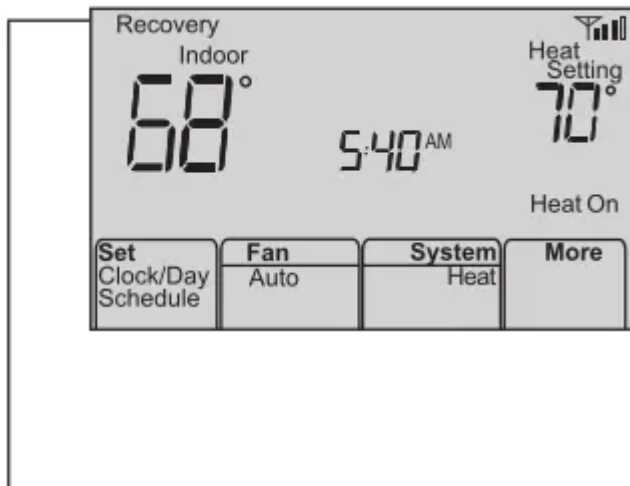

The message **Recovery** is displayed when the system is activated before a scheduled time period.

Compressor protection

This feature forces the compressor to wait a few minutes before restarting. to prevent equipment damage.

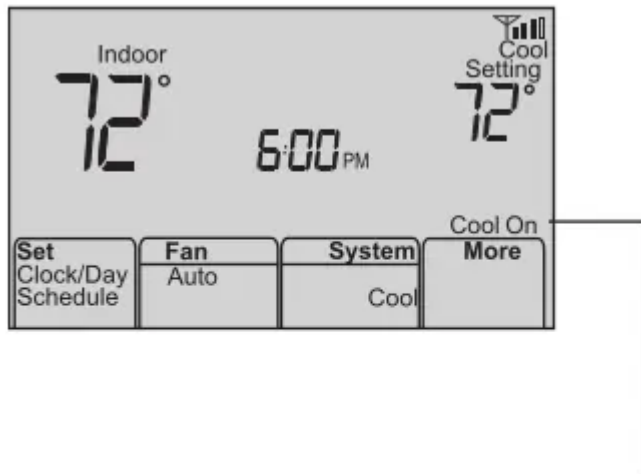

The message **Cool On** (or **Heat On** for a heat pump) will flash during the wait time.

Auto changeover

This feature is used in climates where both air conditioning and heating are used on the same day. When the system is set to Auto, the thermostat automatically selects heating or cooling depending on the indoor temperature.

Heat and cool settings must be at least 3 °F (1.7 °C) apart. The thermostat will automatically adjust settings to maintain this 3 °F (1.7 °C) separation.

Note: System setting function 12 controls Auto changeover. See “Manual/Auto Changeover” on page 19.

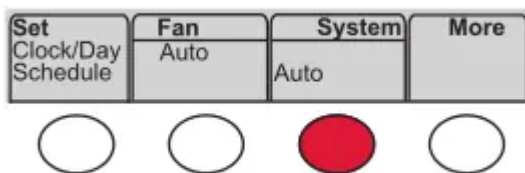

Setting functions and options

You can change options for a number of system functions. Available functions depend on the type of system you have. The functions, along with available options, are described on pages 18-19.

This thermostat is pre-set for a single-stage heating/cooling system. Setting function 1 for a heat pump will adjust the default settings.

Press Fan and A simultaneously and hold for approximately 3 seconds. The screen will change to display two numbers and the button designations will be Done. Back. blank. Next.

Press Next until you see the function number—the larger number on the left— you want to set.

Change options for any function by pressing A or W until the correct option (smaller number on right) is displayed.

Repeat Steps 2 and 3 until you have set all functions that you wish to change.

When you have made all changes. press Done to save and exit.

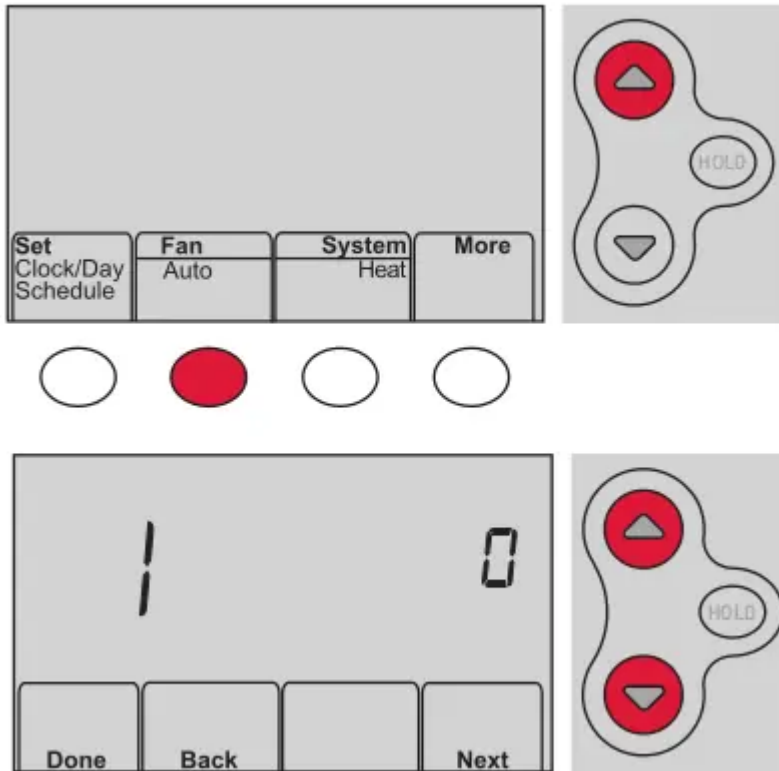

System setup

1 If you are not sure of your heating/ cooling system type or have other questions. go to honeywellhome.com

- 0 Heat/cool: Gas. oil or electric heating with central air conditioning.
- 1 Heat pump: Heat pump without backup or auxiliary heat.
- 2 Heat only: Gas. oil or hot water heat without central air conditioning
- 3 Heat only with fan: Gas. oil or electric heat without central air conditioning
- 4 Cool only: Central air conditioning only.
- 5 Heat pump: Heat pump with backup or auxiliary heating.
- 6 Heat/Cool Multiple stages: 2 heat stages (wires on W and W2). 2 cooling stages (wires on Y and Y2).
- 7 Heat/Cool Multiple stages: 2 heat stages (wires on W and W2). 1 cooling stage (wire on Y).
- 8 Heat/Cool Multiple stages: 1 heat stage (wires on W). 2 cooling stages (wire on Y and Y2).

2 Heat Pump Changeover Valve (for heat pumps only)

0 Cooling changeover valve: Use this setting if you connected a wire labeled “O” to the O/B terminal.

1 Heating changeover valve: Use this setting if you connected a wire labeled “B” to the O/B terminal.

3 Heating Fan Control

0 Gas or oil heat: Use this setting if you have a gas or oil heating system (system controls fan operation).

1 Electric heat: Use this setting if you have an electric heating system (thermostat controls fan operation).

Function		Settings & Options	
5	Heating Cycle Rate	5	Gas or oil furnace: Standard gas/oil furnace (less than 90% efficiency).
6	Heating Cycle Rate Stage 2	9	Electric furnace: Electric heating systems.
		3	Hot water or high-efficiency furnace: Hot water system or gas furnace (more than 90% efficiency).
		1	Gas/oil steam or gravity system: Steam or gravity heat systems.
12	Manual/Auto Changeover See page 17 for more information.	0	Manual changeover (Heat/Cool/Off).
		1	Automatic changeover (Heat/Cool/Auto/Off). Automatically turns on Heat or Cool based on room temperature. Note: System maintains minimum 3 °F (1.7 °C) difference between heat and cool settings.
13	Smart Response Technology See page 17 for more information.	1	On
		0	Off
14	Temperature Format (°F/°C)	0	Fahrenheit
		1	Celsius

[IMAGE]

13	Smart Response Technology See page 17 for more information.	1 On 0 Off
14	Temperature Format (°F/°C)	0 Fahrenheit 1 Celsius
15	Schedule Options	1 Program schedule is on (7-day programmable). 0 Program schedule is off. Thermostat can not be programmed.
36	Device Name This name will identify the thermostat when you view it remotely. If you register multiple thermostats, give each one a different name.	52 = Thermostat 1 Basement 16 Exercise Room 30 Library 44 Porch 2 Bathroom 17 Family Room 31 Living Room 45 Rec Room 3 Bathroom 1 18 Fireplace 32 Lower Level 46 Sewing Room 4 Bathroom 2 19 Foyer 33 Master Bath 47 Spa 5 Bathroom 3 20 Game Room 34 Master Bed 48 Storage Room 6 Bedroom 21 Garage 35 Media Room 49 Studio 7 Bedroom 1 22 Great Room 36 Music Room 50 Sun Room 8 Bedroom 2 23 Guest Room 37 Nursery 51 Theater 9 Bedroom 3 24 Gym 38 Office 52 Thermostat 10 Bedroom 4 25 Kid's Room 39 Office 1 53 Upper Level 11 Boat House 26 Kitchen 40 Office 2 54 Utility Room 12 Bonus Room 27 Kitchen 1 41 Pantry 55 Walk In Closet 13 Computer Room 28 Kitchen 2 42 Play Room 56 Wine Cellar 14 Den 29 Laundry Room 43 Pool Room 57 Workshop 15 Dining Room

Frequently asked questions

Q: Will my thermostat still work if I lose my Wi-Fi connection?

A: Yes. the thermostat will operate your heating and/or cooling system with or without Wi-Fi.

Q: How do I find the password to my router?

A: Contact the manufacturer of the router or check the router documentation.

Q: Why am I not seeing my Wi-Fi setup page?

A: You are probably connected only to your router. not to your thermostat. Try connecting to the thermostat again.

Q: Why isn't my thermostat connecting to my Wi-Fi router even though it is very close to the thermostat?

A: Verify that the password entered for the Wi-Fi router is correct.

Q: Where can I find my MAC ID and MAC CRC codes?

A: The MAC ID and MAC CRC numbers are included on a card packed with the thermostat or on the back of the thermostat (visible when removed from wallplate). Each thermostat has a unique MAC ID and MAC CRC.

Q: My thermostat is unable to register to the Total Connect Comfort website.

A: Verify that the thermostat is correctly enrolled on your home Wi-Fi network. The message center will display Wi-Fi Setup or Register at Total Connect. You might also see the Wi-Fi Signal strength icon. Verify that the Wi-Fi router has a good internet connection. On your computer, verify that you can open the site at mytotalconnectcomfort.com

If you cannot open the site, switch off the internet modem for a few seconds, then power it back on.

Q: I registered on the Total Connect Comfort website but was unable to login using my new account.

A: Check your email and ensure that you received an activation email. Follow the instructions to activate your account and then login to the website.

Q: I have signed up on the Total Connect Comfort website and have not received a confirmation email.

A: Check for the email in your Junk or Deleted folder.

Q: Is there a way to extend the signal strength?

A: Most standard routers can be set up to be a repeater. You can also purchase and install Wi-Fi repeater.

Troubleshooting

Lost Signal

If the no-Wi-Fi indicator displays in place of the

Wi-Fi strength indicator in the upper right hand corner of the home screen:

+ Check another device to be sure Wi-Fi is working in your home; if not, call your Internet Service Provider.

+ Move the router.

+ Restart the thermostat: remove it from the wallplate, wait 10 seconds, and snap it back onto the wallplate. Return to Step 1 of Connecting to your Wi-Fi network.

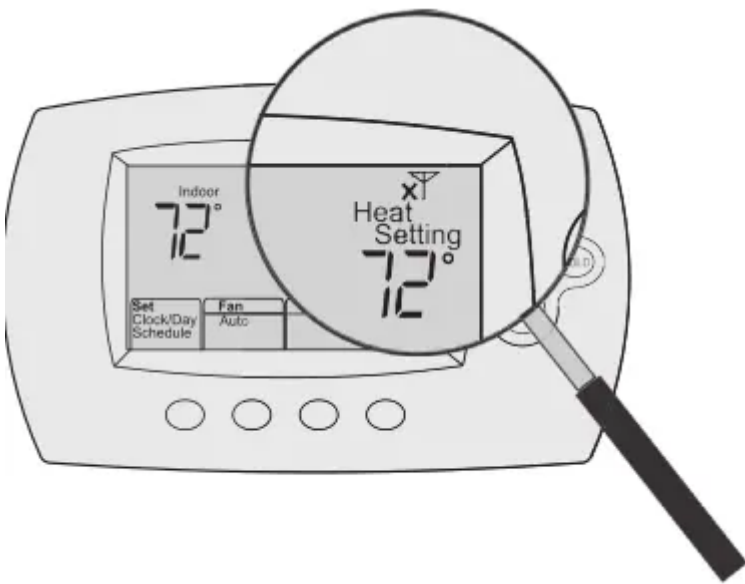

Error Codes

For certain problems, the thermostat screen will display a code that identifies the trouble. Initially, error codes are displayed alone in the time area of the screen; after a few minutes, the home screen is displayed and the code alternates with the time.

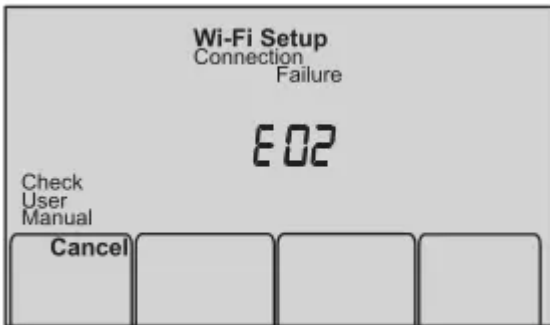

E01: During Wi-Fi Setup, the router lost power.

- + Ensure your router has power.
- + If trying to connect to a hidden or manually added network, confirm the router has power and is working.

E02: Invalid Wi-Fi password. This code displays for 30 seconds, then the thermostat will re-enter Wi-Fi Setup mode.

- + Invalid Wi-Fi password. This code displays for 30 seconds, then the thermostat will re-enter Wi-Fi Setup mode.
- + Re-enter password for your home Wi-Fi network.
- + Repeat setup process and confirm your password for your home Wi-Fi network.

E42: Router is not issuing an IP address to the thermostat.

- + Wait for 30 minutes, connection can take several minutes.
- + If still no connection, remove thermostat from wallplate for 10 seconds, then reconnect it (see page 10).
- + Verify your router is correctly setup to automatically give IP addresses.

E43: No internet connection. Thermostat cannot communicate to Total Connect Comfort.

- + Make sure the Internet cable is plugged in.
- + Reboot the router.

E99: General error

- + Remove thermostat from wallplate for 10 seconds, then reconnect it (see page 10)

If you have difficulty with your thermostat, please try the following suggestions. Most problems can be corrected quickly and easily.

Display is blank

- Check circuit breaker and reset if necessary.
- Make sure power switch at heating and cooling system is on.

- Make sure furnace door is closed securely.
- Make sure C wire is connected (see page 6).

Cannot change system setting to Cool

- Check Function 1: System Type to make sure it is set to match your heating and cooling equipment (see page 18).

Fan does not turn on when heat is required

- Check Function 3: Heating Fan Control to make sure it is set to match your heating equipment (see page 18).

Cool On or Heat On is flashing on the screen Heat pump issues cool air in heat mode. or warm air in cool mode

- Compressor protection feature is engaged. Wait 5 minutes for the system to restart safely. without damage to the compressor.
- Check Function 2: Heat Pump Changeover Valve to make sure it is properly configured for your system (see page 18).

Heating or cooling system does not respond

- Press System to set system to Heat. Make sure the temperature is set higher than the Inside temperature.
- Press System to set system to Cool. Make sure the temperature is set lower than the Inside temperature.
- Check circuit breaker and reset if necessary.
- Make sure power switch at heating & cooling system is on.
- Make sure furnace door is closed securely.
- Wait 5 minutes for the system to respond.

Heating system is running in cool mode

- Check Function 1: System Type to make sure it is set to match your heating and cooling equipment (see page 18).

Heating and cooling equipment are running at the same time

- Check Function 1: System Type to make sure it is set to match your heating and cooling equipment (see page 18).
- Grasp and pull thermostat away from wallplate. Check to make sure bare wires are not touching each other.
- Check thermostat wiring is correct.

Glossary

C wire

The “C” or common wire brings 24 VAC power to the thermostat from the heating/cooling system.

Some older mechanical or battery operated thermostats may not have this wire connection. It is necessary for establishing a Wi-Fi connection to your home network.

Heat Pump heating/cooling system

Heat pumps are used to heat and cool a home. If your old thermostat has a setting for auxiliary or emergency heat, you likely have a heat pump.

Conventional heating/cooling system

Non-heat pump type systems; these include air handlers, furnaces or boilers that run on natural gas, oil or electricity. They may or may not include an air conditioner.

Jumper

A small piece of wire that connects two terminals together.

MAC ID. MAC CRC

Alphanumeric codes that uniquely identify your thermostat.

QR Code

Quick response code. A two-dimensional, machine-readable image. Your wireless device can read the black and white pattern in the square and link its browser directly to a web site. QR Code is a registered trademark of DENSO WAVE INCORPORATED.

Electrical Ratings

<u>Terminal</u>	<u>Voltage (50 Hz/60Hz)</u>	<u>Running Current</u>
W Heating (Powerpile)	20 Vac - 30 Vac 750 mV DC	0.02 A - 1.0 A 100 mA DC
W2 (Aux/E) Heating	20 Vac - 30 Vac	0.02 A - 1.0 A
Y Cooling	20 Vac - 30 Vac	0.02 A - 1.0 A
Y2 Cooling	20 Vac - 30 Vac	0.02 A - 1.0 A
G Fan	20 Vac - 30 Vac	0.02 A - 0.5 A
O/B Changeover	20 Vac - 30 Vac	0.02 A - 0.5 A
L Output	20 Vac - 30 Vac	0.02 A - 0.5 A

Warning

This content is compiled from multiple sources and is provided for reference purposes only. It may not be complete or fully applicable to all situations. If you are unable to resolve your issue, please contact the product manufacturer or an authorized service provider for official support.

