

PRODUCT DESCRIPTION

Parts

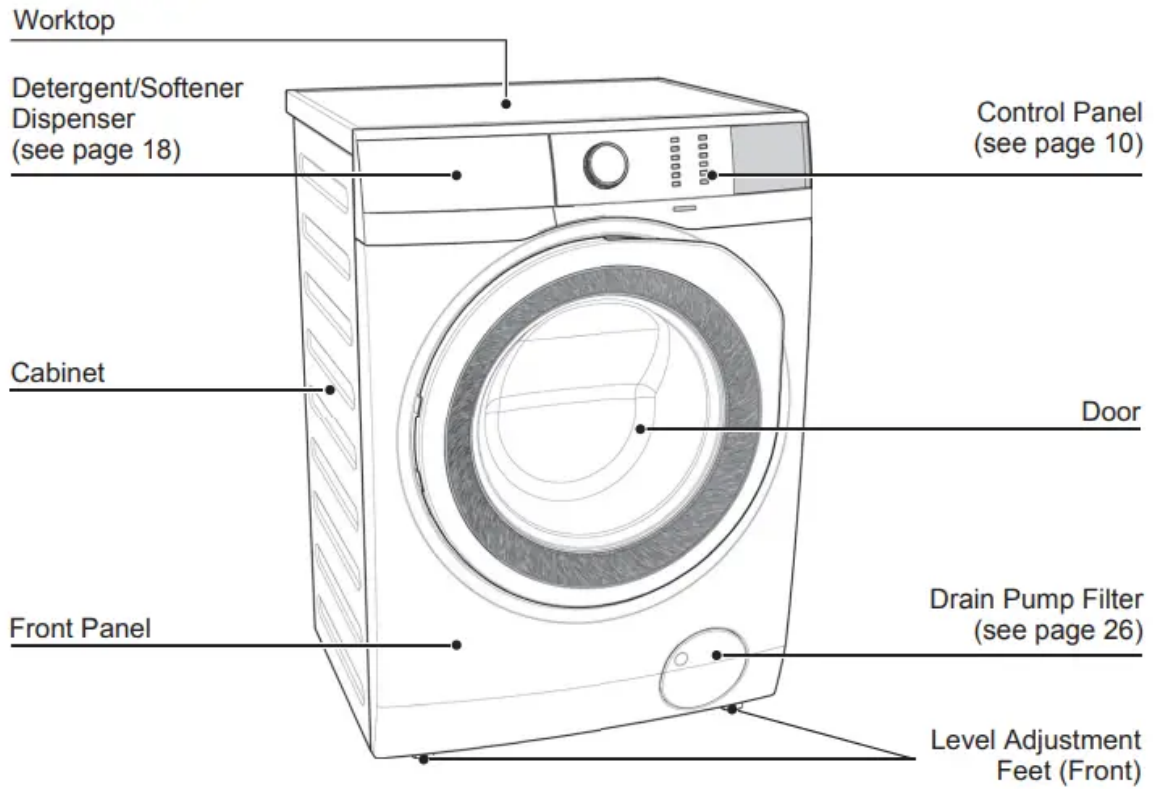

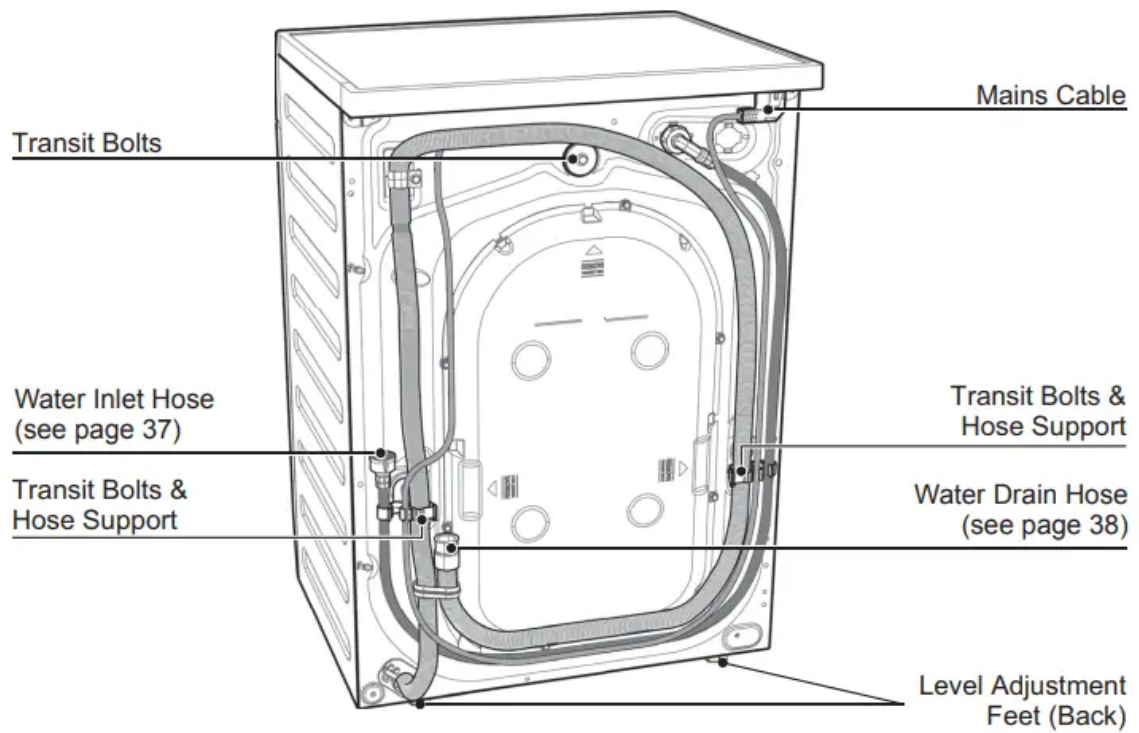

Detergent/Softener Dispenser (For more informations, see page 18, 25)

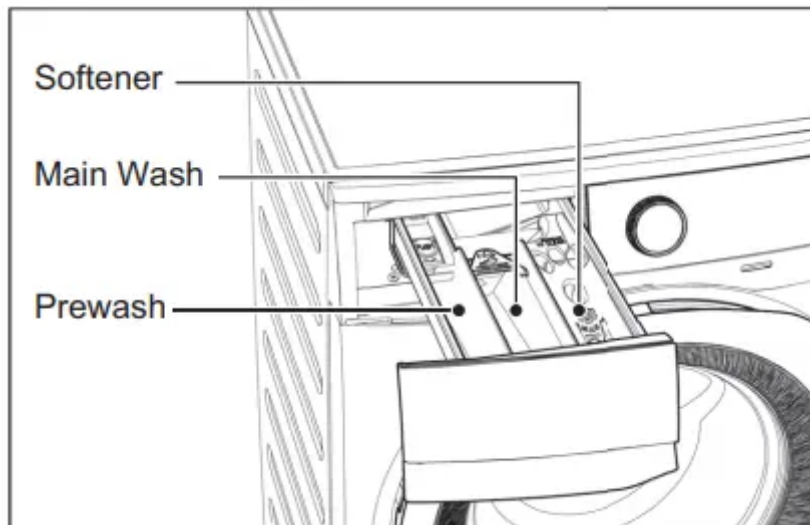

Door (when open) (for more informations, see page 18)



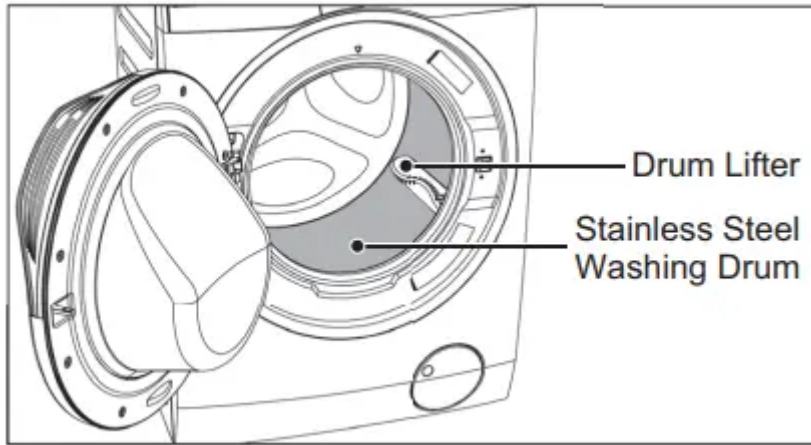

Drain Pump Filter (when open)

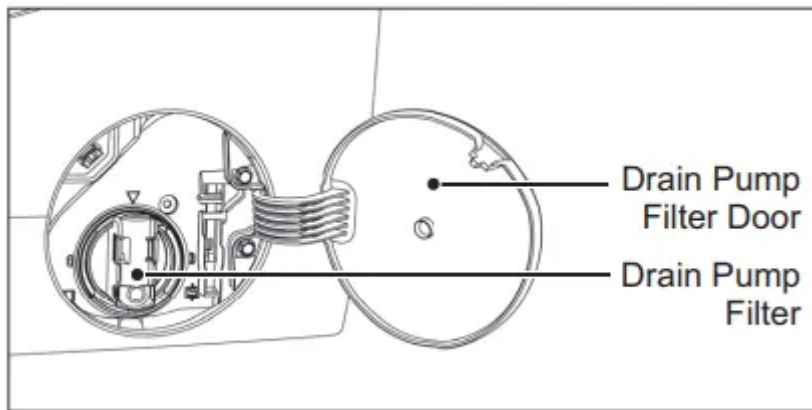

Level Adjustment Feet

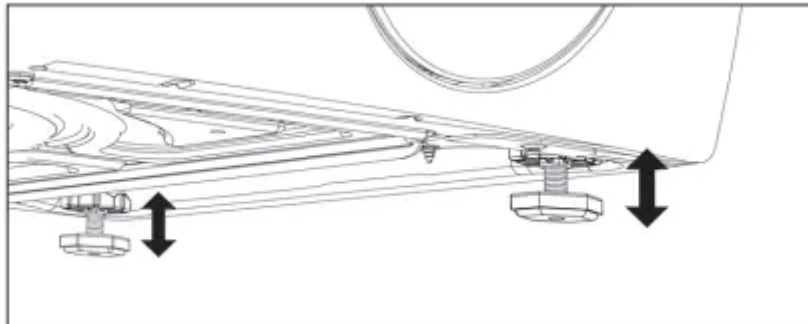

Transit Bolt (when remove)



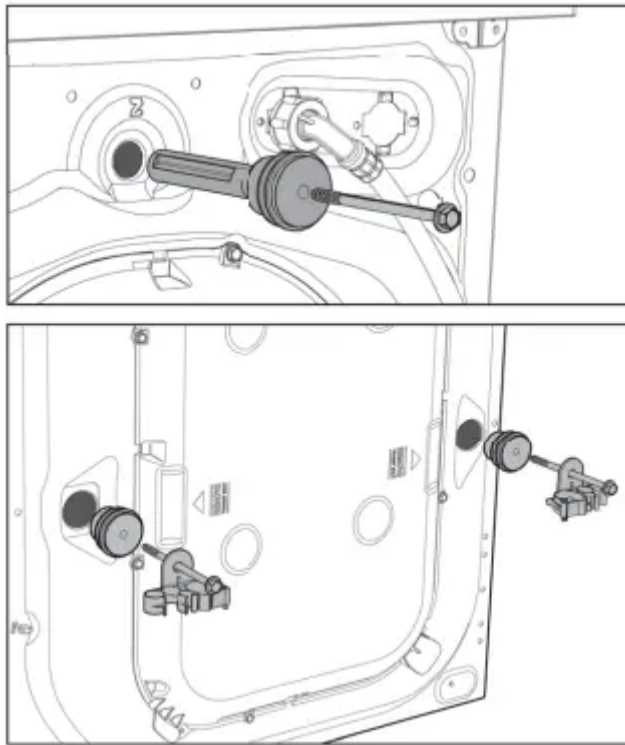

Transit bolts must be removed before using the appliance.

Accessories

Plastic Caps

To close the holes on the rear side of the cabinet after the removal of the transit bolts.



Plastic Hose Guide

To connect the drain hose on the edge of a sink.



Spanner

To remove the transit bolts.

To adjust levelling legs.



CONTROL PANEL



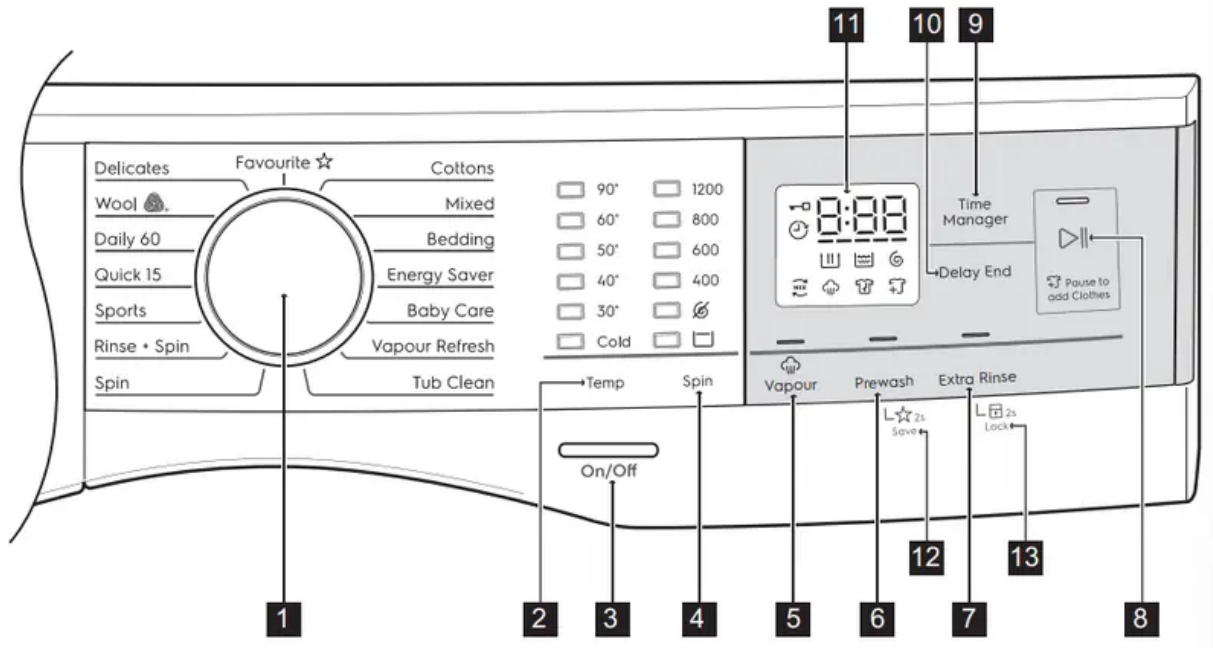



Control Panel Description

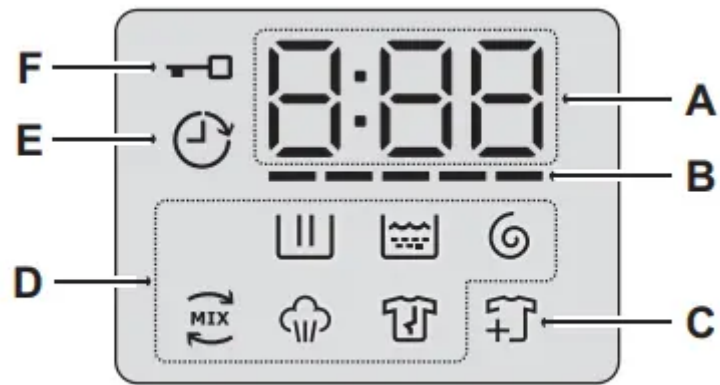

1. Program Selector Knob
2. Temperature Selection Touchpad
3. On/Off Button
4. Spin Selection Touchpad
5. Vapour Touchpad
6. Prewash Touchpad
7. Extra Rinse Touchpad
8. Start/Pause and Add Clothes Touchpad
9. Time Manager Touchpad
10. Delay End Touchpad
11. Display
12. Save Favourite Program Option
13. Child Lock Option

Display



- A)** Program Time
- B)** Time Manager Level
- C)** Add Clothes Icon
- D)** Program Phase Indication Icon:
 -  Ultramix phase
 -  Wash phase
 -  Rinse phase
 -  Spin phase
 -  Vapour phase
 -  Anticrease Phase Icon
- E)** Delay End Icon
- F)** Door Lock Icon

Program Chart

Program; Temperature range	Max. Spin Speed	Max. Load (Dry Clothes)	Type of load and soil level
Cottons; Cold to 90°C	1200 rpm	9 kg	White and coloured cotton. (Adjust wash time according to soil level. See Time Manager table on page 14)
Mixed; Cold to 60°C	1200 rpm	4 kg	Synthetic or mixed fabric items. (Adjust wash time according to soil level. See Time Manager table on page 14)
Bedding; Cold to 60°C	800 rpm	3 kg	Special program for one synthetic blanket, duvet, bedspread and so on. (Adjust wash time according to soil level. See Time Manager table on page 14)
Energy Saver; Cold and 40°C ¹⁾	1200 rpm	9 kg	White and colourfast cotton. Set this program to have a good washing results and decrease the energy consumption. The time of the washing program is extended.
Baby Care; Cold to 40°C	1200 rpm	4 kg	Baby cotton clothes and delicate knitting items with normal soil.
Vapour Refresh	–	1.5 kg	This cycle removes odours and helps to dewrinkle the laundry.  Do not add detergent.
Tub Clean 60°C	–	–	For cleaning the tub.
Spin	1200 rpm	9 kg	To spin the laundry and drain the water in the drum.
Rinse + Spin	1200 rpm	9 kg	To rinse and spin the laundry.

Program; Temperature range	Max. Spin Speed	Max. Load (Dry Clothes)	Type of load and soil level
Sports; Cold to 40°C	1200 rpm	4 kg	A gentle program designed for mixed fabrics found in delicate clothes.
Quick 15; 30°C	800 rpm	1.5 kg	Lightly soiled synthetics or mixed fabrics.
Daily 60; 30°C to 60°C	1200 rpm	5.5 kg	Coloured cotton e.g. shirts, blouses, towels and undergarments with normal level of soil.
Wool  ; Cold to 40°C	1200 rpm	2 kg	Specially tested program for woollen garments bearing the "Pure new woollen, non-shrink, machine washable" label.
Delicates; Cold to 40°C	1200 rpm	4 kg	Delicate fabrics such as acrylics, viscose, polyester items. (Adjust wash time according to soil level. See Time Manager table on page 14)
Favourite	–	–	Recall you favourite program.







1) Energy Saver program with 40degC and 1200rpm is recommended for a full load of normally soiled cottons, and is the Water and Energy rating label program.

Woolmark Apparel Care - Blue

The wool wash cycle of this machine has been approved by The Woolmark Company for the washing of wool garments labelled as "hand wash" provided that the garments are washed according to the instructions issued by the manufacturer of this washing machine. Follow the garment care label for drying and other laundry instructions. M1361 The Woolmark symbol is a Certification mark in many countries.



Program Options Compatibility

Program	Option						
	 No Spin	 Rinse Hold	 Time Delay Manager	 Time Delay End	 Vapour ¹⁾	 Prewash	 Extra Rinse
Cottons	○	○	○	○	○	○	○
Mixed	○	○	○	○	○	○	○
Bedding	○	×	○	○	○	×	×
Energy Saver	○	○	×	○	○	○	○
Baby Care	○	○	×	○	○	○	○
Vapour Refresh	×	×	×	○	○	×	×
Tub Clean	×	×	×	×	×	×	×
Spin	○	×	×	○	×	×	×
Rinse + Spin	○	○	×	○	×	×	×
Sports	○	○	×	○	×	○	○
Quick 15	○	○	×	○	×	×	×
Daily 60	○	○	×	○	×	×	○
Wool	○	○	×	○	×	×	×
Delicates	○	○	○	○	○	○	○
Favourite	-	-	-	-	-	-	-

1) Vapour option can be combined with temperature 40 to 90 °C only

Options

Temperature Touchpad

Press this touchpad repeatedly to increase or decrease the wash temperature if you want your laundry to be washed at a temperature different from the one proposed by the washing machine.

Spin Selection Touchpad

Press this touchpad repeatedly to increase or decrease the spin speed or select Rinse Hold, if you want your laundry to be spun at a speed different from the one proposed by the washing machine.

- 
No Spin

No spin option eliminates all the spin phases and increase the number of rinses.

- 
Rinse Hold

By selecting this option the water of the last rinse is not emptied out and the drum turns

regularly to prevent the laundry creases.

The door is still locked to indicate that the water must be emptied out.

The door stays locked with the water in the drum. To continue the cycle, you must press



(Start/Pause).

Time Manager

This option allows you to adjust the wash time. Press this touchpad repeatedly to decrease or increase the wash time according to the soil level of your wash. Use the table below as a guide.

Soil Level				
Light	>>	Medium	>>	Heavy
-	--	---	----	-----



Delay End Touchpad

Before you start the program, this option makes it possible to define the end of the washing program from minimum of 1 hour to maximum of 20 hours.

If program duration is longer than 3 hours, minimum Delay End option starts from 4 hours. After selecting Delay End time, press Start/Pause touchpad to start the program. Machine will then countdown and update time on the display every hours until it reaches the starting point of the wash cycle.

Press the Delay End touchpad to choose the end time as you wish. The display shows the number of hours and the indicator beside the touchpad is on.

This option must be selected after choosing the wash program, and before pressing the "Start/Pause" touchpad.

For example, if the program duration of your selected program is 3.20 hours and you define the "Delay End" time to 6 hours. This means your wash program will finish in 6 hours. (See diagram)

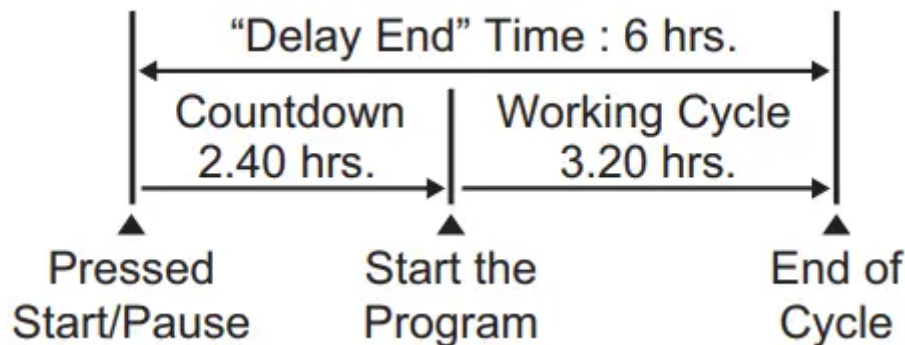

After selecting Delay End time, press Start/Pause touchpad to start the program. Machine will then countdown and update time on the display every hours until it reaches the starting point of the wash cycle.

If you wish to modify or cancel Delay End option after starting the program, follow the steps below:

- set the washing machine to PAUSE by pressing “Start/Pause” touchpad;
- deselect this option by pressing “Delay End” touchpad repeatedly till the display shows delay time



- press the “Start/Pause” to start the program.

Vapour Touchpad

Select this option to add approximately 30 minutes of tumbling in vapour during the wash cycle. Vapour helps open fabric fibers up to allow laundry additives to release tough stains. The indicator of this option will be on.

- Vapour may not necessarily be visible inside the drum during a vapour wash cycle. Vapour is created below the drum and allowed to naturally rise into the clothes.
- Vapour may not be present during the entire vapour wash cycle.
- Vapour function is more effective with half load.
- At the end of the Vapour cycle, the clothes will be warmer, softer and detached from the drum.

NOTE

If Vapour option is selected, rinse temperatures will be elevated.

During a vapour cycle, you may notice vapour exiting from the drain hose of the washing machine, this is normal and there is no cause for alarm.

Prewash Touchpad

Select this option if you wish your laundry to be pre-washed before the main wash. Use this option for heavy soil. The indicator of this option will be on.

When you set this function, put the detergent into the  compartment.

This function increases the program duration.

Extra Rinse Touchpad

This option is recommended for people who are allergic to detergents, and in areas where the water is very soft. Press this touchpad to add two rinse phases to a program. The indicator of this option will be on.

Settings

Save Favourite Program

Program settings that are frequently used can be saved (e.g. Cotton, 60°C, 1200 rpm, with Prewash and Vapour).

To program/re-program Favourite with your own selections and save them, proceed as follows:

1. Put machine in Stand-By mode.
2. Select your desired wash settings.
3. To save favourite program, press and hold “Prewash” touchpad about 2 seconds and you

will hear “Bip, Bip” sound and  is flashing on the display.

To recall the favourite wash program, turn selector knob to “Favourite ” program. You will get acknowledgement on the display when the Favourite program is loaded.

Child Safety Lock Option

Your appliance is provided with CHILD SAFETY LOCK which permits you to leave the appliance unsupervised with the door closed without having to worry that children might be injured by or cause damage to the appliance.

Set this option after pressing the Start/Pause touchpad.

To set “Child Lock” option:

- To activate the function, press and hold “Extra Rinse” touchpad about 2 seconds until the display shows the icon .

If you press any touchpad while Child Lock is activated, the icon  will flash on display 3 times along with buzzer sound.

The touchpads are locked (except for the On/Off button).

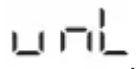

- To deactivate the function, press and hold “Extra Rinse” touchpad about 2 seconds until the display shows the icon .

This function remains enabled even after the appliance is switched off.

Enabling/Disabling End-Of-Wash Buzzer

This setting permits you to either enable or disable the buzzer at the end of the program. As an example, you might wish to disable this buzzer when you start a wash when going to bed, so that when the wash finished approximately 1 hour later, it will not disturb you through the night.

Error warning beeps such as critical faults are not disabled.

- To disable the buzzer sound, press “Vapour () and Spin” touchpads at the same time about 3 seconds, the icon  will show on display along with buzzer sound.
- To return to default configuration press these 2 touchpads at the same time about 3 seconds, the icon  will show on display along with buzzer sound.

Start/Pause () and Add Clothes () Touchpad

This touchpad has 2 functions:

1. 

Start/Pause

After you have selected the desired program and options, press this touchpad to start the machine. The Start/Pause pilot light will stop flashing and remain lit until the water level is above the bottom edge of the door then pilot light goes OFF. If you have selected a “Delay End” option, the countdown will begin and will be shown on the display.

To interrupt a program which is running, press this touchpad to pause the machine, the Start/Pause pilot light flashes.

To restart the program from the point at which it was interrupted, press this touchpad again, the Start/Pause pilot light will stop flashing.

2. 

Add Clothes

You can only add clothes when the icon  shown on the display.

To add clothes:

1. Pressing the “Start/Pause” touchpad to pause the program. You can only add clothes when the icon “ ” shown on the display.
2. Wait for the machine to come to a complete stop before opening the door (wait for door lock  icon to turn off).
3. Add clothing and close the door
4. Resume the program by pressing “Start/Pause” touchpad again.

BEFORE FIRST USE

NOTE

During installation or before first use you may observe some water in the machine. This is a residual water left in the machine after a full functional test in the factory to ensure the machine is delivered to customers in perfect working order and is no cause for concern.

1. Ensure that the electrical and water connections comply with the installation instructions.
2. Put 2 litres of water in the detergent compartment for washing phase. This activates the drain system.
3. Select a Cottons cycle at 90 °C, without any laundry in the machine, to remove any manufacturing residue from the drum and tub then start the machine



DAILY USE

Loading The Laundry

1. Turn the water tap on.
2. Connect the main plug to the main socket.
3. Press the On/Off button to turn on the washing machine. Turn the knob to set a program. The washing machine will propose a temperature and automatically select the spin value provided for the program you have chosen. The selector knob can be turned either clockwise or counter-clockwise.

4. Check and remove objects (if there are any) that could be trapped in the fold.

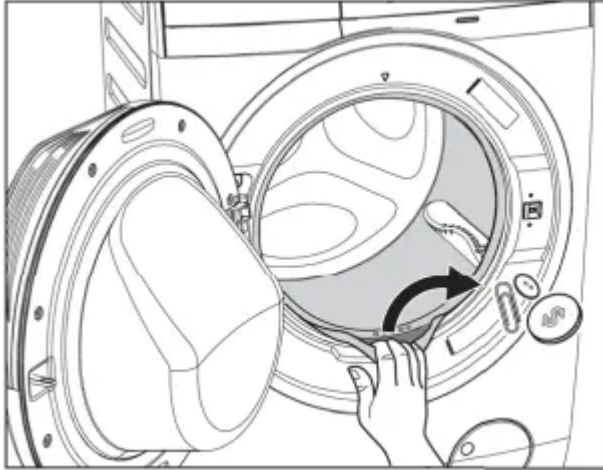

5. Place the laundry in the drum, one item at a time, shaking them out as much as possible.
(Refer to page 22 “WASHING HINTS”)
6. Close the door.

Make sure that no laundry remains between the seal and the door.

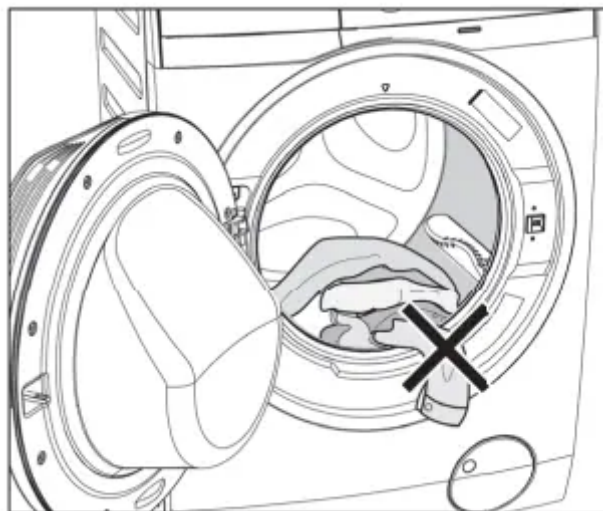

Using Detergent And Additives

IMPORTANT

Please read “Detergents Type and Quantity of Detergent” on page 23 before use.

1. Detergent Dispenser Drawer

The detergent dispenser is divided into three compartments.

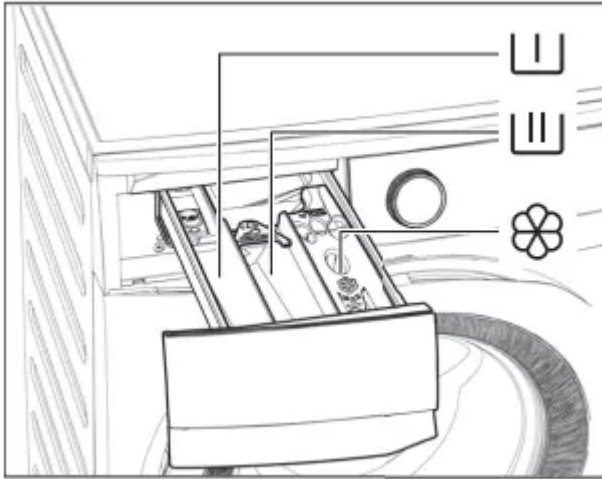

- 
 Compartment "PREWASH"

This compartment is only used for detergent when a "Prewash" option is selected.

- 
 Compartment "MAIN WASH" This compartment is used for detergent on all programs.

 Detergent flap



Position up:
for powder
detergent.

Position down:
for liquid
detergent.

- 
 Compartment "SOFTENER"

This compartment is used for fabric conditioner and starching agent.

NOTE: When you use the liquid detergent

- Do not use gelatinous or thick liquid detergents.
- Do not put more liquid than the maximum level.
- Do not set the "Prewash" phase.
- Do not set the "Delay End".

2. Measure out the detergent and the fabric softener;

- Pull out the dispenser drawer until it stops
- Measure out the amount of detergent required, pour it into the main wash compartment



- If you wish to carry out the “Prewash” phase, pour it into the compartment marked 

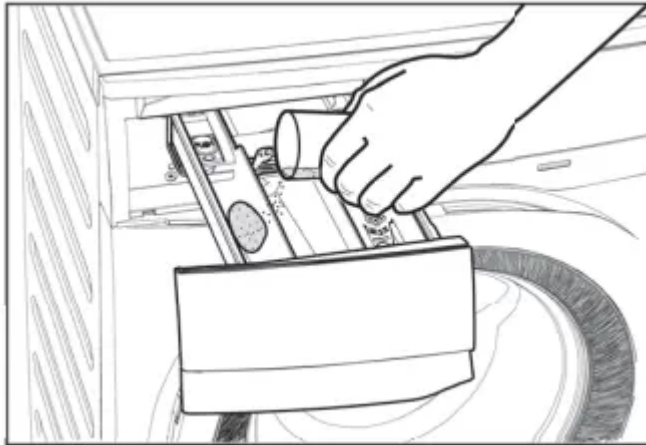

- If required, pour fabric softener into the compartment marked 



NOTE

The softener amount used must not exceed the “MAX” mark in the drawer.

If you use thick softeners it is recommended to dilute with water.

- Close the drawer gently.

NOTE

Residues of detergent, softener and water may remain in the dispenser. It is recommended to clean the dispenser regularly to remove any residue.

Options Setting

1. If you want your laundry to be spun or use temperature different from the one proposed by the washing machine, press “Spin” and “Temp” touchpads repeatedly to change the spin speed and temperature.

Press the option touchpads, if you want your laundry to be washed with special functions.

NOTE

- Different functions can be combined which is dependent on the program selected.
 - If an option is not compatible with the wash program selected, the icon “_ _ _” will flash on display along with buzzer sound.
2. If you want to adjust washing time, press the “Time Manager” touchpad repeatedly to increase or decrease washing time. (See Time Manager guide on page 14)
If you want to define the end of the washing program, press the “Delay End” touchpad repeatedly to choose your washing machine working time.

Starting A Cycle

To start a program, press the Start/Pause touchpad. The corresponding pilot light will stop flashing and a default program duration will be displayed on the screen.

After approx. 15 minutes from the start of a program:

- The appliance will automatically adjust the selected program duration according to the type and size of the load.
- The display will show adjusted program duration.

NOTE

If you press any touchpad while a program is operating, the icon “_ _ _” will flash on display along with buzzer sound. (except Start/Pause touchpad and On/Off button)

Interruption Of A Program

- To pause, press Start/ Pause. The indicator will start flashing.
- Press the Start/Pause again. The program will continue.

Changing A Program

Changing a running program is possible only by switching off the appliance.

- Press the “On/Off” button to cancel the program and to turn off the appliance.

- Press the “On/Off” button again to start the appliance.

Now you can set a new wash program and change any available options. Press Start/Pause to start the new program.

NOTE

The appliance will not drain the water (except programs; Vapour Refresh, Spin, Rinse + Spin, Tub Clean)

Changing The Options

It may be possible to change some of the options after a wash program has started.

1. Press the touchpad Start/Pause. The indicator will start flashing.
2. If available change the options that you wish
3. Press Start/Pause again. The program will continue.

Opening The Door

While a program or the Delay End is operating, the appliance door is locked and the display shows the indicator “”. First, set the machine to PAUSE by pressing the “Start/Pause” touchpad. Wait until the door lock indicator goes off, then the door can be opened.

If the door lock indicator “” does not disappear, this means that the machine is already heating and the water level is above the bottom edge of the door or the drum is turning. In this case the door CAN NOT be opened. If you need to open it, you must drain the water to open the door.

In case of emergency please refer to “Emergency door opening” on page 33.

At The End Of The Program

- The appliance stops automatically.
- The acoustic signal will operate.
- The display will show “End”.
- The indicator of the touchpad Start/Pause goes off.
- The door lock indicator “” goes off.
- Remove the laundry from the appliance. Make sure that the drum is empty.
- Keep the door partly open, to prevent the mildew and odours.
- Turn off the water tap.

NOTE

At the end of the program, the time remaining can suddenly decrease from 7 minutes or less to 0 due to the overestimated total program time during the load sensing phase. In some cases (with perfectly balanced load) the program time can be shorter than the time estimated after the load sensing phase is completed. This is a normal behavior of the machine and not a cause for concern as it does not compromise its performance.



When The Washing Program Is Completed, But There Is Water In The Drum

(Option “Rinse Hold  ” is used)

- The drum turns regularly to prevent the creases in the laundry.
- The indicator “Start/Pause” flashes to remind you to drain the water.
- The door lock indicator “ ” is on. The door stays locked.

You must drain the water to open the door.

To drain the water:

1. Press the “Start/Pause  ” touchpad. The appliance drains the water and spins with the maximum spin speed for selected program.
Alternatively, before pressing the “Start/Pause” touchpad, you can press the “Spin ” touchpad to change the spin speed. You can select “No Spin ()”, if you want the machine to only drain the water.
2. When the program is completed and the door lock indicator “ ” goes off, you can open the door.
3. Press the “On/Off” button to deactivate the appliance.

NOTE

After approximately 18 hours, if you do not press Start/Pause touchpad, the appliance will drain and spin automatically (except for “Wool” program) .

































AUTO Off Mode

The AUTO Off mode automatically deactivates the appliance to decrease the energy consumption when:

- You do not press any buttons for 5 minutes before you press “Start/Pause”.
Press the “On/Off” button to activate the appliance again
- After 5 minutes from the end of the washing program.
Press the “On/Off” button to reactivate the appliance. Display will show the end of the last wash.
Press any touchpad again to show the last wash program.

INTERNATIONAL WASH CODE SYMBOLS

These symbols appear on fabric labels, in order to help you choose the best way to treat your laundry.

 Energetic wash	 Max. wash temperature 95 °C	 Max. wash temperature 60 °C	 Max. wash temperature 40 °C	 Max. wash temperature 30 °C	 Hand wash	 DO NOT wash at all
 Delicate wash			 			
 Bleaching	 Bleach in cold water			 DO NOT bleach		
 Ironing	 Hot iron max. 200 °C	 Warm iron max. 150 °C	 Lukewarm iron max. 110 °C	 DO NOT iron		
 Dry cleaning	 Dry cleaning in all solvents	 Dry cleaning in perchlorethylene, petrol, pure alcohol, R 111 & R 113		 Dry cleaning in petrol, pure alcohol and R 113	 DO NOT dry clean	
 Drying	 Flat	 On the line	 On clothes hanger	 High temperature  Low temperature Tumble dry	 DO NOT tumble dry	

CARE AND CLEANING

WARNING

You must DISCONNECT the appliance from the electricity supply, before you can carry out any cleaning or maintenance work.

External Cleaning

Clean the appliance only with soap and warm water. Fully dry all the surfaces.

CAUTION!

Do not use alcohol, solvents or chemical products.

Descaling

The water we use normally contains lime. It is a good idea to periodically use a water softening powder in the machine.

Do this separately from any laundry washing, and according to the softening powder manufacturer's instructions.

This will help to prevent the formation of lime deposits.

After Each Wash

Leave the door open for a while. This helps to prevent mould and stagnant smells forming inside the appliance.

Keeping the door open after a wash will also help to preserve the door seal.

Maintenance Wash With “Tub Clean” Program

With the use of low temperature washes it is possible to get a build up of residues inside the drum.

We recommend to use “Tub Clean” program to clean the drum regularly to remove any residue.

To run a maintenance wash:

- The drum should be empty of laundry
- Select the “Tub Clean” program.
- Press Start/Pause to start the program.

Cleaning The Dispenser Drawer

The washing powder and additive dispenser drawer should be cleaned regularly

Remove the drawer by pressing the catch downwards and by pulling it out

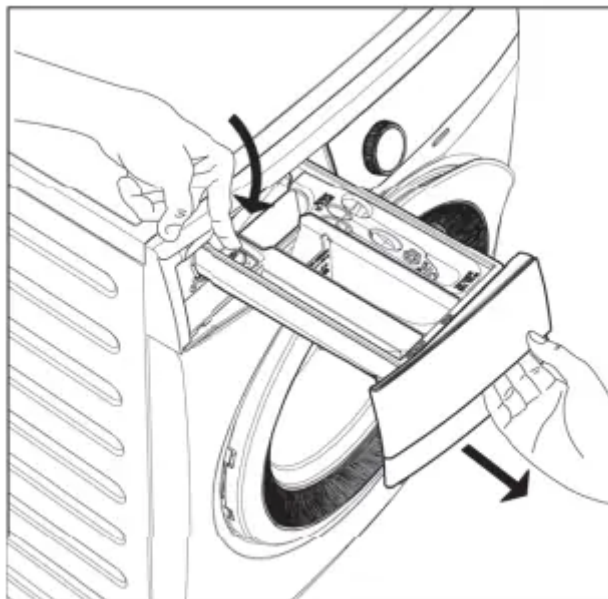

To aid cleaning, the top part of the additive compartment should be removed

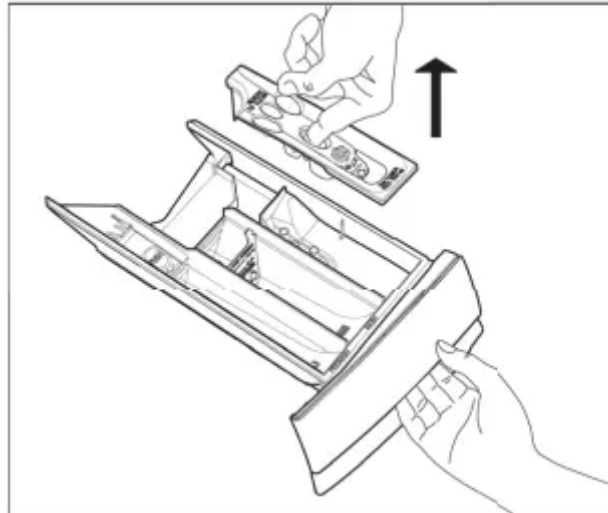

Flush it out under a tap to remove any traces of accumulated powder.

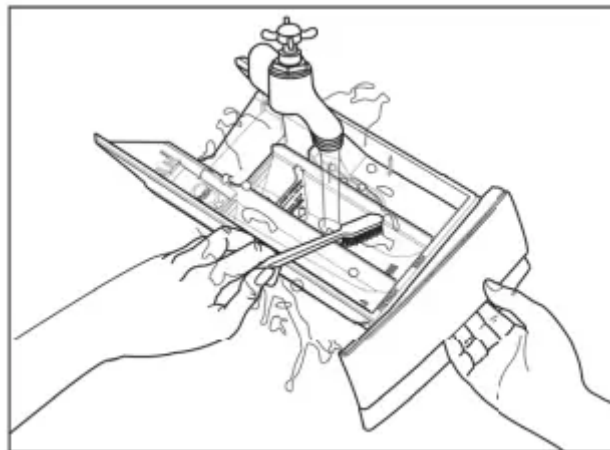

Cleaning The Drawer Recess

Having removed the drawer, use a small brush to clean the recess, ensuring that all washing powder residue is removed from the upper and lower part of the recess. Replace the drawer and run the rinse program without any clothes in the drum.

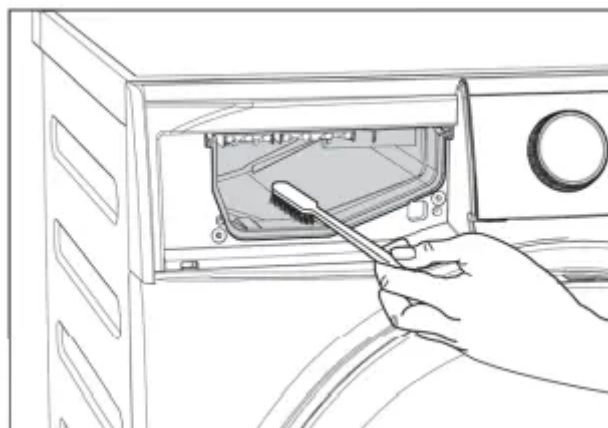

Cleaning The Pump

Regularly examine the drain pump and make sure that it is clean.

Clean the pump if:

- The appliance does not drain the water.
- The drum cannot turn.
- The appliance makes an unusual noise because of the blockage of the drain pump.
- The display shows an alarm code because of the problem with water drain.

WARNING!

1. Disconnect the mains plug from the mains socket.
2. Do not remove the filter while the appliance is operating. Do not clean the drain pump if the water in the appliance is hot. The water must be cold before you clean the drain pump.

To clean the drain pump:

1. Open the drain pump door.

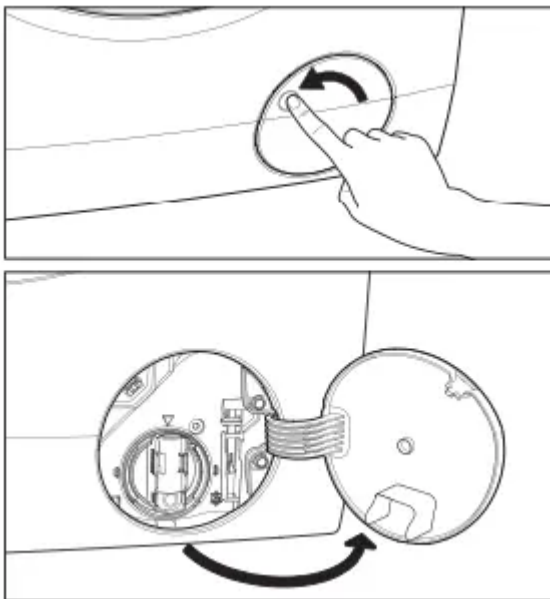

2. Place a suitable water container below the recess of the drain pump to collect the water that flows out.

Press the two levers and pull forward the drainage duct to let the water flow out.

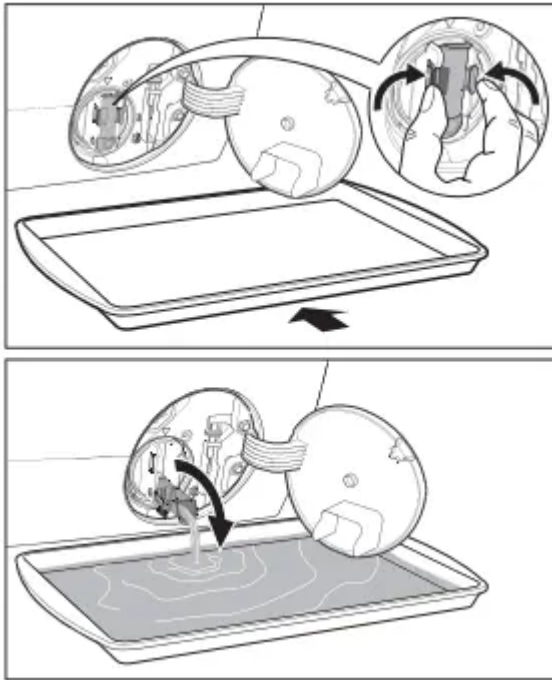

3. When the container is full of water, put the drainage duct back again and empty the container. Do step 2, 3 again and again until no more water flows out from the drain pump.



4. Push back the drainage duct and turn the filter counter-clockwise to remove it.

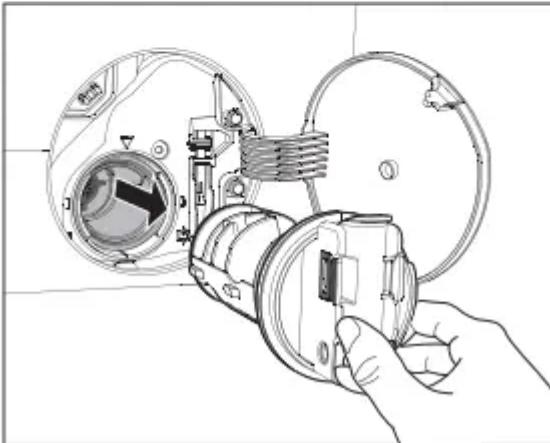
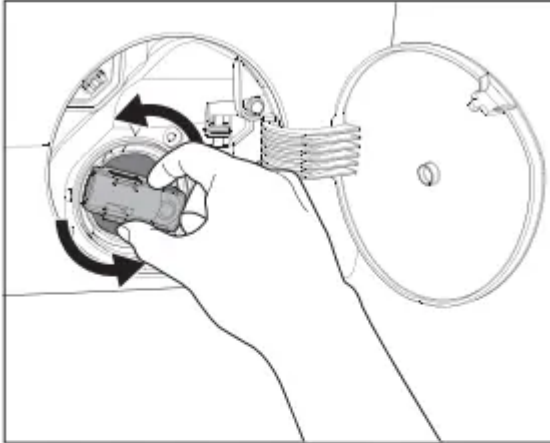

5. Remove fluff and objects from the pump (if there are any).

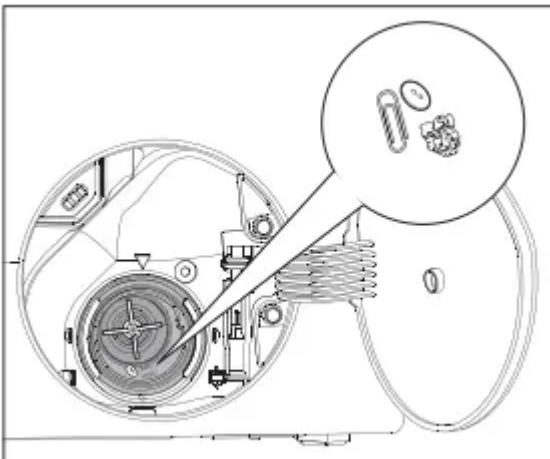

6. Make sure that the impeller of the pump can turn. If this does not occur, contact the service centre.

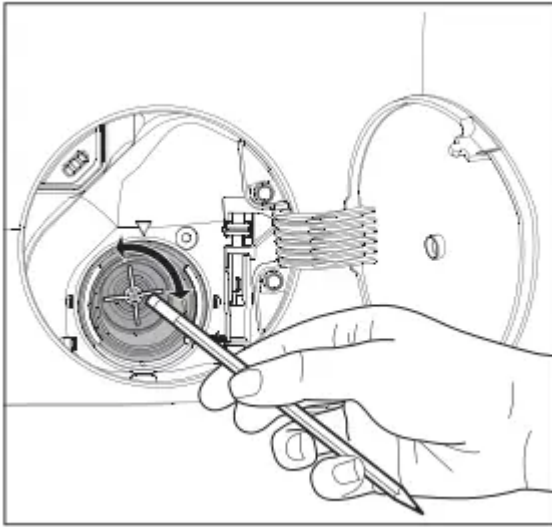

7. Clean the filter under the water tap.



- Put the filter back into the housing with exposed section facing up. Make sure that you correctly tighten the filter to prevent leakages.

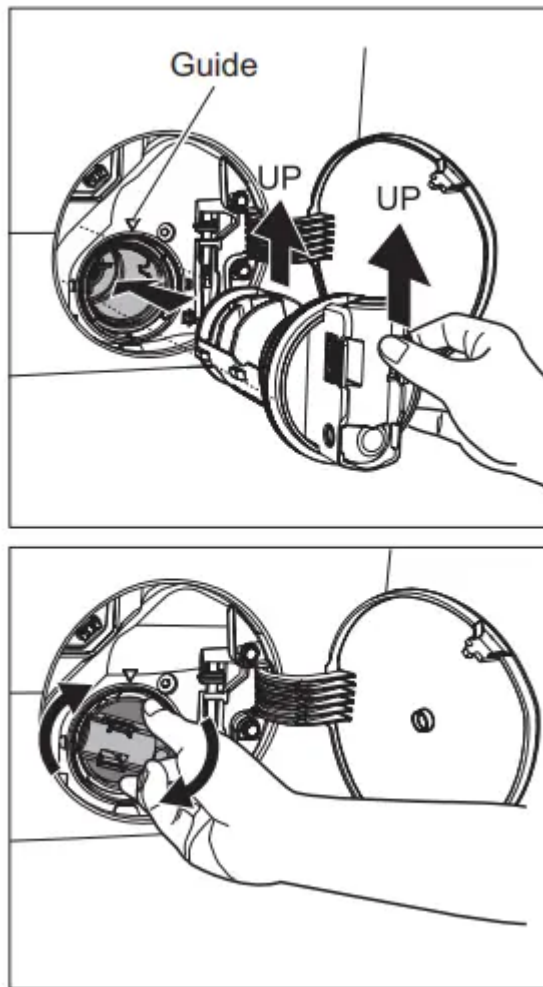

- Close the drain pump door.

Cleaning The Water Inlet Filter

If your water is very hard or contains traces of lime deposit, the water inlet filter may become clogged. It is therefore a good idea to clean it from time to time.

To clean the water inlet filters:

- Close the water tap.
- Remove the water inlet hose from the water tap.

3. Clean the filter in the inlet hose with a stiff brush.

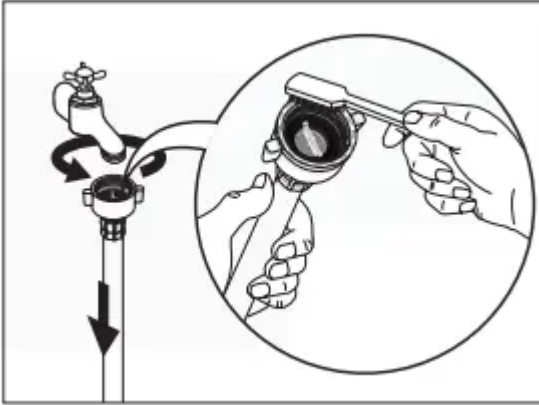

4. Remove the inlet hose behind the appliance.

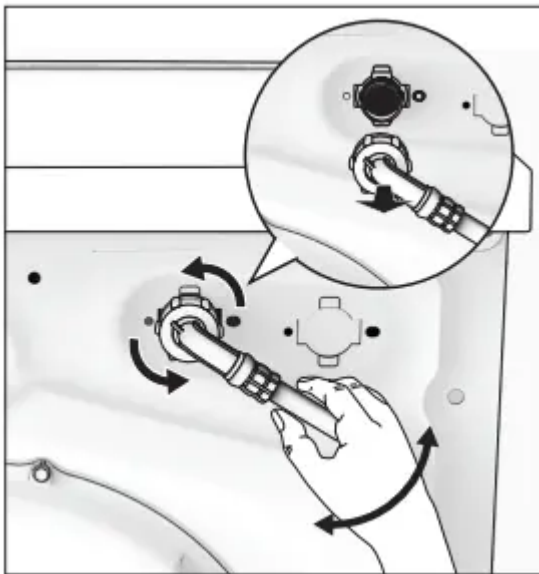

5. Clean the filter in the valve with a stiff brush or a towel.

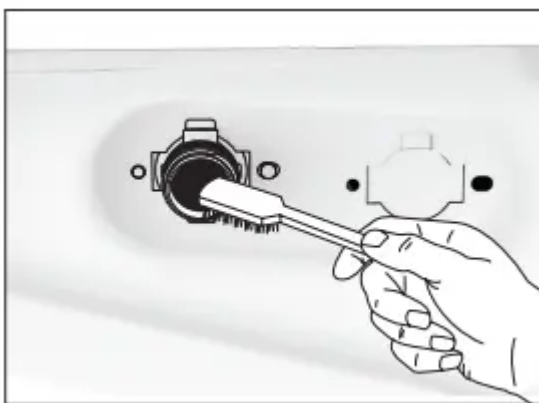

6. Install the inlet hose again. Make sure that the couplings are tight to prevent leakages.

7. Open the water tap.



Frost Precautions

If the appliance is installed in an area where the temperature can be less than 0 °C, remove the remaining water from the inlet hose and the drain pump.

Emergency Drain

1. Disconnect the main plug from the main socket. Turn off the water tap.
2. Remove the water inlet hose.
3. Remove the drain hose from the rear support and unhook it from sink or spigot.

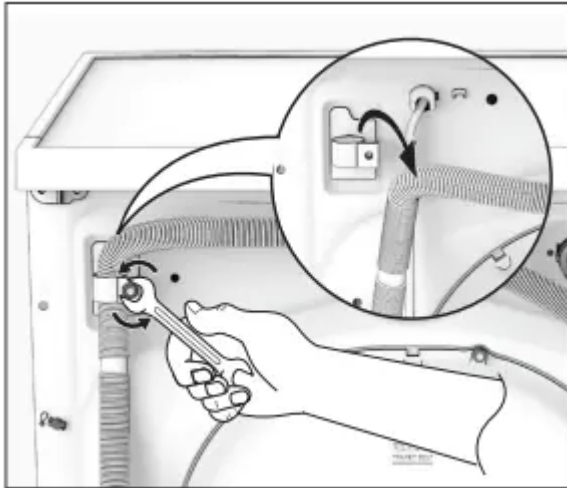

4. Put the end of the drain and inlet hose in a container. Let the water flow out of the hoses.

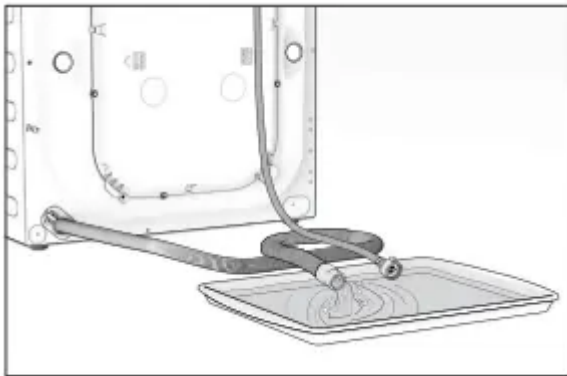

5. When no more water flows, install the inlet hose and the drain hose again.

NOTE

Make sure that the temperature is more than 0 °C before you use the appliance again.

TROUBLESHOOTING

Possible Failures

Certain problems are due to lack of simple maintenance or oversights, which can be solved easily without calling out an engineer. Before contacting your local Service Centre, please check troubleshooting.

Once the problem has been eliminated, press the Start/Pause button to restart the program. If after all checks, the problem persists, contact your local Service Centre.

WARNING! Deactivate the appliance before you do the checks.

Alarm Code:

	The appliance does not fill with water properly.
	The appliance does not drain the water.
	The appliance door is open or not closed correctly. Please check the door!
	The main supply is unstable. Wait until the main supply is stable.
	No communication between electronic elements of the appliance. Switch off and switch on again.

Malfunction	Possible cause	Solution
<p>Machine does not start:</p>	<p>The door has not been closed. (Error code: E40)</p> <p>The plug is not properly inserted into the power socket.</p> <p>There is no power at the socket.</p> <p>The Start/Pause touchpad has not been pressed.</p> <p>The “Delay End” has been selected.</p> <p>The Main supply is unstable. (If E40 appears on the display.)</p>	<p>Close the door firmly.</p> <p>Insert the plug into the power socket.</p> <p>Please check your domestic electrical installation.</p> <p>Press the Start/Pause touchpad.</p> <p>If the laundry are to be washed immediately, cancel the “Delay End”.</p> <p>Wait until the main supply is stable. Appliance will start automatically.</p>
<p>Machine does not fill the water:</p>	<p>The water tap is closed. (Error code: E 10)</p> <p>The inlet hose is squashed or kinked. (Error code: E 10)</p> <p>The filter in the inlet hose is blocked. (Error code: E 10)</p> <p>The door is not properly closed. (Error code: E40)</p>	<p>Open the water tap.</p> <p>Check the inlet hose connection.</p> <p>Clean the water inlet hose filter.</p> <p>Close the door firmly.</p>
<p>Machine fills then empties immediately:</p>	<p>The end of the drain hose is too low. (Error code: E 10)</p>	<p>Refer to relevant paragraph in “water drainage” section.</p>
<p>Machine does not empty and/or does not spin:</p>	<p>The drain hose is squashed or kinked. (Error code: E20)</p> <p>The drain pump is clogged. (Error code: E20)</p>	<p>Check the drain hose connection.</p> <p>Clean the drain filter</p> <p>Press Start/Pause touchpad to drain the</p>

	<p>The option “Rinse Hold” has been selected.</p> <p>The laundry is not evenly distributed in the drum.</p>	<p>water or select spin program.</p> <p>Pause the machine and redistribute laundry manually.</p>
<p>There is water on the floor:</p>	<p>Too much detergent or unsuitable detergent (creates too much foam) has been used.</p> <p>Check whether there are any leaks from one of the inlet hose fittings. It is not always easy to see this as the water runs down the hose; check to see if it is damp.</p> <p>The drain hose is damaged.</p>	<p>Reduce detergent quantity and use correct type of detergent (refer page 23).</p> <p>Check the water inlet hose connection.</p>
<p>Unsatisfactory washing results:</p>	<p>Too little detergent or unsuitable detergent has been used.</p> <p>Stubborn stains have not been treated prior to washing.</p> <p>The correct temperature was not selected.</p> <p>Excessive laundry load.</p>	<p>Increase detergent quantity or use different detergent (refer page 23).</p> <p>Use commercial products to treat the stubborn stains.</p> <p>Check if you have selected the correct temperature.</p> <p>Reduce load.</p>
<p>The door will not open:</p>	<p>The program is still running.</p> <p>There is water in the drum.</p> <p>This problem may be caused by a failure of the appliance.</p>	<p>Wait until the end of cycle.</p> <p>You must drain the water to open the door (refer “Opening The Door” on page 20).</p> <p>Contact Service. If you need to open the door, please read carefully “Emergency door opening” on page 33.</p>
<p>Machine vibrates or is noisy:</p>	<p>The transit bolts and packing have not been removed.</p>	

	The support feet have not been adjusted.	<p>Check the correct installation of the appliance.</p> <p>Check the correct levelling of the appliance.</p>
Machine vibrates or is noisy:	<p>The laundry is not evenly distributed in the drum.</p> <p>There is very little laundry in the drum</p> <p>Unstable floors eg. wooden floors</p>	<p>Pause the machine and redistribute laundry manually.</p> <p>Load more laundry.</p> <p>Refer to relevant paragraph in “Positioning” section.</p>
Cycle time longer than displayed:	<p>Detergent over dose.</p> <p>Machine unbalance</p>	<p>Reduce the detergent quantity or use another one. (Refer page 23 “Detergents Type And Quantity Of Detergent”).</p> <p>Redistribute laundry manually in the drum and start the spin phase again.</p>
The cycle is shorter than the time displayed.	The appliance calculated a new time according to the laundry load.	

<p>Spinning starts late or machine does not spin:</p>	<p>The electronic unbalance detection device has cut in because the laundry is not evenly distributed in the drum. The laundry is redistributed by reverse rotation of the drum.</p> <p>This may happen several times before the unbalance disappears and normal spinning can resume. If, after 10 minutes, the laundry is still not evenly distributed in the drum, the machine will not spin. In this case, redistribute the load manually and select the spin program.</p>	<p>Pause the machine and redistribute laundry manually.</p>
<p>Machine makes an unusual noise:</p>	<p>Machine not installed properly.</p> <p>Transit bolts or packaging not removed.</p> <p>The load may be too small.</p>	<p>Make sure the levelling of the appliance is correct. Refer to “Installation”.</p> <p>Make sure that the packaging and/or the transit bolts are removed. Refer to “Unpacking”.</p> <p>Add more laundry in the drum.</p>
<p>No water is visible in the drum:</p>	<p>Machines based on modern technology operate very economically using very little water without affecting performance.</p>	

NOTE

If you are unable to identify or solve the problem, contact our service centre. Before calling service centre, make a note of the model, serial number and purchase date of your machine: the Service Centre will require this information.



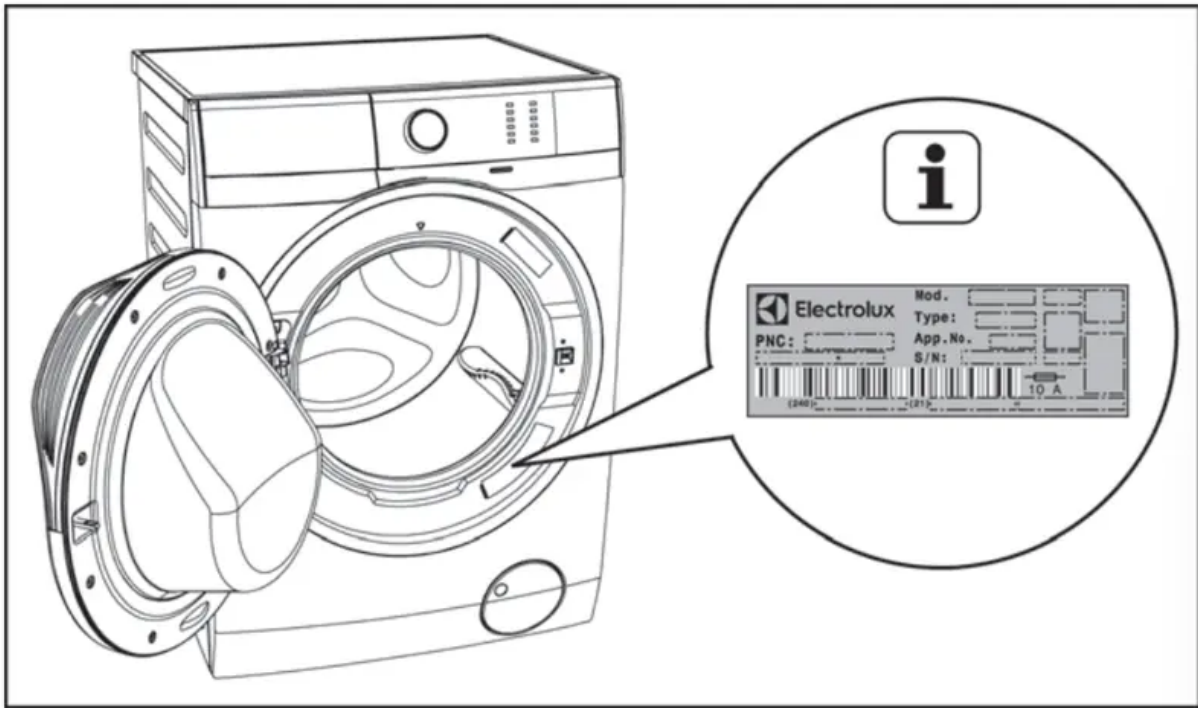

Emergency Door Opening

In case of power failure or appliance failure, the appliance door remains locked. The wash program continues when power is restored. If the door remains locked in case of failure, it is possible to open it using the emergency unlock feature.

Before opening the door:

WARNING!

Make sure that the water temperature and the laundry are not hot. Wait until they cool down if necessary

Make sure that the water level inside the drum is not too high. If necessary, perform an Emergency Drain (see page 29)

Make sure that the drum is not rotating. Wait until the drum stops rotating if necessary

To open the door proceed as follows:

1. Press the On/Off button to switch the appliance off.
2. Disconnect the mains plug from the mains socket.
3. Open the filter cover
4. Without touching the door. Insert a small flathead screw driver into the slot on emergency unlock strap (red strap) and pull down twice then pull the door open. Repeat if unsuccessful.

Note: Do not pull down emergency strap too hard.

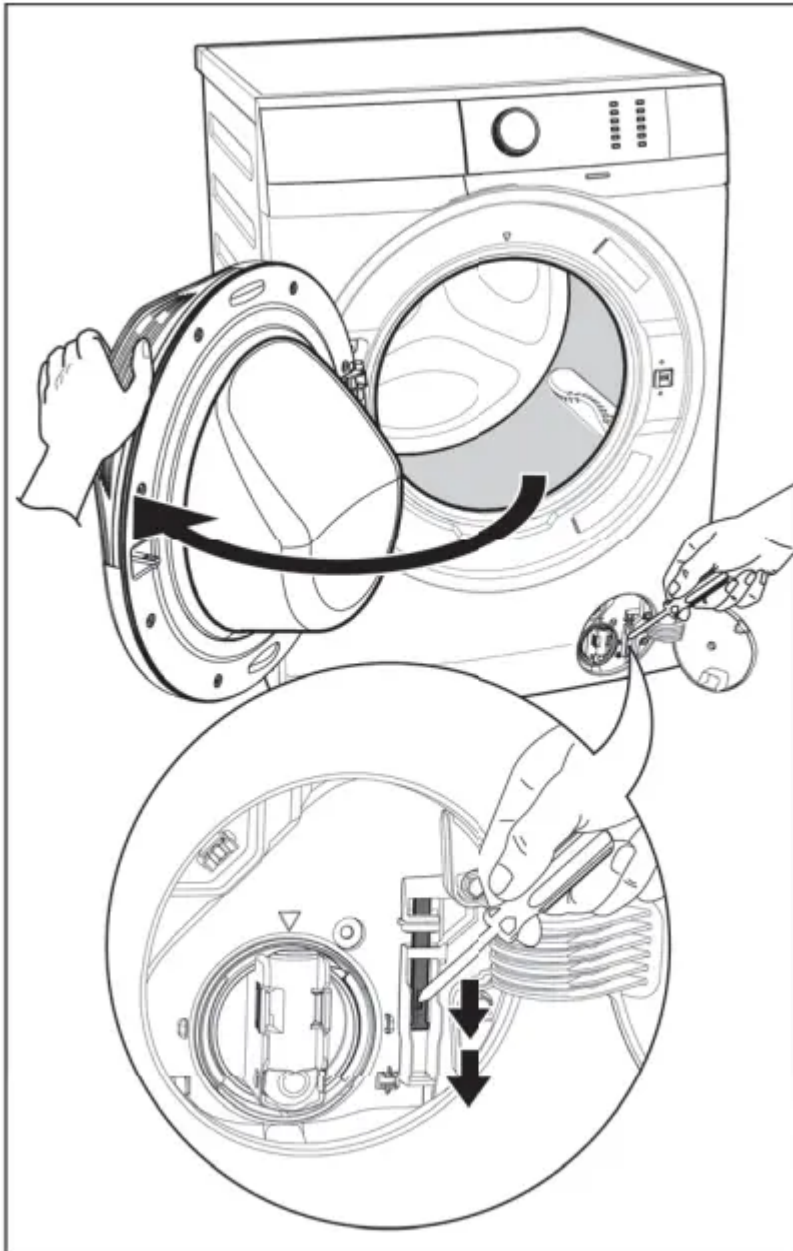

5. Take out the laundry
6. Close the filter flap.

Warning

This content is compiled from multiple sources and is provided for reference purposes only. It may not be complete or fully applicable to all situations. If you are unable to resolve your issue, please contact the product manufacturer or an authorized service provider for official support.