

## Quick Start Guide

READ COMPLETE USER GUIDE FOR FULL INSTRUCTIONS ON USE, MAINTENANCE AND IMPORTANT SAFETY NOTICES

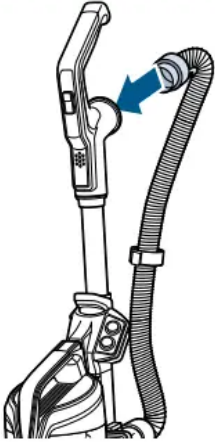
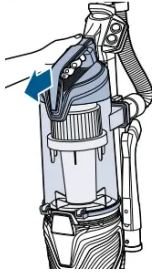

<p><b>1</b></p>  <p>Slide end of wand into top of base. It will “click” when inserted correctly.</p>	<p><b>2</b></p>  <p>Attach Stretch Hose by lining the tabs on the cuff with the notches on the back of the vacuum. Twist clockwise to lock hose into place.</p>	<p><b>3</b></p>  <p>Remove Dirt Tank. Press the Dirt Tank Release Button and pull away from vacuum.</p>
---	---	--

4

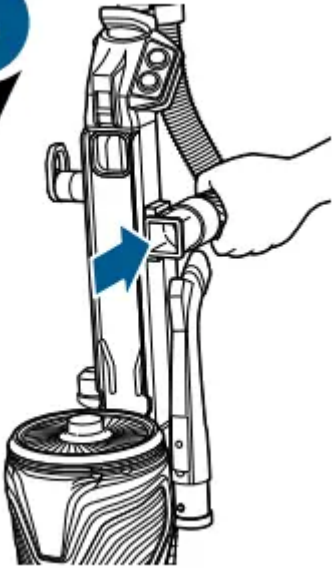

Attach end of hose to vacuum by sliding square cuff into the bracket below the Power Switch.

5

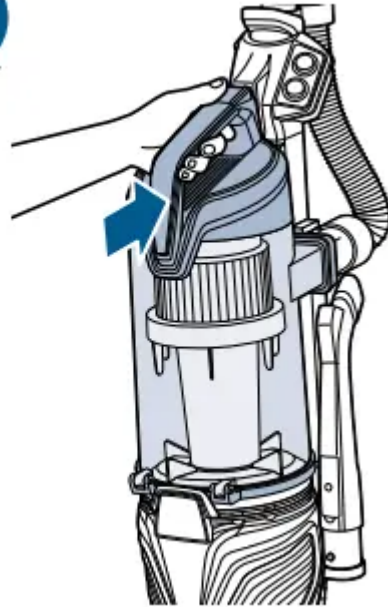

Place the Dirt Tank on the vacuum by securing the bottom in place first, then pushing back until you hear a "click".

6

### Install Optional Febreze Filter

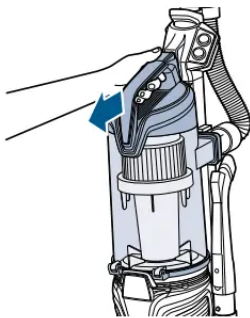

Press the Dirt Tank Release Button and pull away from vacuum.

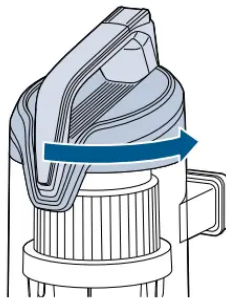

Twist tank cover to the unlock position then pull up on Handle.

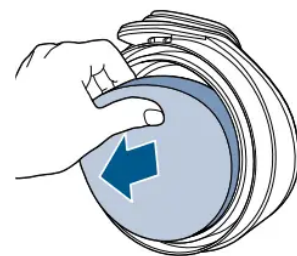

Remove the Pre-Motor Filter and replace with the Febreze Filter.

Certain trademarks used under license from The Procter & Gamble Company or its affiliates.



## What's in the Box?

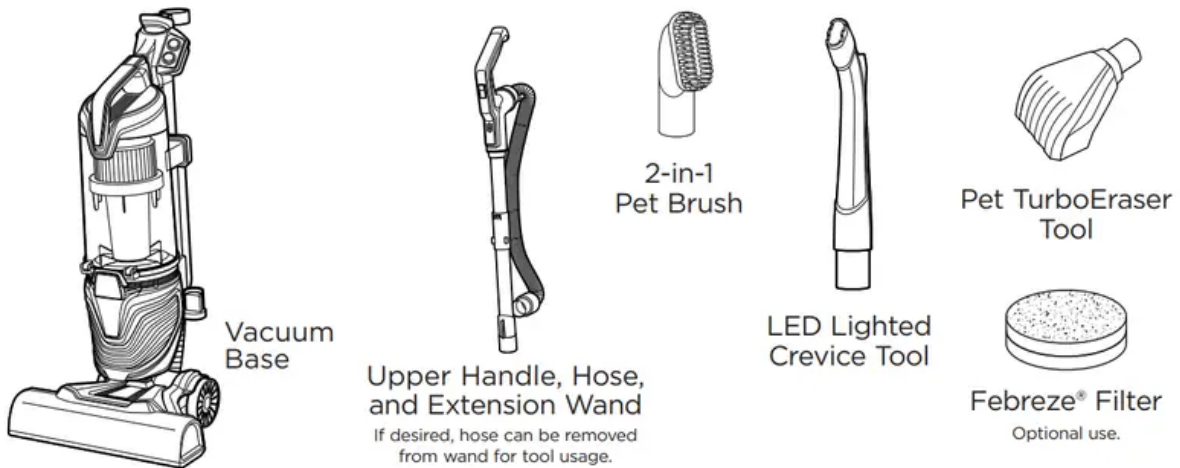

**NOTE:** Standard accessories may vary by model. To identify what should be included with your purchase, please refer to the “Carton Contents” list located on the carton top flap.

## Product View

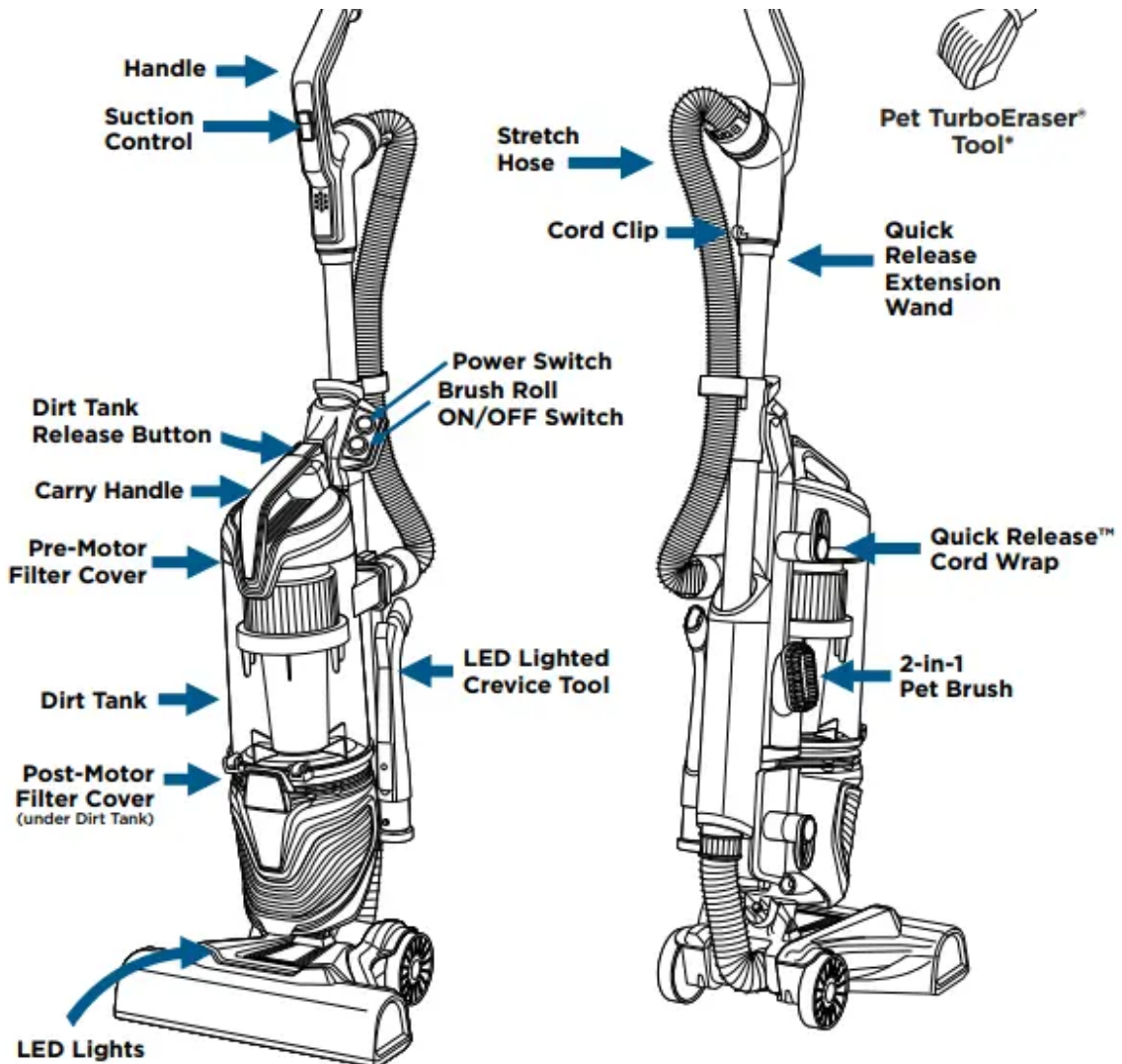

\*NOTE: Pet TurboEraser® Tool does not store on unit.

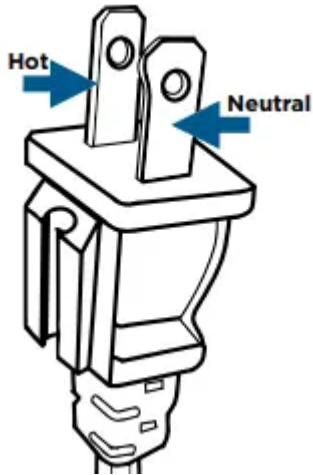

### THIS APPLIANCE HAS A POLARIZED PLUG



To reduce the risk of electric shock, this appliance has a polarized plug (one blade is wider than the other). This plug will fit in a polarized outlet only one way. If the plug does not fit fully in the outlet, reverse the plug. If it still does not fit, contact a qualified electrician to install a proper outlet. Do not change the plug in any way

## Operations

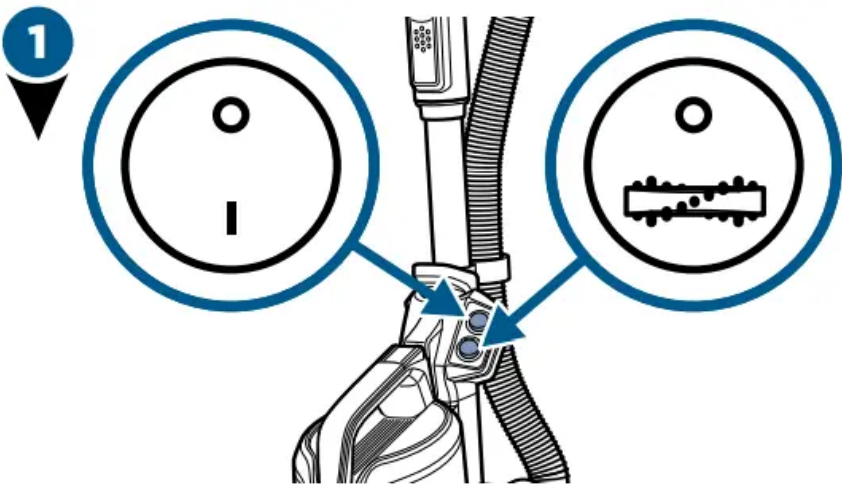
**WARNING** Do not plug in your vacuum until you are familiar with all instructions and operating procedures.



 <p>1</p> <p>Turn vacuum ON by pressing Power Switch ON (I - ON and O - OFF). Press Brush Roll ON/OFF Switch to run the PowerBrush for carpet cleaning (Brush Roll is on when light on switch is illuminated). See page 13 to maintain the Brush Roll.</p>	 <p>2</p> <p>Step gently on base and pull back on Handle to recline.</p>
--	---

**NOTE:** The Brush Roll will automatically shut off when vacuum is locked in upright position. Recline to reactivate.

**NOTE:** In the unlikely event that hair wrapped around your Brush Roll, run vacuum back and forth on clean carpet several times to help release any wrapped hair. Turn vacuum ON by pressing Power Switch ON (I - ON and O - OFF). Press Brush Roll ON/OFF Switch to run the PowerBrush for carpet cleaning (Brush Roll is on when light on switch is illuminated). See page 13 to maintain the Brush Roll.

**NOTE:** Turn OFF the Brush Roll when vacuuming hard or delicate surfaces that may be caught by the rotating brush. This could include hard wood, tiled floors, small area rugs, or frieze carpets that have long delicate fibers or threads.

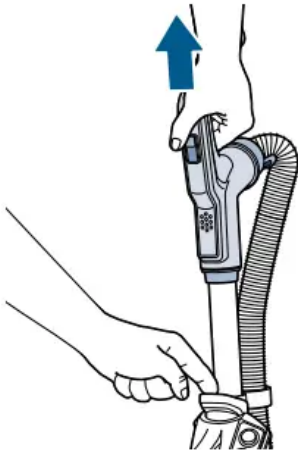
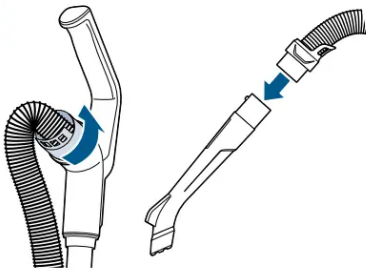
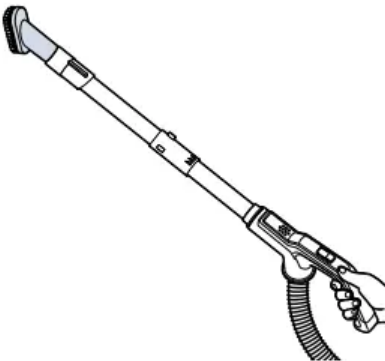
### Adjusting the Suction Control

<p><b>1</b></p>  <p>Clean hard to reach spaces with the Quick Release Extension Wand. Push the release button to remove and attach desired tool.</p>	<p><b>2</b></p>  <p>If desired, the Stretch Hose can be removed from the Extension Wand. To do so, twist hose from the back of the wand to remove.</p>
<p><b>3</b></p>  <p>Attach desired tool. Use the Pet TurboEraser® Tool for best results on stairs. Or use the 2-in-1 Pet Brush with soft, white bristles for sensitive/gentle surfaces and rubber nubs to pick up embedded pet hair.</p>	<p><b>4</b></p>  <p>When finished, replace the wand back on the vacuum by sliding into place until you hear “click”.</p>

## Vacuum Motor Protection

An internal thermal protector has been designed into your vacuum to protect it from overheating. When the thermal protector activates, the main vacuum motor will stop operating. The front lights will remain on, even though the motor turns OFF. If this happens, proceed as follows.

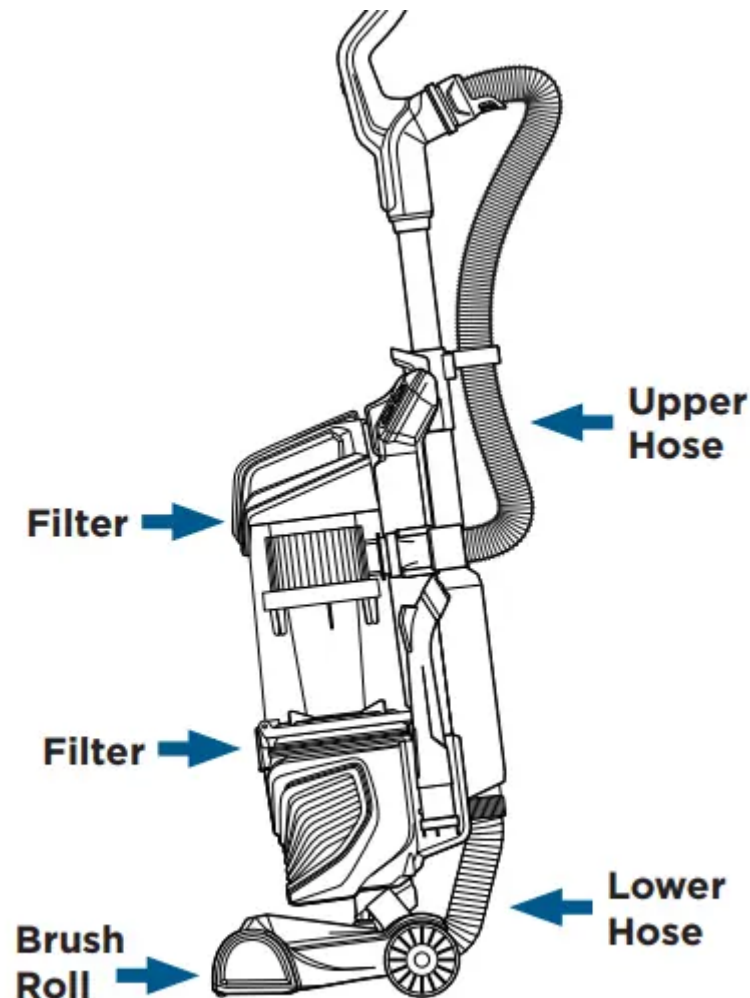

### Possible areas that could clog.

1. Turn vacuum OFF and unplug from electrical outlet.
2. Check for the source of overheating problem (full Dirt Tank, dirty filters, or a clog) and fix by following the maintenance instructions.
3. When the motor cools for approximately 30 minutes, the thermal protector automatically resets and cleaning may continue. If the vacuum will not turn ON or the thermal protector continues to activate, your vacuum may need servicing. Contact BISSELL Consumer Care

**NOTE:** The thermal protector controls the main vacuum motor only, not the brush motor. If the thermal protector activates, brush and lights will continue to operate normally; however, there will be no suction.

## Remove/Empty Dirt Tank

**WARNING** To reduce the risk of electrical shock, turn Power Switch OFF and disconnect polarized plug from electrical outlet before performing maintenance or troubleshooting checks.

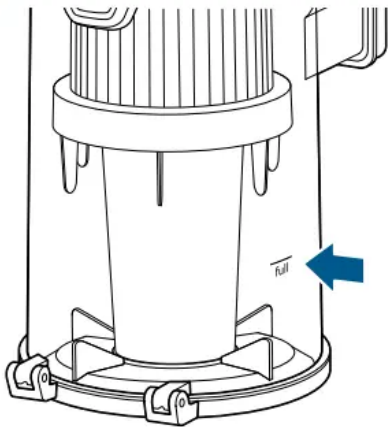
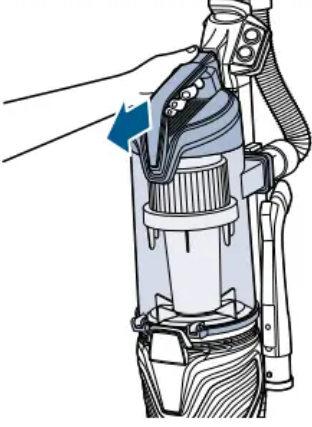
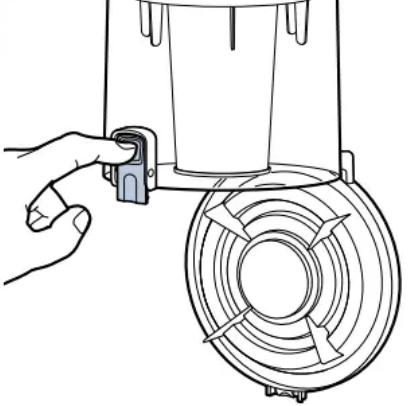
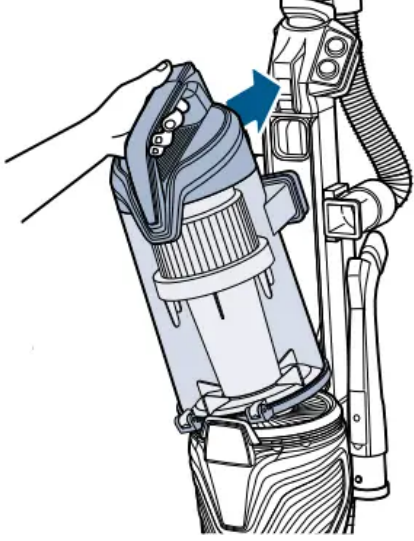
<p><b>1</b></p>  <p>The Dirt Tank is full. Time to empty!</p>	<p><b>2</b></p>  <p>Press the Tank Release Button and grab the Handle to pull the Dirt Tank away from vacuum</p>
<p><b>3</b></p>  <p>Hold the Dirt Tank over a trash bin and press the Empty Button. Once emptied, snap bottom back into place</p>	<p><b>4</b></p>  <p>Return the Dirt Tank to the vacuum, securing the bottom in place first and then pushing back until you hear a "click".</p>

**WARNING** Do not operate vacuum with damp or wet filters. Allow components to dry before reassembling the Dirt Tank.



**WARNING** Before using your vacuum, make sure that the Dirt Tank is in locked position and that all filters, both pre- and post-filters, are in place. DO NOT operate your vacuum without these filters.

## Clean/Replace Pre-Motor Filters

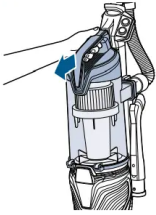
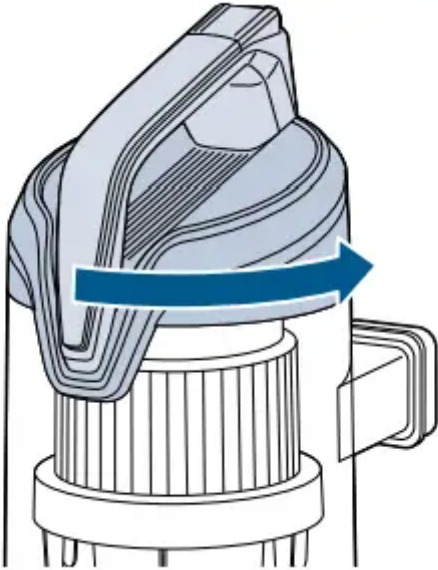
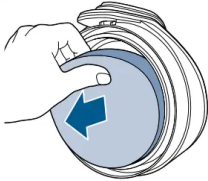

**WARNING** To reduce the risk of electrical shock, turn Power Switch OFF and disconnect polarized plug from electrical outlet before performing maintenance or troubleshooting checks.

**WARNING** Do not operate vacuum with damp or wet filters. Allow components to dry before reassembling the Dirt Tank.

<p><b>1</b></p>  <p>Press the Dirt Tank Release Button and pull away from vacuum.</p>	<p><b>2</b></p>  <p>Twist tank cover to the unlock position then pull up on Handle.</p>
<p><b>3</b></p>  <p>Remove Pre-Motor Filter from top of Dirt Tank lid by pulling out.</p>	<p><b>4</b></p>  <p>Both Pre-Motor Felt and Foam Filters are washable. Clean with mild detergent, rinse and squeeze all excess water. Allow filters to dry completely before reinserting. Return Pre-Motor Filters to the top of the Dirt Tank, placing the thick Foam Filter in last.</p>



**NOTE:** Replace filters every 3 to 6 months. Visit [BISSELL.com](http://BISSELL.com) for filter replacements.

**NOTE:** Washing may decrease the Febreze odor eliminating scent.

Certain trademarks used under license from The Procter & Gamble Company or its affiliates.

**WARNING** To reduce the risk of electrical shock, turn Power Switch OFF and disconnect polarized plug from electrical outlet before performing maintenance or troubleshooting checks.

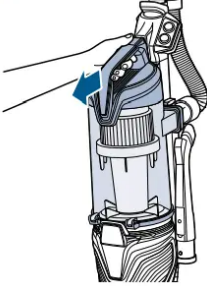
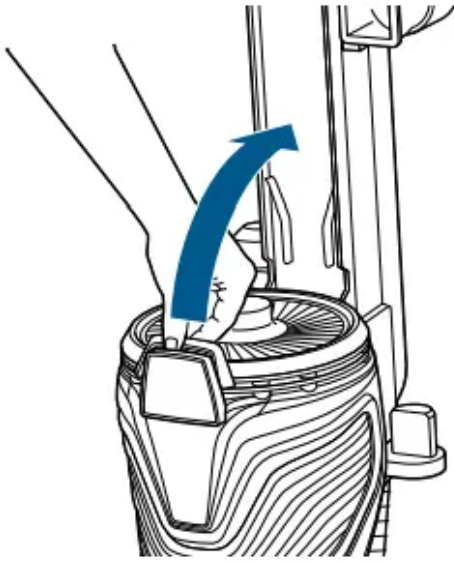
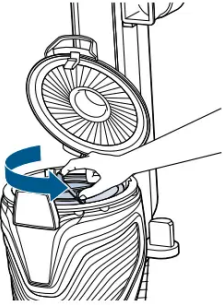
**WARNING** Do not operate vacuum with damp or wet filters. Allow components to dry before reassembling the Dirt Tank.

<p><b>1</b></p>  <p>Press the Dirt Tank Release Button and pull Dirt Tank away from vacuum.</p>	<p><b>2</b></p>  <p>Pull tab up to access Post-Motor Filter</p>
<p><b>3</b></p>  <p>Twist filter counter-clockwise to unlock and remove from vacuum.</p>	<p><b>4</b></p>  <p>When reassembling, be sure to lock the filter back into place. The pleated filter may NOT be washed. If dust/debris accumulates, gently tap the filter on the inside of a trash container.</p>

**NOTE:** Replace filters every 3 to 6 months. Visit [BISSELL.com](http://BISSELL.com) for filter replacements.

## Clean Inner Cyclone Separator

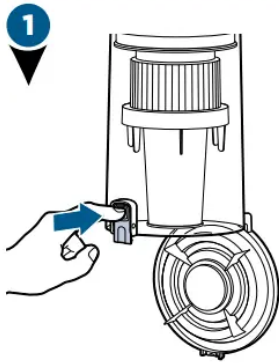

1  
Hold the Dirt Tank over a trash container. Press the bottom release button to empty.

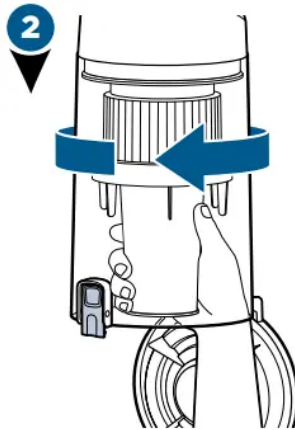

2  
Twist Cyclone counterclockwise and pull down to remove from tank.

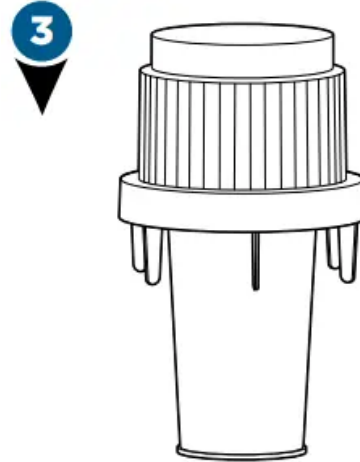

3  
Tap separator against inside of trash container and rinse under warm water, if necessary. Be sure to let it dry completely before placing back in Dirt Tank.

## Maintain Pet TurboEraser® Tool

1

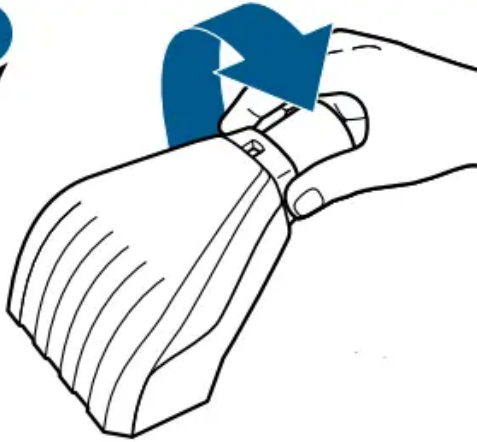

Twist gray collar counter-clockwise, until slot appears, and then separate faceplate.

2

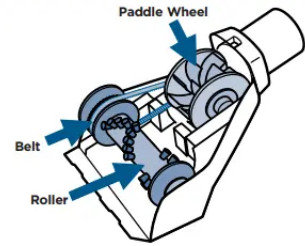

Remove Brush Roll, Belt, and Paddle Wheel. Inspect for damages and replace if necessary

3

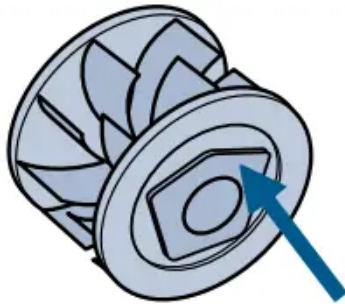

To reassemble, align two clips on each end of Paddle Wheel with Belt on and pop back into place. Place Brush Roll with Belt back in. Faceplate will not close properly if all parts are not aligned correctly

4

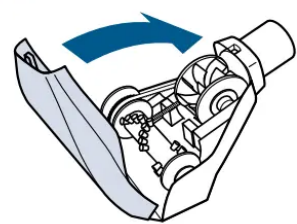

To put faceplate back on, align the tabs in the top of the cover and place it down to “click” into place.

## Replace Brush and Belt

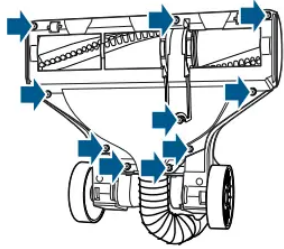
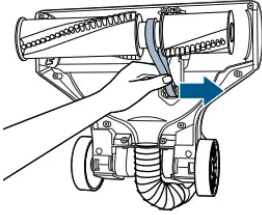
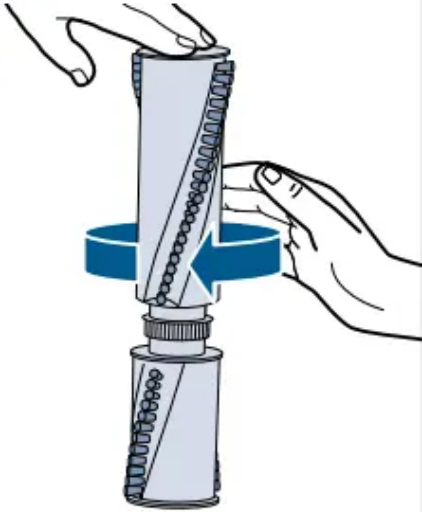

<p><b>1</b></p>  <p>Unplug and turn vacuum over. Unscrew 10 Phillipshead screws to remove bottom cover.</p>	<p><b>2</b></p>  <p>Pull Brush Roll straight out and slide Belt off motor gear. Replace Brush Roll and/or Belt.</p>	<p><b>3</b></p>  <p>Inspect Brush Roll by placing it on its end and spinning. The Brush Roll should spin freely, multiple times by one flick. If it doesn't, replace Brush Roll. Inspect Belt, replace if it appears damaged.</p>
--	--	---

**4**

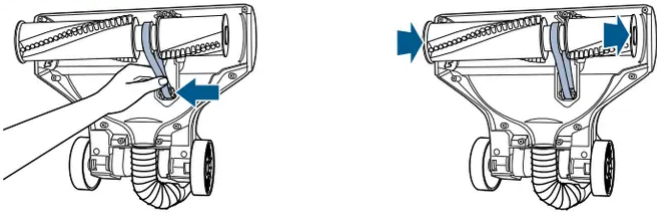

1. Place Belt back on Brush Roll.
2. Pinch Belt around Brush Roll & hook back around the motor gear.
3. Rotate Brush Roll into place and line up end caps.
4. Re-attach bottom cover with 10 screws

**NOTE:** If an object becomes lodged in foot and brush shuts OFF, turn vacuum OFF and unplug from electrical outlet. Remove obstruction and brush will automatically reset when vacuum is plugged and turned back ON.

## Parts & Supplies

For Parts and Supplies, go to [www.BISSELL.com](http://www.BISSELL.com) and enter your model number in the search field.



## Troubleshooting

**WARNING** To reduce the risk of electric shock, turn Power Switch OFF and disconnect plug from electrical outlet before performing maintenance or troubleshooting checks.

<b>Problem</b>	<b>Possible causes</b>	<b>Remedies</b>
<b>Brush Roll doesn't rotate</b>	Brush Roll switch is turned OFF.	Make sure Brush Roll switch is ON.
	Vacuum is locked in upright position.	Recline vacuum and switch ON the Brush Roll.
	Vacuumping on Premium Soft Carpet.	Adjust Suction Control to reduce suction on softer carpets.
	Brush Roll has lodged debris or other entanglements, keeping the brush from rotating.	Unplug to reset brush motor, checking for and removing debris before turning ON.
<b>Vacuum won't pick up dirt</b>	Filters are dirty.	Remove and rinse Pre-Motor Filters. Allow enough time for them to dry properly before reinserting. Remove and dust off Post-Motor Filter.
	There is a clog in the vacuum.	Remove bottom cover and check for any buildup of debris. Remove debris and debris buildup before reinstalling bottom cover.
	Dirt Tank is not seated correctly.	Press the Tank Release to release the Dirt Tank and reseal properly.
	There is a crack or hole in the Main Hose.	If there is a crack or hole, order a new Main Hose from the BISSELL website.
	Main Hose is not connected.	Locate the hose and reconnect by pushing the hose connection.
	There is a clog in the hose.	Disconnect Lower Hose and check for clogs as well. Use a broom handle to push any debris out.
	Hair wrapped around Brush Roll.	Run vacuum back and forth on clean carpet several times to release wrapped hair.
<b>Dirt is escaping from the vacuum</b>	Dirt Tank is full.	Empty the Dirt Tank.
	Filters are missing or dirty.	Check to see if all of the Pre-Motor and Post-Motor Filters are in place and clean.



<b>Hose won't pick up dirt</b>	Suction is set too low.	Adjust using the Suction Control Feature.
<b>Vacuum is hard to push or pull</b>	Suction is set too high.	Adjust using the Suction Control Feature.
<b>High-pitched noise</b>	There is a clog in the vacuum.	Check inside of Main Hose and Lower Hose for clogs by disconnecting from vacuums.

**Warning**

This content is compiled from multiple sources and is provided for reference purposes only. It may not be complete or fully applicable to all situations. If you are unable to resolve your issue, please contact the product manufacturer or an authorized service provider for official support.

