

PRODUCT DESCRIPTION

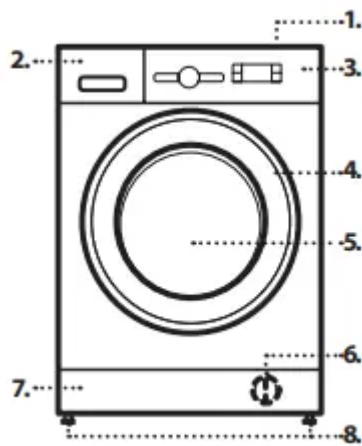

1. Worktop
2. Detergent dispenser
3. Control panel
4. Door handle
5. Door
6. Water filter - behind plinth
7. Plinth (removable)
8. Adjustable feet (4)

DETERGENT DISPENSER

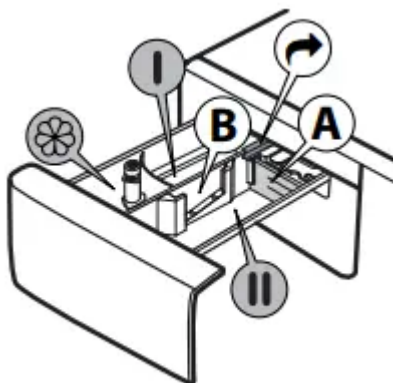

1. Main wash compartment **II**
 - Detergent for the main wash
 - Stain remover

- Water softener
- For a liquid detergent it is recommended to use removable plastic partition A (supplied) for a proper dosage. If powder detergent is used, place the partition into slot B.

2. Prewash compartment

- Detergent for the prewash

3. Softener compartment

- Fabric softener
- Liquid starch

Pour softener or starch solution only up to the “MAX” mark.

4. Release button (press to remove the detergent dispenser for cleaning)

TECHNICAL DATA FOR WATER CONNECTION

Water connection

Water supply - Cold

Water tap - 3/4” threaded hose connector

Minimum water supply pressure - 100 kPa (1 bar)

Maximum water supply pressure - 1000 kPa (10 bar)

CONTROL PANEL

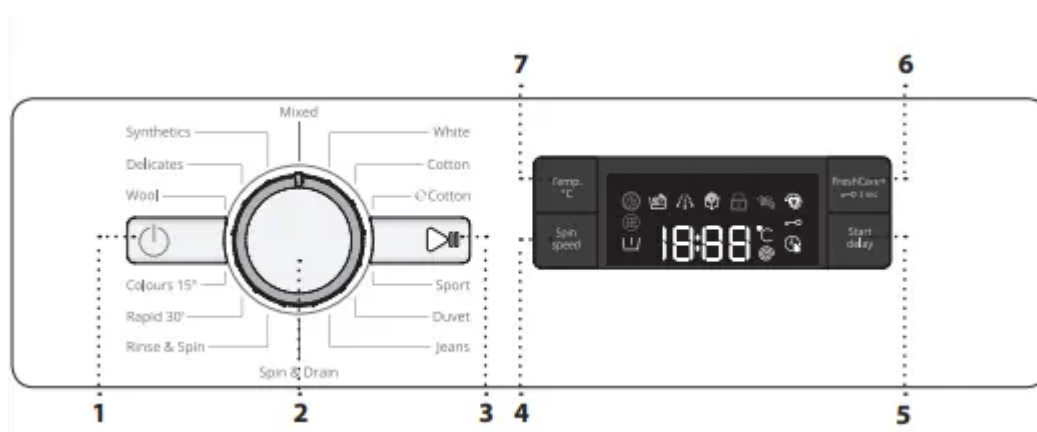

1 “ON/OFF” button 

2 Programme selector

3 “Start/Pause” button 

4 “Spin” button

5 “Start delay” button

6 “FreshCare+”/ “Key lock” button 

7 “Temperature” button

PROGRAMMES

For choosing the appropriate programme for your kind of laundry, always respect the instructions on the care labels of the laundry.

The value given in the tub symbol is the maximum temperature possible for washing the garment.

MIXED For washing lightly to normally soiled resilient garments in cotton, linen, synthetic fibres and mixed fibres.

WHITE For washing normally to heavily soiled towels, underwear, table and bed linen, etc in resilient cotton and linen. Only when the temperature is selected at 90°C the cycle is provided with a prewash phase before main washing phase. In this case it is recommended to add detergent both, in the prewash and main wash section.

COTTON Normally to heavily soiled and robust cottons .

 **COTTON** For washing normally soiled cotton garments. At 40°C and 60°C, this is the standard cotton programme and the most efficient in terms of water and energy consumption.

SPORT For washing lightly soiled sports clothing (tracksuits, shorts, etc.). For best results, we recommend not exceeding the maximum load indicated in the ,“PROGRAMME CHART”. We recommend using liquid detergent , and adding the amount suitable for half-load.

DUVET Designed for washing eiderdown padded items such as double or single duvets, cushions and anoraks. It is recommended to load such padded items in the drum with the edges folded inwards and not to exceed $\frac{3}{4}$ of the drum’s volume. For optimal washing, we recommend using a liquid detergent.

JEANS Turn garments inside-out before washing and use a liquid detergent.

SPIN & DRAIN Spins the load then empties the water. For resilient garments. If you exclude the spin cycle, the machine will drain only

RINSE & SPIN Rinses and the spins. For resilient garments.

RAPID 30' For washing lightly soiled garments quickly. This cycle lasts only 30 minutes, saving time and energy.

COLOURS 15° This cycle helps protect colours by washing in cold water (15°C) and uses less energy to heat the water while still offering satisfactory wash results. Suitable for lightly soiled, unstained garments. This cycle offers wash results comparable to 40°C mixed at just 15°C

WOOL All wool garments can be washed using programme ,“Wool“ even those carrying the “hand-wash only“ label. For best results, use special detergents and do not exceed max kg declaration of laundry.

DELICATES For washing particularly delicate garments. Preferably turn garments inside out before washing.

SYNTHETICS For washing normally soiled garments made from synthetic fibres (such as polyester, polyacrylic, viscose etc.) or cotton/ synthetic blends

OPTIONS

If the selected function is incompatible with the set programme, the incompatibility will be signalled by a buzzer (3 beeps).

If the selected function is incompatible with another previously set function the function will not be enabled.

START DELAY To set the selected programme to start at a later time, press the button to set the desired delay time. The symbol  lights on the display when this function is enabled. To cancel the delayed start, press the button again until the value "0" is shown on the display.





FRESHCARE+ This option enhances washing performance by generating steam to inhibit the proliferation of the main bad odour sources inside the machine. After steam phase, the washing machine will perform gentle tumbling through slow rotations of the drum.

FreshCare+ option starts after the cycle ends for a maximum duration of 6h and you can interrupt it at any time by pressing any button on control panel or turning the knob. Wait around 5 minutes before door can be opened.

TEMPERATURE Every programme has a predefined temperature. If you want to change the temperature, press the “temperature” button. The value appears on the display.

SPIN Every programme has a predefined spin speed. If you want to change the spin speed, press the "Spin" button. The value appears on the display.

FUNCTIONS

 **ON/OFF** To switch on the washing machine: press the "ON/OFF"  button, the “Start/ Pause”  button light up. To switch off the washing machine during the wash cycle, press and hold the button for approximately 3 seconds. If the button is pressed briefly or accidentally the machine will not switch off. To switch off the washing machine after programme end: press the “ON/OFF”  button until the lights go off.

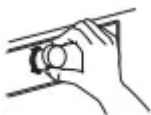

KNOB To select and confirm programmes. Turn to select.

▶ START/PAUSE To start the programme, after you have finished your settings. To pause a running programme. To continue a paused programme.

⊖ KEY LOCK To lock the control panel, press and hold the “Key lock” ⊖ button for approximately 3 seconds. The symbol ⊖ will light up on the display to indicate that the control panel has been locked (with the exception of the “ON/OFF” ⏻ button). This prevents unintentional changes to programmes, especially with children near the machine. To unlock the control panel, press and hold the “Key lock” ⊖ button for approximately 3 seconds .

BLEACHING If you wish to bleach the laundry, load the washing machine and set the “Rinse & Spin” programme. Start the machine and wait for it to complete the first water filling cycle (roughly 2 minutes). Put the machine in pause mode by pressing the “Start/Pause” ▶ button, open the detergent drawer and pour the bleach (observe the recommended doses indicated on the package) into the main wash compartment where the partition was previously mounted. Restart the cycle by pressing the “Start/Pause” ▶ button. If desired, it is possible to add fabric softener into the appropriate compartment of the detergent drawer.

DEMO MODE This function is only used for sales presentations. By this you can interact with washing machine and see it working without water. To enter Demo mode, switch the washing machine ON and OFF again. Press and hold “Start/Pause” ▶ button, then within 5 seconds press also “ON/OFF” ⏻ button and hold both buttons for 10 seconds. To deactivate this function, switch the washing machine OFF. Than press and hold “Start/Pause” ▶ button, within 5 seconds press also “ON/OFF” ⏻ button and hold both buttons for 2 seconds.

PROGRAMME CHART

Max. load 7 Kg						Detergents and additives			Recommended detergent	
Programme	Temperatures		Max. spin speed (rpm)	Max. load (kg)	Duration (Minutes)	Prewash	Main wash	Softener	Powder	Liquid
	Default	Range				⏻	⏻	⊗		
Mixed	40°C	⊗ - 40°C	1000	3.5	**	–	●	○	–	✓
White	60°C	⊗ - 90°C	1200	6.5	**	● (90°)	●	○	✓	✓
Cotton	40°C	⊗ - 60°C	1200	6.5	230	–	●	○	✓	✓
⊖ Cotton	60°C	50°- 60°C	1200	6.5	175	–	●	○	✓	✓
		40°C	1200	7.0	290	–	●	○	✓	✓
		⊗ - 30°C	1200	6.5	290	–	●	○	✓	✓
Sport	40°C	⊗ - 40°C	600	3.5	**	–	●	○	–	✓
Duvet	30°C	⊗ - 30°C	1000	2.0	**	–	●	○	–	✓
Jeans	40°C	⊗ - 40°C	800	3.5	**	–	●	○	–	✓
Spin & Drain	–	–	1200	7.0	**	–	–	–	–	–
Rinse & Spin	–	–	1200	7.0	**	–	–	○	–	–
Rapid 30'	30°C	⊗ - 30°C	800	3.0	**	–	●	○	–	✓
Colours 15°	15°C	15°C	1000	3.5	**	–	●	○	–	✓
Wool	40°C	⊗ - 40°C	800	1.5	**	–	●	○	–	✓
Delicates	30°C	⊗ - 30°C	–	1.0	**	–	●	○	–	✓
Synthetics	40°C	⊗ - 60°C	1200	4.0	195	–	●	○	✓	✓

● Dosing required ○ Dosing optional

DOOR

To open the door, pull the handle.



To close the door, hold the handle and push so that you can hear it click shut.



ACCESSORIES

Contact our After-Sales Service to check if the following accessories are available for your washing machine (and dryer) model

STACKING KIT SHELF

By which your dryer can be fixed on top of your washing machine to save space and to facilitate loading and unloading your dryer in the higher position.

HOW TO USE THE APPLIANCE

FIRST TIME USE

Remove any manufacturing debris:

- Select the “Cotton” programme at a temperature of 60°C.
- Pour a small quantity of detergent powder into the main wash compartment **II** of the detergent dispenser maximum 1/3 of the quantity the detergent manufacturer recommends for lightly soiled laundry).
- Start the programme without adding any laundry (with empty drum).
- See section “DAILY USE” for more information on how to select and start a programme.

DAILY USE

PREPARING THE LAUNDRY



Empty pockets

- Coins, paper clips, etc. could damage the load and the washing machine components.
- Tissues will break down during the wash cycle, and the fragments will have to be subsequently removed by hand.



Close all zippers, buttons, and hooks. Tie all ribbons or belts

- Insert the smaller garments (e.g. nylon hosiery, belts, etc.) and garments with hooks (e.g. braziers) into a fabric bag or a pillowcase with a zipper. Remove any rings from curtains, or else place the curtains inside a fabric bag together with the rings.

Fabric type / Symbol on the wash label

- Cottons, mixed fibres, easy care/synthetics, wool, handwash items.
- Colour

Separate coloured and white items. Wash new coloured articles separately.

- Size

Wash items of different sizes in the same wash load, to improve washing efficiency and distribution of the articles in the drum.

- Delicates

Wash delicate items separately; they require gentle treatment.

HOW TO USE THE WASHING MACHINE

1. Load laundry



Open the door and load the laundry. Load the articles one at a time loosely into the drum, without overfilling. Observe the load sizes given in the " PROGRAMME CHART" table. Overloading the machine will result in unsatisfactory washing results and creased laundry

2. Close door



Make sure that no laundry gets stuck between door glass and rubber seal.

Close the door so that you can hear it click shut

3. Open water tap



Make sure that the washing machine is connected to the water mains. Open the water tap.

Switch on washing machine

Press the “ON/OFF” , the “Start/Pause”  lamp flashes slowly.

4. Set the desired programme

Select the required programme with the “Programme selector” dial. The duration of the wash cycle is shown on the display. The washing machine automatically displays the maximum temperature and spin speed settings possible for the selected programme. Adjust the temperature and/or spin speed settings if needed with the relative buttons.

Change temperature, if needed: Press the “Temperature” button to progressively lower the temperature setting until cold wash has been set (“-” will be shown on the display).

Pressing the button again sets the highest possible setting.

Change spin speed, if needed: Press the “Spin” button to progressively decrease the spin speed until the spin cycle is turned off (“0” will be shown on the display). Pressing the button again sets the highest possible setting.

Select options, if needed: Press the button to select the option; the respective symbol on display illuminates. Press the button again to cancel the option; the light extinguishes.

- If the selected option is incompatible with the programme set, the incompatibility will be signalled by a buzzer (3 beeps) and the corresponding indicator light will flash.
- If the selected option is incompatible with another previously set option, only the most recent selection will remain active.

5. Add detergent



Pull out the detergent dispenser and add detergent (and additives/softener) into the relative compartments as described in section “DETERGENT DISPENSER”. Observe the dosing recommendations on the detergent pack.



Correct dosing of detergent / additives is important, because:

- it optimizes the cleaning result
- it avoids irritating residues of surplus detergent in your laundry
- it saves money by avoiding waste of surplus detergent
- it protects the washing machine by avoiding calcification of components
- it respects the environment by avoiding unnecessary environmental burden.

6. Delaying the start of a programme

To set a programme to start at a later time, see the section “OPTIONS/ START DELAY”



7. Start programme

- Press the “Start/Pause”  . The relative indicator lamp illuminates, the door locks and the “Door locked”  indicator lights up.
- To avoid overflow, do not open the detergent dispenser during a running programme anymore.
- The remaining programme duration can vary. Factors like unbalance in the wash load, or foam formation, can have an effect on the programme duration.

8. Change the settings of a running programme, if needed

You can still change the settings while a programme is running. The changes will be applied, provided the respective programme phase has not finished yet.



To change the settings of a running programme:

- Press “Start/Pause”  to put the running programme on pause.
- Change your settings.
- Press “Start/Pause”  again to continue the programme.

If you have changed the programme, do not add detergent for the new programme.

To prevent that a running programme is changed by accident (for instance by children), use the “Key lock”  (see section FUNCTIONS”).

Pause a running programme and open the door, if needed



- Press “Start/Pause”  to pause a running programme.
- Provided water level or temperature is not too high, the “Door locked”  indicator light turns off. You can open the door, for example to add more laundry, or to remove laundry which was loaded by mistake.
- Press “Start/Pause”  to proceed with the programme.

9. Cancelling a running programme, if needed

- Press and hold the “ON/OFF”  button until the washing machine stops.
- If the water level and temperature are low enough, the door unlocks and may be opened.
- The door remains locked if there is water in the drum. To unlock the door, switch the washing machine on, select the “Spin & Drain” programme and turn the spin option off by setting the spin speed to “0”.
- The water is emptied and the door unlocks at the end of the programme.









10. Switch off the washing machine after programme End

- At the end of the cycle, the message “END” is shown on the display.

- The door can only be opened when the symbol “Door locked”  light turns off.
- Check that the “Door locked”  indicator is off, then open the door and take out the laundry.
- Press “ON/OFF”  to switch the washing machine off.

To save energy, if the washing machine is not switched off manually with the button, it turns off automatically approximately 30 minutes after the end of the programme. Leave the door ajar to let the interior of the washing machine to dry.

DISPLAY INDICATORS

	Door locked	This indicator will light up: <ul style="list-style-type: none"> • after you have started a programme • the porthole door is locked
	FreshCare+	This indicator will light up: <ul style="list-style-type: none"> • after you set the Freshcare+ option
	Start delay	This indicator will light up: <ul style="list-style-type: none"> • after you set the Start delay option
	Key lock	This indicator will light up: <ul style="list-style-type: none"> • after you set the Key lock option
	Washing phase indicator	This indicator shows the current programme phase, running from left to right through wash, rinse and drain. The illuminated indicator light shows which phase is in progress.
	Call Service	Failure: Call After-sales service <ul style="list-style-type: none"> • Refer to Troubleshooting section • If the indicator persist, call After-sales service
	Water filter clogged	Failure: Water filter clogged <ul style="list-style-type: none"> • Water cannot be drained; water filter might be blocked
	No water	Failure: No water <ul style="list-style-type: none"> • No or not sufficient inlet water.

HINTS AND TIPS

RULES FOR SEPARATING LAUNDRY

- Fabric type / indications on label (cotton, mixed fibres, synthetic, wool, handwash items)
- Colour (separate coloured garments from whites, wash new coloured items separately)
- Size (wash items of different sizes in the same load to improve washing efficacy and weight distribution in the drum)
- Delicates (place small items – such as nylon stockings – and garments with clasps – such as braziers – in a laundry bag or in a pillow case with a zip).

WASH SYMBOLS ON GARMENT LABELS

The value given in the tub symbol is the maximum temperature possible for washing the garment.

 Normal mechanical action

 Reduced mechanical action

 Much reduced mechanical action

 Hand wash only

 Do not wash

CLEAN THE WATER FILTER REGULARLY

- This is needed to prevent the filter from blocking and preventing the water from draining correctly.

SAVING ENERGY AND PROTECTING THE ENVIRONMENT

- Keeping within the load limits indicated in the "PROGRAMM CHART" will optimise energy, water and detergent consumption and reduce washing times.
- Do not exceed the detergent quantities recommended by the detergent manufacturer.
- Save energy by using a 60 °C instead of a 90 °C wash programme, or by using a 40 °C instead of a 60 °C wash programme. We recommend using the "e Cotton" the 60 °C programme for cotton garments, which is longer, but uses less energy.
- To save energy and time when washing, select highest spin speed available for the programme to reduce the residual water remaining in the garments at the end of the wash cycle.
- Pretreat any stains with an appropriate stain remover, or else dampen any dried-on stains with water prior to washing, as this will reduce the need to use a high temperature wash programme.
- Use the "Colours 15°" programme for lightly soiled coloured garments; this will reduce the amount of energy used to heat the water.

CLEANING & MAINTENANCE

For any cleaning and maintenance, switch off and unplug the washing machine.

Do not use flammable fluids to clean the washing machine.

CLEANING THE OUTSIDE OF THE WASHING MACHINE

Use a soft damp cloth to clean the outer parts of the washing machine.

Do not use glass or general purpose cleaners, scouring powder or similar to clean the control panel – these substances might damage the printing.

CHECKING THE WATER SUPPLY HOSE

Check the inlet hose regularly for brittleness and cracks. If damaged, replace it by a new hose available through our After-Sales Service or your specialist dealer.

Depending on the hose type:

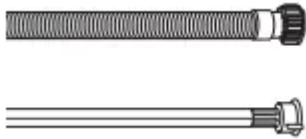

If the inlet hose has a transparent coating, periodically check if the colour intensifies locally. If yes, the hose may have a leak and should be replaced.

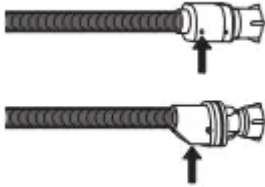

For water stop hoses: check the small safety valve inspection window (see arrow). If it is red, the water stop function was triggered, and the hose must be replaced by a new one. For unscrewing this hose, press the release button (if available) while unscrewing the hose.

CLEANING THE MESH FILTERS IN THE WATER SUPPLY HOSE

1. Close water tap and unscrew the inlet hose.

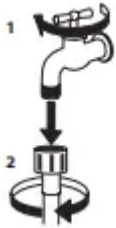

2. Clean the mesh filter at the hose's end carefully with a fine brush.



3. Now unscrew the inlet hose on the back of the washing machine by hand. Pull out the mesh filter from the valve on the back of the washing machine with pliers and carefully clean it.

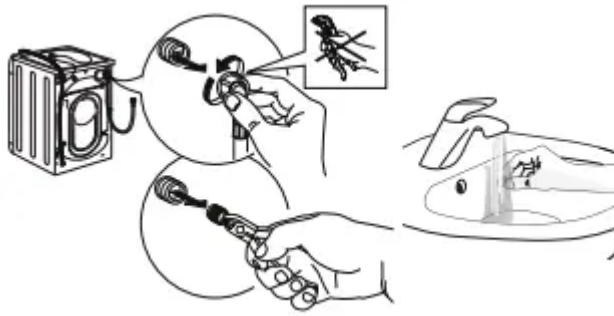

4. Insert the mesh filter again. Connect the inlet hose to water tap and washing machine again. Do not use a tool to connect the inlet hose. Open the water tap and check that all connections are tight.

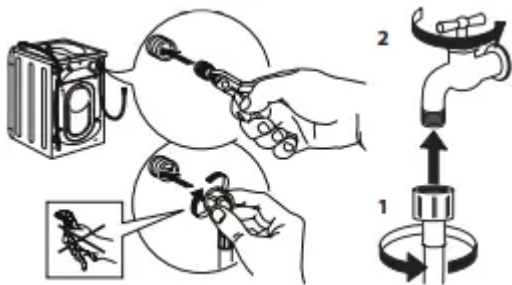

CLEANING THE DETERGENT DISPENSER

1. Remove the detergent dispenser by pressing on the release button and at the same time pulling out the detergent dispenser.

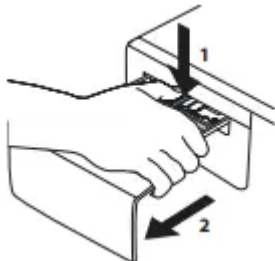

2. Remove the insert from the softener compartment.

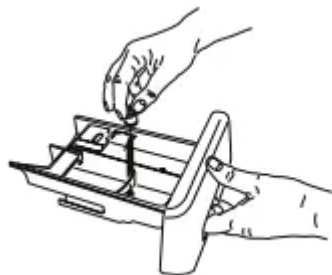

3. Clean all parts under running water, removing all detergent or softener residues.

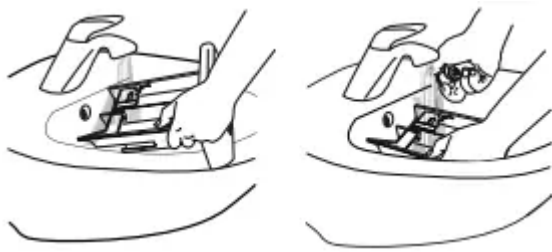

4. Wipe the parts dry with a soft cloth.



5. Reinstall the detergent dispenser and push it back into the detergent compartment.

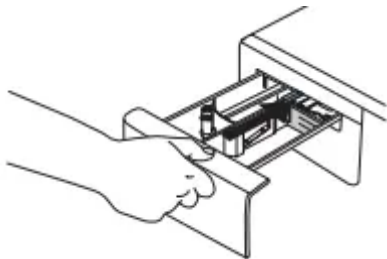

CLEANING THE WATER FILTER / DRAINING RESIDUAL WATER

Switch off and unplug the washing machine before cleaning the water filter or draining residual water. If you used a hot wash programme, wait until the water has cooled down before draining any water.

Clean the water filter regularly, to avoid that the water cannot drain after the wash due to obstruction of the filter. If the water cannot drain, the display indicates that the water filter may be clogged.

1. Remove the kick panel: Using a screwdriver, do that which is shown in the following figure.

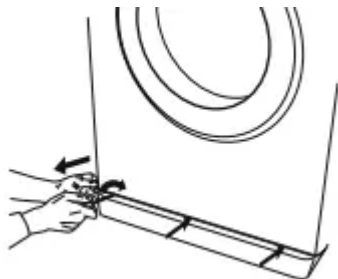

2. Container for the drained water:

Place a low and wide container under the water filter in order to collect the residual water.



3. Drain the water:

Slowly turn the filter counter-clockwise until all the water has come out. Allow the water to flow out without removing the filter. Once the container is full, close the water filter by turning it clockwise. Empty the container. Repeat the procedure until all the water has been drained.

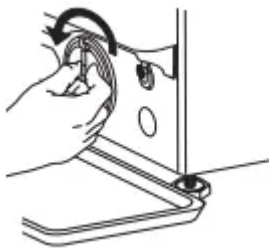

4. Remove filter: Lay a cotton cloth beneath the water filter, which can absorb a small amount of rest water. Then remove the water filter by turning it out anticlockwise.

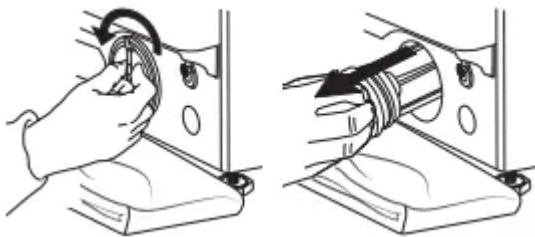

5. Clean the water filter: remove residues in the filter and clean it under running water.



6. Insert the water filter and reinstall the plinth: Reinsert the water filter again by turning it in clockwise direction. Make sure to turn it in as far as it goes; the filter handle must be in vertical position. To test water tightness of the water filter, you can pour about 1 liter of water into the detergent dispenser. Then reinstall the plinth.

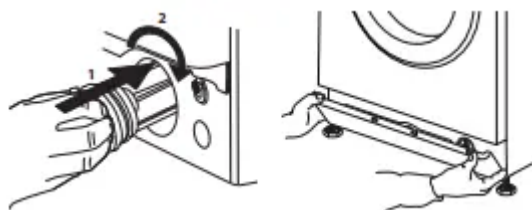

TROUBLESHOOTING



Your washing machine is equipped with various automatic safety and feedback functions. They enable failures and needed maintenance to be detected and indicated accordingly.

These failures are frequently so minor that they can be removed within a few minutes.

The washing machine does not turn on.

- The plug is not inserted into the electrical outlet, or not enough to make contact.
- There has been a power failure.
- The door is not fully closed.

The wash cycle does not start.

- The “ON/OFF” button  has not been pressed.
- The “Start/Pause” button  has not been pressed.
- The water tap is not open.
- A “Start delay” has been set.

The washing machine does not fill with water (the message “h2o” is shown on the display). “Beep” sound every 5 seconds.

- The water intake hose is not connected to the tap.
- The hose is bent.
- The water tap is not open.
- The mains water supply has been shut off.
- There is not enough pressure.

The washing machine loads and drains water continuously.

- The “Start/Pause”  button has not been pressed.
- The drain hose has not been installed at 65 to 100 cm from the ground.
- The end of the drain hose is immersed in water.
- The drain connector on the wall does not have an air vent.
- If the problem persists after having performed these checks, close the water tap, shut off the washing machine, and call the After-sales service. If the dwelling is located on one of

the uppermost floors of a building, a siphon effect can sometimes occur, thus causing the washing machine to load and drain water continuously. Special anti-siphon valves are available on the market to prevent these types of problems.

The washing machine does not drain or does not spin.

- The programme does not include the draining function: with certain programmes it must be activated manually.
- The drain hose is bent.
- The drain line is obstructed.

The washing machine vibrates excessively during the spin cycle.

- At the time of installation, the drum was not properly unblocked.
- The washing machine is not level.
- The washing machine is squeezed between furniture and the wall.

The washing machine leaks water.

- The water intake hose has not been tightened properly.
- The detergent dispenser is clogged.
- The drain hose has not been properly fastened.

The machine is locked and the display flashes, indicating an error code (e.g. F-01, F-..).

- Shut off the machine, disconnect the plug from the outlet, and wait about 1 minute before turning it back on.
- If the problem persists, call the After-sales service.

Too much foam is formed.

- The detergent is not compatible with the washing machine (it must bear the wording “for washing machines”, “for hand washing and washing machines”, or something similar).
- The dosage was excessive.

Door is locked, with or without failure indication, and the programme does not run.

- Door is locked in case of power breakdown. Programme will continue automatically as soon as the mains is available again.
- Washing machine is in a standstill. Programme will continue automatically after the origin of the standstill does not persist anymore.

Warning

This content is compiled from multiple sources and is provided for reference purposes only. It may not be complete or fully applicable to all situations. If you are unable to resolve your issue, please contact the product manufacturer or an authorized service provider for official support.

Document generated by [ManualsFile](#)

