

Introduction

Symbol used in this manual

Note: Indicates special notes and operating features.

Caution: Indicates cautions for preventing possible damages from abuse.

Caution: Water-proof (IPX5)

This speaker is water-proof according to IPX5. IPX5 is “Degrees of protection against ingress of water” However, this system is not completely water-tight. Avoid the cases below.

- Do not use unit under water or other liquid.
- When battery is charging, do not expose the unit to water.
- When port is exposed to water, wipe off it with a soft dry cloth. Thoroughly dry it before using the speaker.
- Ports are not water-proof. Make sure close the port cover securely. Refer to below image.

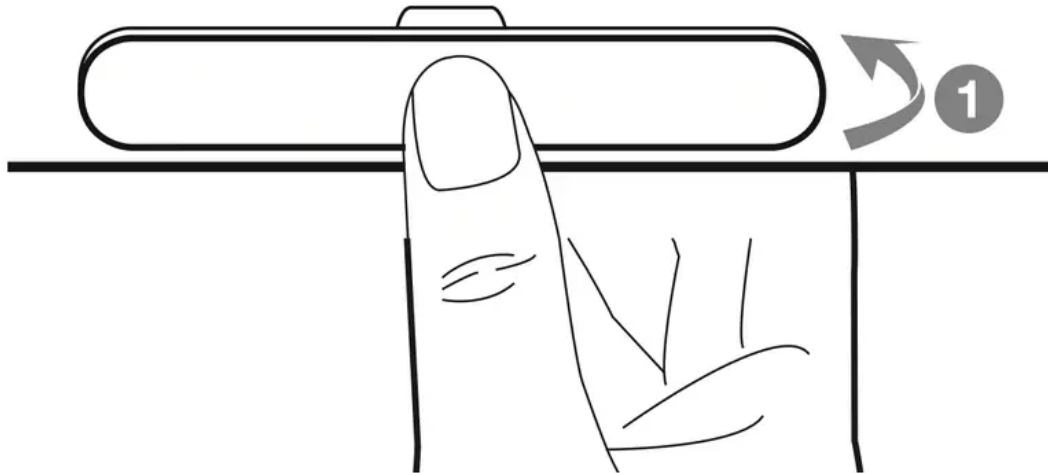

- Position port cover onto **1** and securely press it.

The water resistant performance of the system is based on our measurements under the conditions herein described. Note that malfunctions as a result of water immersion caused by misuse by the customer are not covered by the warranty.

Front

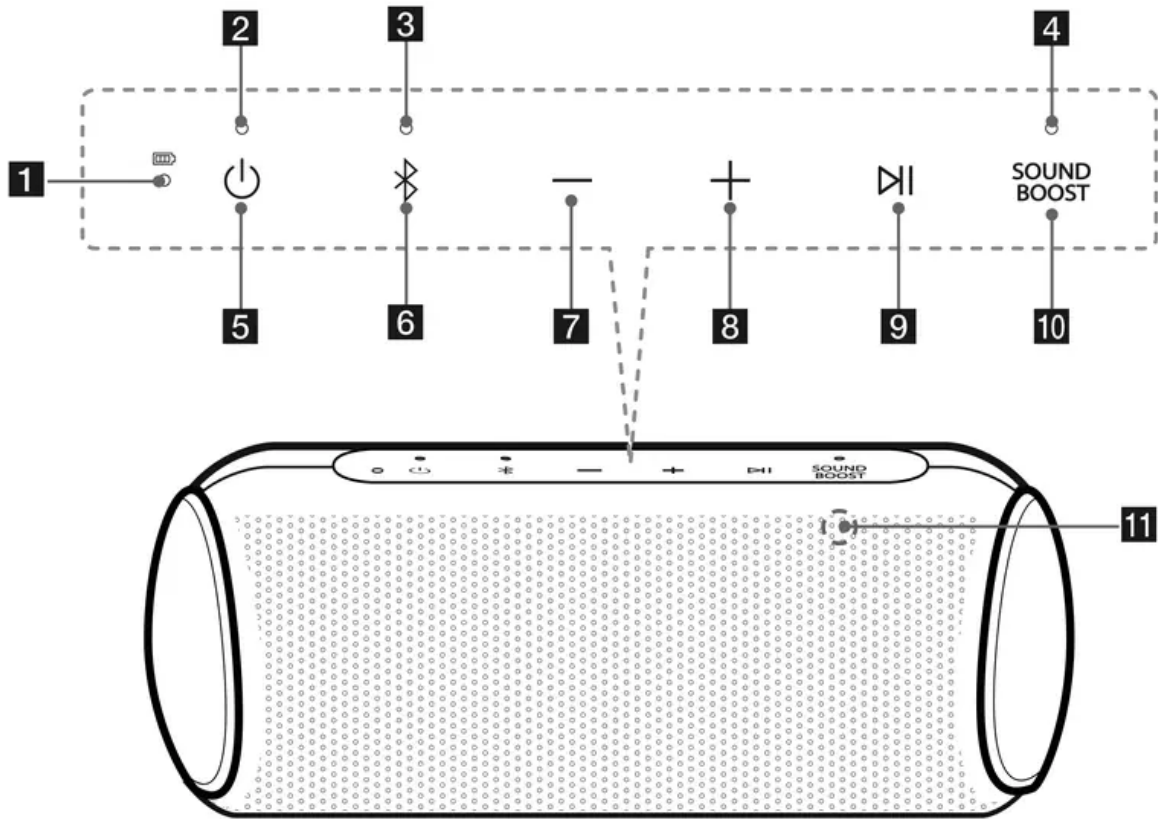



1. Battery LED
2. Power LED
3. Bluetooth LED
4. SOUND BOOST LED
5. 

Turns On / Off: Press it.

* If the power turned on, you can check the battery status by pressing the  button for 2 seconds.

6. 

Adds a Bluetooth device for multi phone pairing. (Press and hold  for 2 seconds)

Changes to Bluetooth mode in AUX mode. (Press )

* When you connect the 3.5 mm stereo cable, the function is changed to AUX mode.

Press and hold  for 7 seconds for Bluetooth Initialization.



7. —

Turn down the volume.

8. +

Turn up the volume.

9. 

Plays, pauses or skips playback on the Bluetooth mode. (Page 12)

Receives a call on the Bluetooth device. (Page 14)

Mutes the sound on the AUX mode.

Use voice command of your smart device. Press and hold the  button for 2 seconds to use voice command.

10. **SOUND BOOST**

Changes sound effect. (Page 17)

11. Microphone

Rear

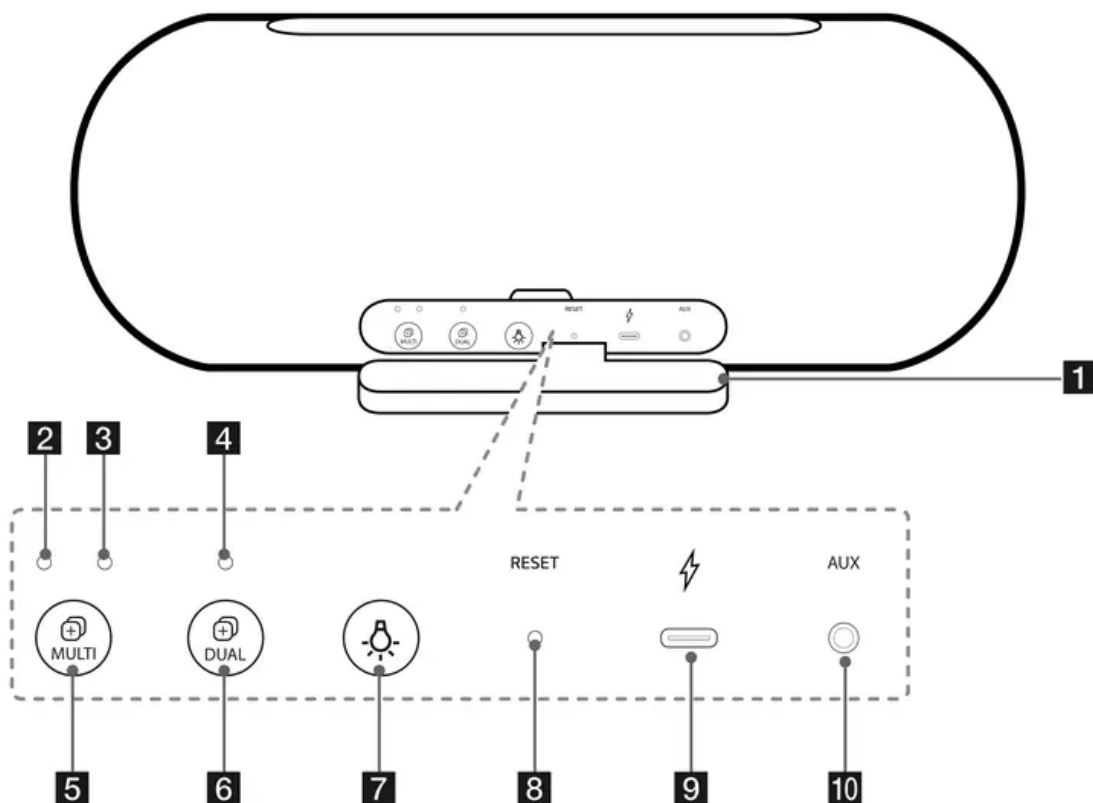

1. Port cover

2. Multi Mode LED (MAIN)

3. Multi Mode LED (OTHER)

4. Dual Mode LED

5.  **MULTI**

Connects multiple speakers for Multi Mode. (Page 28-29)

6.  **DUAL**

Connects two speakers for Dual Mode.

7. 

Changes mood light. (Page 16)

8. **RESET** button

9.  (DC IN)

USB (C type) port for charging

10. **AUX**

Listens to music from your portable device.

Basic Operations

Using power button

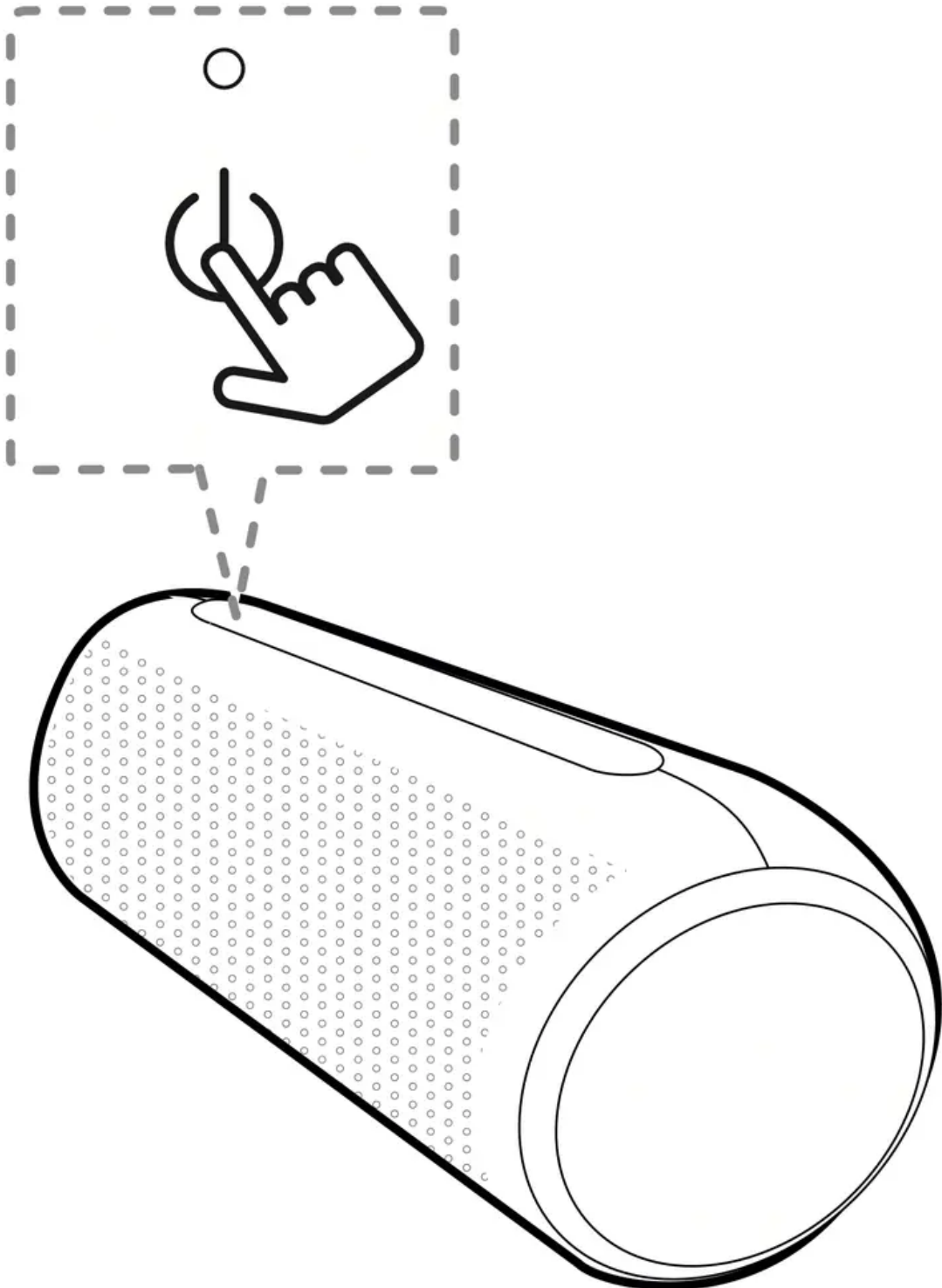

Power On / Off

Press the  button.

Bluetooth Connection

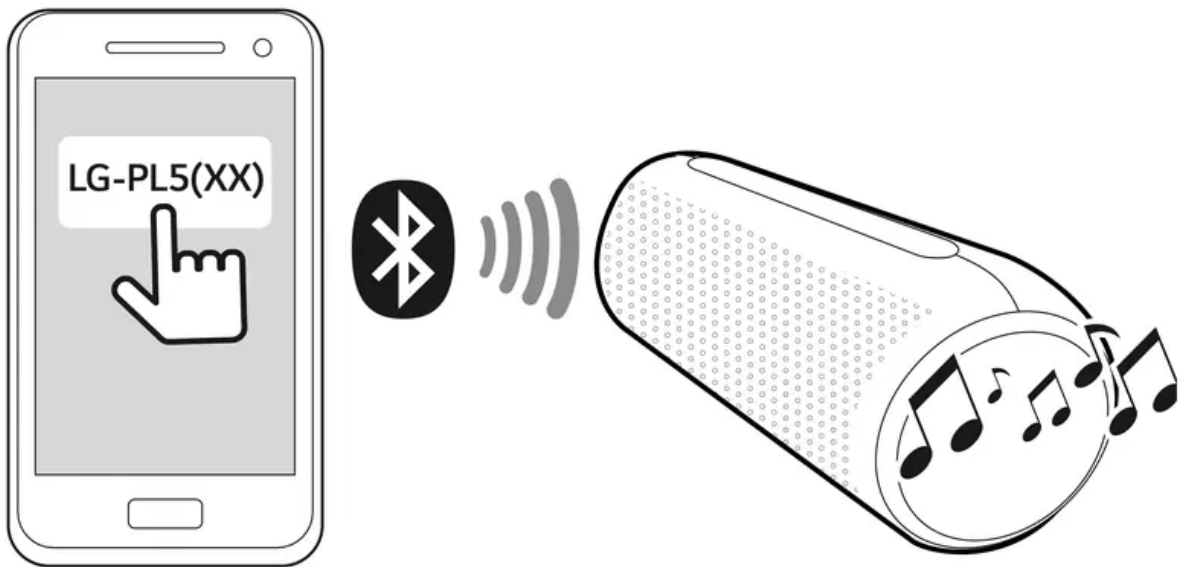



Play the desired music on the Bluetooth device. After pairing, you can control playback using the buttons on the unit. (Page 12-13, 19-21)

Bluetooth LED status

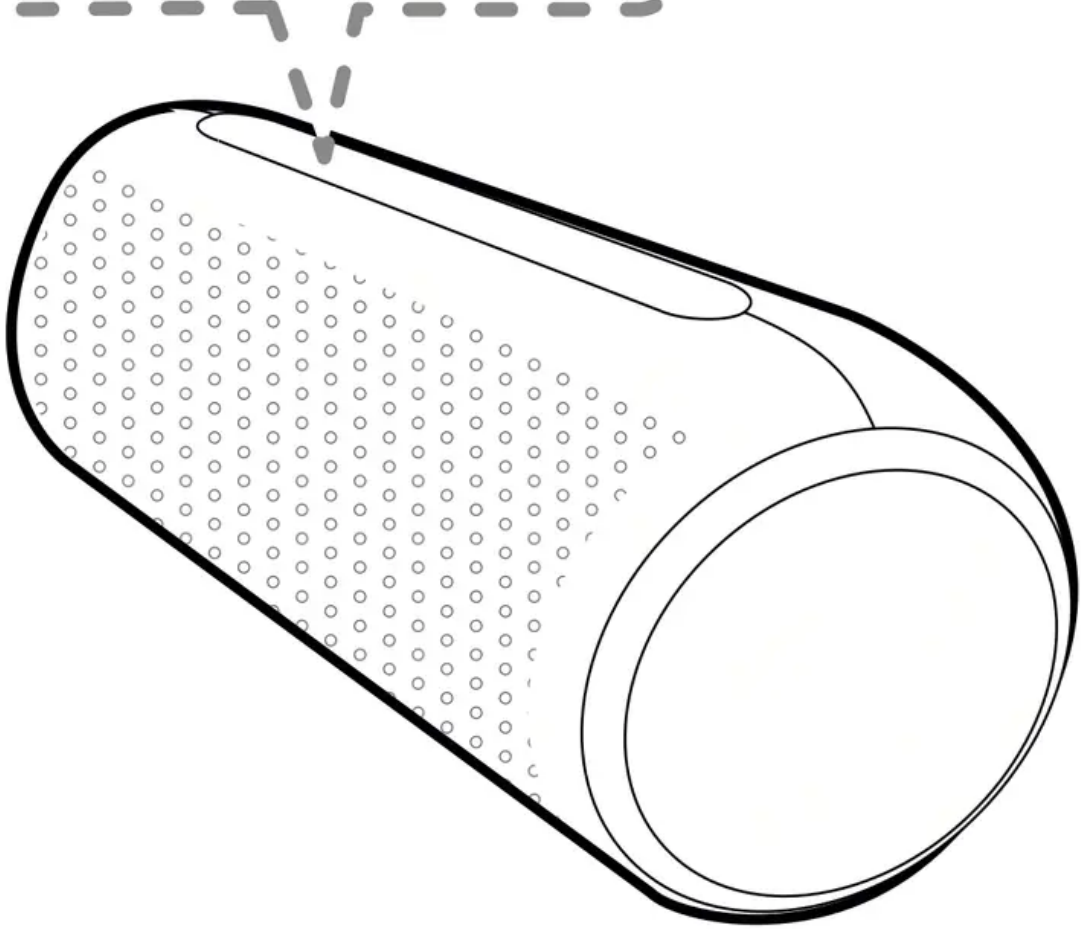
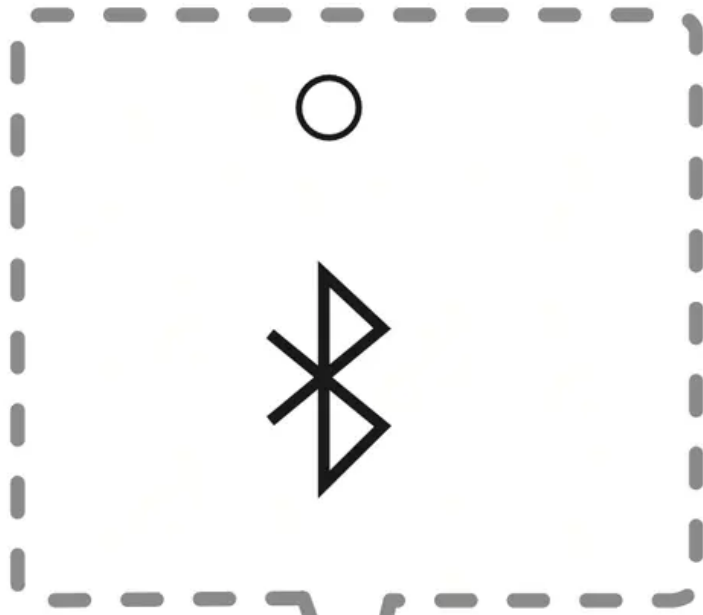
Check the Bluetooth LED blinks before connecting Bluetooth device.















LED	Status	Description
	Bluetooth LED blinks with the sound.	Searching for Bluetooth device.
	Bluetooth LED turns on with the sound.	Bluetooth device is connected.





Note

- In AUX mode, Bluetooth LED turns off.
- Once pairing is performed, it does not need to be done again even if you turn off this unit.
- When switching AUX mode to Bluetooth mode, Bluetooth LED turns on but there is no sound.



Simple Operation Guide

Function	How to	Status
Power On	Press the  button.	Power LED turns on with the sound.
Power Off	Press the  button.	Power LED turns off with the sound.
Bluetooth pairing	When Bluetooth LED blinks, select LG-PL5 (XX) from device list on your Bluetooth device.	Bluetooth LED turns on with the sound.
Multi phone pairing	Press and hold  for 2 seconds to add another Bluetooth device.	During the search for another device, the Bluetooth LED blinks. After pairing, Bluetooth LED stays in white with the sound.
Volume control	Press  or  .	When this unit reaches minimum volume or maximum volume, you can hear beep sound.
Play / Pause	Press  .	-
Forward skip	Press  twice.	-
Backward skip	Press  three times.	-
Handsfree	Press  .	Receive and disconnect a call.
Voice Command	Press and hold  for 2 seconds	You can speak to operate the voice command of your smartphone through speaker's microphone
Mood light	Press the  .	When you press the  button, the mood light settings will be changed.
Sound effect	Press SOUND BOOST to select Standard or SOUND BOOST.	When you press the SOUND BOOST button, the sound effect is changed. LED Off is Standard and LED On is SOUND BOOST.

Function	How to	Status
Dual Mode	Press the  DUAL button.	Dual Mode LED of the Main speaker turns on with the sound. And then Dual Mode LED of the Other speaker turns on with the sound.
Multi Mode	Press the  MULTI button. And then press  MULTI repeatedly to select MAIN or OTHER.	After selecting Main or Other, the speakers is connected with beep sound after 3 seconds.
Bluetooth Initialization	Press and hold  for 7 seconds.	Power and Bluetooth LED blinks 4 times.

Note

- In Dual Mode and Multi Mode, the multi phone pairing connection is not supported. (Page 26-29)
- Main speaker turns on Left Multi Mode LED and Bluetooth LED on Multi Mode

- Other speaker turns on Right Multi Mode LED on Multi Mode. And Bluetooth LED turns off.
- You can adjust playback or volume by using your Bluetooth device.
- After initializing Bluetooth, it needs to reconnect with Bluetooth device. (In case of iOS devices, try to reconnect with Bluetooth device after deleted existing connection on Bluetooth device.)

Handsfree Function

You can receive incoming call on your Bluetooth device to this unit. Connect the unit to a Bluetooth device.

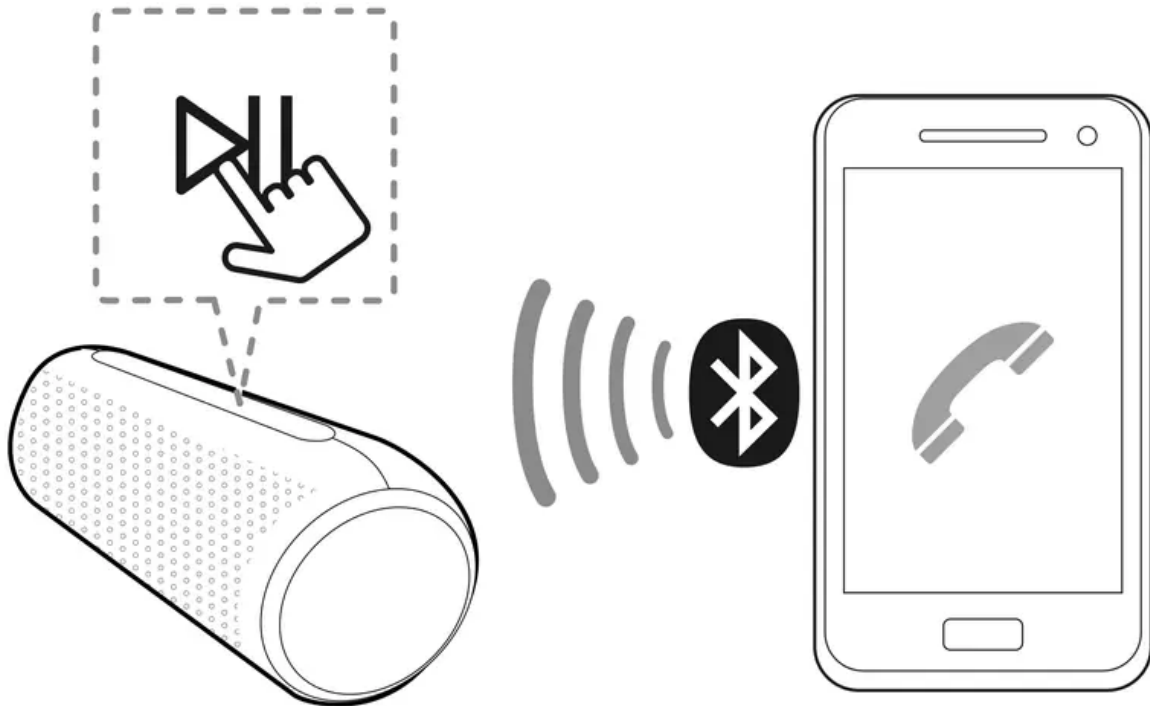

Function	How to
Receive a call.	Press ▶ .
End the call.	Press ▶ .
Reject a call.	Press and hold ▶ for 2 seconds
Toggle between speaker and your phone during a call.	Press and hold ▶ for 2 seconds

Note

- During Handsfree Function, Voice Command is not supported.
- Only smartphone is available to use this function.
- To adjust the call volume, press **—**, **+** buttons on the unit.
- In Dual Mode and Multi Mode, you can receive a call on only main speaker due to audio howling. (Page 26-29)
- On some Bluetooth devices, when an incoming call is received, it might ring the built-in ringtone, (ex. iOS devices) The Built-in ringtone is not adjustable.
- In multi phone pairing mode, you can only receive the call of one of the connected devices on the speaker.
- If a call is connected between multi paired Bluetooth device, hands free does not work correctly.
- Even if you switch to AUX mode while in Bluetooth connection status, you can still use this function.
- When you receive a call by using the talk button on your phone, the call will be connected to your phone. If you want to talk via the speaker, It will need to be changed to speaker mode on your phone. (Only iOS devices)
- If you do not want to use this function, disable the Bluetooth setting on your phone. Connect Bluetooth again to use this mode.

Voice Command

You can speak to operate the voice command of your smartphone through speaker's microphone by using the voice command app or the Siri.

Note: Make sure use the smart device that has voice command.



1. Connect the speaker to smart device through Bluetooth.
2. Press and hold the  button 2 seconds to active voice command of your smart device.
3. Activate voice command app as follow.
Android O/S: Select the voice command app.
iOS O/S: Siri activates automatically.
4. Make a request to voice command app or Siri through microphone of speaker.

Note

- During Handsfree Function, Voice Command is not supported.
- When voice command time limit exceeded on smart devices, this function automatically cancel.
- It is recommended that you use the Google app (Google Assistant, Google Now etc.) when enjoying this function by using Android device. Google app is provided by Google. Some of location may not support by Google Policy.
- If you want to cancel Voice command mode, press and hold the  button 2 seconds again when this function is activating.
- For more information, refer to voice command app or Siri.
- Speaking at near microphone will increase the success rate.
- It may not work depending on the Bluetooth device.

Mood light

You can turn on mood light on this unit. When you press the  button, the mood light settings will be appeared in the order as below.

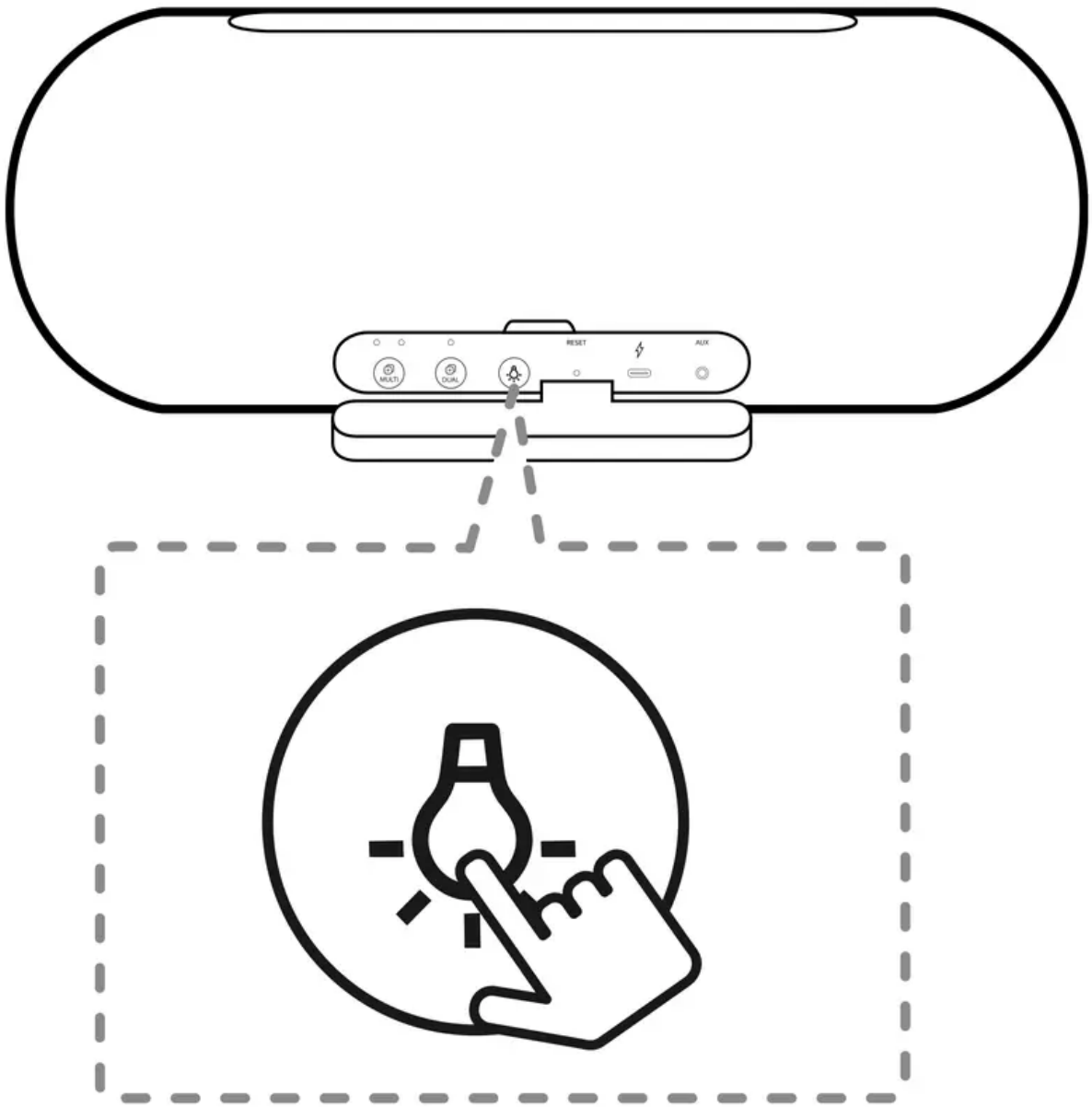

Function	Description
Party	Various colors light turns on.
Water	Blue tone light turns on.
Forest	Yellow tone light turns on.
My style	To enable My Style option, you have to customize with "LG XBOOM" app.
Off	Mood light turns off.

Note

- If you play the music, Mood light is synchronized to the music.
- When you turn the speaker back on, the last used option will be on.

Sound Effect

Sound Effect is optimally tuned in UK's high-end audio company MERIDIAN. MERIDIAN technology provides wide sound field and powerful sound.

You can select a desired sound effect by using SOUND BOOST button.



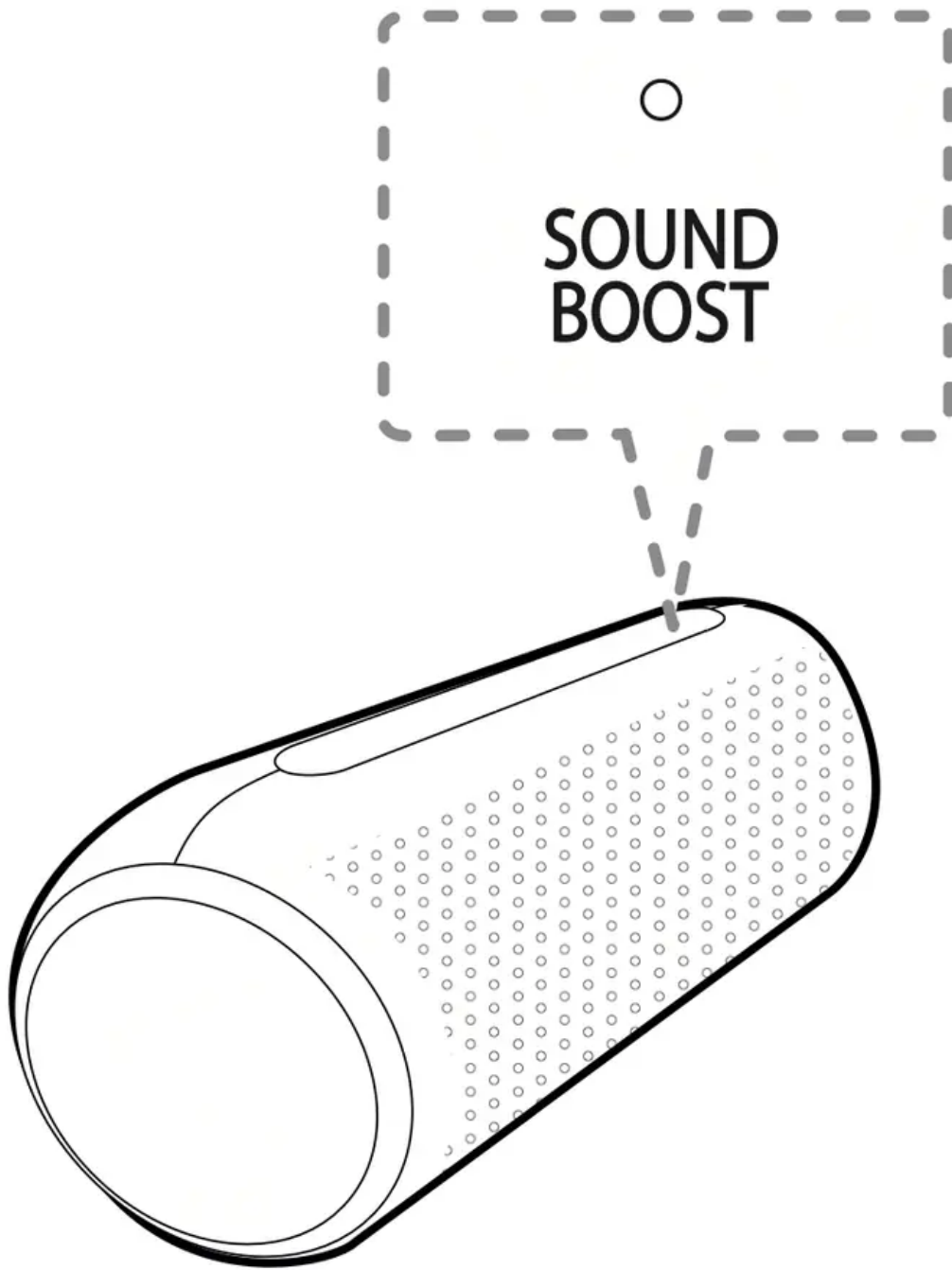

Setting Sound effect

LED	Function	Description
○ SOUND BOOST	Standard	You can enjoy High-fidelity sound with balanced and natural.
● SOUND BOOST	SOUND BOOST	You can enjoy the wide sound field and powerful sound.

Note

- When you turn the speaker back on, the last used option will be on.
- You can adjust sound effect using “LG XBOOM” app.
- When you select “Standard” sound effect, you can enjoy premium sound with MERIDIAN. y Because fine-tune sound to provide optimal high-quality sound, It might be a little difference between sound effect modes.

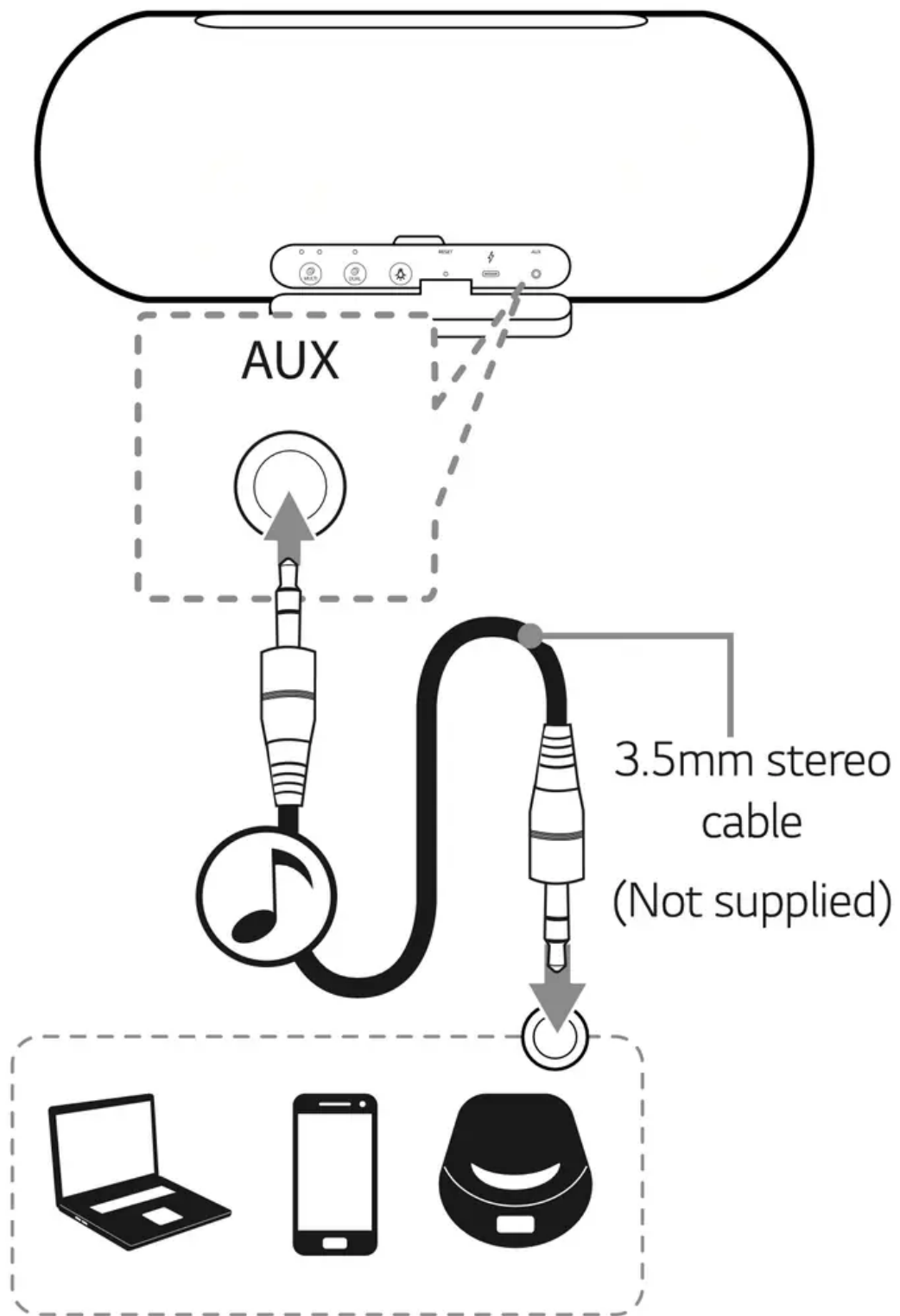

Listening to Music from Your External Device

The unit can be used to listen to the music from many types of external device.



1. Turn the power on by pressing  button.
2. Connect the external device to the AUX (3.5mm) connector of the unit.
3. Turn the external device on and start playing.

Note

- When you connect the 3.5 mm stereo cable, the function is changed to AUX mode automatically.
- In AUX mode, speaker limits Bluetooth connection to prevent unintended Bluetooth connection.
-  When the  button is pressed during this mode, it will switch to Bluetooth mode.
- When you use Dual Mode and Multi Mode, the AUX mode is not supported.

Using BLUETOOTH® wireless technology

About BLUETOOTH

Bluetooth is wireless communication technology for short range connection.

The sound may be interrupted when the connection interfered by the other electronic wave or you connect the Bluetooth in the other rooms.

Connecting individual devices under Bluetooth wireless technology does not incur any charges.

A mobile phone with Bluetooth wireless technology can be operated via the Cascade if the connection was made via Bluetooth wireless technology.

- Available Devices: Smart phone, Notebook, etc.
- Version: 5.0
- Codec: SBC, AAC

BLUETOOTH Profiles

In order to use Bluetooth wireless technology, devices must be able to interpret certain profiles. This unit is compatible with following profile.

A2DP (Advanced Audio Distribution Profile) HFP (Handsfree Profile)

AVRCP (A/V Remote Control Profile)

Listening to music stored on the BLUETOOTH devices

Pairing your unit and BLUETOOTH device

Before you start the pairing procedure, make sure the Bluetooth feature is turned on in to your Bluetooth device. Refer to your Bluetooth device’s user guide. Once a pairing operation is performed, it does not need to be performed again.

1. Turn on the unit then Bluetooth LED blinks with the sound.

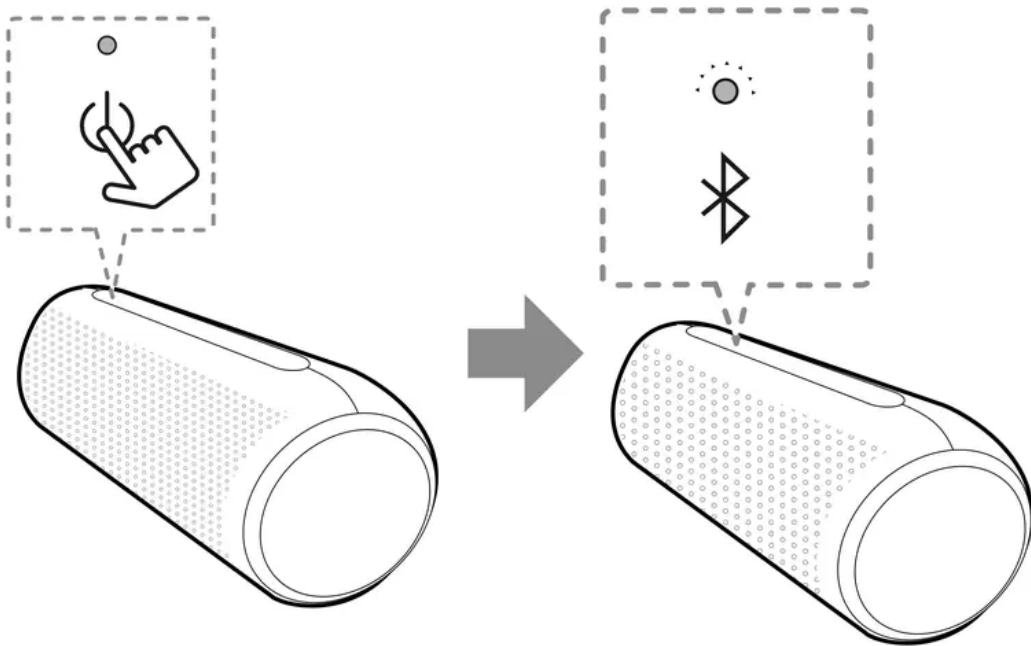

2. Operate the Bluetooth device and perform the pairing operation. When searching for this unit with the Bluetooth device, a list of the devices found may appear in the Bluetooth device display depending on the type of Bluetooth device. Your unit appears as “LG-PL5 (XX)”.

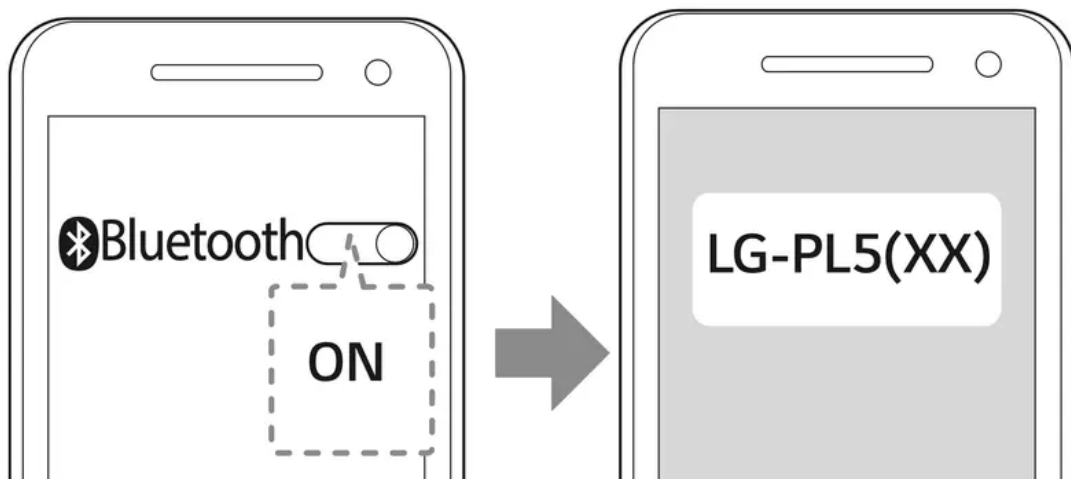

3. Select "LG-PL5 (XX)".

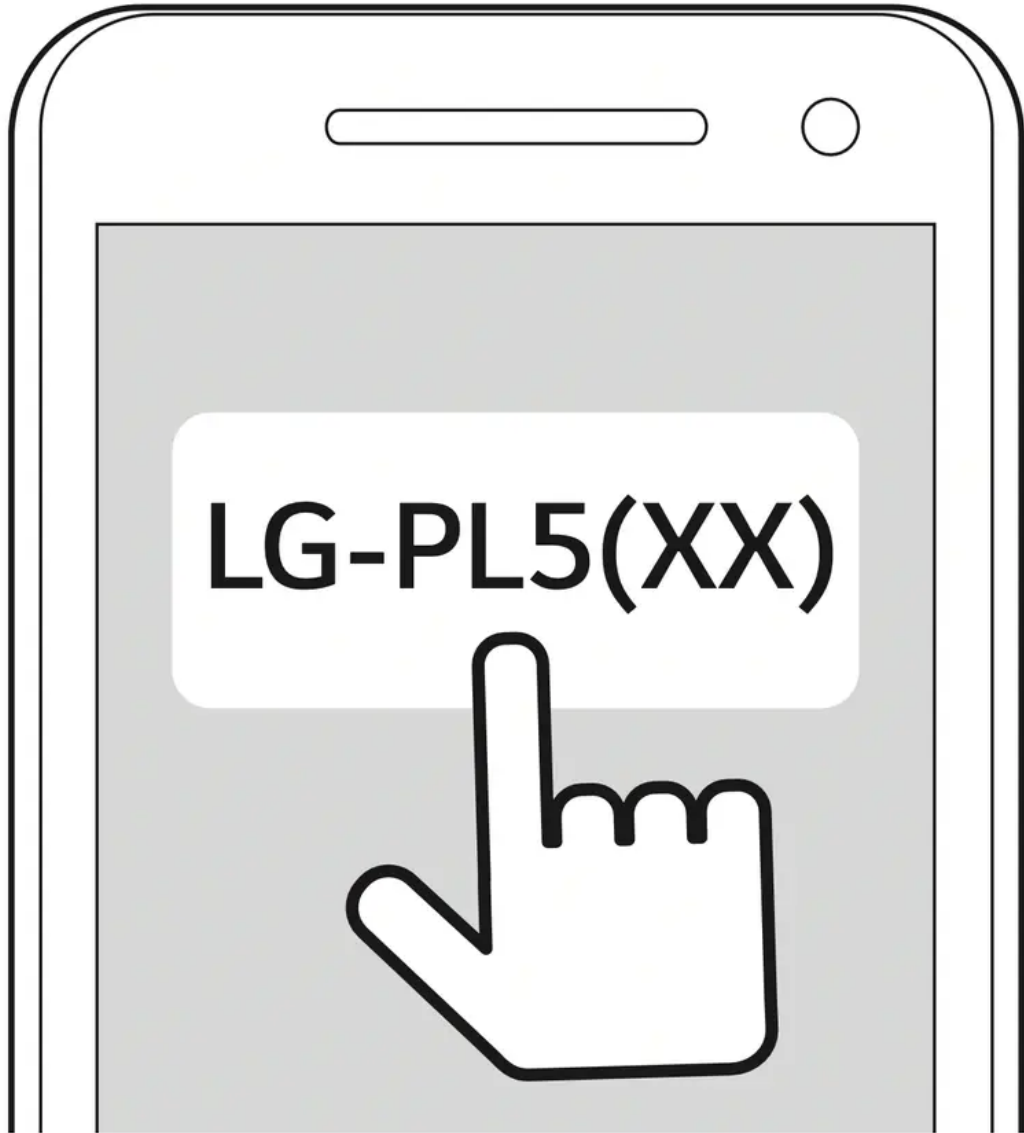

4. When this unit is successfully connected with your Bluetooth device, Bluetooth LED will turn on with the sound.

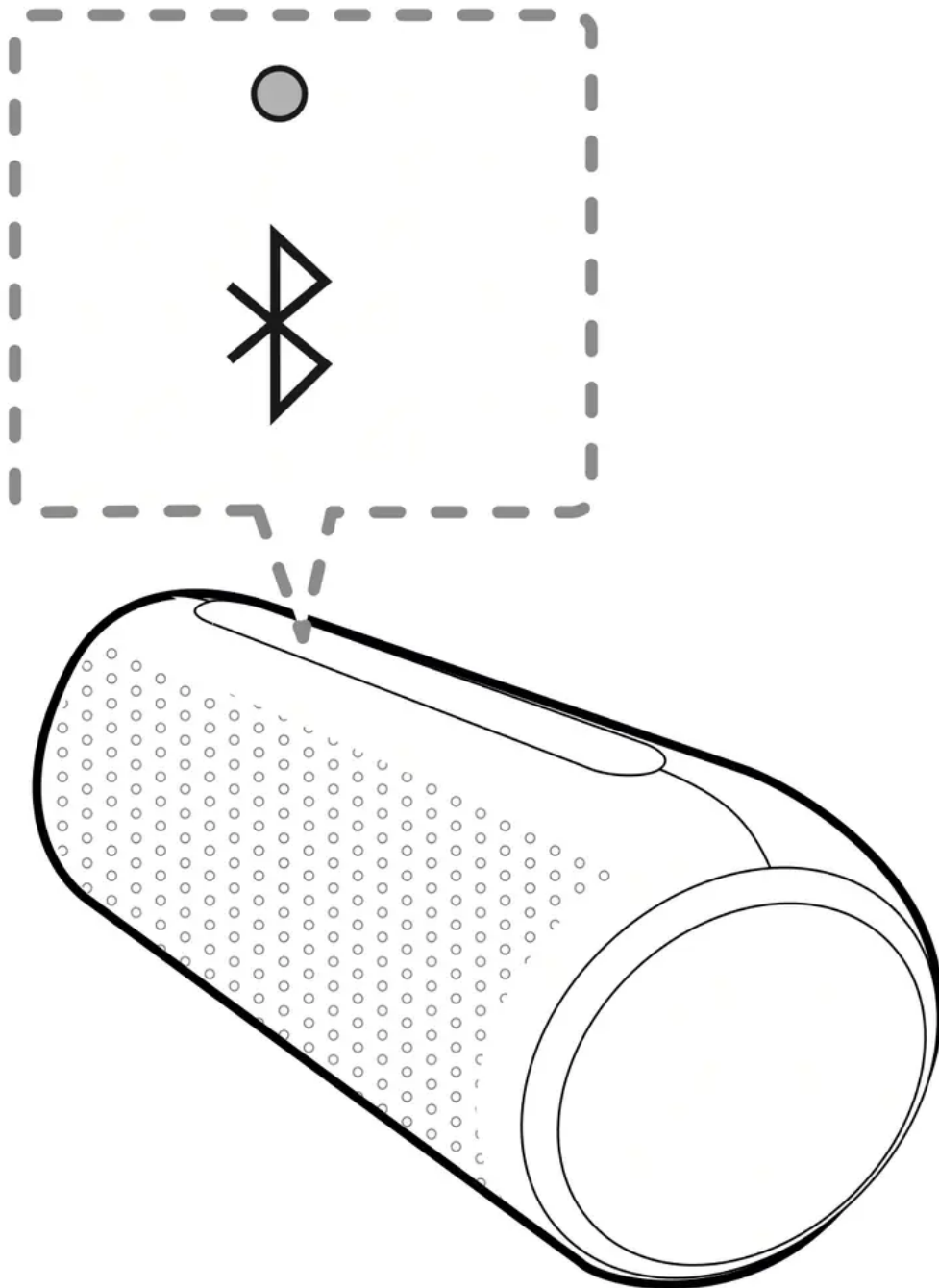

5. Listen to music.

To play a music stored on your Bluetooth device, refer to your Bluetooth device's user guide.

Note

- XX means the last two digits of Bluetooth address. For example, if your unit has a Bluetooth address such as 9C:02:98:4A:F7:08, you will see "LG-PL5 (08)" on your Bluetooth device.

- Depending on the Bluetooth device type, some devices have a different pairing way. For details about Bluetooth pairing, refer to your Bluetooth device manual.

Note

- When using Bluetooth technology, you have to make a connection between the unit and the Bluetooth device as close as possible and keep the distance close.
However you may experience issues in the cases below:
 - There is an obstacle between the unit and the Bluetooth device.
 - There is a device using same frequency with Bluetooth technology such as a medical equipment, a microwave or a wireless LAN device.
- If Bluetooth connection does not work well, go to step 1 of “Pairing your unit and BLUETOOTH device” and try again.
- The sound may be interrupted when the connection interfered by the other electronic wave.
- Depending on the type of the device, you may not be able to use the Bluetooth function.
- You can enjoy Bluetooth function using Smart phone, Notebook, etc..
- The more distance between the unit and the Bluetooth device, the lower the sound quality becomes.
- Bluetooth connection will be disconnected when the unit is turned off or the Bluetooth device gets too far from the unit.
- When Bluetooth connection is disconnected, connect the Bluetooth device to the unit again.
- Bluetooth connection will be maintained even if you change the Bluetooth function to a different function.
- When you connect a Bluetooth device (iOS device etc.) to this unit or operate the device, the volume level will be synchronized between each device.
- When the unit is not connected, Bluetooth LED will blink.
- When you use the Bluetooth function, adjust the volume to a proper level on the Bluetooth device.

Controls connected Bluetooth device

You can control connected Bluetooth device from the unit; play, pause, skip, volume

Note

- Only Android OS and iOS is available to use this function.
- This function may not be supported depending on the Bluetooth device, or operated differently.

Multi phone pairing

The unit can be connected to 2 Bluetooth devices at the same time.

Pairing with Two Devices

1. Connect the unit to a Bluetooth device. (Page 19-21)

2.

When the Bluetooth device and unit are connected, press and hold  button for 2 seconds.

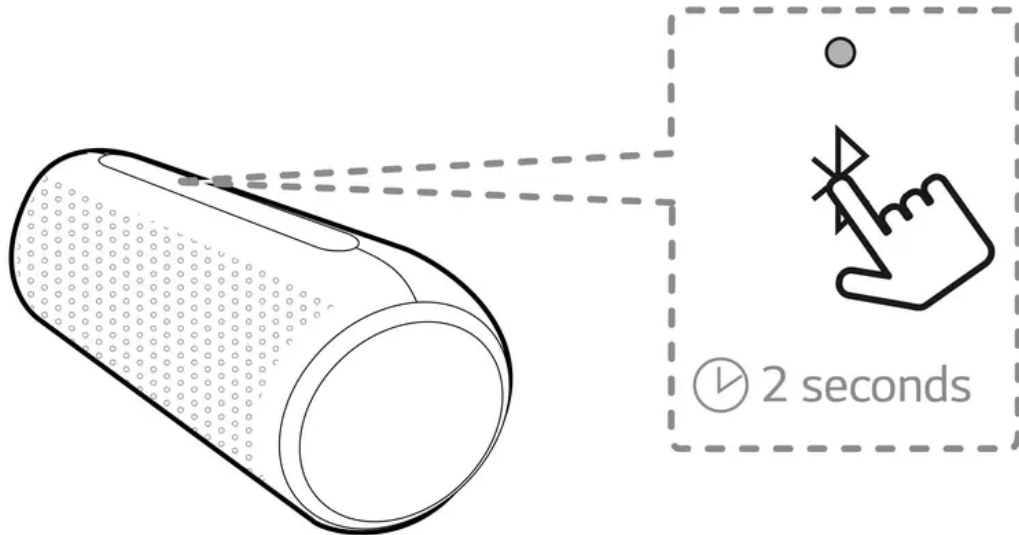

Then Bluetooth LED blinks with the sound. The unit is changed to multi phone pairing mode.

3. Select "LG-PL5 (XX)" from device list on another Bluetooth device.



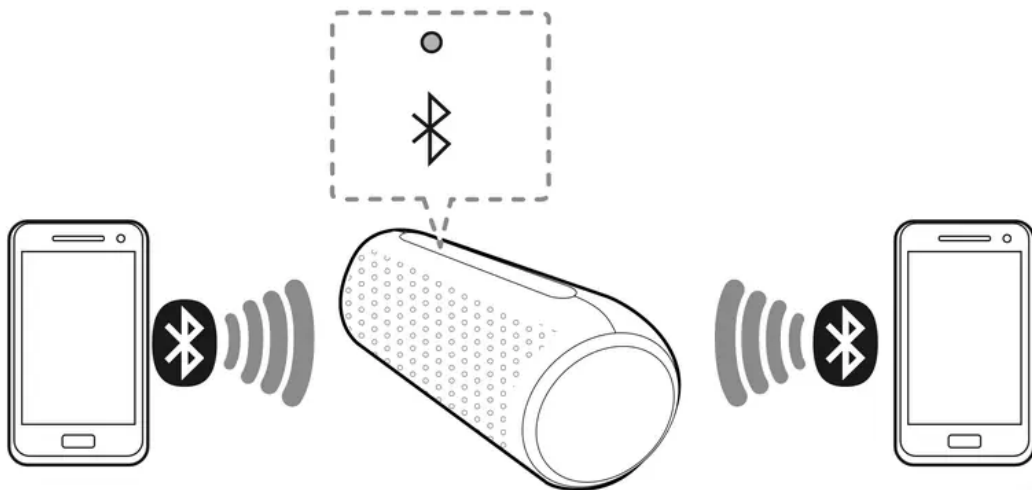

Then the speaker is connection with 2 Bluetooth devices.

4. When connection of 2 Bluetooth devices are successful, Bluetooth LED will turn on.





Note

- When you use Dual Mode, the multi phone pairing connection is not supported. Press  DUAL button to cancel Dual Mode.
- When you use Multi Mode, the multi phone pairing connection is not supported. Press  DUAL button to cancel Multi Mode.
- When you turn off the Main speaker or connect 3.5 mm stereo cable in Multi Mode, it will cancel Multi Mode
- You can connect this unit with up to 2
- Bluetooth devices simultaneously by using the same method as described on the previous page. If you want to connect new Bluetooth device with 2 Bluetooth devices connected, press and hold  button for 2 seconds.
- When the speaker is in the multi phone pairing mode, you will need to connect the other Bluetooth device and speaker within a few minutes (Approx. 1 minute). Otherwise multi phone pairing mode will be canceled.
- Multi phone pairing connection may not be supported depending on the connected device's specifications.
- Removable/detachable Bluetooth device (Ex: Dongle etc..) doesn't support multi phone pairing.
- Even if this speaker is connected with up to 2 Bluetooth devices, you cannot play and control music on both Bluetooth devices at same time. Stop the music if you want to play the other Bluetooth.
- After multi-pairing connection, it takes a little time for the music to be played depending on the Bluetooth devices.
- In case of multi phone pairing, automatic connection of 2 Bluetooth devices is not supported. Only one Bluetooth device will be automatically connected to the speaker. The other device should be connected manually.
- If you get out of Bluetooth's effective distance without disconnecting Bluetooth, it may take a few minutes to connect other Bluetooth devices. But after power off and on, you can connect other Bluetooth devices without waiting.
- If you try to pair a new Bluetooth device when it is already connected to 2 Bluetooth devices, this speaker automatically disconnects one Bluetooth device. (The Bluetooth device in use is excluded from disconnection.)
- In case of multi-pairing, only one Bluetooth device that has control can use voice command.

Dual Mode Connection

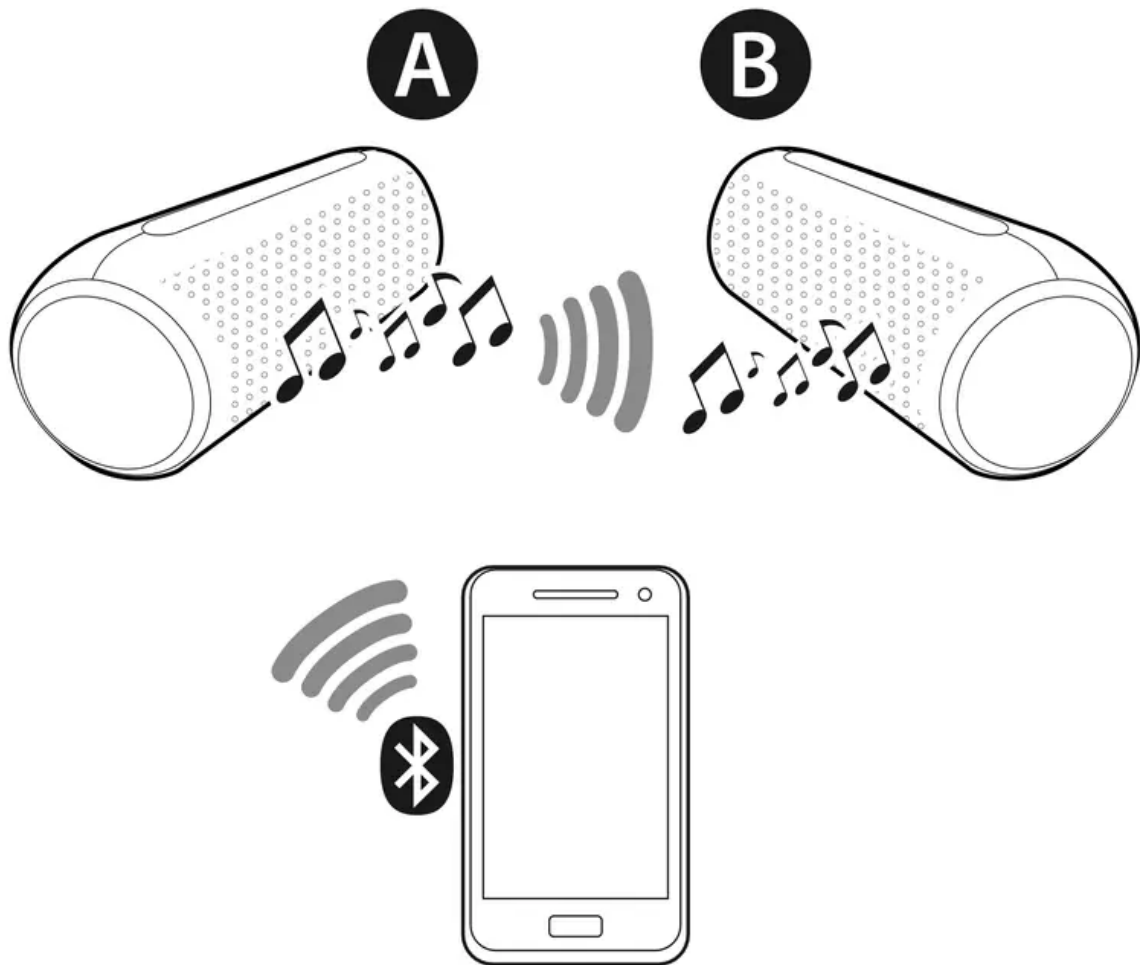
You can enjoy the sound in stereo by using two speakers. For enjoying Dual Mode, you need to purchase another speaker.



1. Press the each speaker's  DUAL button. Then the speakers are ready to Dual Mode.

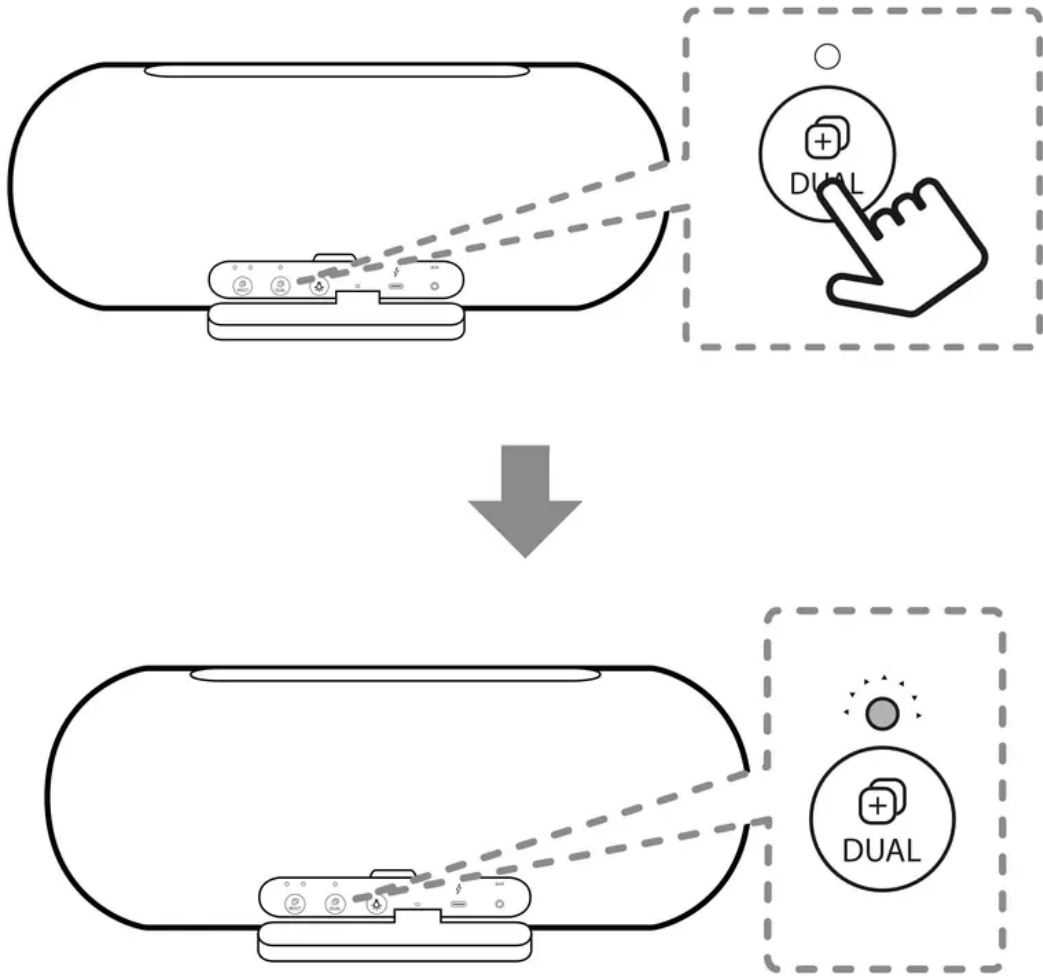

Beep sound is heard and Dual Mode LED will blink white fast.

2. If two speakers are successfully connected, blinking Dual Mode LEDs will stay white. First hear beep sound at main speaker, and then at other speaker.

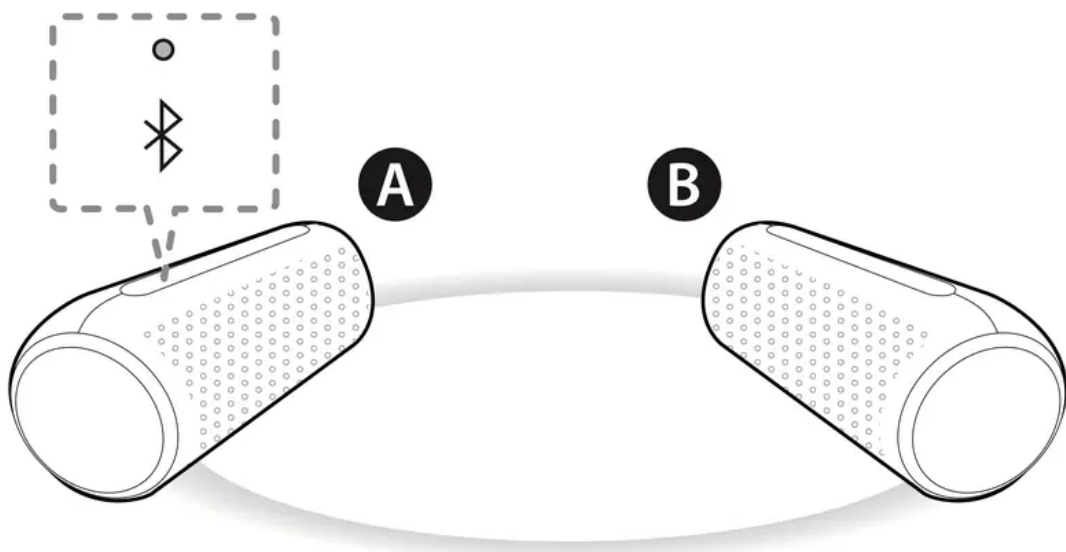

A speaker: Main speaker is to set L (Left) channel and turns on Dual Mode LED and Bluetooth LED.

B speaker: Other speaker is set to R (Right) channel and turns on Dual Mode LED. Bluetooth LED turns off.

Note:



It takes up to 1 minute to connect to Dual Mode.



Using Dual Mode is limited to only PL7 Model and is unavailable on other Portable Bluetooth Speaker.

If you are not connected to Bluetooth device, main speaker's Bluetooth LED blinks. The **A** speaker depends on MAC address of Bluetooth.

3. Play the desired music on the Bluetooth device.

Note

- When you enjoy Dual Mode, Multi phone pairing is not supported.
 - Main speaker (**A**) connects only one Bluetooth device.
- In Dual Mode, you can connect only the main speaker (**A**) with the Bluetooth device.
- If you turn the power off and then on again, two speakers need to be reconnection for using Dual
- If the units fail to connect Dual Mode, go to step 1 and try again.
- When Dual Mode connection is on processing, you cannot search the units on other Bluetooth devices.
- When you disconnect Dual Mode connection, press  DUAL buttons of one of the two speakers again.
- When you enjoy Dual Mode, you can adjust the Volume, Playback, Sound Effect or Mood light of both main (**A**) and other (**B**) speakers at the same time.
- When you connect Dual Mode connection while using AUX mode, this speaker automatically changes to Bluetooth mode.
- In Dual Mode, you can receive a call on only main speaker due to audio howling.
- If you connect 3.5 mm stereo cable in Dual Mode, it will cancel Dual Mode and then change to AUX mode.
- You can connect to Dual Mode connection with "LG XBOOM" app. In this case, the speaker that is connected to "LG XBOOM" app will be the main speaker. You are only able to connect to one speaker when connected to Dual Mode with "LG XBOOM" app.
- To change the Bluetooth device in Dual Mode, press and hold  for 2 seconds to disconnect current Bluetooth device and connect to the desired Bluetooth device.
- When you connect a Bluetooth device (iOS device etc.) to this unit or operate the device, the volume level can be synchronized between each device.

- In Dual Mode, make the distance between the speakers as close as possible each other.
- Depending on network environment, the Dual Mode may not work well.
- In Dual Mode, you can only use voice command on the main speaker.
- Some mobile phones might not play music properly when you try to connect Dual Mode during playback.
- The speaker might not synchronize audio with video (ex. TV etc).
- Press  button,  DUAL button to cancel Dual Mode.
- Press the  MULTI button to disable Dual mode and start Multi mode connection.

Multi Mode Connection

You can enjoy the Multi Mode sound by using multiple speakers. For enjoying Multi Mode, you need to purchase another speaker.

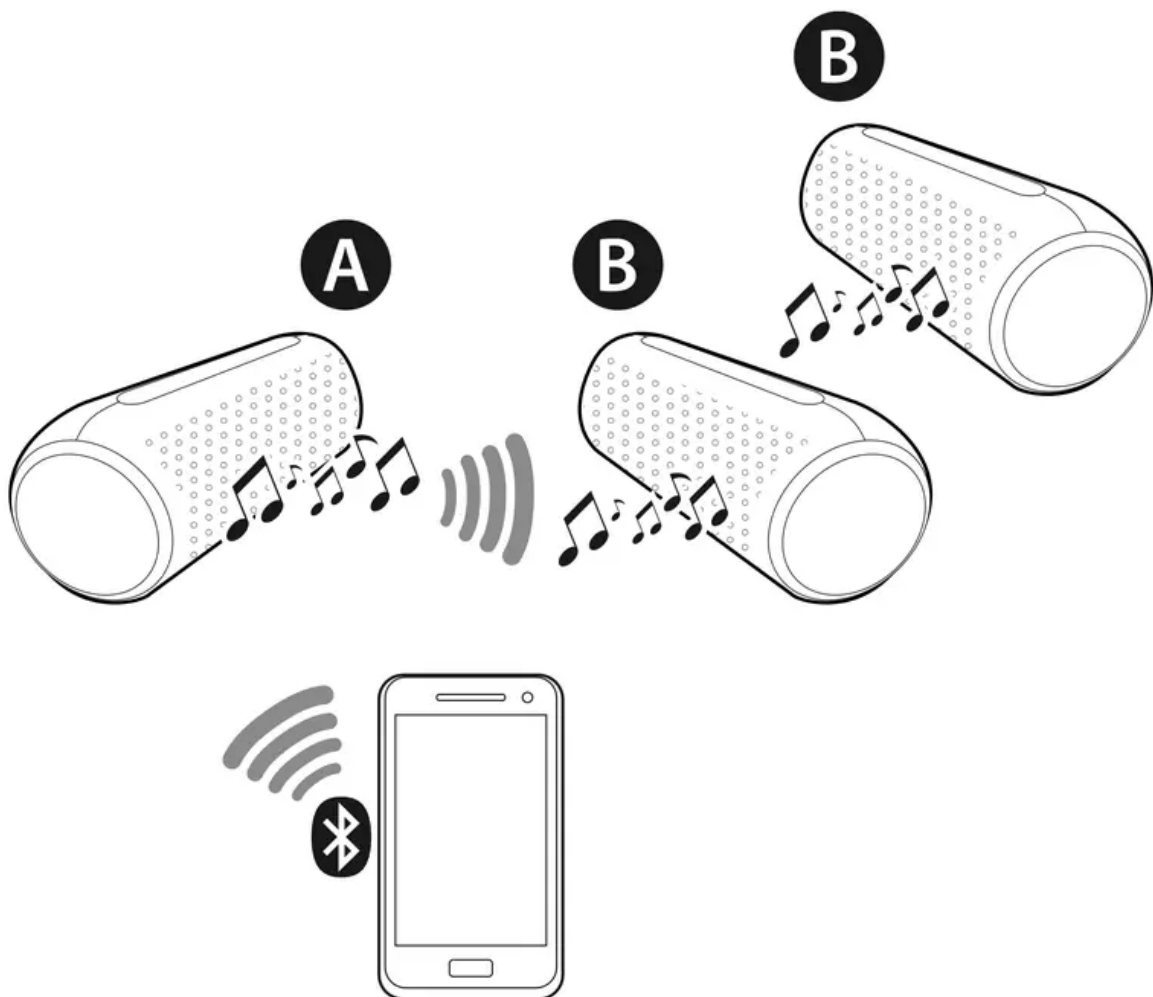

1. Press the each speaker's  MULTI button. Multi Mode LED blinks.

2.  Press **MULTI** repeatedly to select MAIN or OTHER.
A speaker: Selects MAIN.
B speaker: Selects OTHER.

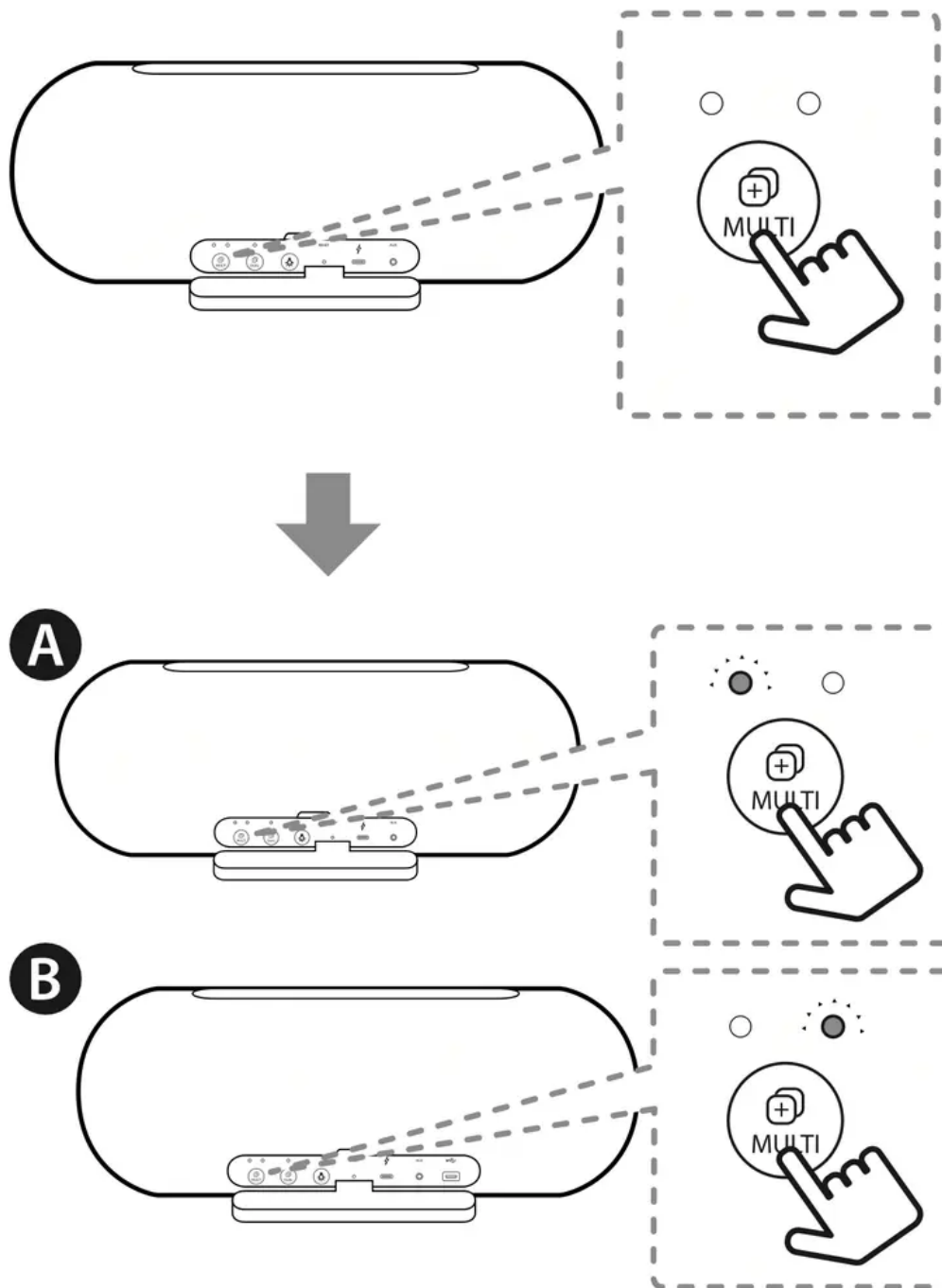

Beep sound is heard and Multi Mode LED will blink white fast.

3. If multiple speakers are connected, blinking Multi Mode LEDs will stay white with beep sound.

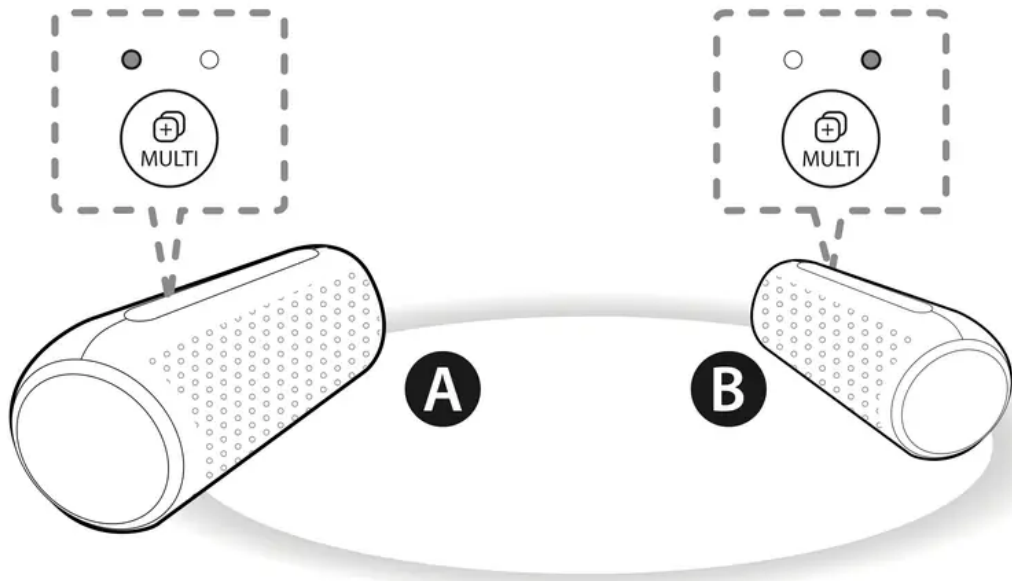

A speaker: Main speaker turns on Multi Mode LED and Bluetooth LED.

B speaker: Other speaker turns on Multi Mode LED. Bluetooth LED turns off.

Note:

It takes up to 1 minute to connect to Multi Mode.

If you want to add Other speakers after 1 minute, you must press the  MULTI button on the Main speaker again and add the Other speaker.

Using Multi Mode is limited to PL5, 7 series model.

If you are not connected to Bluetooth device, main speaker's Bluetooth LED blinks.

4. Play the desired music on the Bluetooth device.

5. Repeat steps 1-2 to add speaker you want.

A speaker: Selects MAIN.



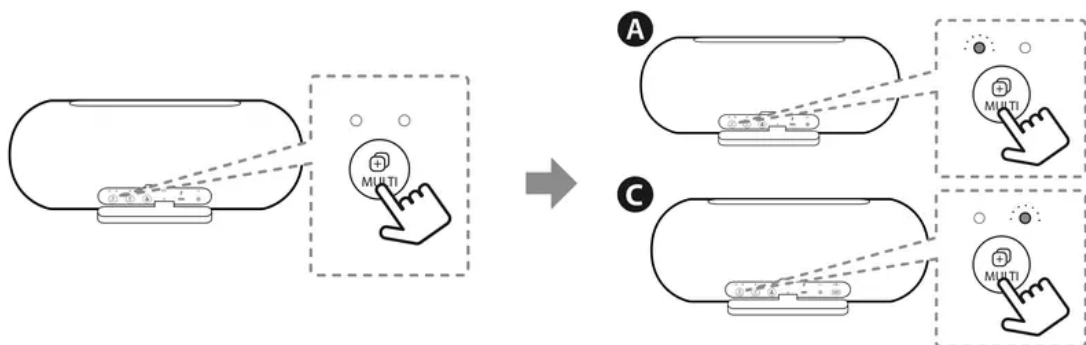

C speaker: Selects OTHER.



Note

- When you enjoy Multi Mode, Multi phone pairing is not supported.
 - Main speaker (**A**) connects only one Bluetooth device.
- In Multi Mode, you can connect only the main speaker (**A**) with the Bluetooth device.



- If you turn the power off and then on again, each speakers need to be reconnection for using Multi Mode.
- If the units fail to connect Multi Mode, go to step 1 and try again.
- When you enjoy Multi Mode, the Playback or Mood light on the Main speaker (**A**) are interlocked with the Other speaker.
- When you enjoy Multi Mode, the all buttons on the Other speaker are not interlocked with the Main (**A**) speaker.
- When you connect Multi Mode connection while using AUX mode, this speaker automatically changes to Bluetooth mode.
- In Multi Mode, you can receive a call on only main speaker due to audio howling.
- If you connect 3.5 mm stereo cable in Multi Mode, it will cancel Multi Mode and then change to AUX mode.
- You can connect to Multi Mode connection with "LG XBOOM" app. In this case, the speaker that is connected to "LG XBOOM" app will be the main speaker. You can connect multiple other speakers using the "LG XBOOM" app.
- To change the Bluetooth device in Multi Mode, press and hold  for 2 seconds to disconnect current Bluetooth device and connect to the desired Bluetooth device.
- When you connect a Bluetooth device (iOS device etc.) to this unit or operate the device, the volume level can be synchronized between each device.
- In Multi Mode, make the distance between the speakers as close as possible each other.
- Depending on network environment, the Multi Mode may not work well.
- Some mobile phones might not play music properly when you try to connect Multi Mode during playback.
- The speaker might not synchronize audio with video (ex. TV etc).
- Press  DUAL button to cancel Multi Mode.
- When you search for speakers with the "LG XBOOM" App, you may not be able to find all the speakers due to the surrounding environment. In this case please search again and connect.
- If you connect a large number of products at the same time, there is a possibility that the search will fail or the connection will fail. If it fails, please search again and connect.
- When you press  MULTI button on the speaker to select OTHER and then press  MULTI button again after beep sound, Multi Mode connection is released.

Other Operation

Resetting

If have a malfunction with the speaker, press the RESET button using an object like a thin pin.

Then speaker turns off. Press  button to try turning on speaker again.

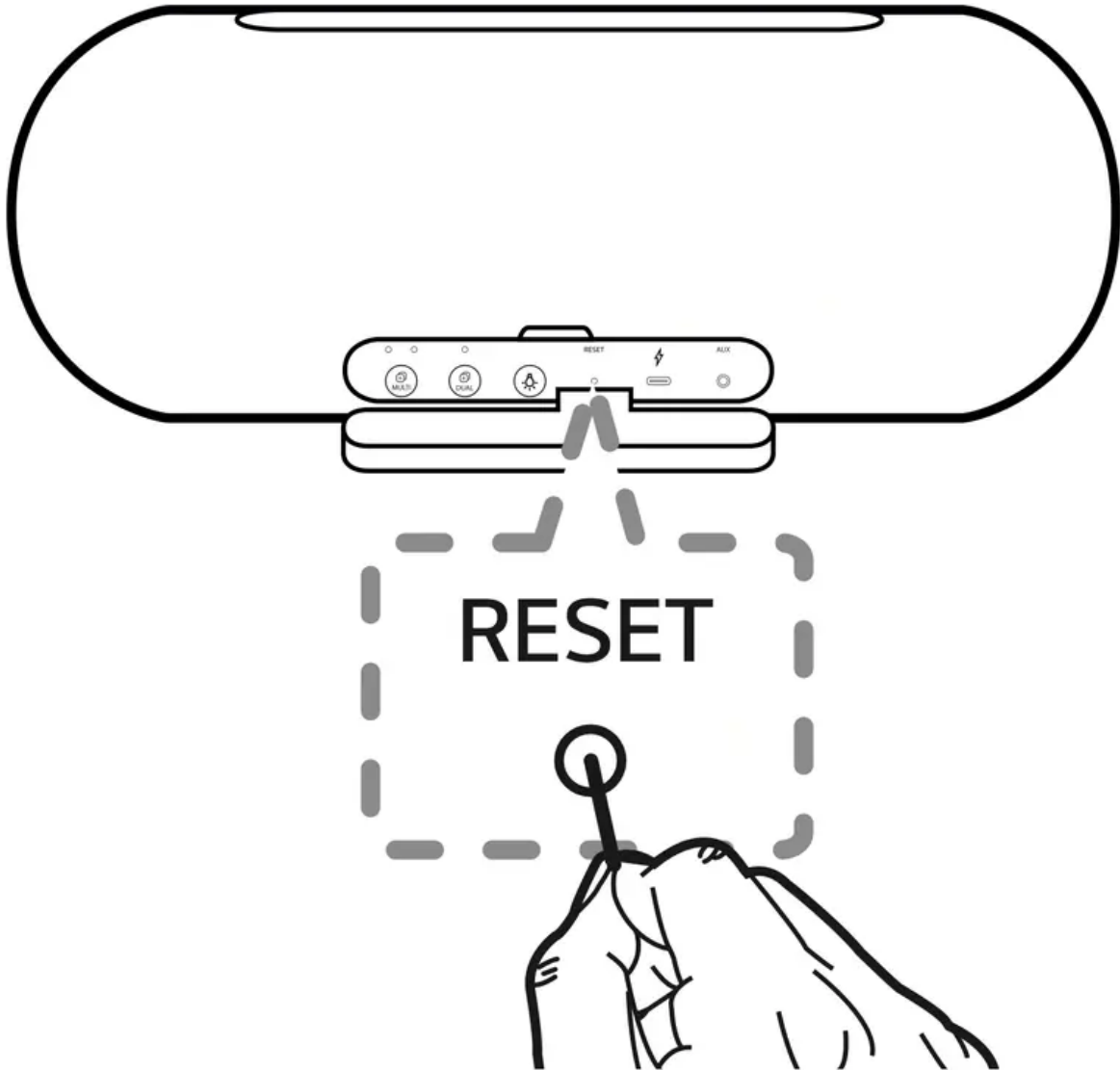

Turn on/off the beep sound





Set up the beep sound through "LG XBOOM" app: "LG XBOOM" menu --> [Setting] --> [Beep Sound]

Notice for Auto Power Off

When the unit is in Bluetooth mode without music playback for 6 hours or in AUX mode without button operation for 6 hours, this unit is turned off automatically.

The function can be turned on or off.

When setting is changed in the order as below, Power LED blinks 5 times with beep sound.

Function	How to
ON	Press and hold  ,  for 2 seconds simultaneously.
OFF	Press and hold  ,  for 2 seconds simultaneously.

Note

- You can toggle this function on and off through “LG XBOOM” app.
- If the function was off, speaker will be off in this way that press the  button or battery is completely discharged



Troubleshooting

Problem	Cause & Correction
No Power.	<ul style="list-style-type: none"> • The battery is discharged. Recharge the battery. • Connect the unit to the power supply with the AC adapter.
No sound or sound distortion.	<ul style="list-style-type: none"> • The unit or your smart device's volume is set to minimum. Check and adjust the volume of the unit or Bluetooth device's volume. • When you use an external device at high volume, the sound quality may be deteriorated. Lower the volume of the devices. • If you use the unit for purposes other than listening to music, the sound quality may be lowered or the unit may not work properly.
Bluetooth pairing does not work well.	<ul style="list-style-type: none"> • Switch Bluetooth off and on again on your Bluetooth device, then try pairing again. • Be sure your Bluetooth device is on. • Remove the obstacle in the path of the Bluetooth device and the unit. • Depending on the type of the Bluetooth device or surrounding environment, your device may not be paired with the unit.
The unit does not operate normally.	<ul style="list-style-type: none"> • If the battery was fully discharged, the stored Bluetooth information can be deleted. Previous setting may not be saved when the unit's power is shut off. • In case of malfunction, please use the unit in proper place where the temperature or humidity is not so high or low. • In case of overload, power and Bluetooth LEDs blink white. Please turn the power off and then on again.
Above solutions do not work.	<ul style="list-style-type: none"> • Press the RESET button on speaker using an object like a thin pin. (Page 30)

Warning



This content is compiled from multiple sources and is provided for reference purposes only. It may not be complete or fully applicable to all situations. If you are unable to resolve your issue, please contact the product manufacturer or an authorized service provider for official support.

Document generated by [ManualsFile](#)

