

Preparing

- When the TV is turned on for the first time after being shipped from the factory, initialization of the TV may take approximately one minute.
 - Image shown may differ from yours.
 - Your TV's OSD (On Screen Display) may differ slightly from that shown in this manual.
 - The available menus and options may differ from the input source or product model that you reusing.
 - New features may be added to this TV in the future.
 - The device must be easily accessed to a location outlet near the access. Some devices are not made by turning on /off button, turning off the device and unplugging the power cord.
 - The items supplied with your product may vary depending upon the model.
 - Product specifications or contents of this manual may be changed without prior notice due to up grade of product functions.
 - For an optimal connection, HDMI cables and USB devices should have bezels less than 10 mm (0.39 inches) thick and 18 mm (0.7 inches) width.
 - Use an extension cable that supports USB 2.0 if the USB cable or USB flash drive does not fit into your TV's USB port.
 - Use a certified cable with the HDMI logo attached. If you do not use certified HDMI cable, the screen may not display or a connection error may occur.
 - Recommended HDMI cable types (3 m (9.84feet)or less)
- High-Speed HDMI®/™ cable
 - High-Speed HDMI®/™ cable with Ethernet

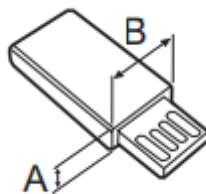
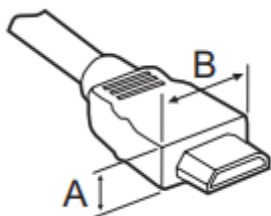

*A ≤ 10 mm (0.39 inches)

*B ≤ 18 mm (0.7 inches)

How to use the ferrite core, (Depending upon model)

- Use the ferrite core to reduce the electromagnetic interference in the power cord. Wind the power cord on the ferrite core once.

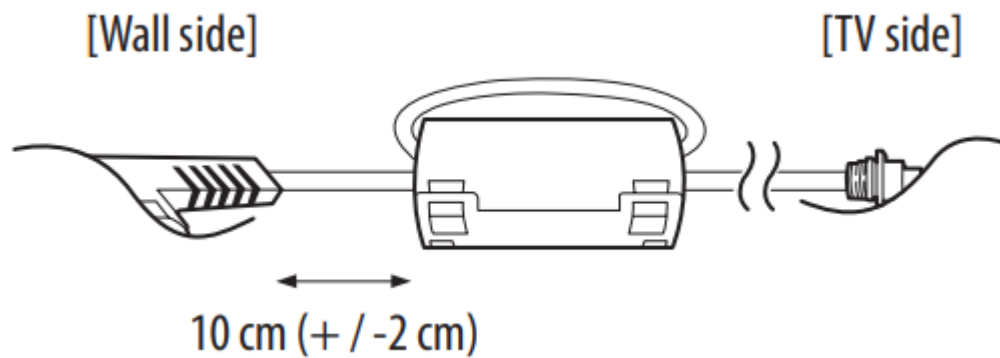

Optional Extras

Optional extras can be changed or modified for quality improvement without any notification. Contact your dealer for buying these items. These devices work only with certain models.

The model name or design may be changed due to the manufacturer's circumstances or policies.

Magic Remote Control

(Depending upon model)

AN-MR18BA

Check whether your TV model supports Bluetooth in the Wireless Module Specification to verify whether it can be used with the Magic Remote.

Wall Mounting Bracket

(Depending upon model)

Make sure to use screws and wall mount bracket that meet the VESA standard. Standard dimensions for the wall mount kits are described in the following table.

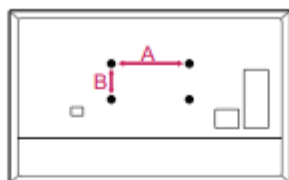

Model	49SK80* 49UK77* 49UK75* 43/50UK65* 43/50UK63* 43UK62* 32LK61* 43LK57* 43/50UK60*	55SK80* 55UK77* 55UK75* 55UK65* 49/55UK63* 49/55UK62* 49LK57* 49/55UK60*
VESA (A x B) (mm)	200 x 200	300 x 300
Standard screw	M6	M6
Number of screws	4	4
Wall mount bracket (optional)	LSW240B MSW240	OLW480B MSW240

Model	55/65SK95* 55/65SK90* 55/65SK85* 65SK80* 65UK77* 65UK75* 65UK65* 65UK63* 60/65UK62* 60/65UK60*	75SK80* 70/75/86UK65* 75UK62* 70/75UK61* 86UK75*
VESA (A x B) (mm)	300 x 300	600 x 400
Standard screw	M6	M8
Number of screws	4	4
Wall mount bracket (optional)	OLW480B	LSW640B

Lifting and moving the TV

When moving or lifting the TV, read the following to prevent the TV from being scratched or damaged and for safe transportation regardless of its type and size.

- It is recommended to move the TV in the box or packing material that the TV originally came in.
- Before moving or lifting the tv, disconnect the power cord and all cables.

- When holding the TV, the screen should face away from you to avoid damage.



- Hold the top and bottom of the TV frame firmly. Make sure not to hold the transparent part, speaker, or speaker grill area.

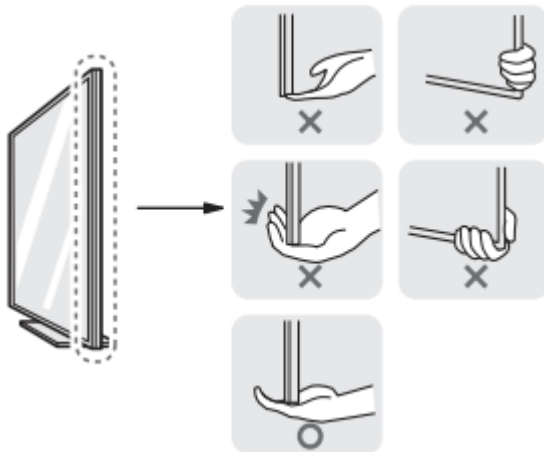

- Use at least two people to move a large TV.
- When transporting the TV by hand, hold the TV as shown in the following illustration.

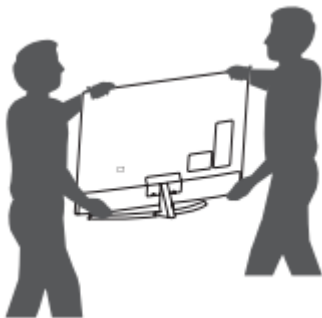

- When transporting the TV, do not expose the TV to jolts or excessive vibration.
- When transporting the TV, keep the TV upright; never turn the TV on its side or tilt towards the left or right.
- When handling the TV, be careful not to damage the protruding buttons.



- Avoid touching the screen at all times, as this may result in damage to the screen.

- Do not place the product on the floor with its front facing down without padding. Failure to do so may result in damage to the screen.
- Do not move the TV by holding the cable holders, as the cable holders may break, and injuries and damage to the TV may occur, (Depending upon model).
- When attaching the stand to the TV set, place the screen facing down on a cushioned table or flat surface to protect the screen from scratches.

Mounting on the Table

1. Lift and tilt the TV into its upright position on a table.

- Leave a minimum of 10 cm (4 inches) space from the wall for proper ventilation.

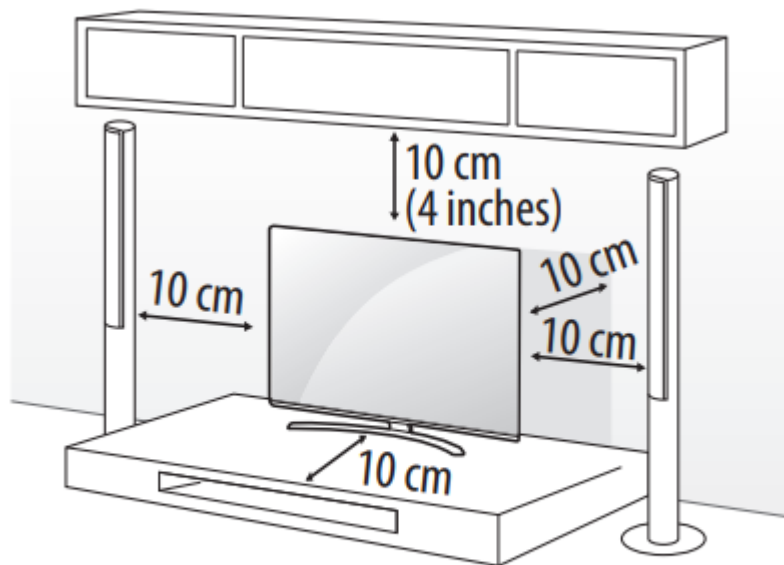

(Depending upon model)

2. Connect the power cord to a wall outlet.



- Do not apply foreign substances (oils, lubricants, etc.) to the screw parts when assembling the product. (Doing so may damage the product.)
- If you install the TV on a stand, you need to take actions to prevent the product from overturning. Otherwise, the product may fall over, which may cause injury.
- Do not use any unapproved items to ensure the safety and product life span.
- Any damage or injuries caused by using unapproved items are not covered by the warranty.

- Make sure that the screws are fastened tightly. (If they are not fastened securely enough, the TV may tilt forward after being installed.)
- Do not fasten the screws with excessive force otherwise, they may strip and become loose.

Securing TV to the Wall

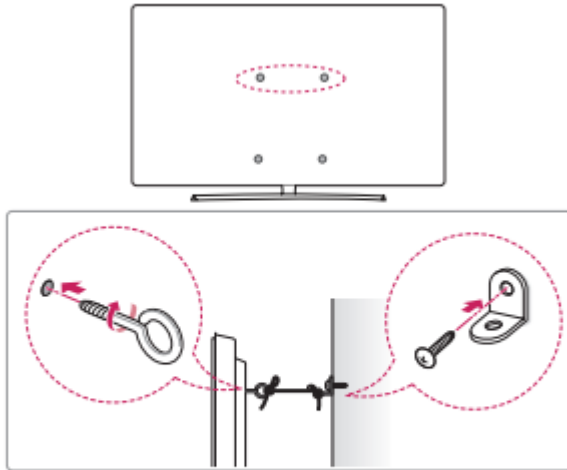

(Depending upon model)

1. Insert and tighten the eye-bolts, or brackets and bolts on the back of the TV.

- If there are bolts inserted at the eye-bolts position, remove the bolts first.

2. Mount the wall brackets with the bolts to the wall.

Match the location of the wall bracket and the eye-bolts on the rear of the TV.

3. Connect the eye-bolts and wall brackets tightly with a sturdy rope. Make sure to keep the rope horizontal with the flat surface.

- Use a platform or cabinet that is strong and large enough to support the TV securely.
- Brackets, bolts, and ropes are not provided. You can obtain additional accessories from your local dealer.

Mounting to the Wall

An optional wall mount can be used with your LG Television. Consult with your local dealer for a wall mount that supports the VESA standard used by your TV model. Carefully attach the wall mount bracket at the rear of the TV. Install the wall mount bracket on a solid wall perpendicular to the floor. If you are attaching the TV to other building materials, please contact qualified personnel to install the wall mount. Detailed instructions will be included with the wall mount.

We recommend that you use an LG brand wall mount. The LG wall mount is easy to adjust to connect the cables. When you do not use LG's wall mount bracket, use a wall mount bracket

where the device is adequately secured to the wall with enough space to allow connectivity to external devices. If you are using a non-adjustable mount, attach the mount to the wall. Attach the cables to the TV first, then attach the TV to the mount.

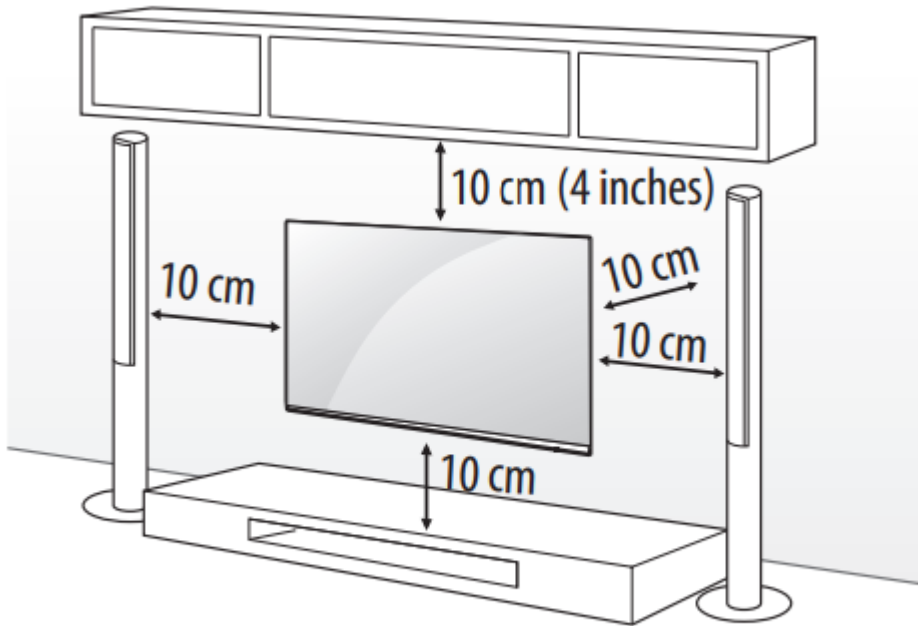

(Depending upon model)



- Remove the stand before installing the TV on a wall mount by performing the stand attachment in reverse.
- For more information of screws and wall mount bracket, refer to the Separate purchase.
- If you intend to mount the product to a wall, attach VESA standard mounting interface (optional parts) to the back of the product. When you install the set to use the wall mounting bracket (optional parts), fix it carefully so as not to drop.
- When mounting a TV on the wall, make sure not to install the TV by hanging the power and signal cables on the back of the TV.
- Do not install this product on a wall if it could be exposed to oil or oil mist. This may damage the product and cause it to fall.

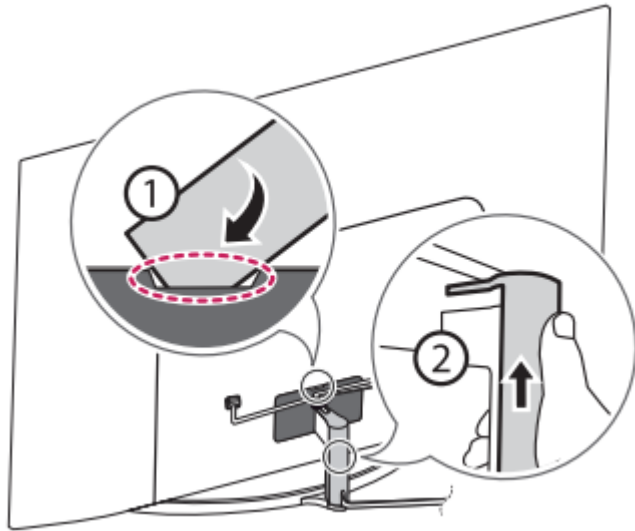

- Do not use a sharp object when you detached the cable cover. This could damage the cable or the cabinet. It may also cause personal harm, (Depending upon model).
- When installing the wall mounting bracket, it is recommended to cover the stand hole using tape, in order to prevent the influx of dust and insects, (Depending upon model).

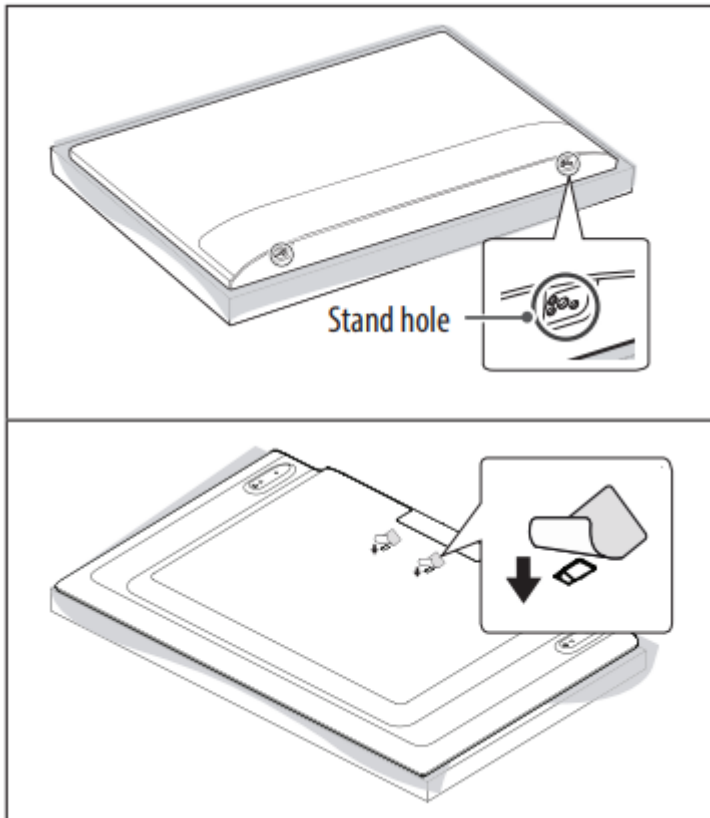

Connections

You can connect various external devices to the TV. For more information on external device's connection refer to the manual provided with each device.

Antenna/Cable

Connect an antenna, cable, or cable box to watch TV while referring to the following. The illustrations may differ from the actual items and an RF cable is optional.

- Make sure not to bend the copper wire of the RF cable.

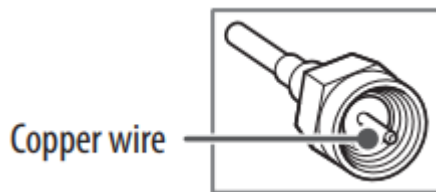





- Complete all connections between devices, and then connect the power cord to the power outlet to prevent damage to your TV.
- Use a signal splitter to use 2 TVs or more.
- DIV Audio Supported Codec: MPEG, Dolby Digital
- This TV cannot receive ULTRA HD (3840 x 2160 pixels) broadcasts, directly because the related standards have not been confirmed, (Depending upon model).

Other connections

HDMI

- HDMI AudioSupportedFormat: (Depending upon model) DTS(44.1kHz /48kHz /88.2kHz / 96kHz), DTS HD (44.1kHz /48kHz /88.2kHz /96kHz /176.4kHz /192 kHz), True HD (48kHz), Dolby Digital / Dolby DigitalPlus (32kHz /44.1kHz /48kHz), PCM (32kHz /44.1kHz /48kHz / 96kHz /192kHz)

(Only UHD models)

-  →  →  () → Picture → Additional Settings → HDMI ULTRA HD Deep Color

- On :Support4K @ 60 Hz (4:4:4,4:2:2,4:2:0)

- Off :Support4K @ 60 Hz8bit (4:2:0)

If the device connected to Input Portal so supports ULTRA HD Deep Color, your picture may be clearer. However, if the device doesn't support it, it may not work properly. In that case, change the TV's HDMI ULTRA HD Deep Color setting to off.

- This feature is available only on certain models which support HDMI ULTRA HD DeepColor.

External Devices

Supported external devices are Blu-ray player, HD receivers, DVD players, VCRs, audio systems, USB storage devices, PC, gaming devices, and other external devices. For more information on external device's connection, refer to the manual provided with each device.

- If you record a TV program on a Blu-ray/DVD recorder or VCR, make sure to connect the TV signal input cable to the TV through a DVD recorder or VCR. For more information about recording, refer to the manual provided with the connected device.
- The external device connections shown may differ slightly from illustrations in a manual.
- Connect external devices to the TV regardless about the order of the TV port.
- If you connect a gaming device to the TV, use the cable supplied with the gaming device.
- Refer to the external equipment's manual for operating instructions.
- In PC mode, there may be noise associated with the resolution, vertical pattern, contrast or brightness. If noise is present, change the PC output to another resolution, change the refresh rate to another rate or adjust the brightness and contrast on the [Picture] menu until the pictures is clear. Depending upon the graphics card, some resolution settings may not allow the image to be positioned on the screen properly.
- Some USB Hubs may not work. If a USB device connected through a USB Hub is not detected, connect directly to the USB port on the TV.
- When connecting via a wired LAN, it is recommended to use a CAT 7 cable.
- The TV may be capable of operating without a set-top-box from a multichannel video programming distributor (MVPD).
- For LK series, HDR (High Dynamic Range) pictures can be viewed over the Internet or via USB and HDMI 1.4 compatible devices.

Remote RS-232C setup

To obtain the RS-232C external control setup information, please visit website. Download and read the manual, (Depending upon model).



- Do not drop the product or let it fall over when connecting external devices. Otherwise, this may result in injury or damage to the product.
- When connecting external devices such as video game consoles, make sure the connecting cables are long enough. Otherwise, the product may fall over, which may cause injury or damage the product.

Using Button

You can simply operate the TV functions, using the button.







Basic functions

	<p>Power On (Press) Power Off ¹ (Press and Hold) Menu Control (Press ²) Menu Selection (Press and Hold ³)</p>
---	--

1. All running apps will close.
2. You can access and adjust the menu by pressing the button when TV is on.
3. You can use the function when you access menu control.

Adjusting the menu

When the TV is turned on, press the  button one time. You can adjust the Menu items using the button.

	Turns the power off.
	Changes the input source.
	Scrolls through the saved channels.
	Adjusts the volume level.

Using Remote Control

(Depending upon model)

The descriptions in this manual are based on the buttons on there mote control. Please read this manual carefully and use the TV correctly.

















To install batteries, open the battery cover, replace batteries (1.5 V AAA) matching the \oplus and \ominus ends to the label inside the compartment, and close the battery cover. To remove the batteries, perform the installation actions in reverse. This remote uses infrared light. When in use, it should be pointed in the direction of the TV's remote sensor.

Make sure to point the remote control toward the remote control sensor on theTV.



(Some buttons and services may not be provided depending upon models or regions.)

* To use the button, press and hold for more than 3 seconds.



 **(POWER)** Turns the TV on or off.
TV Returns to the last TV channel.
CC/SUB Activates or deactivates the subtitles.
 **(Q. Settings)** Accesses the Quick Settings.
 **(Search)** Shows the search mode.
 **(Input)** Changes the input source.
Number button Enters numbers.
 **(Dash)** Inserts a dash between numbers such as 2-1 and 2-2.
LIST Accesses the saved channel list.
Q.VIEW Alternates between the two last channels selected (pressing repeatedly).
QUICK ACCESS* You can access the application or Live TV channel by using the number buttons as registered.
+ VOL - Adjusts the volume level.
FAV Accesses your favorite channel list.
 **INFO** Shows information on the current program.
 **(MUTE)** Mutes all sounds.
 *** (MUTE)** Accesses the **Accessibility** menu.
 **CH** Scrolls through the saved channels.
 **PAGE** Moves to the previous or next screen.
 **Streaming Service buttons** Connects to the Video Streaming Service.
 **(Home)** Accesses the Home menu.
 *** (Home)** Shows the previous history.
GUIDE Displays the program event according to time scheduler.
 **LIVE ZOOM** By zooming in on the selected area, you can view it in full screen.
Navigation button (up / down / left / right) Scrolls through menus or options.
 Selects menus or options and confirms your input.
BACK Returns to the previous screen.
EXIT Clears all on-screen displays and returns to TV viewing.
SAP/* Enables SAP (Secondary Audio Program) Feature, (Depending upon model).
REC/* Starts to record. (Only Time Machine^{Ready} supported model) (Depending upon model)
 Control buttons for media contents
 These access special functions in some menus.

Registering Magic Remote Control

(Depending upon model)

The descriptions in this manual are based on the buttons on the remote control. Please read this manual carefully and use the TV correctly.

When the message “Magic remote battery is low. Please change the battery.” is displayed, replace the batteries.

To install batteries, open the battery cover, replace batteries (1.5 V AAA) matching the  and  ends to the label inside the compartment, and close the battery cover. Be sure to point the magic remote toward the remote control sensor on the TV. To remove the batteries, perform the installation actions in reverse. This remote uses infrared light. When in use, it should be pointed in the direction of the TV’s remote sensor.



(Some buttons and services may not be provided depending upon models or regions.)

* To use the button, press and hold for more than 3 seconds.

(POWER) Turns the TV on or off.

STB PWR You can turn your set-top box on or off by adding the set-top box to the universal remote control for your TV.

Number buttons Enters numbers.

- **(Dash)** Inserts a dash between numbers such as 2-1 and 2-2.

LIST Accesses the saved channel list.

(Screen Remote) Displays the Screen Remote.

- Accesses the Universal Control Menu in some regions.

*** (Screen Remote) SAP** (Secondary Audio Program) Feature can be enabled by pressing the key.

QUICK ACCESS* You can access the application or Live TV channel by using the number buttons as registered.

VOL Adjusts the volume level.

(MUTE) Mutes all sounds.

*** (MUTE)** Accesses the **Accessibility** menu.

CH Scrolls through the saved channels.

*** (Voice recognition)**

Network connection is required to use the voice recognition function.

Once the voice display bar is activated on the TV screen, press and hold the button and speak your command out loud.

(HOME) Accesses the Home menu.

*** (HOME)** Shows the previous history.

Wheel (OK) Press the center of the Wheel button to select a menu. You can change channels by using the Wheel button.

(up/down/left/right) Press the up, down, left or right button to scroll the menu. If you press buttons while the pointer is in use, the pointer will disappear from the screen and Magic Remote will operate like a general remote control. To display the pointer on the screen again, shake Magic Remote to the left and right.

BACK Returns to the previous level.

BACK* Clears on-screen displays and returns to last input viewing.

GUIDE Displays the program event according to time scheduler.

Streaming Service buttons Connects to the Video Streaming Service.

(INPUT) Changes the input source.

*** (INPUT)** Displays all the lists of external inputs.

(Q, Settings) Accesses the Quick Settings.

*** (Q, Settings)** Displays the **All Settings** menu.

These access special functions in some menus.

II Control buttons for media contents

LIVE ZOOM By zooming in on the selected area, you can view it in full screen.

FOCUS* You can zoom in on the area where the remote control is pointed.

Registering Magic Remote Control

How to register the Magic Remote Control

To use the Magic Remote, first pair it with your TV.

1. Put batteries into the Magic Remote and turn the TV on.
2. Point the Magic Remote at your TV and press the **Wheel (OK)** on the remote control.

*If the TV fails to register the Magic Remote. try again after turning the TV off and back on.

How to deregister the Magic Remote Control

Press the **BACK** and **(HOME)** buttons the same time, for five seconds, to unpair the Magic Remote with your TV.

Press and hold the **GUIDE** button for more than 5 seconds to disconnect and re-register the Magic Remote at the same time.



- Do not mix new batteries with old batteries. This may cause the batteries to overheat and leak.
- Failure to match the correct polarities of the battery may cause the battery to burst or leak, resulting in fire, personal injury, or ambient pollution.
- This apparatus uses batteries. In your community, there might be regulations that require you to dispose of these batteries properly due to environmental considerations. Please contact your local authorities for disposal or recycling information.
- Batteries inside or outside the product shall not be exposed to excessive heat such as sunshine, fire or the like.

Troubleshooting

Cannot control the TV with the remote control.

- Check if anything such as tape has been placed over the receiver.
- Check if there is any obstacle between the product and the remote control.
- Replace the batteries with new fresh ones.

No image display and no sound is produced.

- Check if the product is turned on.
- Check if the power cord is connected to a wall outlet.
- Check if there is a problem in the wall outlet by connecting other products.

The TV turns off suddenly.

- Check the power control settings. The power supply may be interrupted.
- Check if the auto-off function is activated in the settings menu.
- If there is no signal while the TV is on, the TV will turn off automatically after 15 minutes of inactivity.

Abnormal Display

- If the TV feels cold to the touch, there may be a small flicker when it is turned on. This is normal; there's nothing wrong with TV. Some minute dot defects may be visible on the screen, appearing as tiny red, green, or blue spots. However, they have no adverse effect on the TV's performance. Avoid touching the LCD screen or holding your finger(s) against it for long period of time. Doing so may produce some temporary distortion effects on the screen.

- This panel is an advanced product that contains millions of pixels. In a very few cases, you could see fine dots on the screen while you're viewing the TV. Those dots are deactivated pixels and do not affect the performance and reliability of the TV.
- Displaying a still image for a prolonged period of time may cause an image sticking. Avoid displaying a fixed image on the TV screen for an extended length of time.

Generated Sound

- Cracking noise A cracking noise that occurs when watching or turning off the TV is generated by plastic thermal contraction due to temperature and humidity. This noise is common for products where thermal deformation is required.
- Electrical circuit humming/panel buzzing A low level noise is generated from a high-speed switching circuit, which supplies a large amount of current to operate a product. It varies depending upon the product. This generated sound does not affect the performance and reliability of the product.



- When cleaning the product, be careful not to allow any liquid or foreign objects to enter the gap between the upper, left or right side of the panel and the guide panel, (Depending upon model).

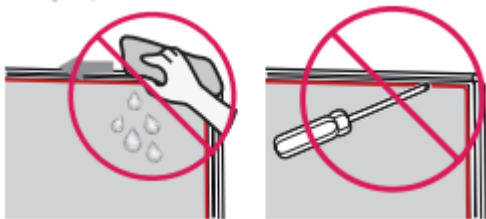

- Make sure to wring any excess water or cleaner from the cloth.
- Do not spray water or cleaner directly onto the TV screen.
- Make sure to spray just enough of water or cleaner on to a dry cloth to wipe the screen.

Warning

This content is compiled from multiple sources and is provided for reference purposes only. It may not be complete or fully applicable to all situations. If you are unable to resolve your issue, please contact the product manufacturer or an authorized service provider for official support.