

## TV Control Switch & Operation

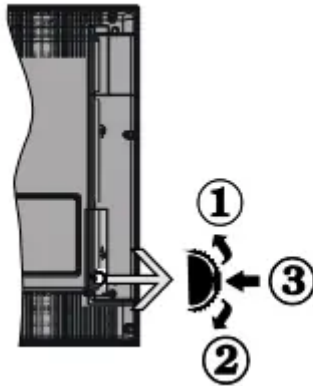

1. Up direction
2. Down direction
3. Volume / Info / Sources List selection and Standby-On switch

The Control button allows you to control the Volume / Programme / Source and Standby-On functions of the TV.

- To change volume: Increase the volume by pushing the button up. Decrease the volume by pushing the button down.
- To change channel: Press the middle of the button in, the information banner will appear on the screen. Scroll through the stored channels by pushing the button up or down.
- To change source: Press the middle of the button in twice (for the second time in total), the source list will appear on the screen. Scroll through the available sources by pushing the button up or down.
- To turn the TV off: Press the middle of the button in and hold it down for a few seconds, the TV will turn into standby mode.
- To turn on the TV: Press the middle of the button in, the TV will turn on.

Notes:

- If you turn the TV off, this cycle starts again beginning with the volume setting.
- Main menu OSD cannot be displayed via control button.

Operation with the Remote Control

- Press the Menu button on your remote control to display main menu. Use the directional buttons and OK button to navigate and set. Press Return/Back or Menu button to quit a menu screen.

## Input Selection

- Once you have connected external systems to your TV, you can switch to different input sources. Press the Source button on your remote control consecutively to select the different sources.

## Changing Channels and Volume

- You can change the channel and adjust the volume by using the Programme +/- and Volume +/- buttons on the remote.

## Using Main TV Menu

When the Menu button is pressed, the main TV menu will appear at the bottom of the screen. You can navigate through the menu items using the directional buttons on the remote. To select an item or see the sub-menu options of the highlighted menu press OK button. When you highlight a menu option some of the sub-menu items of this menu may appear on the upper side of the menu bar for quick access. To use a quick access item highlight it, press OK and set as desired using the Left/Right directional buttons. When finished press OK or Back/Return button to exit.

Press Exit button to close the main menu.

## Home

- When main menu is opened Home menu bar will be highlighted. The content of the Home menu can be customised by adding options from other menus. Just highlight an option and press the Down direction button on the remote. If you see Add to Home option you can add it to the Home menu. Same way you can delete or change the position of any item in the Home menu. Press the Down direction button and select the delete or move icon and press OK. In order to move a menu item use the Right and Left direction buttons to select the position that you want the item to move to and press OK.

## TV

2.1. Guide: You can access the electronic programme guide menu using this option. Refer to Electronic Programme Guide section for more information.

2.2. Channels: You can access the Channels menu using this option. Refer to Using the Channel List section for more information.

2.3. Timers:

- You can set timers for future events using the options of this menu. You can also review the previously created timers under this menu.
- To add a new timer select the Add Timer tab using the Left/Right buttons and press OK. Set the sub-menu options as desired and when finished press OK. A new timer will be created.

- To edit a previously created timer, highlight that timer, select the Edit Selected Timer tab and press OK. Change the sub-menu options as desired and press OK to save your settings.
- To cancel an already set timer, highlight that timer, select Delete Selected Timer tab and press OK. A confirmation message will be displayed. Highlight Yes and press OK to proceed. The timer will be cancelled.
- It is not possible to set timers for two or more events that will be broadcasted in different channels at the same time interval. In this case you will be asked to choose one of these timers and cancel others. Highlight the timer you want to cancel and press OK, Options menu will be displayed. Then highlight Set/Cancel and press OK to cancel that timer. You will have to save changes after that. In order to do that press OK, highlight Save Changes and press OK again.

2.4. Recordings: You can manage your recordings using the options of this menu. You can playback, edit, delete or sort previously recorded events. Highlight a tab by using the Left or Right direction button and press OK to see available options.

Recording Settings: You can also configure your recording preferences using the Settings tab in the Recordings menu. Highlight Settings tab by using Left or Right button and press OK. Then select the desired item in the sub-menu and set by using Left or Right button.

- Start early: You can set recording timer's starting time to start earlier by using this setting.
- End late: You can set recording timer's end time to end later by using this setting.
- Max Timeshift: This setting allows you to set the maximum duration for the timeshift recording. Available options are approximate and the actual recording time may change in practice depending on the broadcast. The reserved and free storage space values will change according to this setting. Make sure that you have enough free space otherwise instant recording may not be possible.
- Auto discard: You can set the Discard type as None, Oldest, Longest or Shortest. If it is not set to None, you can set the Unplayed option as Included or Excluded. These options determine the preferences for deleting the recordings in order to obtain more storage space for ongoing records.
- Hard disk information: You can view detailed information about the USB storage device connected to your TV. Highlight and press OK to see and press Back/Return to close.
- Format Disk: If you want to delete all files on the connected USB storage device and convert the disk format to FAT32, you can use this option. Press OK button while the Format Disk option is highlighted. A menu will appear on the screen, requiring you to enter the PIN(\*). After you enter the PIN, a confirmation message will be displayed. Select Yes and press OK to start formatting the USB storage device. Select No and press OK to cancel. (\*) Default PIN could have been set to 0000 or 1234. If you have

defined the PIN(is requested depending on the country selection) during the First Time Installation use the PIN that you have defined.

## Settings

- You can manage the settings of your TV using the options of this menu. Refer to Settings Menu Contents section for more information.

## Apps

- When your TV is connected to the Internet related contents will also be available, including Apps related contents. Using the Apps menu you can access and manage your applications. You can add new apps from the market or delete the existing ones. Refer to Apps section for more information.

## Source

- You can manage your input source references using the options of this menu. To change the current source highlight one of the options and press OK.

5.1. Source Settings: Edit the names, enable or disable selected source options.

## Inserting the Batteries into the Remote

- Remove the back cover to reveal the battery compartment. Insert two size AAA batteries. Make sure the (+) and (-) signs match (observe correct polarity). Do not mix old and new batteries. Replace only with same or equivalent type. Place the cover back on. A message will be displayed on the screen when the batteries are low and must be replaced.
- Note that when the batteries are low, the performance of the remote control may be impaired

## Power Connection

- **IMPORTANT:** The TV set is designed to operate on a 220-240V AC, 50 Hz supply. After unpacking, allow the TV set to reach the ambient room temperature before you connect the set to the mains. Plug the power cable to the mains socket outlet

## Antenna Connection

Connect the aerial or cable TV plug to the AERIAL INPUT (ANT.) socket or satellite plug to the SATELLITE INPUT (LNB) socket located on the rear side of the TV.

Rear side of the TV

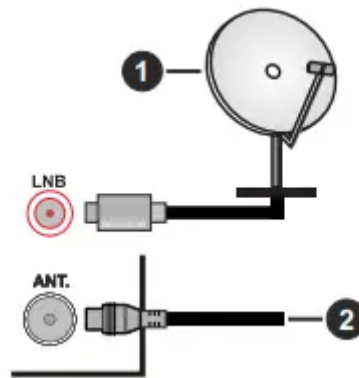

1. Satellite
2. Aerial or cable

If you want to connect a device to the TV, make sure that both the TV and the device are turned off before making any connection. After the connection is done, you can turn on the units and use them.

## Remote Control

1. Standby: Switches On / Off the TV
2. Source: Shows available broadcast and content sources
3. Numeric buttons: Switches the channel, enters a number or a letter in the text box on the screen.
4. Language: Switches among sound modes (analogue TV), displays and changes audio/subtitle language and turns subtitles on or off (digital TV, where available)
5. Menu: Displays TV menu
6. Volume +/-
7. Info: Displays information about on-screen content, shows hidden information (reveal - in TXT mode)
8. Directional buttons: Helps navigate menus, content etc. and displays the subpages in TXT mode when pressed Right or Left
9. OK: Confirms user selections, holds the page (in TXT mode), views Channels menu (DTV mode)
10. Back/Return: Returns to previous screen, previous menu, opens index page (in TXT mode)
11. Coloured Buttons: Follow the on-screen instructions for coloured button functions
12. Rakuten TV: Launches the Rakuten TV application
13. Rewind: Moves frames backwards in media such as movies

14. Record: Records programmes
15. Pause: Pauses the media being played, starts timeshift recording
16. Play: Starts to play selected media
17. Stop: Stops the media being played
18. Fast Forward: Moves frames forward in media such as movies
19. Netflix: Launches the Netflix application
20. Freeview Play: Connects to the Freeview Play platform where you can access available catch-up TV services
21. Exit: Closes and exits from displayed menus or returns to previous screen
22. Guide: Displays the electronic programme guide
23. Programme +/-
24. Text: Displays teletext (where available), press again to superimpose the teletext over a normal broadcast picture (mix)
25. Mute: Completely turns off the volume of the TV

## Connections

- See the illustrations on the left side. You can use YPbPr to VGA cable to enable YPbPr signal via VGA input. You cannot use VGA and YPbPr at the same time. To enable PC/YPbPr audio, you will need to use the back audio inputs with a YPbPr/PC audio cable for audio connection. When using the wall mounting kit (available from a third party in the market, if not supplied), we recommend that you plug all your cables into the back of the TV before mounting on the wall. Insert or remove the CI module only when the TV is SWITCHED OFF. You should refer to the module instruction manual for details of the settings. The/Each USB input of your TV supports devices up to 500mA. Connecting devices that have current value above 500mA may damage your TV. When connecting equipment using a HDMI cable to your TV, to guarantee sufficient immunity against parasitic frequency radiation, you have to use a high speed shielded (high grade) HDMI cable with ferrites
- If you want to connect a device to the TV, make sure that both the TV and the device are turned off before making any connection. After the connection is done, you can turn on the units and use them.

## Switching On/Off

To Switch the TV On: Connect the power cord to a power source such as a wall socket (220-240V AC, 50 Hz). To switch on the TV from standby mode either:

- Press the Standby button, Programme +/- or a numeric button on the remote control.
- Press the middle of the side function switch on the TV in.

To Switch the TV Off

- Press the Standby button on the remote control or press the middle of the side function switch on the TV in and hold it down for a few seconds, the TV will switch into standby mode.

To power down the TV completely, unplug the power cord from the mains socket.

Note: When the TV is switched into standby mode, the standby LED can blink to indicate that features such as Standby Search, Over Air Download or Timer is active. The LED can also blink when you switch on the TV from standby mode.

## First Time Installation

- When turned on for the first time, the language selection screen is displayed. Select the desired language and press OK. In the following steps of the installation guide, set your preferences using the directional buttons and OK button.
- On the second screen set your country preference. Depending on the Country selection you may be asked to set and confirm a PIN at this point. The selected PIN cannot be 0000.
- You have to enter it if you are asked to enter a PIN for any menu operation later. You can activate Store Mode option in the next step. This option will configure your TV's settings for store environment and depending on the TV model being used, the supported features of it may be displayed on the side of the screen as an info banner. This option is intended only for store use. It is recommended to select Home Mode for home use. This option will be available in Settings>System>More menu and can be turned off/on later. Make your selection and press OK to continue.
- Depending on the model of your TV and the country selection Privacy Settings menu may appear at this point. Using this menu you can set your privacy privileges. Highlight a feature and use Left and Right directional buttons to enable or disable. Read the related explanations displayed on the screen for each highlighted feature before making any changes. You can use Programme +/- buttons to scroll up and down to read the entire text. You will be able to change your preferences at any time later from the Settings>System>Privacy Settings menu. If the Internet Connection option is disabled Network/Internet Settings screen will be skipped and not displayed.

- Highlight Next and press OK button on the remote control to continue and the Network/ Internet Settings menu will be displayed. Please refer to Connectivity section to configure a wired or a wireless connection. If you want your TV to consume less power in standby mode, you can disable the Wake On option by setting it as Off. After the settings are completed highlight Next and press OK button to continue.
- On the next screen you need to agree to the terms and conditions of Freeview Play to make use of the related services. Scroll the page to read the entire text using the up/ down directional buttons or Programme +/- buttons. Highlight Yes and press OK on the remote to confirm and proceed. Highlight No and press OK to proceed without confirmation. For further requirements for Freeview Play services refer to the Freeview Play Platform section
- On next screen you can set broadcast types to be searched, set your encrypted channel searching and time zone (depending on the country selection) preferences. Additionally you can set a broadcast type as your favourite one. Priority will be given to the selected broadcast type during the search process and the channels of it will be listed on the top of the channel list. When finished, highlight Next and press OK to continue.

#### About Selecting Broadcast Type

- To turn a search option for a broadcast type highlight it and press OK. The checkbox next to the selected option will be checked. To turn the search option off clear the checkbox by pressing OK after moving the focus on the desired broadcast type option.
- Digital Aerial: If D. Aerial broadcast search option is turned on, the TV will search for digital terrestrial broadcasts after other initial settings are completed.
- Digital Cable: If D. Cable broadcast search option is turned on, the TV will search for digital cable broadcasts after other initial settings are completed. A message will be displayed before starting to search asking if you want to perform cable network search. If you select Yes and press OK you can select Network or set values such as Frequency, Network ID and Search Step on the next screen. If you select No and press OK you can set Start Frequency, Stop Frequency and Search Step on the next screen. When finished, highlight Next and press OK button to continue. Note: Searching duration will change depending on the selected Search Step.
- Satellite: If Satellite broadcast search option is turned on, the TV will search for digital satellite broadcasts after other initial settings are completed. Before satellite search is performed some settings should be made. Antenna Type menu will be displayed first. You can select Antenna Type as Direct, Single Satellite Cable or DiSEqC switch by using Left or Right buttons. After selecting your antenna type press OK to see the options to

proceed. Continue, Transponder list and Configure LNB options will be available. You can change the transponder and LNB settings using the related menu options.

- Direct: If you have a single receiver and a direct satellite dish, select this antenna type. Press OK to continue. Select an available satellite on the next screen and press OK to scan for services.
- Single Satellite Cable: If you have multiple receivers and a single satellite cable system, select this antenna type. Press OK to continue. Configure settings by following instructions on the next screen. Press OK to scan for services.
- DiSEqC switch: If you have multiple satellite dishes and a DiSEqC switch, select this antenna type. Then set the DiSEqC version and press OK to continue. You can set up to four satellites (if available) for version v1.0 and sixteen satellites for version v1.1 on the next screen. Press OK button to scan the first satellite in the list.
- Analogue: If Analogue broadcast search option is turned on, the TV will search for analogue broadcasts after other initial settings are completed. After the initial settings are completed TV will start to search for available broadcasts of the selected broadcast types.
- While the search continues current scan results will be displayed at the bottom of the screen. After all the available stations are stored, Channels menu will be displayed. You can edit the channel list according to your preferences using the Edit tab options or press the Menu button to quit and watch TV.
- While the search continues a message may appear, asking whether you want to sort channels according to the LCN(\*). Select Yes and press OK to confirm.

(\*) LCN is the Logical Channel Number system that organizes available broadcasts in accordance with a recognizable channel number sequence (if available).

Note: Do not turn off the TV while initializing first time installation. Note that, some options may not be available depending on the country selection

## Media Playback via USB Input

- You can connect 2.5" and 3.5" inch (HDD with external power supply) external hard disk drives or USB memory stick to your TV by using the USB inputs of the TV.
- IMPORTANT! Back up the files on your storage devices before connecting them to the TV. Manufacturer will not be responsible for any file damage or data loss. Certain types of USB devices (e.g. MP3 Players) or USB hard disk drives/memory sticks may not be compatible with this TV. The TV supports FAT32 and NTFS disk formatting but recording will not be available with NTFS formatted disks.

- While formatting USB hard drives which have more than 1TB (Tera Byte) storage space you may experience some problems in the formatting process.
- Wait a little while before each plugging and unplugging as the player may still be reading files. Failure to do so may cause physical damage to the USB player and the USB device itself. Do not pull out your drive while playing a file.
- You can use USB hubs with your TV's USB inputs. External power supplied USB hubs are recommended in such a case.
- It is recommended to use the TV's USB input(s) directly, if you are going to connect a USB hard disk.
- Note: When viewing image files the Media Browser menu can only display 1000 image files stored on the connected USB device.

## USB Recording

### Recording a Programme

- **IMPORTANT:** When using a new USB hard disk drive, it is recommended that you first format the disk using your TV's Format Disk option in the TV>Recordings>Settings menu. To record a programme, you should first connect a USB disk to your TV while the TV is switched off. You should then switch on the TV to enable the recording feature. To use recording your USB drive should have 2 GB free space and be USB 2.0 compatible. If the USB drive is not compatible an error message will be displayed. To record long duration programmes such as movies, it is recommended to use USB Hard disk drives (HDD's). Recorded programmes are saved into the connected USB disk. If desired, you can store/copy recordings onto a computer; however, these files will not be available to be played on a computer. You can play the recordings only via your TV.
- Lip Sync delay may occur during the timeshifting. Radio record is supported. The TV can record programmes up to ten hours.
- Recorded programmes are split into 4GB partitions. If the writing speed of the connected USB disk is not sufficient, the recording may fail and the timeshifting feature may not be available. It is recommended to use USB hard disk drives for recording HD programmes.
- Do not pull out the USB/HDD during a recording. This may harm the connected USB/HDD.
- If the AC cord is unplugged while there is an active USB-recording timer setting, it will be cancelled. Multipartition support is available. A maximum of two different partitions are supported. The first partition of the USB disk is used for USB Recording ready features. It also must be formatted as the primary partition to be used for the USB Recording ready features.

- Some stream packets may not be recorded because of signal problems, as a result sometimes videos may freeze during playback.
- Record, Play, Pause, Display (for playlist dialogue) keys can not be used when teletext is on. If a recording starts from timer when teletext is on, teletext is automatically turned off. Also teletext usage is disabled when there is an ongoing recording or playback

## **Timeshift Recording**

- Press Pause button while watching a broadcast to activate timeshifting mode. In timeshifting mode, the programme is paused and simultaneously recorded to the connected USB disk.
- Press Play button again to resume the paused programme from where you stopped.
- Press the Stop button to stop timeshift recording and return to the live broadcast.
- Timeshift cannot be used while in radio mode.
- You can use the timeshift rewind feature after resuming normal playback or fast forward option.

## **Instant Recording**

- Press Record button to start recording an event instantly while watching a programme. You can press Record button on the remote control again to record the next event after selecting the next programme from within the electronic programme guide. Press Stop button to cancel instant recording.
- You can not switch broadcasts during the recording mode. While recording a programme or during the timeshifting, a warning message appears on the screen if your USB device speed is not sufficient.

## **Watching Recorded Programmes**

- Select Recordings from the TV menu. Select a recorded item from the list (if previously recorded). Press the OK button to view the Options menu. Select an option then press OK button.
- Note: Viewing main menu and menu items will not be available during the playback.
- Press the Stop button to stop a playback and return to the Recordings

## **Slow Forward**





- If you press Pause button while watching recorded programmes, the slow forward feature will be available. You can use Fast Forward button to slow forward. Pressing Fast Forward button consecutively will change slow forwarding speed.

## Recording Configuration

- Select the Settings tab in the TV>Recordings menu to configure the recording settings and press OK.
- Format Disk: You can use the Format Disk option for formatting the connected USB disk. Your PIN will be required to use the Format Disk feature.
- Note: Default PIN could have been set to 0000 or 1234. If you have defined the PIN(is requested depending on the country selection) during the First Time Installation use the PIN that you have defined.
- IMPORTANT: Formatting your USB drive will erase ALL the data on it and it's file system will be converted to FAT32. In most cases operation errors will be fixed after a format but you will lose ALL your data.
- If "USB disk writing speed too slow to record" message is displayed on the screen while starting a recording, try restarting the recording. If you still get the same error, it is possible that your USB disk does not meet the speed requirements. Try connecting another USB disk.

## Media Browser

- You can play back music and movie files and display photo files stored on a USB storage device by connecting it to your TV. Connect a USB storage device to one of the USB inputs located on the side of the TV.
- After connecting a USB storage device to your TV Media Browser menu will be displayed on the screen. You can access the content of the connected USB device any time later from the Sources menu. Select the related USB input option from this menu and press OK. Then select the file of your choice and press OK to display or play it back.
- You can set your Media Browser preferences by using the Settings menu. Settings menu can be accessed via the information bar which is displayed on the bottom of the screen when pressed the Info button while playing back a video file or displaying a picture file. Press the Info button, highlight the gear wheel symbol positioned on the right side of the information bar and press OK. Picture Settings, Sound Settings, Media Browser Settings and Options menus will be available. The contents of these menus may change according to the type of the currently open media file. Only Sound Settings menu will be available while playing back audio files.

<b>Loop/Shuffle Mode Operation</b>	
Start playback and activate 	All files in the list will be continuously played in original order
Start playback and activate 	The same file will be played continuously (repeat)
Start playback and activate 	All files in the list will be played once in random order
Start playback and activate  	All files in the list will be continuously played in the same random order

- To use the functions on the information bar highlight the symbol of the function and press OK. To change the status of a function highlight the symbol of the function and press OK as much as needed. If the symbol is marked with a red cross, that means it is deactivated.

#### Custom Boot Up Logo

- You can personalize your TV and see your favourite image or photo on the screen each time your TV boots up. To do this, copy your favourite image files into a USB disk and open them in the Media Browser. Select USB input from the Sources menu and press OK. When you have chosen the desired image, highlight it and press OK to view it in full screen. Press the Info button, highlight the gear wheel symbol on the information bar and press OK. Select Options and press OK to enter. Set Boot Logo option will be available. Highlight it and press OK again to choose the image as custom boot logo. A confirmation message will be displayed. Select Yes and press OK again. If the image is suitable(\*) you will see it on the screen during the TV's next boot up.
- Note: If you perform a First Time Installation the TV will return to using the default logo, if any.

(\*) Images should have an aspect ratio of 16:9 and they should be in .jpg, .jpeg or .jpe file formats. Only files with sizes no greater than 300KB are supported. The image cannot be set as boot logo, which's resolution doesn't appear on the info banner.

#### FollowMe TV

- With your mobile device you can stream the current broadcast from your smart TV using the FollowMe TV feature. Install the appropriate Smart Center application to your mobile device. Start the application.

- For further information on using this feature refer to the instructions of the application you use.
- Note: Depending on model, your TV may not support this function. The application may not be compatible with all mobile devices. UHD (4K, Ultra HD) channels are not supported and both of the devices must be connected to the same network

## CEC

- This function allows to control the CEC-enabled devices, that are connected through HDMI ports by using the remote control of the TV.
- The CEC option in the Settings>System>More menu should be set as Enabled at first. Press the Source button and select the HDMI input of the connected CEC device from the Sources List menu. When new CEC source device is connected, it will be listed in source menu with its own name instead of the connected HDMI ports name(such as DVD Player, Recorder 1 etc.).
- The TV remote is automatically able to perform the main functions after the connected HDMI source has been selected. To terminate this operation and control the TV via the remote again, press and hold the “0- Zero” button on the remote control for 3 seconds.
- You can disable the CEC functionality by setting the related option under the Settings>System>More menu accordingly
- The TV supports ARC (Audio Return Channel). This feature is an audio link meant to replace other cables between the TV and an audio system (A/V receiver or speaker system).
- When ARC is active, the TV does not mute its other audio outputs automatically. You will need to decrease TV volume to zero manually if you wish to hear the ARC audio only (same as optical or co-axial digital audio outputs). If you want to change connected device’s volume level, you should select that device from the source list. In that case volume control keys are directed to connected audio device.
- Note: ARC is supported only via the HDMI2 input

### System Audio Control

- Allows an Audio Amplifier/Receiver to be used with the TV. The volume can be controlled using the remote control of the TV. To activate this feature set the Speakers option in the Settings>System>More menu as Amplifier. The TV speakers will be muted and the sound of the watched source will be provided from the connected sound system.
- Note: The audio device should support System Audio Control feature and CEC option should be set as Enabled.

## E-Manual

- You can find instructions for your TV's features in the E-Manual.
- To access the E-Manual, enter Settings menu, select Manuals and press OK. For quick access press Menu button and then Info button.
- By using the directional buttons select a desired category. Every category includes different topics. Select a topic and press OK to read instructions. To close the E-Manual screen press the Exit or Menu button.
- Note: Depending on model, your TV may not support this function. The contents of the E-Manual may vary according to the model.

## Settings Menu Contents

### Picture Menu Contents

1. Mode: You can change the picture mode to suit your preference or requirements. Picture mode can be set to one of these options: Cinema, Game(optional), Sports, Dynamic and Natural.

- Contrast: Adjusts the light and dark values on the screen.
- Brightness: Adjusts the brightness values on the screen.
- Sharpness: Sets the sharpness value for the objects displayed on the screen.
- Colour: Sets the colour value, adjusting the colours.

2. Energy Saving: For setting the Energy Saving to Custom, Minimum, Medium, Maximum, Auto, Screen Off or Off. Note: Available options may differ depending on the selected Mode

- Backlight: This setting controls the backlight level. The backlight function will be inactive if the Energy Saving is set to an option other than Custom.

3. Advanced Settings

- Dynamic Contrast: You can change the dynamic contrast ratio to desired value.
- Noise Reduction: If the signal is weak and the picture is noisy, use the Noise Reduction setting to reduce the amount of noise.
- Colour Temp: Sets the desired colour temperature value. Cool, Normal, Warm and Custom options are available
  - White Point: If the Colour Temp option is set as Custom, this setting will be available. Increase the 'warmth' or 'coolness' of the picture by pressing Left or Right buttons.

- Picture Zoom: Sets the desired image size format.
  - Picture Shift :This option may be available depending on the Picture Zoom setting. Highlight and press OK, then use directional buttons to shift the picture upwards or downwards.
- Film Mode: Films are recorded at a different number of frames per second to normal television programmes. Turn this feature on when you are watching films to see the fast motion scenes clearly.
- Skin Tone: Skin tone can be changed between -5 and 5.
- Colour Shift: Adjust the desired colour tone.
- HDMI Full Range: While watching from a HDMI source, this feature will be visible. You can use this feature to enhance blackness in the picture.

#### 4. PC Position: Appears only when the input source is set to VGA/PC.

- Autoposition: Automatically optimizes the display. Press OK to optimize.
- H Position: This item shifts the image horizontally to the right hand side or left hand side of the screen.
- V Position: This item shifts the image vertically towards the top or bottom of the screen.
- Dot Clock: Dot Clock adjustments correct the interference that appear as vertical banding in dot intensive presentations like spreadsheets or paragraphs or text in smaller fonts.
- Phase: Depending on the input source(computer etc.) you may see a hazy or noisy picture on the screen. You can use phase to get a clearer picture by trial and error.

#### 5. Reset

- Resets the picture settings to factory default settings (except Game mode).

### Sound Menu Contents

- Volume: Adjusts the volume level.
- Equalizer: Selects the equalizer mode. Custom settings can be made only when in User mode.
- Balance: Adjusts whether the sound comes from the left or right speaker.
- Headphone: Sets headphone volume. Please ensure before using headphones that the headphone volume is set to a low level, to prevent damage to your hearing.
- Sound Mode: You can select a sound mode (If the viewed channel supports).
- Bluetooth (optional): Press OK to open the Bluetooth menu screen. Using this screen you can discover and connect the Bluetooth wireless technology enabled sound devices to your TV.

- AVL (Automatic Volume Limiting): Sets the sound to obtain fixed output level between programmes.
- Headphone/Lineout: When you connect an external amplifier to your TV using the headphone jack, you can select this option as Lineout. If you have connected headphones to the TV, set this option as Headphone. Please ensure before using headphones that this menu item is set to Headphone. If it is set to Lineout, the output from the headphone socket will be set to maximum which could damage your hearing.
- Dynamic Bass (optional): Enables or disables the Dynamic Bass.
- DTS TruSurround: Enables or disables the DTS TruSurround.
- DTS DRC: Dynamic Range Control provides gain adjustment of the source to maintain suitable audible range at both low and high playback levels. Enable or disable the DTS DRC by setting as On or Off.
- Digital Out: Sets digital out audio type.

## Network Menu Contents

- Network Type: Disable the network connection or change the connection type.
- Scan Wireless Networks: Start a search for wireless networks. This option will be available if the Network Type is set as Wireless Device.
- Press WPS on your wifi router: If your modem/router device has WPS, you can directly connect to it using this option. Highlight this option and press OK. Go to your modem/router device and press the WPS button on it to make the connection. This option will be available if the Network Type is set as Wireless Device.
- Internet Speed Test: Start a speed test to check your connection bandwidth. The result will be displayed on the screen when finished.
- Advanced Settings: Change the IP and DNS configurations of your TV.
- Wake On: Enable or disable this feature by setting it as On or Off.

Note: For detailed information on the options of this menu refer to the Connectivity section

## Installation Menu Contents

- Automatic channel scan (Retune): Displays automatic tuning options. D. Aerial: Searches and stores aerial DVB stations. D. Cable: Searches and stores cable DVB stations. Analogue: Searches and stores analogue stations. Satellite: Searches and stores satellite stations.
- Manual channel scan: This feature can be used for direct broadcast entry.
- Network channel scan: Searches for the linked channels in the broadcast system. D. Aerial: Searches for aerial network channels. D. Cable: Searches for cable network channels. Satellite: Searches for satellite network channels.

- Analogue fine tune: You can use this setting for fine tuning analogue channels. This feature is not available if no analogue channels are stored and if currently watched channel is not an analogue channel.
- Satellite: Settings Displays satellite settings. Satellite list: Displays available satellites. You can Add, Delete satellites or Edit satellite settings on the list. Antenna installation: You can change satellite antenna settings and/or start a satellite scan.
- Installation Settings (optional): Displays installation settings menu. Standby Search (\*): Your TV will search for new or missing channels while in standby. Any new found broadcasts will be shown. Dynamic Channel Update(\*): If this option is set as Enabled, the changes on the broadcasts such as frequency, channel name, subtitle language etc., will be applied automatically while watching. (\*) Availability depends on model.
- Clear Service List: Use this setting to clear channels stored. This setting is visible only when the Country option is set to Denmark, Sweden, Norway or Finland.
- Select Active Network: This setting allows you to select only the broadcasts within the selected network to be listed in the channel list. This feature is available only for the country option of Norway.
- Signal Information: You can use this menu item to monitor signal related information such as signal level/ quality, network name etc for available frequencies.
- First time installation: Deletes all stored channels and settings, resets TV to factory settings.

## System Menu Contents

1. Conditional Access: Controls conditional access modules when available.
2. Language: You may set a different language depending on the broadcaster and the country.
3. Privacy Settings (\*): Manage your privacy privileges for smart TV related applications. Press OK to enter the menu and set according to your preferences.
4. Parental: Enter correct password to change parental settings. You can easily adjust Menu Lock, Maturity Lock, Child Lock or Guidance in this menu. You can also set a new PIN or change the Default CICAM PIN using the related options. Note: Some menu options may not be available depending on the country selection in the First Time Installation. Default PIN could have been set to 0000 or 1234. If you have defined the PIN(is requested depending on the country selection) during the First Time Installation use the PIN that you have defined.
5. Date/Time: Sets date and time.
6. Sources: Edit the names, enable or disable selected source options.
7. Accessibility: Displays accessibility options of the TV
  - Hard of Hearing Enables any special feature sent from the broadcaster.

- **Audio Description:** A narration track will be played for the blind or visually impaired audience. Press OK to see all available Audio Description menu options. This feature is available only if the broadcaster supports it. Note: Audio description sound feature is not available in recording or time shifting mode

8. **Netflix:** If this feature is supported by your TV, you can view your ESN(\*) number and deactivate Netflix. (\*) ESN number is a unique ID number for Netflix, created especially to identify your TV.

9. **More:** Displays other setting options of the TV.

- **Menu Timeout:** Changes timeout duration for menu screens.
- **Standby LED:** If set as Off the standby LED will not light up when the TV is in standby mode.
- **HBBTV (\*):** You can enable or disable this feature by setting it as On or Off.
- **Software Upgrade:** Ensures that your TV has the latest firmware. Press OK to see the menu options.
- **Application Version:** Displays current software version.
- **Subtitle Mode:** This option is used to select which subtitle mode will be on the screen (DVB subtitle / Teletext subtitle) if both is available. Default value is DVB subtitle. This feature is available only for the country option of Norway.
- **Auto TV OFF:** Sets the desired time for the TV to automatically go into standby mode when not being operated.
- **Biss Key:** Biss is a satellite signal scrambling system that is used for some broadcasts. If you need to enter Biss key on a broadcast, you can use this setting. Highlight Biss Key and press OK to enter keys on the desired broadcast.
- **Store Mode:** Select this mode for store display purposes. Whilst Store Mode is enabled, some items in the TV menu may not be available.
- **AVS (Audio Video Sharing):** AVS feature allows you to share files stored on your smartphone or tablet pc. If you have a compatible smartphone or tablet pc and the appropriate software is installed, you can share/play photos on your TV. See instructions of your sharing software for more information.
- **Power Up Mode:** This setting configures the power up mode preference. Last State and Standby options are available.
- **Virtual Remote:** Enable or disable the virtual remote feature.
- **CEC:** With this setting you can enable and disable CEC functionality completely. Press Left or Right button to enable or disable the feature
- **CEC Auto Power On:** This function allows the connected HDMI-CEC compatible device to turn on the TV and switch to its input source automatically. Press Left or Right button to enable or disable the feature.

- **Speakers:** To hear the TV audio from the connected compatible audio device set as Amplifier. You can use the remote control of the TV to control the volume of the audio device.
- **Smart Remote (optional):** Press OK to open the Smart Remote menu screen. Using this screen you can discover and connect the Bluetooth wireless technology enabled remote controller devices to your TV.
- **Show All Cookies (\*):** Displays all saved cookies.
- **Delete All Cookies (\*):** Deletes all saved cookies.
- **OSS:** Displays Open Source Software license information.

(\*) These features may not be available depending on the model of your TV and the selected country in the First Time Installation.

## General TV Operation

### Using the Channel List

The TV sorts all stored stations in the channel list. You can edit this channel list, set favourites or set active stations to be listed by using the Channels menu options. Press the OK button to open the channel list. You can filter the listed channels or make advanced changes in the current list using the Filter and Edit tab options. Highlight the tab you want and press OK to see available options.

#### Managing the Favourite Lists

- You can create four different lists of your favourite channels. Enter the TV>Channels menu or press the OK button in order to open the Channels menu. Highlight the Edit tab and press OK to see the editing options and select the Tag/Untag channel option. Select the desired channel on the list by pressing the OK button while the channel is highlighted. You can make multiple choices. You can also use the Tag/ Untag all option to select all channels on the list. Then press Back/Return button to return to the Edit menu options. Select Add/Remove Favourites option and press the OK button again. Favourite channel list options will be displayed. Set the desired list option to On. The selected channel/s will be added to the list. In order to remove a channel or channels from a favourite list follow the same steps and set the desired list option to Off.
- You can use the filtering function in the Channels menu to filter the channels in the channel list permanently according to your preferences. For instance, using the options of the Filter tab, you can set one of your four favourite lists to be displayed every time the channel list is opened.

## Configuring Parental Settings

- The Parental menu options can be used to prohibit users from viewing of certain programmes, channels and using of menus. These settings are located in the Settings>System>Parental menu.
- To display parental lock menu options, a PIN should be entered. After coding the correct PIN, Parental menu will be displayed.
- Menu Lock: This setting enables or disables access to all menus or installation menus of the TV.
- Guidance: This setting enables or disables access some of the MHEG applications. Disabled applications can be released by entering the right PIN.
- Internet Lock: If this option is set to On, the internet using applications will be disabled. Set to Off to release these applications again.
- Set PIN: Defines a new PIN number. Default CICAM PIN: This option will appear as greyed out if no CI module is inserted into the CI slot of the TV. You can change the default PIN of the CI CAM using this option.
- Note: Default PIN could have been set to 0000 or 1234. If you have defined the PIN(is requested depending on the country selection) during the First Time Installation use the PIN that you have defined.
- Some options may not be available depending on the model and/or on the country selection in the First Time Installation.

## Electronic Programme Guide

- By means of electronic programme guide function of your TV you can browse the event schedule of the currently installed channels on your channel list. It depends on the related broadcast whether this feature is supported or not.
- To access the programme guide, press the Guide button on your remote. You can also use the Guide option under TV menu.
- There are 2 different types of schedule layouts available, Timeline Schedule and Now/Next. To switch between these layouts highlight the tab with the name of the alternative layout on the upper side of the screen and press OK. Use the directional buttons to navigate through the programme guide.
- Use the Back/Return button to use the tab options on the upper side of the screen

### Timeline Schedule

- In this layout option, all events of the listed channels will be displayed by timeline. You can use the directional buttons to scroll through the list of the events. Highlight an event and press OK to display event options menu.

- Press Back/Return button to use available tab options. Highlight Filter tab and press OK to see the filtering options. To change the layout highlight Now/Next and press OK. You can use the Previous Day and Next Day options to display the events of the previous and next day.
- Highlight Extras tab and press OK to access below options.
  - Highlight Genre: Displays Highlight Genre menu. Select a genre and press OK. The events in the programme guide matching the selected genre will be highlighted.
  - Guide Search: Displays searching options. Using these options, you can search the programme guide database in accordance with the selected criteria. Matching results will be listed.
  - Now: Displays current event of the highlighted channel.
  - Zoom: Highlight and press OK to see events in a wider time interval.

#### Now/Next Schedule

- In this layout option, only the current and next events of the listed channels will be displayed. You can use the directional buttons to scroll through the list of the events.
- Press Back/Return button to use available tab options. Highlight Filter tab and press OK to see the filtering options. To change the layout highlight Timeline Schedule and press OK.

#### Event Options

- Use the directional buttons to highlight an event and press OK button to display Options menu. The following options are available.
- Select Channel: Using this option, you can switch to the selected channel in order to watch it. The programme guide will be closed.
- More Info: Display detailed information on the selected event. Use up and down directional buttons to scroll through the text.
- Set Timer on Event / Delete Timer on Event: Select Set Timer on Event option and press OK. You can set timers for future events. To cancel an already set timer, highlight that event and press the OK button. Then select Delete Timer on Event option. The timer will be cancelled.
- Record / Delete Rec. Timer: Select the Record option and press the OK button. If the event is going to be broadcasted at a future time, it will be added to Timers list to be recorded. If the selected event is being broadcasted at the moment, recording will start immediately.
- To cancel an already set record timer, highlight that event and press the OK button and select the option Delete Rec. Timer. The record timer will be cancelled. **IMPORTANT:**

Connect a USB disk to your TV while the TV is switched off. You should then switch on the TV to enable the recording feature.

- Notes: You cannot switch to any other channel while there is an active recording or timer on the current channel.
- It is not possible to set timer or record timer for two or more individual events at the same time interval.

### Integrated Catch-Up Services

- You can enjoy Freeview Play catch-up TV services that work directly through the electronic programme guide. Whilst you are on a channel use the directional buttons to scroll back in time through the timelinebased guide. You will see contents from last few days. Available catch-up contents may change according to broadcasters and will be marked with a play icon. Highlight the content you want to play back and press the OK button.
- Make sure that your TV is connected to your home network in order to use the catch-up services. For further information regarding this matter and other requirements for Freeview Play services refer to the Connectivity and Freeview Play Platform sections

## Teletext Services (where available)

- Press the Text button to enter. Press again to activate mix mode, which allows you to see the teletext page and the TV broadcast at the same time. Press once more to exit. If available, sections in the teletext pages will become colour-coded and can be selected by pressing the coloured buttons. Follow the instructions displayed on the screen.
- Digital Teletext: Press the Text button to view digital teletext information. Operate it with the coloured buttons, cursor buttons and the OK button. The operation method may differ depending on the contents of the digital teletext. Follow the instructions displayed on the digital teletext screen. When the Text button is pressed again, the TV returns to television broadcast.

## MHEG Teletext

With digital terrestrial broadcasting (DVB-T), in addition to pictures and sound, you can also view digital teletext. Digital teletext is sometimes broadcast at the same time with the normal broadcasting.

- Press the Text or Red button
- The digital teletext information appears
- Operate it with the coloured buttons, directional buttons and OK button

The operation method may differ depending on the contents of the digital teletext. Follow the instructions displayed on digital teletext screen. Press the Text button to return to television broadcast.

## **BBC Red Button+ (RB+)**

- While watching BBC channels, press the Red button or Text button to access Red Button+ services provided by the BBC. On the opening page you can access to BBC's main services such as BBC iPlayer, BBC News, BBC Sport and many others. There are also links to the home pages of the related applications available. Use the navigation buttons on the TV's remote control to move through the application. Press Exit button to close and exit.

## **Software Upgrade**

Your TV is capable of finding and updating the firmware automatically via the broadcast signal or via Internet.

Software upgrade search via user interface

- On the main menu select Settings>System and then More. Navigate to Software upgrade and press the OK button. Then select Scan for upgrade and press OK button to check for a new software upgrade.
- If a new upgrade is found, it starts to download the upgrade. After the download is completed, a warning will be displayed, press OK button to complete software upgrade process and restart TV.

3 AM search and upgrade mode

- Your TV will search for new upgrades at 3:00 o'clock if Automatic scanning option is set to Enabled and if the TV is connected to an aerial signal or to Internet. If a new software is found and downloaded successfully, it will be installed at the next power on.
- Note: Do not unplug the power cord while led is blinking during the reboot process. If the TV fails to come on after the upgrade, unplug, wait for two minutes then plug it back in.
- All updates are automatically controlled. If a manual search is carried out and no software is found then this is the current version.

## **Troubleshooting & Tips**

1. TV will not turn on:

- Make sure the power cord is plugged in securely to a wall outlet. Press the Power button on the TV.

## 2. Poor picture

- Check if you have correctly tuned the TV.
- Low signal level can cause picture distortion. Please check antenna connections.
- Check if you have entered the correct channel frequency if you have performed manual tuning.

## 3. No picture

- TV is not receiving any signal. Make sure the correct source has been selected.
- Is the antenna connected properly?
- Is the antenna cable damaged?
- Are suitable plugs used to connect the antenna?
- If you are in doubt, consult your dealer.

## 4. No sound

- Check if the TV sound is muted. Press the Mute button or increase the volume to check.
- Sound is coming from only one speaker. Check the balance settings from Sound menu.

## 5. Remote control - no operation

- The batteries may be exhausted. Replace the batteries.
- The batteries maybe inserted incorrectly. Refer to the section “Inserting the Batteries into the Remote”.

## 6. No signal on an input source

- It is possible that no device is connected.
- Check the AV cables and connections from your device.
- Check the device is switched on.

## 7. Recording unavailable

- To record a programme, you should first correctly connect a USB storage device to your TV, while the TV is switched off. You should then switch on the TV to enable the recording feature. If you cannot record, check the storage device is correctly formatted and there is sufficient space.

## 8. USB is too slow

- If a “USB storage device writing speed too slow to record” message is displayed on the screen while starting a recording, try restarting the recording. If you still get the same error, it is possible that your USB storage device does not meet the speed requirements. Try using a different USB storage device.

## PC Input Typical Display Modes

The following table is an illustration of some of the typical video display modes. Your TV may not support all resolutions.

## AV and HDMI Signal Compatibility

(X: Not Available, O: Available) In some cases a signal on the TV may not be displayed properly. The problem may be an inconsistency with standards from the source equipment (DVD, Set-top box, etc. ). If you do experience such a problem please contact your dealer and also the manufacturer of the source equipment.

## Connectivity

### Wired Connectivity

To Connect to a Wired Network

- You must have a modem/router connected to an active broadband connection.
- Connect your TV to your modem/router via an Ethernet cable. There is a LAN port at the rear (back) of your TV.

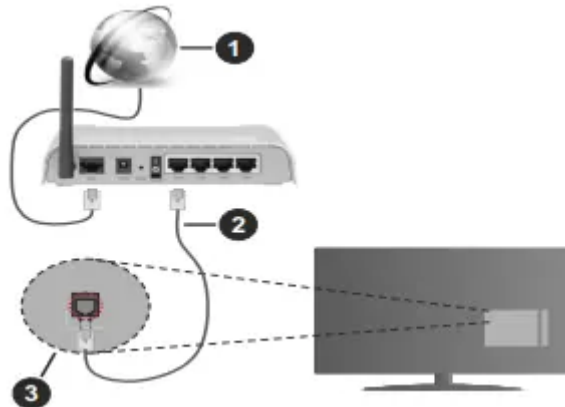

1. Broadband ISP connection
2. LAN (Ethernet) cable
3. LAN input on the rear side of the TV

To configure wired settings refer to the Network section in the Settings menu.

- You might be able to connect your TV to your LAN depending on your network's configuration. In such a case, use an Ethernet cable to connect your TV directly to the network wall outlet.

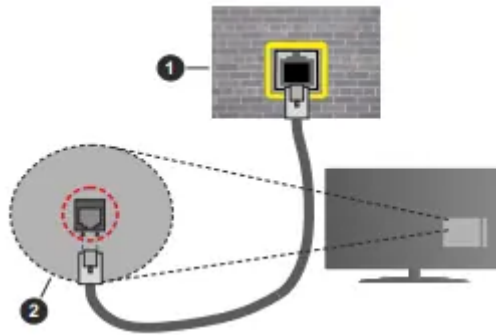

1. Network wall socket
2. LAN input on the rear side of the TV

### Configuring Wired Device Settings Network Type

- The Network Type can be selected as Wired Device, Wireless Device or Disabled, in accordance with the active connection to the TV set. Select this as Wire Device if you are connecting via an Ethernet cable.

Internet Speed Test: Highlight Internet Speed Test and press the OK button. TV will check the internet connection bandwidth and display the result when complete.

### Advanced Settings

- Highlight Advanced Settings and press the OK button. On the next screen you can change the IP and DNS settings of the TV. Highlight the desired one and press Left or Right button to change the setting from Automatic to Manual. Now you can enter the Manual IP and / or Manual DNS values. Select the related item in the drop down menu and enter the new values using the numeric buttons of the remote. Highlight Save and press the OK button to save settings when complete

## Wireless Connectivity

### To Connect to a Wireless Network

- The TV cannot connect to the networks with a hidden SSID. To make your modem's SSID visible, you should change your SSID settings via the modem's software.



1. Broadband ISP connection A Wireless-N router (IEEE 802.11a/b/g/n) with simultaneous 2.4 and 5 GHz bands is designed to increase bandwidth. These are optimized for smoother and faster HD video streaming, file transfers and wireless gaming.

- The frequency and channel differ depending on the area.
- The transmission speed differs depending on the distance and number of obstructions between the transmission products, the configuration of these products, the radio wave conditions, the line traffic and the products that you use. The transmission may also be cut off or may get disconnected depending on the radio wave conditions, DECT phones or any other WLAN 11b appliances. The standard values of the transmission speed are the theoretical maximum values for the wireless standards. They are not the actual speeds of data transmission.
- The location where the transmission is most effective differs depending on the usage environment.
- The Wireless feature of the TV supports 802.11 a,b,g & n type modems. It is highly recommended that you should use the IEEE 802.11n communication protocol in order to avoid any possible problems while watching videos.
- You must change your modem's SSID when there are any other modems around with the same SSID. You can encounter connection problems otherwise. Use a wired connection if you experience problems with a wireless connection.

#### Configuring Wireless Device Settings

- Open the Network menu and select Network Type as Wireless Device to start connection process.
- Highlight Scan Wireless Networks option and press OK to start a search for available wireless networks. All found networks will be listed. Highlight your desired network from the list and press OK to connect.
- Note: If the modem supports N mode, you should set N mode settings.

- If the selected network is password-protected, enter the correct key by using the virtual keyboard. You can use this keyboard via the directional buttons and the OK button on the remote control.
- Wait until the IP address is shown on the screen.
- This means that the connection is now established. To disconnect from a wireless network, highlight Network Type and press Left or Right buttons to set as Disabled.
- If your router has WPS, you can directly connect to the modem/router without entering a password or adding the network first. Highlight Press WPS on your wifi router option and press OK. Go to your modem/router device and press the WPS button on it to make the connection. You will see a connection confirmation on your TV once the devices have paired. Select OK to proceed. No further configuration is required. Highlight Internet Speed Test and press the OK button to check your internet connection speed.
- Highlight Advanced Settings and press the OK button to open the advanced setting menu. Use directional and numeric buttons to set. Highlight Save and press the OK button to save settings when complete.

#### Other Information

- The status of the connection will be displayed as Connected or Not Connected and the current IP address, if a connection is established.

#### Connecting to your mobile device via WLAN

- If your mobile device has WLAN feature, you can connect it to your TV via a router, in order to access the content in your device. For this, your mobile device must have an appropriate sharing software. Connect your TV to your router following the steps mentioned in the sections above. Afterwards, connect your mobile device to the router and then activate the sharing software on your mobile device. Then, select files that you want to share with your TV. If the connection is established correctly, you will be able to access the shared files installed on your mobile device via the AVS(audio video sharing) feature of your TV. Highlight the AVS option in the Sources menu and press OK, available media server devices in the network will be displayed. Select your mobile device and press the OK button to continue.
- If available, you can download a virtual remote controller application from the server of your mobile device application provider. Note: This feature may not be supported on all mobile devices.

#### Wake ON

- Wake-on-LAN (WoL) and Wake-on-Wireless LAN (WoWLAN) are standards that allow a device to be turned on or woken up by a network message. The message is sent to the device by a program executed on a remote device connected to the same local area network, such as a smartphone.

- Your TV is WoL and WoWLAN compatible. This feature might be disabled during the First Time Installation process. To enable this feature set the Wake On option in the Network menu as On. It is necessary that both the device, from which the network message will be sent to the TV, and the TV are connected to the same network. Wake On feature is only supported for Android OS devices and can only be used via YouTube and Netflix applications.
- In order to use this feature the TV and the remote device should be connected at least once while the TV is on. If the TV is powered off, the connection should be re-established, the next time it is switched on. Otherwise this feature will be unavailable. This does not apply, when the TV is switched into the standby mode.
- The performance of some devices in the market, may vary due to the software architecture. In order to use Wake On feature with a better performance, please make sure that your device has latest firmware version.
- If you want your TV to consume less power in standby mode, you can disable this feature by setting the Wake On option as Off.

## Wireless Display

Wireless Display is a standard for streaming video and sound content. This feature provides the ability to use your TV as wireless display device

Using with mobile devices

- There are different standards which enable sharing of screens including graphical, video and audio content between your mobile device and TV.
- Plug the wireless USB dongle to TV first, if the TV doesn't have internal WLAN feature.
- Then press the Source button on the remote and switch to Wireless Display source.
- A screen appears stating that the TV is ready for connection.
- Open the sharing application on your mobile device. These applications are named differently for each brand, refer to the instruction manual of your mobile device for detailed information.
- Scan for devices. After you select your TV and connect, the screen of your device will be displayed on your TV.
- Note: This feature can be used only if the mobile device supports this feature. If you experience problems with the connection check if the operating system version you use supports this feature. There may be incompatibility problems with the operating system versions which are released after the production of this TV. Scanning and connecting processes differ according to the programme you use.

## Connecting Bluetooth Devices (optional)

- Your TV supports Bluetooth wireless connection technology too. A pairing is required before using Bluetooth devices with the TV set. You should do the following to pair your device with the TV: Set the device to pairing mode; Start device discovery on the TV
- Note: Refer to the user manual of the Bluetooth device to learn how to set the device to pairing mode.
- You can connect audio devices or remote controllers to your TV using the Bluetooth wireless technology. Unplug or switch off any other connected audio device in order for wireless connection feature to work correctly. For audio devices you should use the Bluetooth option in the Settings>Sound menu, for remote controllers the Smart Remote option in the Settings>System>More menu. Select the menu option and press the OK button to open the related menu. Using this menu you can discover and connect the devices that use the Bluetooth wireless technology and start to use them. Follow the onscreen instructions. Start the device discovery. A list of available Bluetooth devices will be displayed. Select the device you want to connect from the list and press the OK button to connect. If “Device connected” message is displayed, the connection is successfully established. If the connection fails try it again.

### Image transfer and audio streaming

- You can also use Bluetooth connection to transfer images or stream audio from your mobile device to your TV.
- Pair the mobile device and the TV as described before. Start a device search in your hand-held device. Select your TV from listed devices. Confirm the request for connection on your TV screen and do the same on your hand held device screen. If no pairing is done, image transfer or audio streaming to the TV will not be possible.
- The images sent by mobile device will be displayed on the TV without confirmation request, if the image file is suitable. You can also save the image file to a connected USB memory drive or set as boot logo, if this feature is supported and the file is suitable. Press the Exit button to terminate displaying the image.
- The audio will be routed through the speakers of the TV, after confirmation is given. To start audio streaming unpair the device from your TV if it is paired with your TV previously. After pairing is completed, a confirmation message will be displayed asking whether you want to start audio streaming from your mobile device. Select Yes and press the OK button on the remote of the TV. If the connection is succeeded, all audio will be routed through the speakers of the TV. A symbol will appear on the upper side of the TV screen as long as the audio streaming connection is active. To terminate the audio streaming, you should turn off the Bluetooth connection of your mobile device.
- Close all running applications and all the menus on the TV for a trouble-free transfer. Only image files with sizes smaller than 5 MB and in the following file formats are

suitable; .jpg, .jpeg, .png, bmp. If a file sent by the mobile device does not suit these requirements, it will not be displayed on the TV.

- Note: Wireless devices may operate within the same radio frequency range and may interfere with one another. To improve the performance of your wireless device place it at least 1 meter away from any other wireless devices.

## Connectivity Troubleshooting

### 1. Wireless Network Not Available

- Ensure that any firewalls of your network allow the TV wireless connection.
- Try searching for wireless networks again, using the Network menu screen.

If the wireless network does not function properly, try using the wired network in your home. Refer to the Wired Connectivity section for more information on the process.

If the TV does not function using the wired connection, check the modem (router). If the router does not have a problem, check the internet connection of your modem.

### 2. Connection is Slow

- See the instruction book of your wireless modem to get information on the internal service area, connection speed, signal quality and other settings. You need to have a high speed connection for your modem.

### 3. Disruption during playback or slow reactions

- You could try the following in such a case: Keep at least three meters distance from microwave ovens, mobile telephones, Bluetooth devices or any other WLAN compatible devices. Try changing the active channel on the WLAN router.

### 4. Internet Connection Not Available / Audio Video Sharing Not Working

- If the MAC address (a unique identifier number) of your PC or modem has been permanently registered, it is possible that your TV might not connect to the internet. In such a case, the MAC address is authenticated each time when you connect to the internet. This is a precaution against unauthorized access. Since your TV has its own MAC address, your internet service provider cannot validate the MAC address of your TV. For this reason, your TV cannot connect to the internet. Contact your internet service provider and request information on how to connect a different device, such as your TV, to the internet.
- It is also possible that the connection may not be available due to a firewall problem. If you think this causes your problem, contact your internet service provider. A firewall might be the reason of a connectivity and discovery problem while using the TV in Audio Video Sharing mode or while browsing via Audio Video Sharing feature.

## 5. Invalid Domain

- Ensure that you have already logged on to your PC with an authorized username/ password and also ensure that your domain is active, prior to sharing any files in your media server program on your PC. If the domain is invalid, this might cause problems while browsing files in Audio Video Sharing mode

## Using Audio Video Sharing Network Service

Audio Video Sharing feature uses a standard that eases the viewing process of digital electronics and makes them more convenient to use on a home network. This standard allows you to view and play photos, music and videos stored in the media server connected to your home network.

1. **Server Software Installation:** The Audio Video Sharing feature cannot be used if the server programme is not installed onto your PC or if the required media server software is not installed onto the companion device. Prepare your PC with a proper server programme.
2. **Connect to a Wired or Wireless Network:** See the Wired/Wireless Connectivity chapters for detailed configuration information.
3. **Enable Audio Video Sharing:** Enter the Settings>System>More menu and enable the AVS option.
4. **Play Shared Files via Media Browser:** Highlight the AVS option in the Sources menu by using the directional buttons and press OK. Available media server devices in the network will be listed. Select one and press OK to continue. The media browser will then be displayed.

Refer to the Media Browser menu section for further information on file playback.

If a problem occurs with the network, switch your television off at the wall socket and back on again. Trick mode and jump are not supported with the Audio Video Sharing feature.

PC/HDD/Media Player or any other devices that are compatible should be used with a wired connection for higher playback quality.

Use a LAN connection for quicker file sharing between other devices like computers.

Note: There may be some PC's which may not be able to utilize the Audio Video Sharing feature due to administrator and security settings (such as business PC's).

## Apps

- You can access the applications installed on your TV from Apps menu. Highlight an app and press OK to launch.
- In order to manage the apps installed on your TV, add new apps from the market or to see all available apps in full screen mode highlight the Add More option and press OK. Using this menu option you can add an installed app to Home menu, launch or remove it.

Removed apps will no longer be accessible from Apps menu. You can also add new apps from the market. In order to enter the market highlight the shopping basket logo located on the upper left side of the screen and press OK. Available apps in the market will be displayed. Use directional buttons to highlight an app and press OK. Highlight Add to Apps option and press OK again to add the selected app to Apps menu.

- For quick access to Add More menu you can press the Internet button on the remote, if this button is available.
- Notes: Possible application dependent problems may be caused by the content service provider.
- Third party internet services may change, be discontinued or restricted at any time.

## **Freeview Play Platform**

- Freeview Play platform provides catch-up TV and On Demand services. Simply press the Freeview Play button on your remote control to connect to the Freeview Play platform.
- The Freeview Play platform can also be accessed from the Home and Apps menus. Press Menu button and select Home or Apps. Then highlight Freeview Play and press the OK button.
- You will have to agree to the terms and conditions for Freeview Play services first if you did not agree them during the First Time Installation. Highlight Yes and press OK on the remote to confirm and proceed.
- Integrated TV Player applications will be displayed. Select one and press the OK button. Then select a content that you want to play back and press the OK button to watch.
- Catch-up contents can also be accessed and played back directly from the TV Guide. Refer to the section Electronic Programme Guide for more information.

Requirements: The Freeview Play services may only be used if the following requirements are fulfilled:

- Connecting the TV to the internet. A minimum broadband speed of 2Mbps is required for proper operation of catch up and on demand services.
- Agreeing to the terms and conditions of Freeview Play

Note: Freeview Play platform usage will count towards any monthly broadband data allowance. Only selected channels provide 7-day catch up.

## **Internet Browser**

- To use the internet browser, enter the Apps menu first. Then launch the internet browser application which has an orange coloured logo with earth symbol on it.

- In the initial screen of the browser, the thumbnails of the predefined (if any) links to web sites available will be displayed as Speed Dial options along with the Edit Speed Dial and the Add to Speed Dial options.
- To navigate the web browser, use the directional buttons on the remote or a connected mouse. To see the browser options bar, move the cursor to the top of the page or press the Back/Return button. History, Tabs and Bookmarks options and the browser bar which contains previous/next buttons, the refresh button, the address/search bar, the Speed Dial and the Vewd buttons are available.
- To add a desired website to the Speed Dial list for quick access, move the cursor to the top of the page or press the Back/Return button. The browser bar will appear. Highlight the Speed Dial - button and press the OK button. Then select Add to Speed Dial option and press the OK button. Fill in the blanks for Name and Address, highlight OK and press the OK button to add. Whilst you are on the site you wish to add to the Speed Dial list, highlight the Vewd button and press the OK button. Then highlight Add to Speed Dial option in the submenu and press the OK button again. Name and Address will be filled automatically according to the site you are visiting. Highlight OK and press the OK button to add.
- You can also use the Vewd menu options to manage the browser. Highlight the Vewd button and press the OK button to see available page specific and general options.
- There are various ways to search or visit websites using the web browser.
  - Enter the address of a website(URL) into the search/ address bar and highlight the Submit button on the virtual keyboard and press the OK button to visit the site.
  - Enter keyword/s into the search/address bar and highlight the Submit button on the virtual keyboard and press the OK button to start a search for the related websites.
  - Highlight a Speed Dial thumbnail and press the OK button to visit the related website.
- Your TV is compatible with USB mice. Plug your mouse or wireless mouse adaptor into the USB input of your TV for easier and quicker navigation.
- Some web pages include flash content. These are not supported by the browser.
- Your TV does not support any download processes from the internet via the browser.
- All sites on the internet might not be supported. According to the site; content problems may occur. In some circumstances video contents might not be able to be played.

## **HBBTV System**

- HbbTV (Hybrid Broadcast Broadband TV) is a new industry standard that seamlessly combines TV services delivered via broadcast with services delivered via broadband and

also enables access to Internet only services for consumers using connected TVs and settop boxes. Services delivered through HbbTV include traditional broadcast TV channels, catch-up services, video-on-demand, electronic programme guide, interactive advertising, personalisation, voting, games, social networking and other multimedia applications.

- HbbTV applications are available on channels where they are signalled by the broadcaster (currently various channels on Astra broadcast HbbTV applications). The broadcaster marks one application as “autostart” and this one is started by the platform automatically. The autostart applications are generally launched with a small red button icon to notify the user that there is an HbbTV application on that channel. Press the red button to open the application page. After the page is displayed you can go back to the initial red button icon state by pressing the red button again. You can toggle between the red button icon mode and full UI mode of the application via pressing red button. It should be noted that the red button switching capability is provided by the application and some application may behave differently.
- If you switch to another channel while an HbbTV application is active (either in red button icon mode or full UI mode), the following scenarios can occur.
  - The application can continue running.
  - The application can be terminated.
  - The application can be terminated and another autostart red button application can be launched.
- HbbTV allows the applications to be retrieved both from broadband or broadcast. The broadcaster may enable both ways or one of them. If the platform does not have an operational broadband connection, the platform can still launch applications transmitted on broadcast.
- The autostart red button applications generally provide links to other applications. The user then can switch to other applications by using the links provided. The applications should provide a way to terminate themselves, usually Exit button is used for this.
- HbbTV applications use keys on the remote control to interact with the user. When an HbbTV application is launched, the control of some keys are owned by the application. For example, numeric channel selection may not work on a teletext application where the numbers indicate teletext pages.
- HbbTV requires AV streaming capability for the platform. There are numerous applications providing VOD (video on demand) and catch-up TV services. The user can use play, pause, stop, forward, and rewind keys on the remote control to interact with the AV content.
- Note: You can enable or disable this feature from the More menu in Settings>System menu. Depending on the model of your TV and the selected country option in the First

Time Installation this feature might be available in the Settings>System>Privacy Settings menu instead of the Settings>System>More menu.

## Smart Center

Smart Center is a mobile application running on iOS and Android platforms. With your tablet or phone, you can easily stream your favourite live shows and programmes from your smart TV. Also; you can launch your applications, use your tablet as a remote control for your TV and share media files.

Note: Being able to use all functions of this application depends on the features of your TV.

### Getting Started

- To use Smart Center features, connections have to be done properly. To get connected to your network wirelessly, plug in the WLAN dongle to one of the USB ports if your TV doesn't have internal WLAN feature. To be able to use internet based features, your modem/ router must be connected to the internet.
- IMPORTANT: Make sure the TV and mobile device are connected to the same network.
- For media sharing feature Audio Video Sharing option should be enabled(if available). Press the Menu button on the remote, select Settings>System>More menu and press OK. Highlight AVS and change as Enabled. Your TV is ready to connect to your mobile device now. Install the Smart Center application onto your mobile device.
- Start the Smart Center application. If all connections are configured properly, you will see your TV's name on your mobile device. If your TV's name doesn't appear on the list, wait a while and tap on the Refresh widget. Select your TV from the list.

### Mobile Device screen

- On the main screen you can find tabs to access various features.
- The application retrieves actual channel list from TV first when it starts.
- MY CHANNELS: The programmes of first four channels from the channel list retrieved from the TV are shown. You can change the listed channels. Press on the channel thumbnail and hold. A list of channels will be displayed and you can choose your desired channel to be replaced.
- TV: You can watch content through the TV tab. In this mode you can navigate through the channel list retrieved from your TV and click on thumbnails to view the detail pages.
- RECORDINGS: You can view your active recordings(if available) and reminders through this tab. To delete any item, simply press on the delete icon found on each row.
- EPG(Electronic programme guide): You can view the broadcast schedules of selected channel lists through this tab. You can also navigate through channels by pressing on the selected channel on the EPG grid. Please note that updating / refreshing the EPG information may take a while depending on your network and web service quality.

- Note: Internet connection is required for WEB based EPG information.
- SETTINGS: Configure the application to your liking. You can change;
  - Auto-lock (Only in IOS): The screen of the device automatically turns off after a certain amount of time. Default is off, which means the screen will always stay on.
  - Auto-enable FollowMeTV: FollowMeTV function (if available) will start automatically when this setting is enabled. Default is disabled.
  - Auto-connection to TV: When enabled, your mobile device will automatically connect to last connected TV and skips the TV search screen.
  - Change TV (Only in IOS): Shows the currently connected TV. You can press on this setting to go to the “TV search” screen and change to a different TV.
  - Edit custom channel list: You can edit your custom channel list using this setting.
  - Choose channel list source: You can choose the channel list source to be used in the application. The options are “TV List” and “Custom List”. Additionally you can activate “Remember my choice” option to set the selected channel list source as a constant choice. In this case if the selected source is available it will be used in the application.
  - Version No: Displays the current version of the application.

#### Detail Page

- To open detail page tap on a programme. On the detail page screen you can get detailed information of the programmes you select. There are “Details”, “Cast&Crew” and “Videos” tabs to find on this page.
- DETAILS: This tab provides summary and information about the selected programme. Also there are links to Facebook and twitter pages of the programme selected.
- CAST&CREW: Shows all the people contributed to the current programme. VIDEOS: Provides videos on YouTube related to the selected programme.
- Note: For some functions an internet connection may be required.

#### FollowMe TV Feature (if available)

- Tap on the FOLLOW ME TV widget located at the bottom left of the screen of your mobile device to change the layout for FollowMe TV feature.
- Tap the play icon to start streaming of the content from the TV to your mobile device. Available if your device is in your routers operation range.

Mirror Mode: This mode of FollowMe TV feature is enabled by default and allows streaming the content from any other selected TV sources and Media Browser. Notes:

- Note that only digital(DVB-T/C/S) SD and HD channels are supported.

- Multilanguage audio support and subtitle on/off features are not functional.
- The streaming performance may change depending on the quality of your connection

#### Media Share Page

- To access the Media Share widget tap on the Uparrow on the bottom left side of the screen.
- If the Media Share widget is pressed, a screen is displayed where you can select the media file type to share with your TV.
- Note: Not all image file formats are supported. This function will not work if Audio Video Sharing feature is not supported.

#### Smart Remote Feature

- You can use your mobile device as a remote control for your TV once it has connected to the TV. To use smart remote's full features tap on the Up-arrow on the bottom left side of the screen.

#### Voice Recognition

- 



You can tap on the Microphone(  ) widget and manage your application, giving voice commands such as "Volume Up/Down!", "Programme Up/Down!".

- Note: This feature is only for android based devices available

Keyboard Page: The keyboard page can be opened in two ways; by pressing the Keyboard(



) widget on the application screen or automatically by receiving a command from the

#### TV. Requirements

1. Smart TV
2. Network connection
3. Mobile Device based on Android or iOS platform (Android OS 4.0 or higher; IOS 6 or higher version)
4. Smart Center app.(to be found on online application stores based on Android and iOS platforms)
5. Router modem
6. USB storage device in FAT32 format ((required for USB Recording feature, if available)

Notes:

- For Android devices, Normal(mdpi), Large(hdpi) and Extra Large(xhdpi) screen sizes are supported. Devices with 3" or smaller screen sizes are not supported.
- For iOS devices, all screen sizes are supported.
- User interface of the Smart Center application is subject to change according to version installed on your device

### **Alexa Ready Feature (optional)**

Alexa is Amazon's cloud-based voice service available on many voice controlled assistant devices. Your TV is compatible with and ready to be utilized with Alexa devices. With this feature you can use your voice to control functions on your TV, such as turning on or off, changing channel or input source, controlling volume, and more.

Requirements: The following requirements should be fulfilled:

- Alexa Ready Smart TV
- Amazon Alexa device
- A mobile device, such as your phone or tablet, with Smart Center and Amazon Alexa apps installed on it
- Home network with WLAN capabilities
- Amazon account

How to control your TV with an Amazon Alexa Device

- Connect your TV and mobile device to the same network with internet access as your Alexa device.
- Pair the Smart Center app with your TV. Then tap on the Amazon logo on the main screen of the Smart Center app. You will be directed to a registration page. Follow the on-screen instructions to complete your TV's registration and linking process.
- You will be asked to determine a name for your TV, called 'Friendly Name'(FN). A 'Friendly Name' is a name that reminds you of your TV, such as 'Living Room TV', 'Kitchen TV', 'Dining Room TV', etc. Choose an easy-to-say name. You will say this name to tell Alexa which TV to control.
- Pair the Alexa app on your mobile device with the Alexa device, search for the skill of your TV by the brand name and enable it in the Alexa app. For more information, you can refer to the user manual of the Alexa device.
- Ask Alexa to discover your devices. Say, "discover my devices," or select Discover Devices in the related section of the Alexa app.

Once the discovery process is complete, you will be able to control your TV by voice.

Note: Make sure that the devices are connected to the same network. But once these pairing and linking processes are completed the Alexa device and your TV will no longer have to be on the same network.

After you have performed First Time Installation on your TV, launch the Smart Center application and pair it with your TV again. Then tap on the Amazon logo on the main screen and check if you are logged in to your Amazon account, if not you might need to re-login and determine a Friendly Name again for your TV in order to be able to continue to control your TV with Alexa device

## DVD Mode (optional)

### Notes on Discs

On handling discs

- To keep the disc clean, handle the disc by its edge. Do not touch the surface.
- Do not stick paper or tape on the disc.
- If the disc is contaminated with any substance like glue remove before using it.



- Do not expose the disc to direct sunlight or heat sources such as hot air ducts, or leave it in a car parked in direct sunlight as the temperature can rise quickly and damage the disc.
- After playing, store the disc in its case.

On cleaning

- Before playing, clean the disc with a cleaning cloth. Wipe the disc from the centre out.

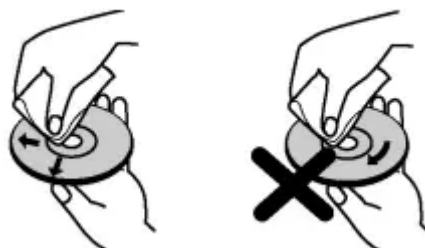

- Do not use solvents such as benzene, thinner, commercially available cleaners or anti-static spray intended for vinyl LPs.

### How to Watch a DVD

- When placing a disc into the loader, labelled side of the disc should be on the front.

- When TV set is turned on, first switch to DVD source by using the Source button on the remote control. Press play on the remote control, or directly press play button on the side panel. If there is no disc inside the loader, place a DVD first and press play.
- Note: If you switch to another source by pressing Source or Programme +/- buttons on the remote control, DVD playback will be paused automatically. You should press Play button and resume the playback manually when you switch to DVD mode.

## DVD Control Panel Buttons



(Play / Pause) Plays/pauses the disc. When DVD menu (root menu) is active, this button functions as “button select” (selects the highlighted item in menu) if this is not prohibited by the disc.



(Stop / Eject) Stop playing disc / Eject or Load the disc.

Note: You cannot eject the disc via the remote control. While playing a file, you should press Stop button three times to eject.

## General Playback

### Basic Play

1. Press the Standby button
2. Insert a disc into the loader. The disc will be automatically loaded and play will commence if the disc does not have any menus recorded on it. A menu may appear on the TV screen after a few moments or the film may start immediately. This behaviour depends on the disc content and may change. Note: Step 3 and 4 are available only when a menu is recorded on the disc.
3. Press Down / Up / Left / Right or the numeric button (s) to select the preferred title.
4. Press OK to confirm the selected item. The played item may be a motion picture, a still picture or another submenu depending on the disc content



For your reference: If an action corresponding to a button is prohibited the “” symbol appears.

### Notes on Playback

1. No sound will be heard during fast forward or rewind.
2. No sound will be heard during slow motion play.
3. Reverse slow motion play may not be available depending on the DVD content.

4. In some cases, the subtitle language is not changed immediately to the selected one.
5. When the preferred language is not selected even after pressing the button several times, it means that the language is not available on the disc.
6. When the player is restarted or the disc is changed, the subtitle selection is automatically changed back to the initial settings.
7. If a language is selected, not supported by the disc, the subtitle language will automatically be set to the disc's priority language.
8. Usually a circulation will happen while switching to another subtitle, that is you can cancel the subtitle by pressing the Text button a number of times until "Subtitles Off" appears on the screen.
9. When the power is turned on or the disc is removed, the language heard is the one selected at the initial settings. If this language is not recorded on the disc, only the available language on the disc will be heard.
10. Some DVDs may not contain root and/or title menus.
11. Reverse stepping is not available.
12. For your convenience: If you attempt to enter a number greater than the total time of the current title, the time search box disappears and  "Input Invalid" message appears on upper-left corner of screen.
13. Slide Show is disabled when the ZOOM mode is on.

## DVD Troubleshooting

### 1. Poor picture quality (DVD)

- Make sure the DVD disc surface is not damaged. (Scratch, fingerprint etc.)
- Clean the DVD disc and try again. See instructions described in "Notes on Discs" to clean your disc properly.
- Ensure that the DVD disc is in the tray with the label facing forward
- A damp DVD disc or condensation may affect the equipment. Wait for 1 to 2 hours in Stand-by to dry the equipment.

### 2. Disc does not play

- No disc in the machine. Place a disc into the loader.
- Disc incorrectly loaded. Note: Ensure that the DVD disc is in the tray with the label facing forward.
- Wrong type of disc. The machine cannot play CDROMS etc. The region code of the DVD must match the player.

### 3. Wrong OSD language

- Select the language in the set-up menu.
- The language for the sound or subtitles on a DVD cannot be changed.
- Multilingual sound and/or subtitles not recorded on the DVD.
- Try to change the sound or subtitles using DVD's title menu. Some DVD's do not allow the user to change these settings without using the disc's menu
- These functions are not available on the DVD.

### 4. No picture

- Make sure you have pressed the correct buttons on the remote control. Try once more.

### 5. No sound

- Check if volume is set to an audible level.
- Make sure the sound isn't turned off by mistake.

### 6. Distorted sound

- Check that the appropriate listening mode setting is correct.

### 7. If nothing works

- If you have tried the above solutions and none seem to work, try switching your TV-DVD off and on again. If this does not work, contact your supplier or TV-DVD repair technician. Never attempt to repair a defective TV-DVD yourself.

#### **Warning**

This content is compiled from multiple sources and is provided for reference purposes only. It may not be complete or fully applicable to all situations. If you are unable to resolve your issue, please contact the product manufacturer or an authorized service provider for official support.