

Cleaner ASSEMBLY

Carton contents

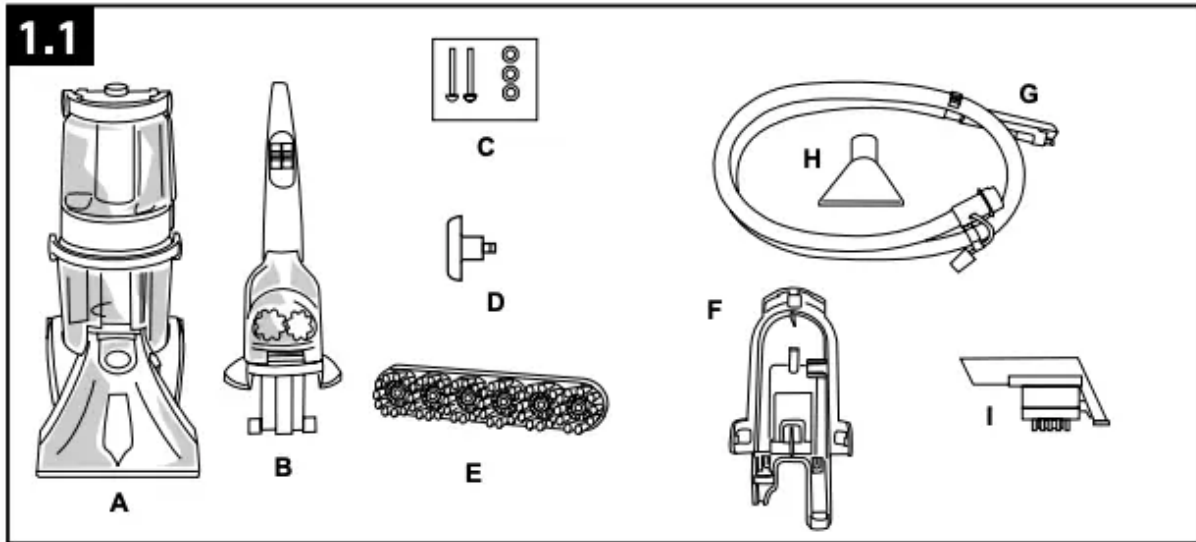

A. Cleaner

B. Upper Handle

C. Handle Bolts and Nuts (Three nuts may be in bag but only two or need for assembly. Bolts and nuts located in bag with hose)

D. Hose/Cord Hook

E. SpinScrub® Brush Assembly

F. Hose/Tool Caddy*

G. Hose

H. Stair/Upholstery Nozzle

I. SpinScrub® Hand Tool*

Remove all parts from carton and identify each item shown. Make sure all parts are located before disposing of packing materials.

*Available on select models only. Accessories not included with your model may be purchased separately by visiting hoover.com

NOTE: Phillips screwdriver needed for assembly.

Attach handle

- 1.2 Remove tank.

- 1.3 Position cord protector.
- 1.4 Slide handle down.
- 1.5 Insert bolts and attach nuts. Tighten with screwdriver.

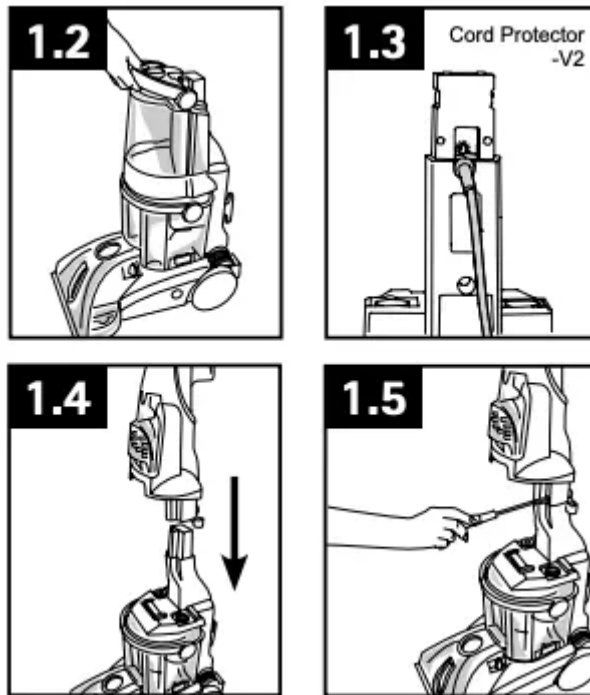

Replace upper tank

- 1.6 Position bottom of tank onto cleaner.
- 1.7 Push top of tank and tank handle while supporting back of cleaner with other hand.
- 1.8 Push up on handle to latch it to cleaner. Check tank to make sure it is secure.



Attach hose/cord hook

- 1.9 Snap hook onto cleaner.

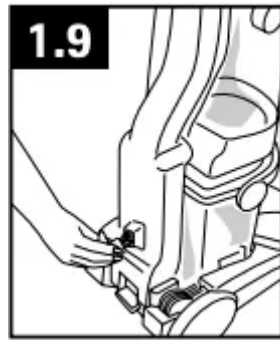

Attach tool caddy (for storage on cleaner)

(Available on select models only)

- 1.10 Insert tabs.
- 1.11 Slide caddy down. Notch (B) rests on hook (C).

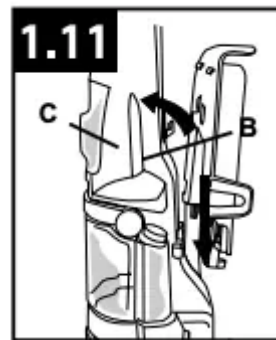

IMPORTANT Tool caddy is removable for storage on wall or in closet.

Store hose

- 1.12 Start.
- 1.13 Wrap.
- 1.14 Finish. Use clips (D) to secure hose and solution tube (E and inset).

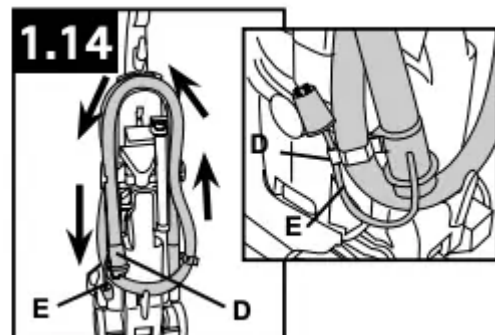
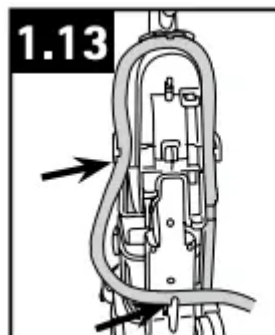
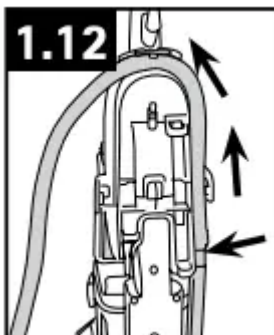

Store tools

- 1.15 Store Tools on back side of cleaner as shown.

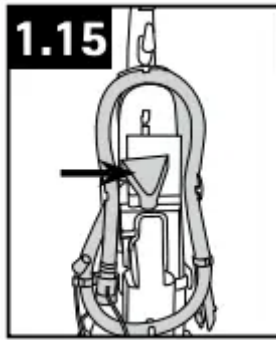

HOW TO USE

Cleaner Description

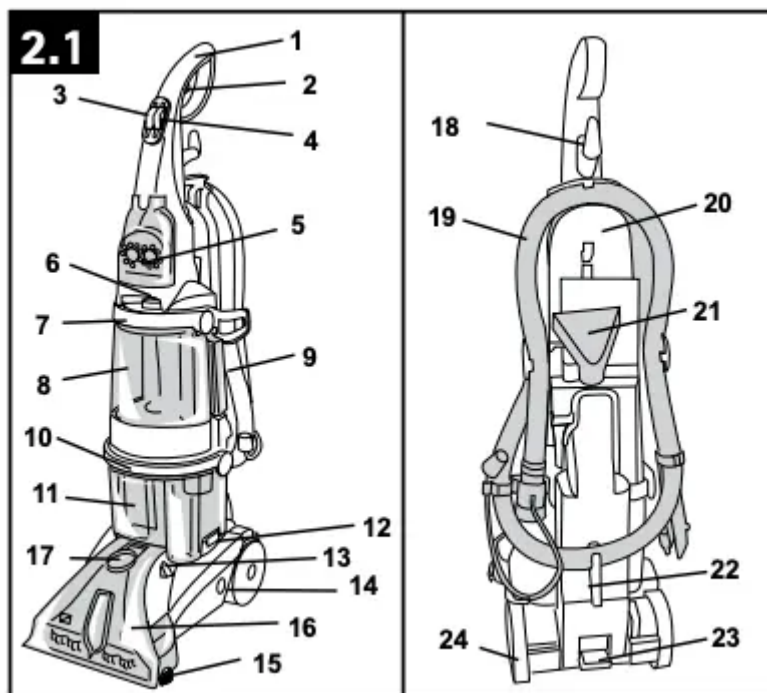

1. Hand Grip

2. Solution Trigger: press to release cleaning solution

3. ON/OFF Switch

4. Rinse Setting Switch

5. SpinScrub® Hand Tool*

6. Carry Handle

7. Clean Water Tank Handle

8. Clean Water Tank

9. Detergent Container

10. Dirty Water Tank Handle

11. Dirty Water Tank

12. Dirty Water Tank Latches

13. SpinScrub® Mode Selector

14. Solution Tube Connection Port

15. Edge Cleaners: provided on both sides of nozzle to remove dirt near baseboards

16. Nozzle

17. Hose Connection Port

18. Cord Hook: rotates for quick cord release

19. Hose*

20. Hose/Tool Caddy*

21. Stair/Upholstery Nozzle*

22. Cord/Hose Hook

23. Handle Release Pedal

24. Wheels

*Accessories not included with your model may be purchased separately by visiting hoover, or your local HOOVER® service center.

Operate cleaner only at voltage specified on data plate on bottom of cleaner. This cleaner is intended for household use

CAUTION ! DO NOT USE THIS EXTRACTOR ON HARD FLOORS UNLESS YOU HAVE THE PROPER HARD FLOOR ATTACHMENT. USING THIS MACHINE ON HARD FLOORS WITHOUT PROPER ATTACHMENT MAY SCRATCH OR DAMAGE YOUR FLOOR.

ON-OFF switch

- To turn cleaner ON, push switch down.
- To turn cleaner OFF, push switch up.

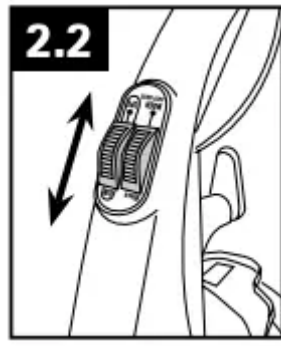

Handle release pedal

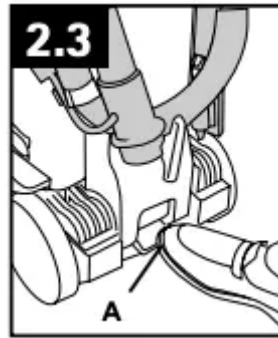

Step on pedal (A) to lower handle to operating position. Handle does not lock into a single position but “floats” to allow convenient operation.

Transporting

To move your cleaner from room to room, put handle in upright and locked position, tilt cleaner back on wheels and push forward.

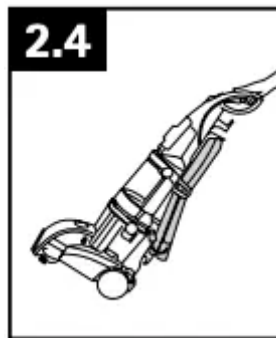

Carry handle

The cleaner may also be lifted by placing a hand above the upper clean water tank handle as shown.

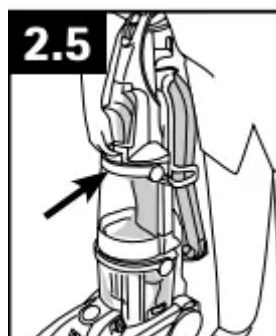

SpinScrub® mode selector

Your SteamVac® cleaner has two agitator brush settings.

SPILL PICK-UP - brushes OFF for picking up spills or cleaning carpets and hard floors when brushing is not desired.

POWER SCRUB - brushes at maximum speed for cleaning carpets

Slide setting selector to the desired setting before cleaning.

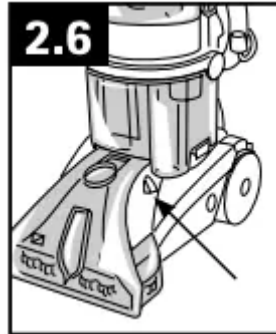

The tanks: Clean Water Solution Tank (upper tank)

- 2.7 The clean water tank (C) holds the water that will either be mixed with detergent for cleaning the carpet or floor, or used to rinse the carpet or floor. The detergent container (D) is permanently attached to the water tank. It holds the detergent that mixes with the water.

How to Fill

Unplug cleaner from electrical outlet. To remove tank, press down on tank handle and pull forward.

- 2.8 Fill tank (E) with hot tap water.

CAUTION ! Do not fill with water above 140°F (60°C).

- 2.9 - 2.10 Fill detergent container (F) with Hoover® Carpet/Upholstery Detergent. Replace container cap and tighten.
- 2.11 Position bottom of tank onto cleaner using one hand on each side of the tank to center it on the unit.

IMPORTANT The tank pivots towards the back of the unit. Push the top of the tank and tank handle while supporting the back of the unit with your other hand.

IMPORTANT Use only HOOVER® SteamVac® detergents. They are specially formulated for use with your SteamVac® cleaner. Non-Hoover® cleaning solutions may harm the machine and void the warranty

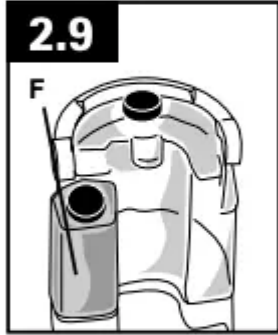
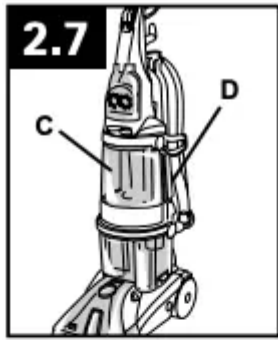

- 2.12 Push up on the handle once the tank is back to latch it to the unit. Check tank to make sure it is securely latched.
- 2.13 There may be a small amount of water (indicated by arrows) on the base when the tank is removed from the unit. This is a normal condition.

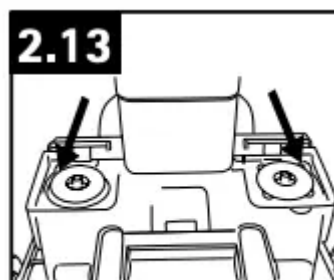

CAUTION ! Detergents contain Anionic and Nonionic Surfactants. Avoid contact with eyes and skin. In case of contact with eyes, flush with cold water for 15 minutes. In case of contact with skin, wash with water. If irritation persists, call a physician.

WARNING

Certain oxygenated-type cleaners, such as OxiClean* and TuffOxi** will damage your SteamVac® detergent container (A), Clean Water Tank (B) or Dirty Water Tank (C).

Use only HOOVER® SteamVac® Oxy detergent for this purpose.

OxiClean is a registered trademark of Orange Glo International, Inc.

TuffOxi is a trademark of Tuff Products for Pets.

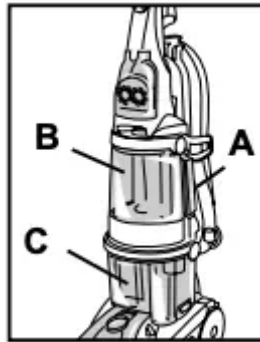

Dirty Water Tank (lower tank)

The Dirty Water Tank holds the dirty solution that is picked up from the surface being cleaned.

When the Dirty Water Tank is full, the automatic shut-off will engage, suction will stop and the tank must be emptied (see Automatic Shut-Off section).

How to Empty

Turn cleaner off and unplug from electrical outlet.

To prevent possible leaking, remove clean water tank by pressing down on tank handle and pulling forward; set tank aside (do not set tank on furniture).

2.14 Turn Dirty Water Tank latches (G) outward (one on each side of tank). Raise handle straight up and lift tank off cleaner. Carry tank to sink or drain.

2.15 Lower handle toward back of tank to unlock lid. Lift lid off tank.

Empty tank and reposition lid.

For full suction, it is important that the Dirty Water Tank lid is properly secured before cleaning.

Raise tank handle to carrying position and place it onto cleaner.

Lower handle to front of tank.

Turn latches (one on each side of tank) inward to lock tank in place.

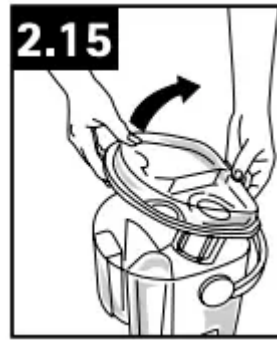
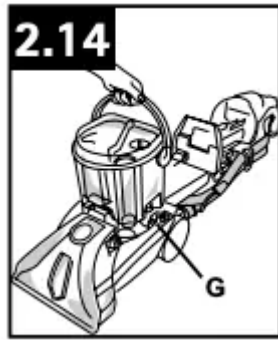

IMPORTANT Make sure the tank handle is moved forward to lock the tank lid before putting cleaner in upright position. Failure to secure properly may result in damage to the tank handle and may cause poor suction.

Automatic shut off

When the Dirty Water Tank (lower tank) is full the automatic shut off mechanism will shut off the cleaner suction (suction will be noticeably reduced).

2.16 At that time, the yellow float disk will rise to the top of the Dirty Water Tank lid (B). The cleaner will no longer pick up dirty solution and the motor sound will become noticeably higher in pitch.

When this happens, turn cleaner off and empty Dirty Water Tank before continuing use.

Check clean water tank also; it may need to be refilled.

Do not use without float and float retainer in place. If broken or dislodged, take to an Authorized Dealer for repair.

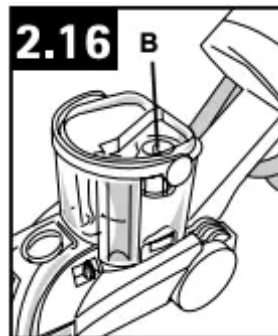

How to CLEAN

Before you begin cleaning

- a. Vacuum thoroughly - For carpet, use a HOOVER® vacuum cleaner with an agitator for best results. Vacuum upholstery with a vacuum cleaner with cleaning tool attachments. Use a crevice tool to reach into tufts and folds. Do not use the carpet cleaner as a dry vacuum cleaner.

- b. For upholstery, check cleaning code - Use your HOOVER® carpet cleaner only if the upholstery fabric is marked with a “W” (for “wet” clean) or “S/W” for “solvent/dry” or “wet” clean). Do not clean fabric marked “S” (“solvent/dry” clean only). If your upholstery does not have a code, seek professional assistance.
- c. Test for colorfastness - Wet a white absorbent cloth with the detergent. In a small, hidden area, gently rub the surface with the dampened cloth. Wait ten minutes and check for color removal or bleed with white paper towel or cloth. If surface has more than one color, check all colors.
- d. When cleaning entire floor, move furniture out of area to be cleaned (may not be necessary if only high traffic areas are to be cleaned). For furniture too heavy to move, place aluminum foil or wax paper under legs. This will prevent wood finishes from staining carpet. Pin up furniture skirts and draperies.
- e. Pretreat spots and heavy traffic areas with HOOVER® Spot & Stain Spray Cleaner*- Follow Directions on bottle.
- f. To prevent staining, use plastic or aluminum foil to protect wood or metal surfaces from possible water spray.
- g. To avoid wetting and possible damage to wood floors underneath area rugs/carpet, either move area rugs/ carpet to a non-wood hard floor surface or place waterproof material (e.g. plastic) underneath them before cleaning.

* Available at additional cost if not included with your model.

Cleaning Carpet

Read “Before You Begin Cleaning” instructions above.

Fill Clean Water Tank according to instructions for Figs. 2.9.

Fill detergent container with Hoover® detergent according to instructions for Figs. 2.10 and 2.11.

Select proper SpinScrub® mode (see pg. 8).

Dry hands and plug cord into a properly grounded outlet.

Do not clean over floor electrical outlets.

To avoid walking on damp carpet, start at the end of the room farthest from the door or path to sink where tanks will be emptied and filled.

Step on handle release pedal and lower handle to operating position.

- 3.1 Set Rinse Setting switch to Wash/Rinse. Turn cleaner ON.
- 3.2 Squeeze trigger to apply cleaning solution and slowly push cleaner forward (equals one wet stroke).
- Continue to squeeze trigger and slowly pull cleaner back toward you (second wet stroke).

FOR MODELS WITH AUTO RINSE FEATURE (available on select models only)

- 3.1a Set Rinse Setting switch to Wash/Auto Rinse. Turn cleaner ON.
- 3.2a Squeeze trigger to apply cleaning solution and slowly push cleaner forward (equals one wet stroke).

Continue to squeeze trigger and slowly pull cleaner back toward you (second wet stroke). The cleaner rinses the carpet on the backward pass.

IMPORTANT To assure proper rinsing, it is important to keep the cleaner on the same path backward as forward.

Release trigger and slowly push cleaner forward over area just sprayed with solution (dry stroke). Then slowly pull cleaner back toward you without squeezing trigger (dry stroke). Continue using dry strokes until little water is visible passing through the Dirty Water Tank lid (Pass over the same area a minimum of 4 times = 2 while squeezing the trigger and 2 without).

For best results, use straight, parallel strokes. Overlap strokes by 1 inch to help prevent streaking.

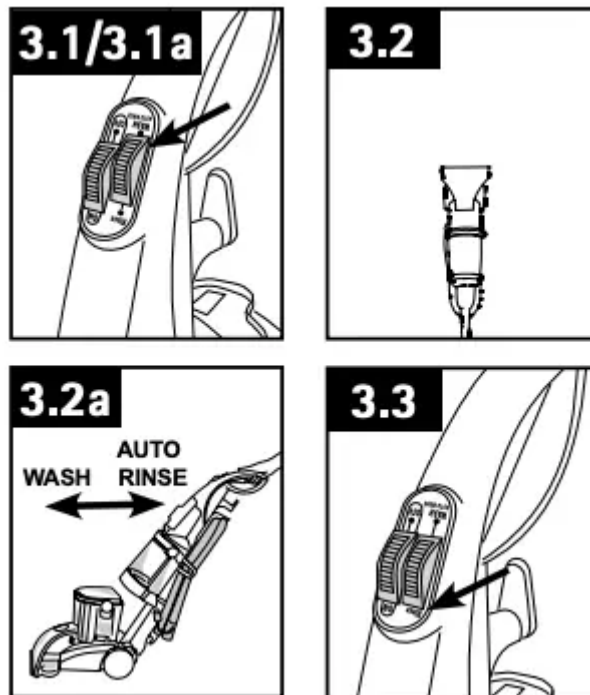

Keep nozzle flat on floor for both forward and reverse strokes.

- 3.3 If you would like to rinse the carpet with water only, set Rinse Setting switch to RINSE. Repeat cleaning motion. In this setting, rinsing will be done on both forward and reverse strokes.

For heavily soiled areas, repeat cleaning motion. Avoid saturating carpet, as noted.

It is best to alternate wet and dry strokes as described above.

For best cleaning results and to aid in faster drying of carpet, end with more dry strokes. (Continue using dry strokes until little water is visible passing through the Dirty Water Tank lid.)

Empty Dirty Water Tank when the motor sound becomes higher pitched and there is a loss in suction (see “Automatic shut-off”, Fig. 2.17).

When finished cleaning, follow “After Cleaning” instructions on page 13.

IMPORTANT To avoid saturating carpet, do not use more than 4 wet strokes over one area. Always end with dry strokes.

Picking up spills

Your HOOVER® SteamVac® cleaner may also be used to pick up small liquid spills on carpet or upholstery.

For best results, pick up spills immediately by placing the stair/upholstery nozzle just above the spill and suction up any residue on top of the carpet. If the spill remains, place either the stair/upholstery nozzle or floor nozzle with the SpinScrub® mode selector to SPILL PICK-UP in front of the spill, pull the nozzle very slowly over the spill initially with suction only. Repeat with spray and suction.

If a spot is left, the stair/upholstery nozzle is generally more effective for removing it. Although no cleaning solution can completely remove all spots, they can be treated by following the instructions provided by the manufacturer of the carpet, upholstery, or hard floor surface being cleaned.

Do not use the SteamVac® cleaner to pick up flammable or combustible liquids or chemicals.

When finished, follow “After Cleaning” instructions.

After cleaning

Allow carpet or upholstery to dry. To help prevent matting and resoiling the carpet, keep children and pets away from surface until it is completely dry. If it is necessary to walk on damp carpet, place towels or white cloths on the traffic areas.

If furniture must be replaced before the carpet is dry, place plastic or aluminum foil under legs of furniture so metal slides or wood finishes will not stain the carpet.

Empty tanks, rinse with clean water and let air dry. Rinse the Dirty Water Tank lid and let air dry.

- 3.4 Remove lint from filter screen located inside Dirty Water Tank.
- 3.5 Remove lint from filter screen located on bottom of cleaner.

IMPORTANT When brushes seem to be rotating slowly, disconnect cleaner from electrical outlet and check and clean this screen.

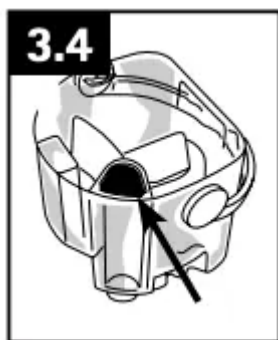

TOOLS

Attach hose

CAUTION ! To reduce the risk of injury from moving parts, unplug cleaner.

How to Attach

- 4.1 Open hose connection port (A).

Insert short hose end, matching tabs on hose with same-sized slots in connection port.

Push hose into port and lock in place.

- 4.2 Plug solution tube firmly into solution connection port (B).

How to Remove

4.2 Squeeze latches (C) on top and bottom of hose. Remove hose from port. Close door. Remove solution tube from solution connection port.

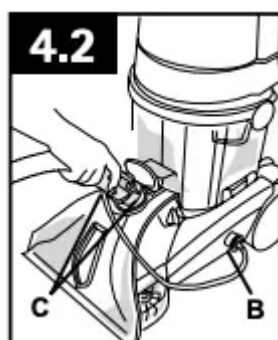
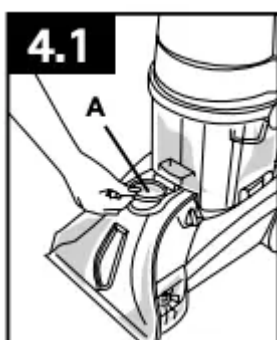

Tools

- A. SpinScrub® Hand Tool (Available on select models only) has rotating brushes for extra scrubbing action on small carpet areas, carpeted stairs and upholstery. For some models, the brushes can be removed for converting to the scrub module. (Available on select models only)
- B. Stair/Upholstery Nozzle has a built-in brush to help provide the scrubbing action some spots may need for removal.

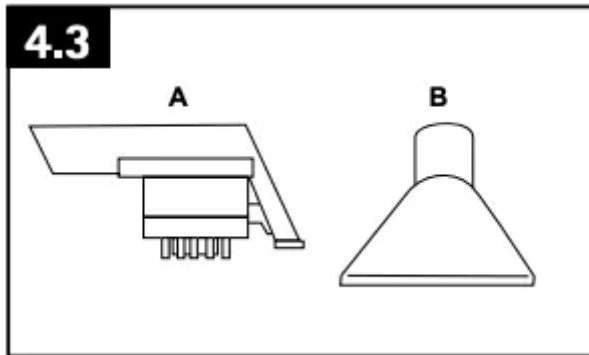

SpinScrub® hand tool

(Available on select models only)

- 4.4 To remove the SpinScrub® hand tool pull tool down and outward.

To reposition the tool, reverse this procedure

How to Reattach Tool Cover

- 4.5 The tool cover is designed with a break-away feature which allows it to snap free if it is pushed open too far.

To reattach, align hinges of cover with holes on sides of tool storage area. Snap door into place.

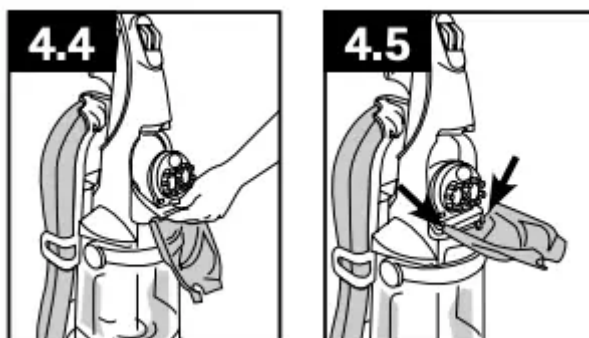

How to Attach Tools

CAUTION ! To reduce the risk of injury from moving parts, unplug cleaner.

Place handle in upright position and remove hose from rack.

All tools attach to the hose in the same manner:

- 4.6 Connect tool to hose by sliding it onto connector until the tab (G) locks it securely.

Using your thumb, push forward and up on the latch (H) to remove tool.

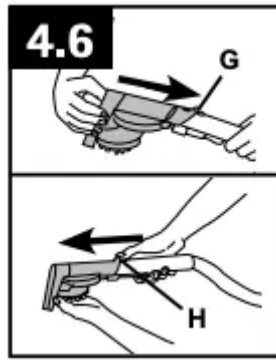

After Using Tool

Drain suction hose by turning cleaner ON and holding nozzle up for several minutes. Do not press trigger.

CAUTION ! To reduce the risk of injury from moving parts, unplug cleaner.

Disconnect hose and solution tube from cleaner.

- 4.7 Drain solution tube by placing round end in sink and raising nozzle above your head. Press the trigger.
- 4.8 The tool caddy can be removed and hung on a coat hanger for storage or placed back on the cleaner.

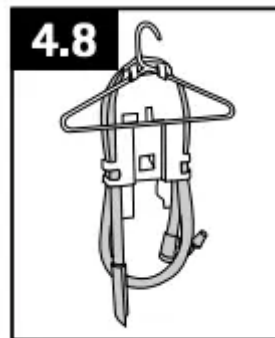
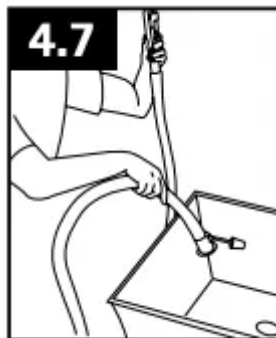

Cleaning carpeted stairs

Read “Before You Begin Cleaning” instructions on page 10.

Attach hose and solution tube as instructed in Figs. and 4.2.

Place handle in upright position. Agitator brushes will not rotate while handle is in upright position.

Fill clean water tank according to instructions for Figs. 2.9 to 2.11.

Fill detergent container with HOOVER® detergent according to instructions for Fig. 2.11.

Attach tool to end of hose.

Hose length may require that machine be placed at the top of the stairs to clean upper half of stairway and at bottom of stairs to clean lower half.

WARNING !

- To prevent machine from falling, use extra caution when cleaning on stairs.
- Do not place cleaner on stairs.
- Do not point tools toward people or pets.

Dry hands and plug cleaner into a properly grounded outlet.

Set Rinse Setting switch to WASH. Turn cleaner ON.

- 4.9 Pre-spray the carpeted stair by holding the tool (A) or (B) about one inch above the carpet and push it forward while pressing the trigger (equals one wet stroke).

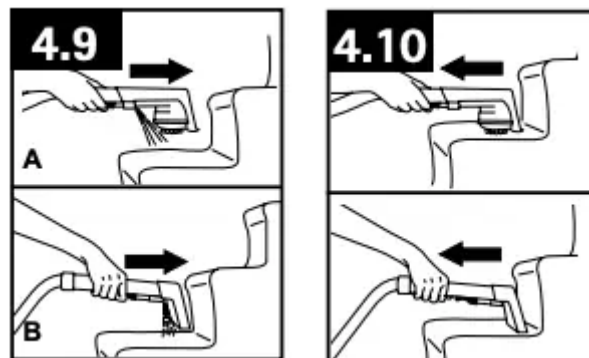

Position tool against the riser and slightly press it into carpet pile. Press the trigger and pull the tool slowly over the carpet (second wet stroke). Release trigger at end of stroke.

- 4.10 Lift tool, and position it against riser. Pull tool slowly over carpet without pressing trigger (dry stroke).

Overlap strokes by 1/2 inch to help prevent streaking.

It is best to alternate wet and dry strokes as described above. End with more dry strokes to aid in faster drying of carpet.

To avoid saturating carpet, do not use more than wet strokes over any one area. Always end with dry strokes.

If additional cleaning is necessary, wait until the carpet is completely dry before using the tool again.

Empty Dirty Water Tank when the motor sound becomes higher pitched and there is a loss in suction see “Automatic Shut-Off”, Fig. 2.17).

When finished cleaning, follow “After Cleaning” instructions on page 12 and “After Using Tool” instructions on page 14.

Cleaning upholstery

Read “Before You Begin Cleaning” instructions on page 10.

Be sure to check the cleaning code on your upholstery. Use your cleaner only on upholstery marked "W" or "W/S".

Attach hose and solution tube as instructed in Figs. to 4.2.

Place handle in upright position. Agitator brushes will not rotate while handle is in upright position.

Fill Clean Water Tank according to instructions for Figs. 2.9 to 2.11.

Fill detergent container with HOOVER® detergent according to instructions for Fig. 2.10. Do not use hard floor cleaning solution when cleaning upholstery.

Attach tool to end of hose.

Do not point tools toward people or pets.

Dry hands and plug cleaner into a properly grounded outlet.

IMPORTANT rinse is not available during tool use. The hose will only dispense water mixed with detergent.

Set Rinse Setting switch to WASH. Turn cleaner ON.

- 4.11 Gently press the tool onto the fabric. Press the trigger and slowly pull the nozzle over the fabric.

Overlap strokes by 1/2 inch to help prevent streaking.

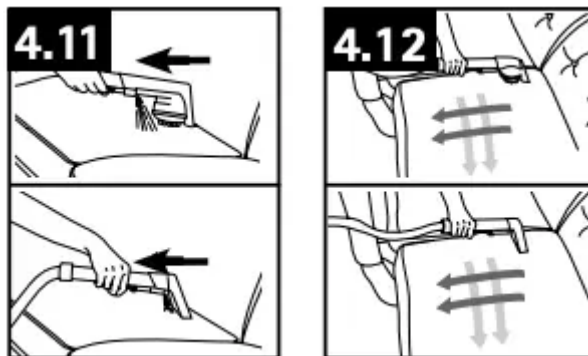

Make additional strokes without pressing the trigger to remove more moisture.

To clean in corners or creases, lift the tool one half inch from the fabric and press the solution trigger.

Vacuum up the solution with the tool without pressing the trigger

- 4.12 For heavily soiled areas, it may be necessary to repeat the cleaning process. Make crisscrossing strokes to the original pattern; overlap each pass.

Make no more than 2 passes with the solution over any one area to prevent over-wetting and damage to fabric.

If additional cleaning is necessary, wait until the upholstery is completely dry before using the tool again.

Empty Dirty Water Tank when the motor sound becomes higher pitched and there is a loss in suction (see “Automatic Shut-Off”, Fig. 2.17).

When finished cleaning, follow “After Cleaning” instructions on page 12 and “After Using Tool” instructions on page 14.

MAINTENANCE

Familiarize yourself with these home maintenance tasks as proper use and care of your cleaner will ensure continued cleaning effectiveness. Any other servicing should be done by an authorized service representative.

Nozzle: How to Clean

If lint or other debris becomes lodged in nozzle, it can be removed for cleaning.

CAUTION ! To reduce the risk of injury from moving parts, unplug cleaner before servicing.

Remove both tanks as described in Fig. 2.16. With handle in upright position, tilt cleaner back so that handle rests on the floor.

- 5.1 Lift up rear edge of nozzle. Slide nozzle up and remove from cleaner.
- 5.2 To replace nozzle, line up tabs (A) on nozzle with holes (B) in cleaner. Slide tabs into holes.

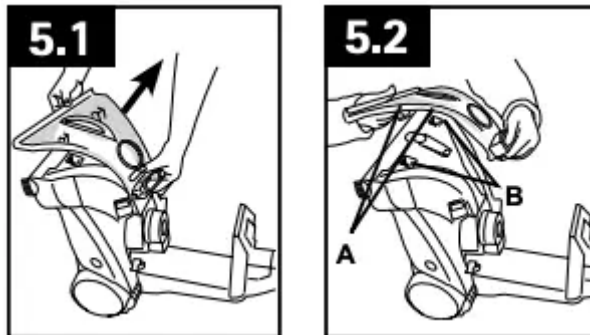

Slide nozzle completely onto cleaner. Press down on nozzle to secure it.

Replace Dirty Water Tank (Fig. 2.16).

The nozzle must be in the proper position in order for the Dirty Water Tank to go on properly

Brushes: How to Change and Clean

Your cleaner is equipped with removable brushes. Follow these directions for changing brush assemblies or for easy cleaning.

CAUTION ! To reduce the risk of injury from moving parts, unplug cleaner before servicing.

How to Remove

To prevent possible leaking, remove Clean Water Tank and Dirty Water Tank. Set tanks aside.

With handle in upright position, tilt cleaner back until handle rests on the floor.

- 5.3 Grab brush assembly and pull firmly. The brushes can be cleaned under running water.

How to Replace

- 5.4 Align posts (A) on both ends of brush assembly with slots (B) in cleaner housing.

Make sure that the square post (C) also aligns with the square hole (D). Turn brushes slightly until post fits easily into hole.

Press brush assembly firmly to snap into place.

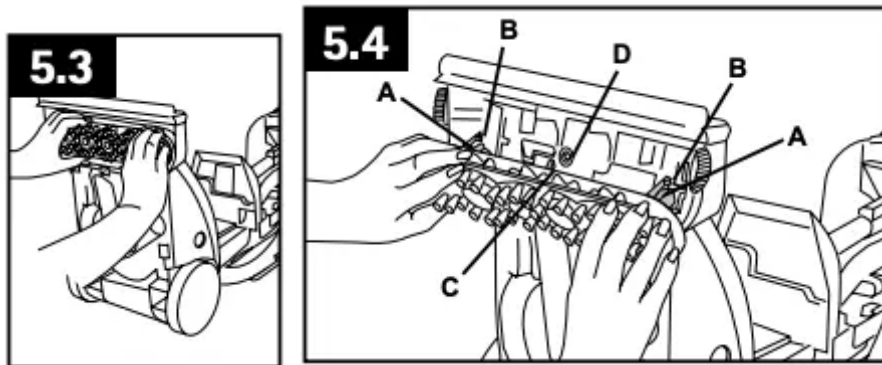

Valve: How to Unclog

Remove Clean Water Tank.

- 5.5-5.6 Turn valve cap (A) counter clockwise and remove.

Soak valve cap in warm water for at least 15 minutes. Wipe cap dry

- 5.7 Align slots (B) on cap with tabs (C) in opening.

Turn cap clockwise to tighten.

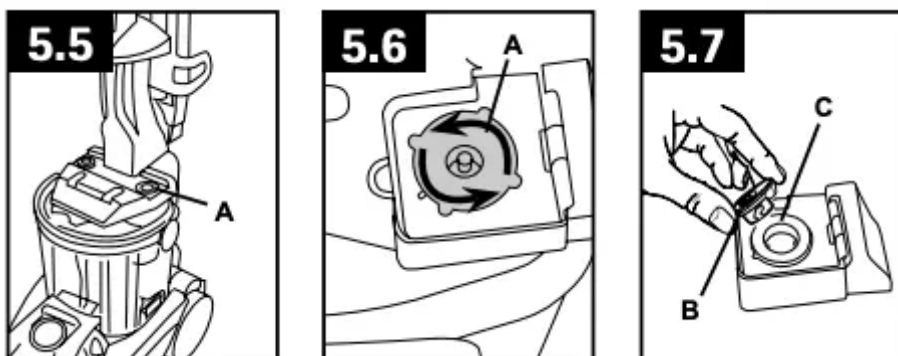

Storage

Before storing:

- Empty Clean Water Tank and let air dry. Replace on cleaner.
- Empty Dirty Water Tank, rinse tank and lid thoroughly with clean water and let air dry.

Allow brushes and underside of carpet cleaner to air dry thoroughly before storing carpet cleaner on a carpeted or wood surface.

Lubrication

The motor is equipped with bearings that contain sufficient lubrication for the life of the motor.

The addition of lubricant could cause damage. Therefore, do not add lubricant to motor bearings.

TROUBLESHOOTING

If a minor problem occurs, it usually can be solved quite easily when the cause is found by using the checklist below. Any other servicing should be done by an authorized service representative.

WARNING ! To reduce risk of personal injury - unplug cleaner before servicing.

Cleaner won't run.

- Not firmly plugged in.
 - Plug unit in firmly.
- No voltage in wall plug.
 - Check fuse or breaker in home.
- Blown fuse or tripped breaker.
 - Replace fuse or reset breaker in home.

Low suction.

- Dirty Water Tank full/ automatic shut off engaged.
 - Remove and empty Dirty Water Tank. Clean filter screen.
- Blockage In tool on end of hose.
 - Remove tool and clear blockage.
- Dirty Water Tank lid not on correctly.
 - Make sure lid is on securely.
- Clean Water Tank empty, but detergent remains.
 - Fill Clean Water Tank

Clean water won't dispense.

- Clean Water Tank not firmly in place.
 - Make sure tank is securely locked in position.
- Clean Water Tank or detergent container empty.
 - Refill container according to instructions for surface being cleaned.
- Dirty Water Tank lid not on correctly.
 - Make sure lid is firmly in place.

Detergent won't dispense

- Valve cap clogged.
 - Remove and clean valve cap see instructions below).

Brushes/brush indicator won't rotate during floor cleaning.

- Dirty filter screen on bottom of unit.
 - Clean screen.

Helpful Reminders



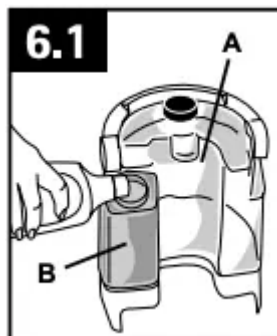

CAUTION ! Unplug the cleaner before doing any of the following.

- Use HOOVER® brand detergents; others may foam too much or cause leaking.
- Use extra dry strokes to aid in faster drying of the carpet.
- 6.1 Fill tank (A) with hot (under 140°F /60°C) tap water ONLY. Do not put any detergent in water tank. Fill detergent container (B) with HOOVER® detergent.
- 6.2 Secure Dirty Water Tank lid before cleaning.
- Empty Dirty Water Tank when full or when automatic shut-off engages.



CLEANING PRODUCTS

WARNING: To reduce the risk of fire and electric shock due to internal component damage, use only Hoover® cleaning products and Hoover® hard surface attachments intended for use with the appliance as noted below.

Hoover® Cleaning Product Guide							
Product Name	 Deep Cleansing	 Premium Pet	 Oxy	 Anti-Allergen ¹	 Hard Floor	Hoover Platinum Collection® Professional Strength	Hoover Platinum Collection® Pet Plus
Hoover® Quick & Light™	✓	✓	✓	✓		✓	✓
Hoover® SteamVac®	✓	✓	✓	✓	✓ ²	✓	✓
Hoover® MaxExtract™ Dual V®	✓	✓	✓	✓	✓ ³	✓	✓
Hoover® MaxExtract™ Dual V® All Terrain	✓	✓	✓	✓	✓	✓	✓
Hoover Platinum Collection®	✓	✓	✓	✓		✓	✓
Hoover® FloorMate®					✓		

¹ Allergens: pollen, pet dander, dirt, and dust.

² When cleaning a hard surface, the Hoover® hard surface attachment below must be used (optional if not included):
5 Brush Hoover® part # 48417008.

³ When cleaning a hard surface, the optional Hoover® hard surface attachment below must be used:
6 Brush Hoover® part # 36419008
5 Brush Hoover® part # 48417007.

For optimal performance use Hoover® brand detergents, wipes, and spot cleaners available at Hoover.com and retailers nationwide.



Warning

This content is compiled from multiple sources and is provided for reference purposes only. It may not be complete or fully applicable to all situations. If you are unable to resolve your issue, please contact the product manufacturer or an authorized service provider for official support.