

## CONTROL PANEL AND FEATURES

Not all features and cycles are available on all models.

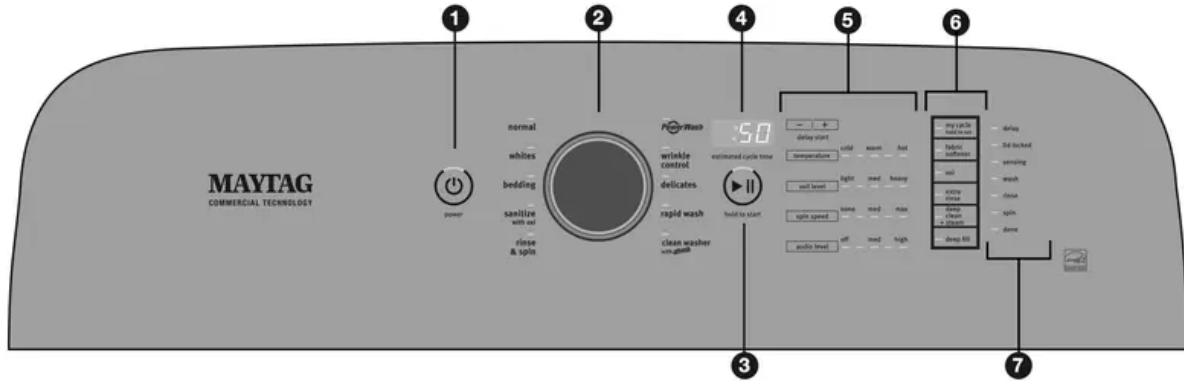

**NOTE:** The control panel features a sensitive surface that responds to a light touch of your finger. To ensure your selections are registered, touch the control panel with your finger tip, not your fingernail. When selecting a setting or option, simply touch its name until the desired section is illuminated.

### 1. POWER BUTTON

Touch to turn the washer On. Touching once while the washer is on will cancel the current cycle and turn the washer Off.

### 2. WASH CYCLE KNOB

Use the Wash Cycle knob to select cycles on your washer. See the “Cycle Guide” for detailed descriptions of cycles.

### 3. START/PAUSE BUTTON

Touch and hold the START/PAUSE button to begin the selected cycle; touch again to pause a cycle.

### 4. ESTIMATED CYCLE TIME

The Estimated Cycle Time display shows the time required for the cycle to complete. Factors such as load size and water pressure may affect the time shown in the display. Tightly packed loads, unbalanced loads, or excessive suds may cause the washer to adjust the cycle time, as well.

If you have set a delay start to the cycle, the Estimated Cycle Time display will show the delay time adjusted.

When the cycle is complete, the display will show END until the lid is opened.

### 5. CYCLE MODIFIERS

When you select a cycle, its default settings or the previous cycle selection used will light up.

#### DELAY START

Touch DELAY START to delay the start of the wash cycle up to 12 hours (“12h”). Touch DELAY START until “0h” appears in the status display to turn off, or touch POWER.

### **TEMPERATURE**

Temperature control senses and maintains uniform water temperatures by regulating incoming hot and cold water.

Select a wash temperature based on the type of fabric and soils being washed. For best results and following the garment label instructions, use the warmest wash water that is safe for your fabric.

On some cycles, warm and hot water may be cooler than your previous washer.

Even for cold wash settings, some warm water may be added to the washer to maintain a minimum temperature.

### **SOIL LEVEL**

Soil Level (wash time) is preset for each wash cycle.

As you touch the Soil Level pad, the cycle time (minutes) will increase or decrease in the Estimated Time Remaining display and a different wash time will appear.

Select the most suitable setting for your load. For heavily soiled items, select Heavy for more wash time. For lightly soiled items, select Light for less wash time. A lighter soil level setting will help reduce tangling and wrinkling.

### **SPIN SPEED**

This washer automatically selects the spin speed based on the cycle selected. The preset speeds can be changed. Not all spin speeds are available with all cycles.

Faster spin speeds mean shorter dry times, but may increase wrinkling in your load.

Slower spin speeds mean less wrinkling, but will leave your load more damp.

### **AUDIO LEVEL**

Use this to turn the button sounds and/or signal indicating the end of a wash cycle to medium, high, or off.

**NOTE:** You may also turn off the tones that sound when a feature, setting, or option is touched.

## **6. OPTIONS**

You may add or remove options for each cycle. Not all options can be used with all cycles, and some are preset to work with certain cycles.

### **MY CYCLE**

If you have a cycle with custom settings that you use frequently, you can use the My Cycle feature to keep your preferred settings ready to use. To save the cycle, touch and hold MY CYCLE (approximately 3 seconds) until a beep sounds and the My Cycle LED is lit. Once a configuration has been saved, you may power on the washer and briefly touch MY CYCLE to load your saved cycle and settings.

### **FABRIC SOFTENER**

Select the Fabric Softener option so that the desired product is added to the load at the correct time.

## **OXI**

Select the Oxi option so that the desired product is added to the load at the correct time.

## **EXTRA RINSE**

This option can be used to automatically add a second rinse to most cycles.

## **DEEP CLEAN + STEAM**

The Deep Clean + Steam option adds additional soak and wash time to many cycles to help remove tough stains, as well as a steam boost for added cleaning power. Deep Clean + Steam uses a heater within the washer to maintain the selected temperature setting throughout the wash period. Deep Clean + Steam may be selected as an option with other cycles.

**NOTE:** The Deep Clean + Steam option may increase the selected temperature.

## **DEEP FILL**

If you would like to add the maximum amount of water to your wash cycle, select the Deep Fill option.

### **NOTES:**

Expect longer cycle times due to extended fill times when using the Deep Fill option.

Deep Fill is not available in the Normal cycle mode.

## **7. CYCLE STATUS LIGHTS**

The Cycle Status Lights show the progress of a cycle. At each stage of the process, you may notice sounds or pauses that are different from traditional washers.

### **DELAY**

When Delay Start has been selected, the Delay light will illuminate and remain illuminated until the cycle begins.

### **LID LOCKED**

To allow for proper load sensing and spinning, the lid will lock and the Lid Locked light will turn on. This light indicates that the lid is locked and cannot be opened.

If you need to open the lid, touch START/PAUSE. The lid will unlock once the washer movement has stopped. This may take several minutes if the load was spinning at a high speed. Touch and hold the START/PAUSE button again for up to 3 seconds to restart the cycle.

Avoid opening the lid during sensing. The sensing process will start over when the washer is restarted.

### **SENSING**

When the Start/Pause button is touched and held, the washer will first perform a self-test on the lid lock mechanism. You will hear a click, the basket will make a slight turn, and the lid will unlock briefly before locking again.

Once the lid has locked the second time, the washer will use short, slow spins to estimate the load size. These sensing spins may take 2 to 3 minutes before water is added to the load and you may hear the hum of these spins. If the sensing light is on, then the washer is working properly. You will hear the motor turn the basket in short

pulses to thoroughly wet the load. The washer will then move the load briefly, pause to allow water to soak into the load, and resume adding water.

This process may repeat until the correct amount of water has been added for the load. You may also hear water flowing through the dispenser, adding detergent to the load.

**NOTE:** Avoid opening the lid during sensing. The sensing process will start over when the washer is restarted. The sensing light may also come on during the Wash portion of the cycle. This is normal.

#### **WASH**

You will hear the motor and agitator moving the load. Unlike traditional washers, the load is not covered with water. Rather than diluting detergent as done in an agitator-style washer, this washer delivers the detergent directly to the soils. The motor sounds may change at different stages in the cycle. The wash time is determined by the selected Soil Level.

#### **RINSE**

You will hear sounds similar to the wash cycle as the washer rinses and moves the load.

#### **SPIN**

The washer spins the load at increasing speeds for proper water removal based on the selected cycle and spin speed.

#### **DONE**

Once the cycle is complete, this light will come on. Remove the load promptly for best results.

## Dispensers



### A. Detergent dispenser

Pour measured amount of liquid HE detergent into the detergent dispenser. The detergent will dispense at the optimum time during the wash cycle.

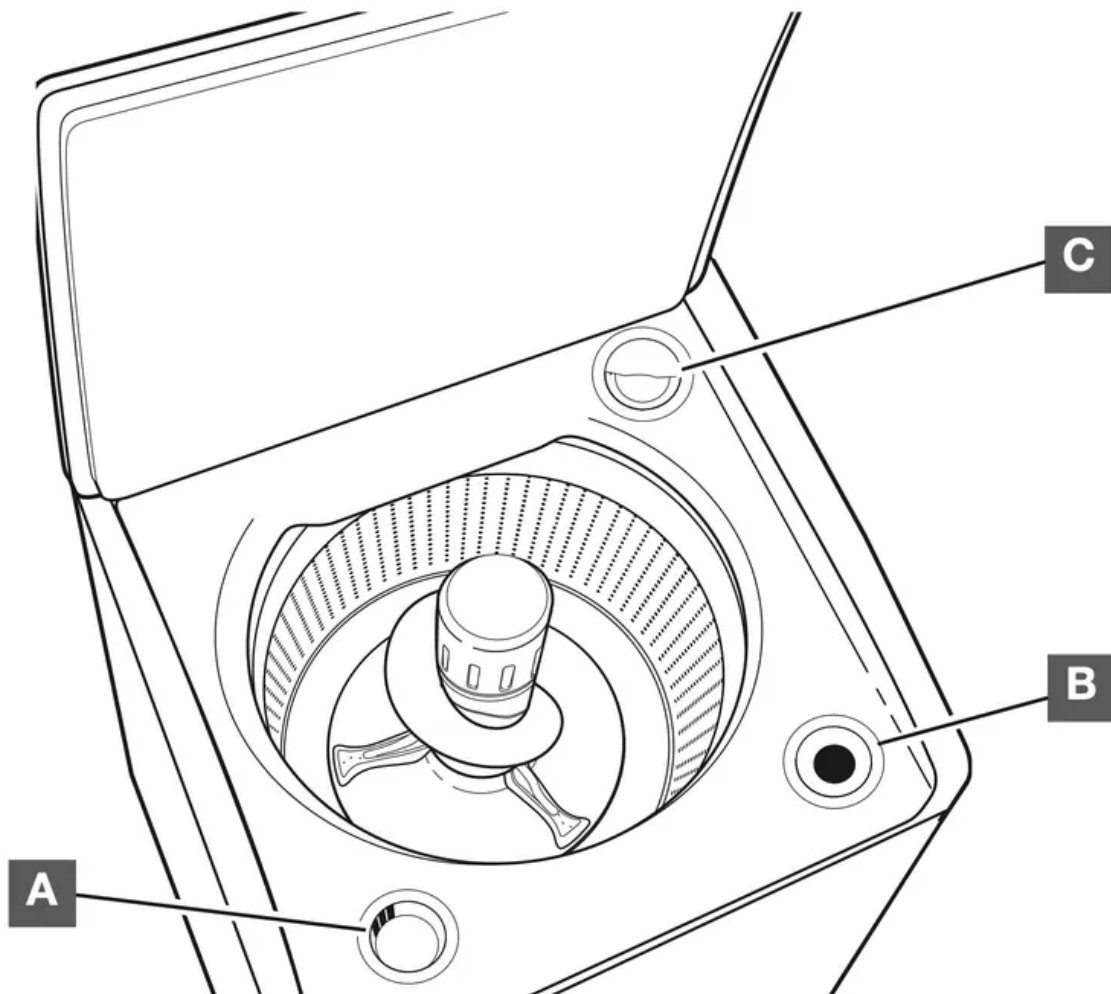

Use only High Efficiency (HE) liquid detergent.

**NOTE:** Do not place single-dose laundry packets or powder detergent into the dispenser. Add single-dose laundry packets or powder detergent directly to the washer basket.

### **B. Liquid fabric softener dispenser**

Pour measured liquid fabric softener into the liquid fabric softener dispenser, if desired. It will dispense automatically at the optimum time.

- Use only liquid fabric softener in this dispenser.

### **C. Liquid chlorine bleach and Oxi dispenser**

The bleach will be automatically diluted and dispensed at the optimum time during the wash cycle. This dispenser cannot dilute powdered bleach.

**NOTE:** If a gel bleach is used, the Oxi button must be touched to assist in dispensing the gel.

This dispenser holds up to 3/4 cup (180 mL) Oxi booster or other laundry booster, such as powdered or liquid color-safe bleach. Laundry boosters are automatically dispensed at the proper time during the wash cycle.

Be sure to select Oxi from the options to ensure proper dispensing.

**NOTE:** Fill dispenser with only Oxi. Do not mix with bleach.







**IMPORTANT:** Even on cold cycles, using the Oxi booster option will cause the washer to use some warm water to assist in dispensing the Oxi liquid/powder.

## CYCLE GUIDE

For best fabric care, choose the cycle that best fits the load being washed. Recommended settings for best performance are shown in Bold. Not all settings and options are available on each cycle.

Items to wash:	Cycle:	Wash Temp:	Spin Speed:	Cycle Details:
Cottons, linens, and mixed-garment loads	Normal	Hot <b>Warm</b> Cold	High	Use this cycle for normally soiled cottons and mixed-fabric loads. Good <span style="float:right">Best</span> Cleaning Gentleness Efficiency†
Heavily soiled fabrics	Whites	Hot <b>Warm</b> Cold	High	Use this cycle for heavily soiled white fabrics. Good <span style="float:right">Best</span> Cleaning Gentleness Efficiency†
Large items such as sheets, sleeping bags, small comforters	Bedding	Hot <b>Warm</b> Cold	Low	Use this cycle to wash large items such as small comforters. The washer will fill with enough water to wet down the load before the wash portion of the cycle begins and uses a higher water level than other cycles. Good <span style="float:right">Best</span> Cleaning Gentleness Efficiency†
Heavily soiled, colorfast fabrics	Sanitize w/ Oxi & Steam*	Hot <b>Warm</b> Cold	High	Use this cycle to eliminate 99.9% of bacteria when used in conjunction with the Oxi option. Preset cycle settings must be used to achieve the proper sanitization. Be sure to add an Oxi product to the Oxi dispenser. Good <span style="float:right">Best</span> Cleaning Gentleness Efficiency†
Swimsuits and items requiring rinsing without detergent	Rinse & Spin	Cold Rinse Only	High	Combines a rinse and spin for loads requiring an additional rinse cycle or to complete a load after power interruption. Also use for loads that require rinsing only. To use a spin only, turn off the Extra Rinse option.
Sturdy fabrics, colorfast items, towels, jeans	PowerWash®	Hot <b>Warm</b> Cold	High	Use this cycle for heavily soiled or sturdy items. Water level sensing process may take longer for some items than for others because they will absorb more water than other fabric types. Good <span style="float:right">Best</span> Cleaning Gentleness Efficiency†
No-iron fabrics, cottons, permanent press, linens, synthetics	Wrinkle Control	Hot <b>Warm</b> Cool Cold	Low	Use this cycle to wash loads of no-iron fabrics such as sport shirts, blouses, casual business clothes, permanent press, and blends.



Items to wash:	Cycle:	Wash Temp:	Spin Speed:	Cycle Details:
Machine-wash silks, lingerie, washable wools	Delicates	Hot Warm Cold	Low	Use this cycle to wash lightly soiled items indicating "Machine Washable Silks" or "Gentle" cycle on the care label. Place small items in mesh garment bags before washing.  Good <span style="float: right;">Best</span> Cleaning  Gentleness  Efficiency† 
Lightly soiled fabrics	Rapid Wash	Hot Warm Cold	High	Use this cycle to quickly clean a small number of lightly soiled items.  Good <span style="float: right;">Best</span> Cleaning  Gentleness  Efficiency† 
No clothes in washer	Clean Washer with affresh®	Hot Warm Cold	Low	Use this cycle every 30 washes to keep the inside of your washer fresh and clean. This cycle uses a higher water level. Use with affresh® Washer Cleaner tablet or liquid chlorine bleach to thoroughly clean the inside of your washer. This cycle should not be interrupted. See "Washer Care" in the "Washer Maintenance" section.  <b>IMPORTANT:</b> Do not place garments or other items in the washer during the Clean Washer with affresh® cycle. Use this cycle with an empty wash tub.

\*Extended hot water cycle intended to help sanitize items such as sheets and towels. This cycle is not recommended for all fabrics. For best results, this cycle should be run to completion to ensure sanitation and should not be interrupted.

†Efficient use of resources, such as energy and water.

## USING YOUR WASHER

### Warning - Fire Hazard

- Never place items in the washer that are dampened with gasoline or other flammable fluids.
- No washer can completely remove oil.
- Do not dry anything that has ever had any type of oil on it (including cooking oils).
- Doing so can result in death, explosion, or fire.

### Warning - Electronic Shock Hazard

- Plug into a grounded 3 prong outlet.
- Do not remove ground prong.
- Do not use an adapter.
- Do not use an extension cord.
- Failure to follow these instruction can result in death, fire, or electrical shock.

## 1. Sort and prepare your laundry

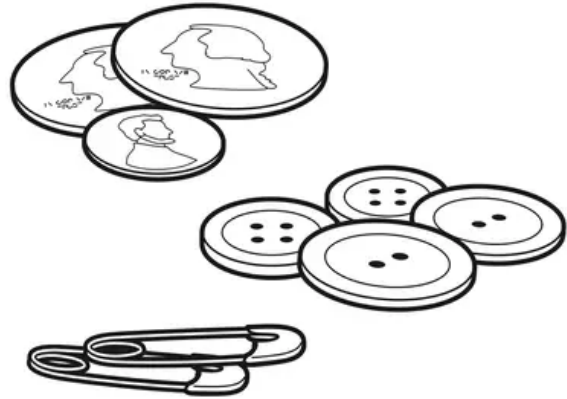

- Empty pockets. Loose change, buttons, or any small object can pass under the washplate and become trapped, causing unexpected sounds.
- Sort items by recommended cycle, water temperature, and colorfastness.
- Separate heavily soiled items from lightly soiled.
- Separate delicate items from sturdy fabrics.
- Do not dry items if stains remain after washing; heat can set stains into fabric.
- Treat stains promptly.
- Close zippers, fasten hooks, tie strings and sashes.  
Remove non-washable trim and ornaments.
- Mend rips and tears to avoid further damage to items during washing.

### Helpful Tips:

- For best performance, use HE liquid detergent when washing bulky items.
- When washing waterproof or water-resistant items, load evenly.
- Use mesh bags to help avoid tangling when washing delicate or small items.
- Turn knits inside out to avoid pilling. Separate lint-takers from lint-givers. Synthetics, knits, and corduroy fabrics will pick up lint from towels, rugs, and chenille fabrics.
- Wash large, absorbent items with other water absorbent items or alone. Do not mix water absorbent items with items that do not absorb water as this can cause imbalance.

**NOTE:** Always read and follow fabric care labels instructions to avoid damage to your items.

## 2. Add laundry products

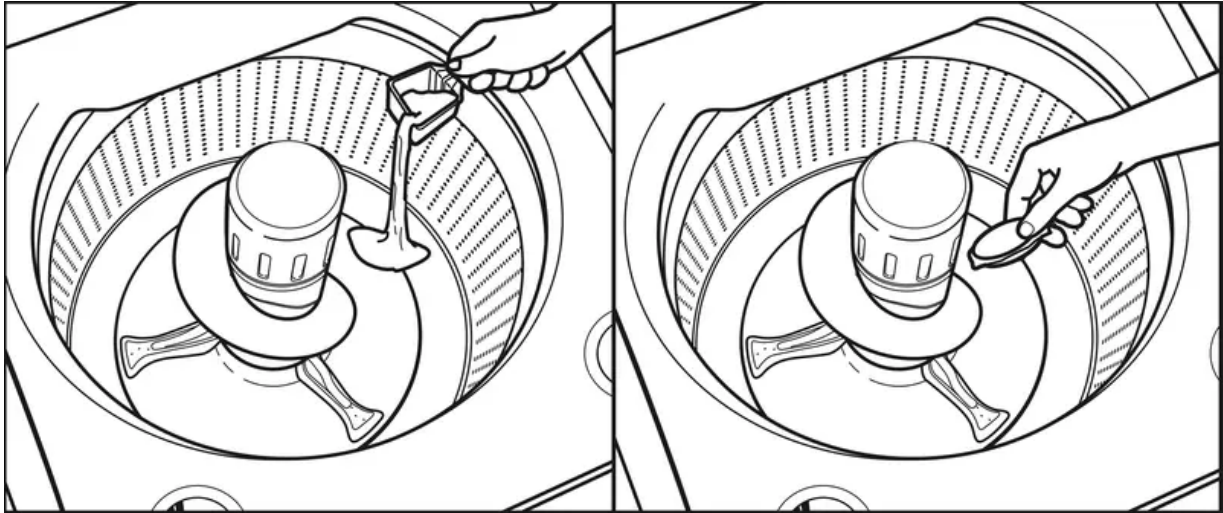

Single-dose laundry packets, powder detergent, or fabric softener crystals can be added to the basket prior to adding laundry.

**NOTE:** Always follow manufacturer's instructions, and never add single-dose laundry packets, powder detergent, or fabric softener crystals to the dispensers. They will not dispense correctly. Add to the basket prior to adding laundry.

## 3. Load laundry into washer

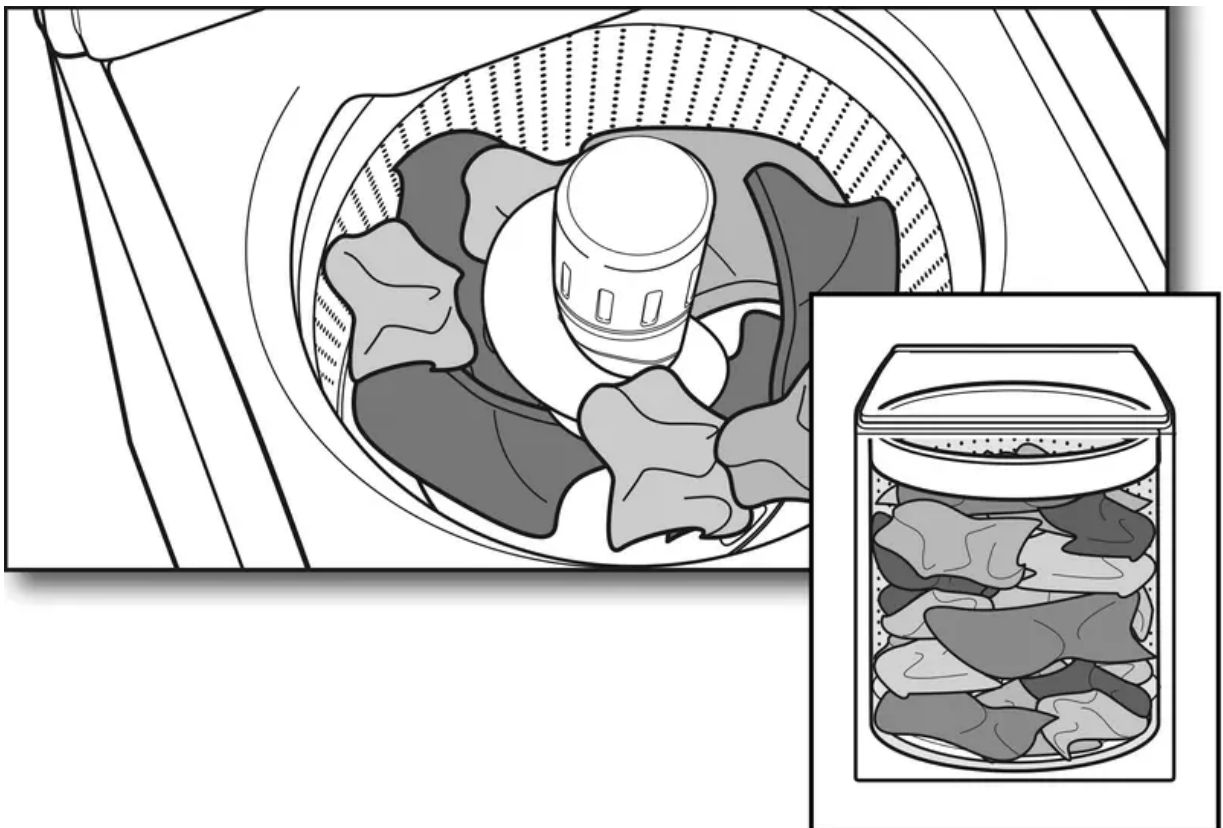

For best performance, load items in loose heaps evenly around the agitator. Try mixing different sized items to reduce tangling.

**IMPORTANT:** Items need to move freely for best cleaning and to reduce wrinkling and tangling.

**4. Add HE liquid detergent**

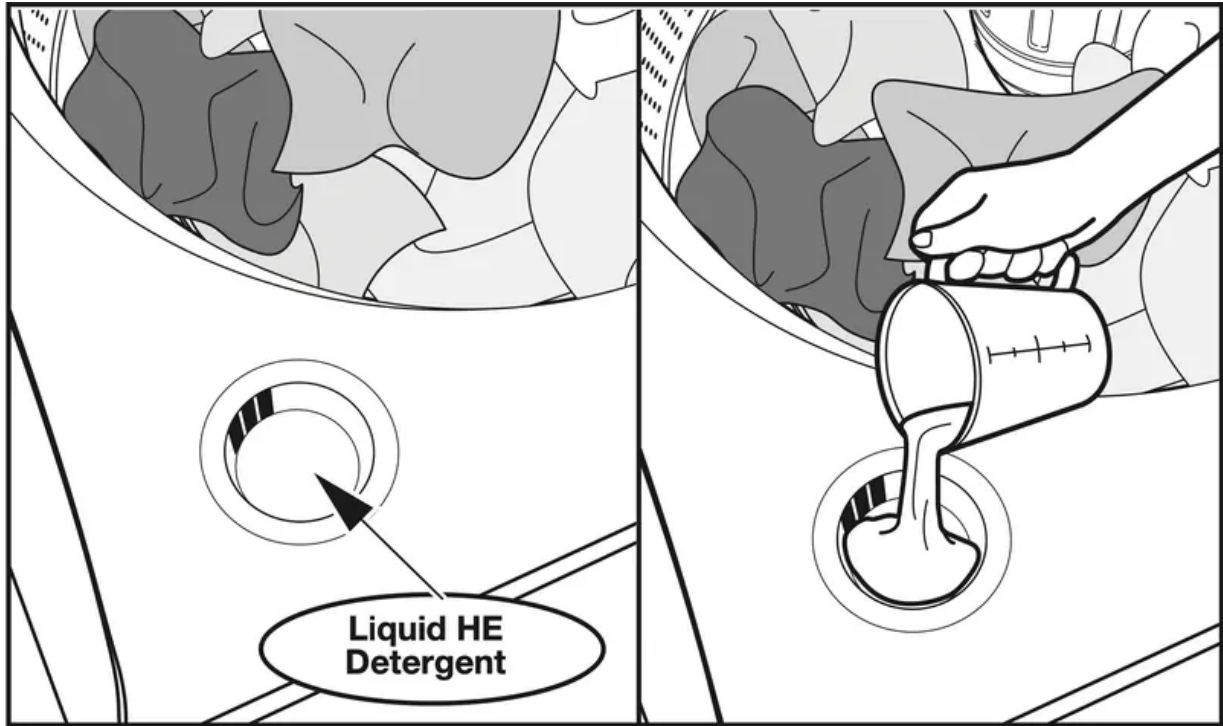

Pour a measured amount of HE detergent into dispenser; always follow manufacturer's directions for correct amount of detergent based on your load size.

**5. Add liquid chlorine bleach or Oxi to dispenser (if desired)**

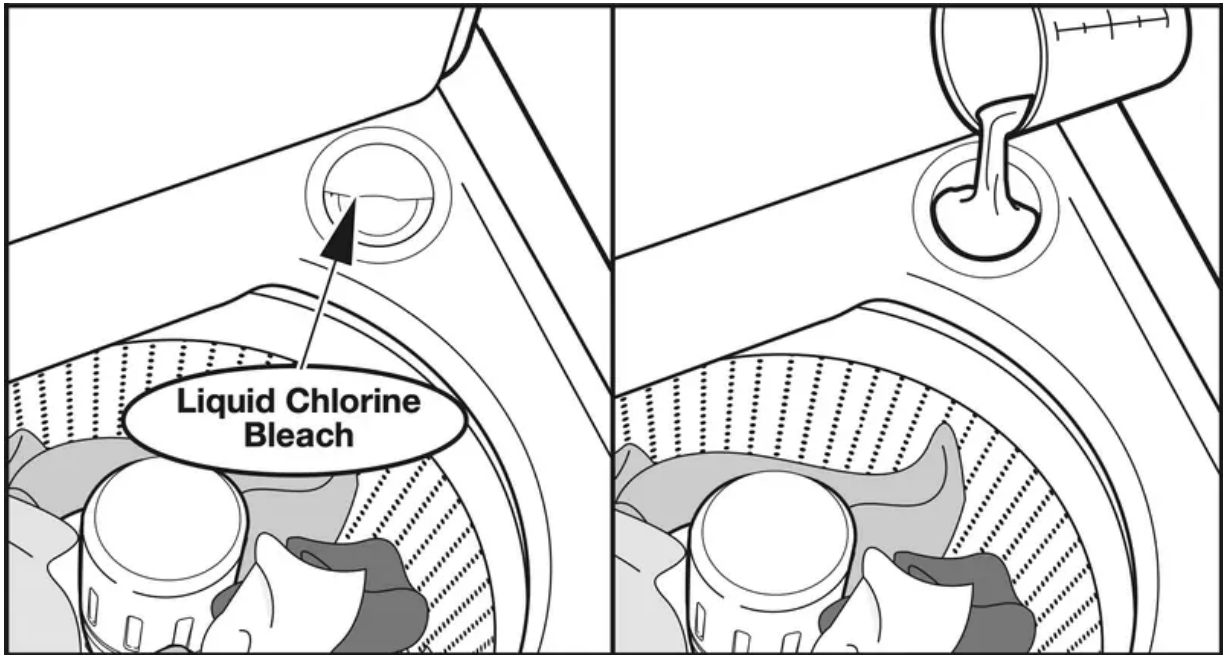

Do not overfill, dilute, or use more than 1 cup (236 mL) of liquid chlorine bleach. Pour a measured amount of Oxi-type boosters, into dispenser; always follow manufacturer's directions for correct amount of Oxi-based boosters based on your load size. Oxi is added during main wash.

**IMPORTANT:** Do not use color-safe bleach or Oxi products in the same cycle with liquid chlorine bleach. Oxi option must be selected to ensure proper distribution at correct time in cycle.

## 6. Add liquid fabric softener to dispenser (if desired)

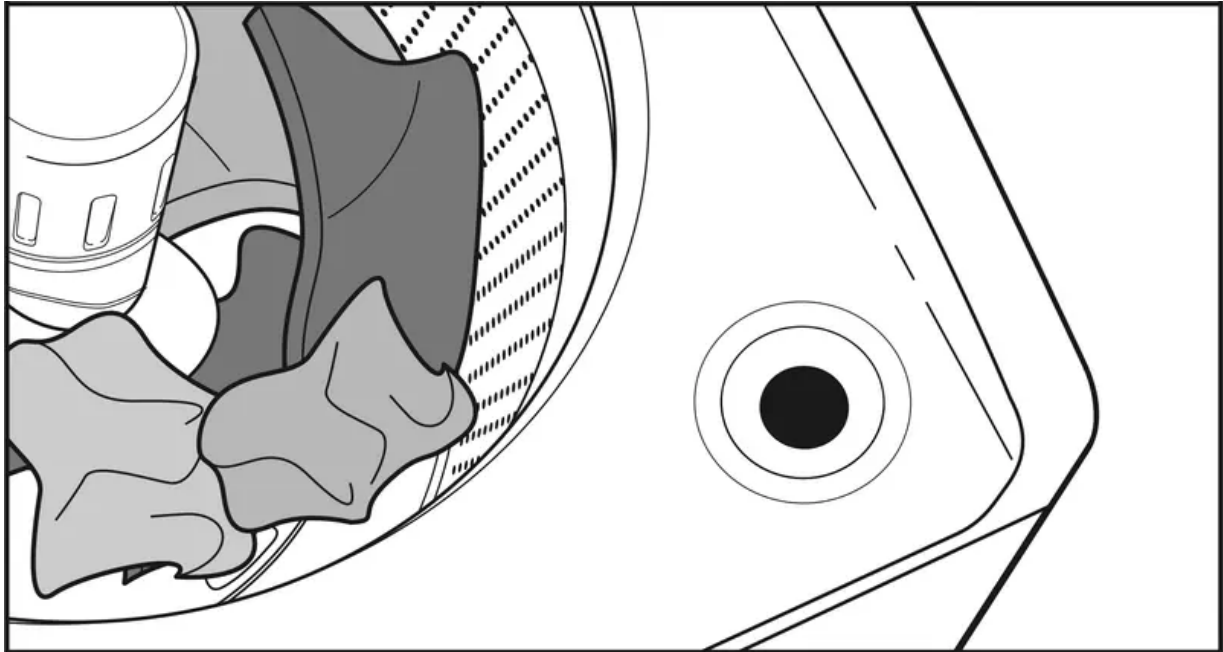

Pour a measured amount of liquid fabric softener into dispenser; always follow manufacturer's directions for correct amount of fabric softener based on your load size. Fabric Softener is added during rinse.

**IMPORTANT:** Do not overfill or dilute. Overfilling dispenser will cause fabric softener to immediately dispense into washer. Do not put fabric softener crystals into dispenser.

If Extra Rinse option is selected, fabric softener will be dispensed into the last rinse. It is normal for a small amount of water to remain in the dispenser at the end of a cycle.

## 7. Touch POWER to turn on washer



Close the lid and touch POWER to turn on the washer.

## 8. Select cycle

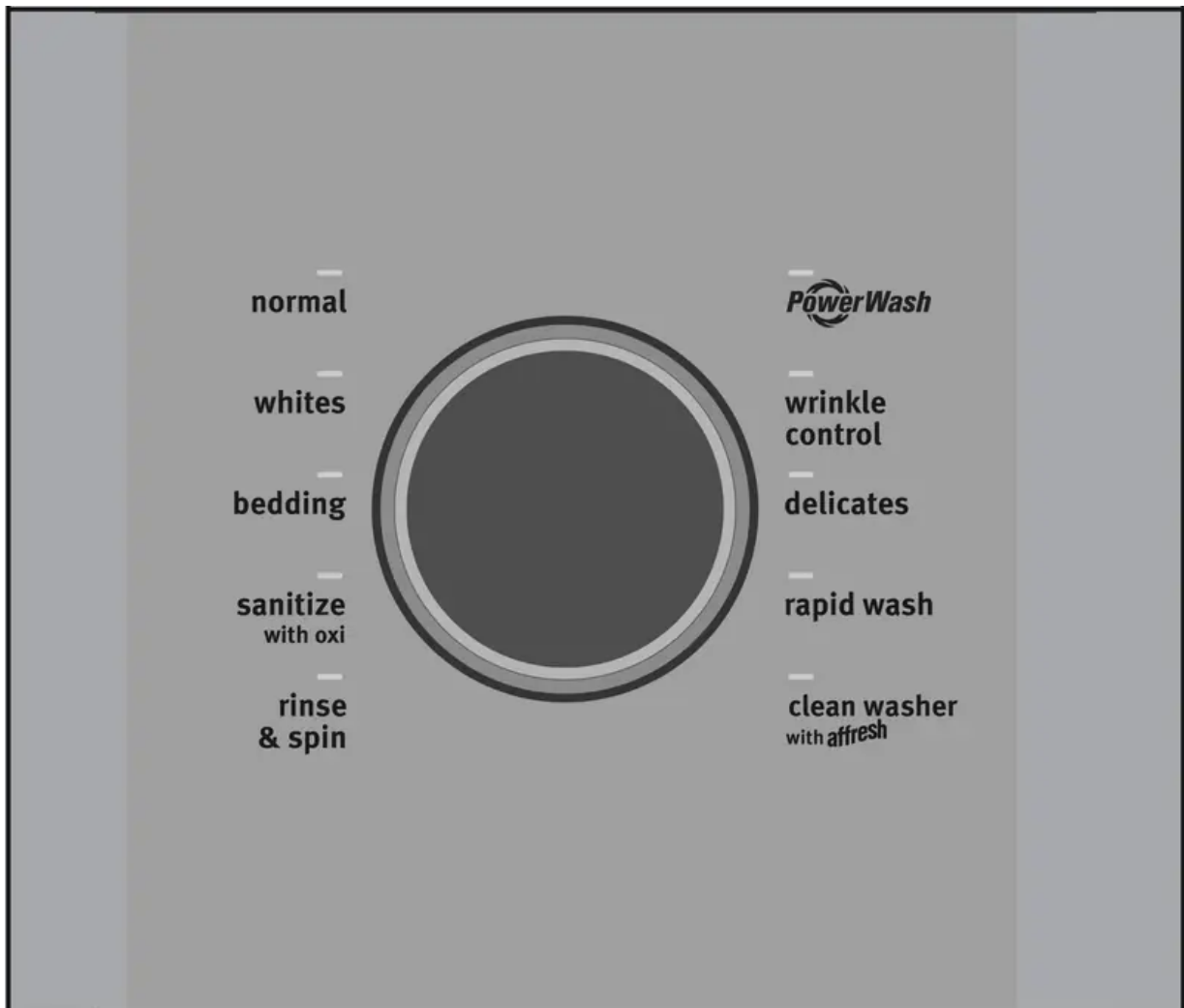



Turn the cycle knob to choose your wash cycle. For more information, see the “Cycle Guide.”

Estimated Time Remaining will light up with a cycle time. You may notice time adjusting during the cycle. This is normal.

If you do not want to begin a cycle immediately, you may choose Delay Start option.

**To choose a delay time:**

1. Touch DELAY START button to select desired delay time.  
Time will increase in hour increments up to 12 hours.
2. Touch and hold the START/PAUSE button to start delay start time.

**IMPORTANT:** When delaying a cycle, use liquid HE detergent only in the dispenser. Powdered detergents may absorb moisture from a previous cycle and clump before the wash cycle begins.

**To cancel Delay Start:**

1. Touch POWER to cancel Delay Start.

**To pause Delay Start:**

1. Touch the START/PAUSE button to pause Delay Start.
2. Touch and hold the START/PAUSE button again to start Delay Start time.

## 9. Select cycle modifiers

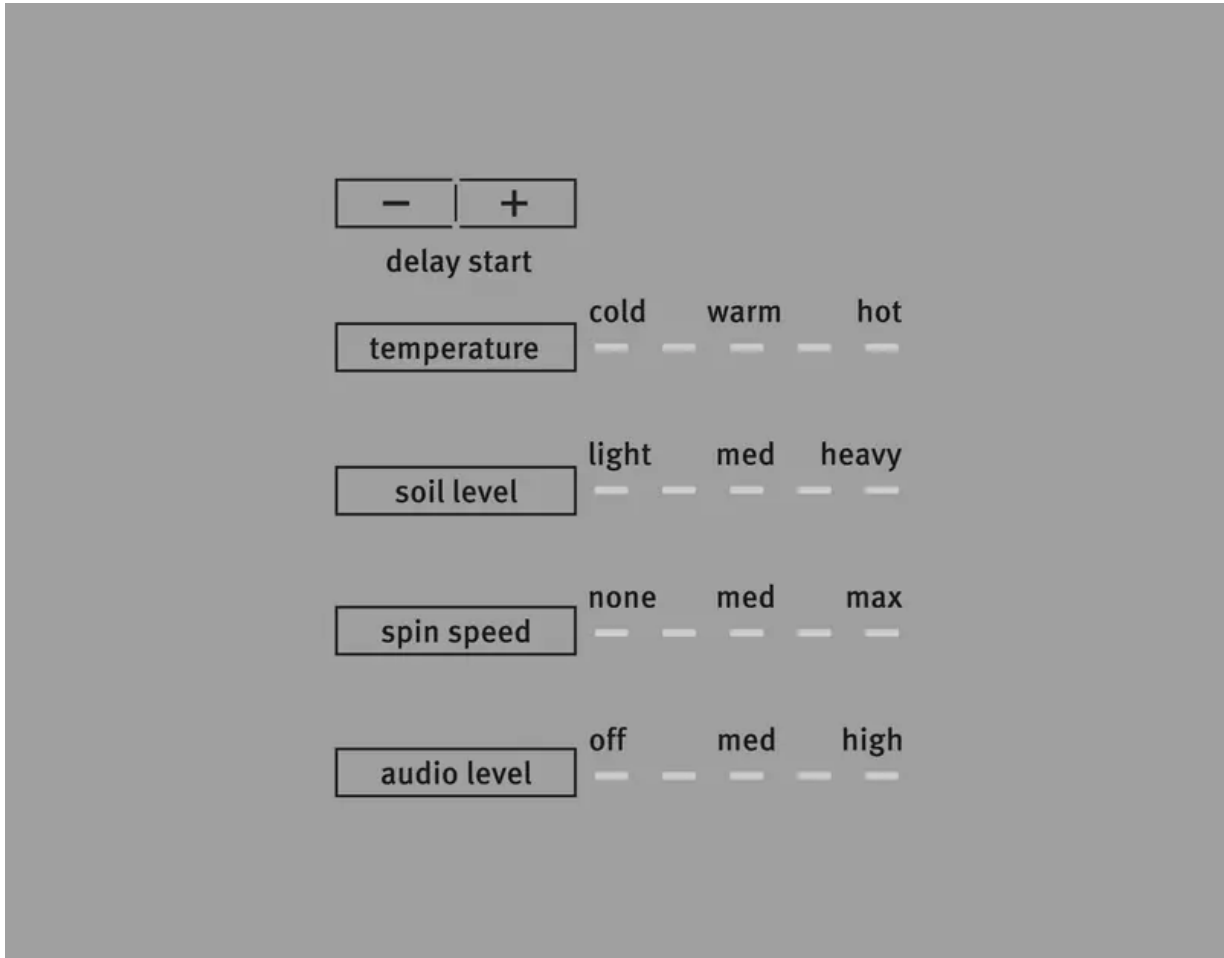

Once you select a cycle, the default modifiers or the previous set modifiers for that cycle will be lit. Touch the cycle settings buttons to change the Temperature, Soil Level, and Spin Speed, if desired. Not all settings are available with all cycles.

**NOTE:** Always read and follow fabric care labels instructions to avoid damage to your items. If not sure which temperature to use, refer to the chart below or select a cooler temperature.

### Temperature suggestions

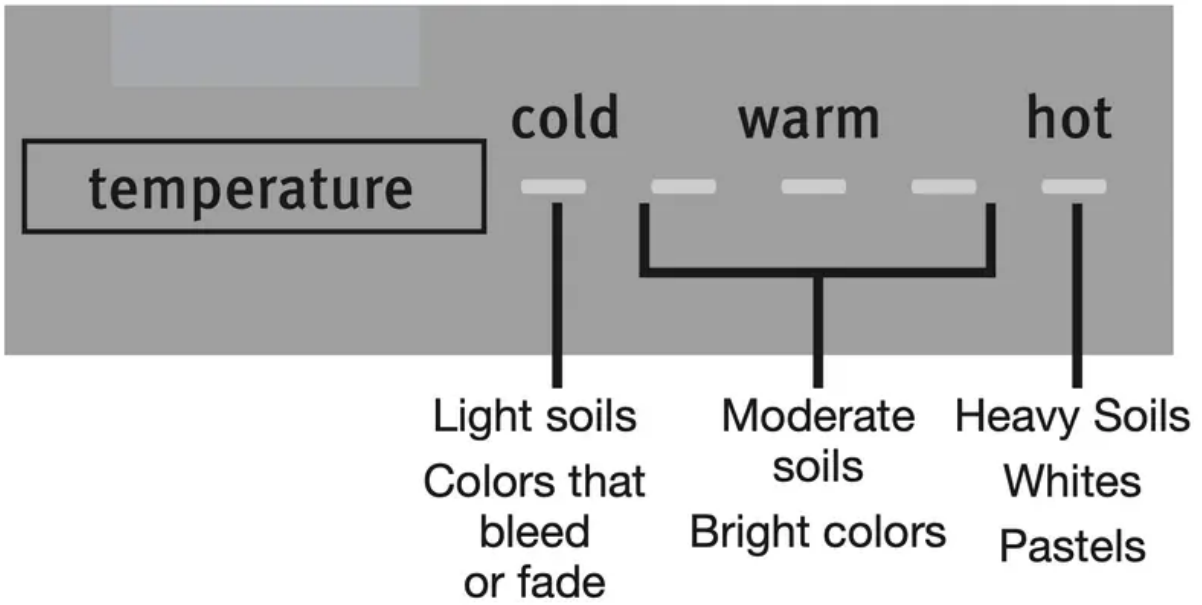

**NOTE:** Even for cold wash settings, some warm water may be added to the washer to maintain a minimum temperature.

### 10. Select cycle options

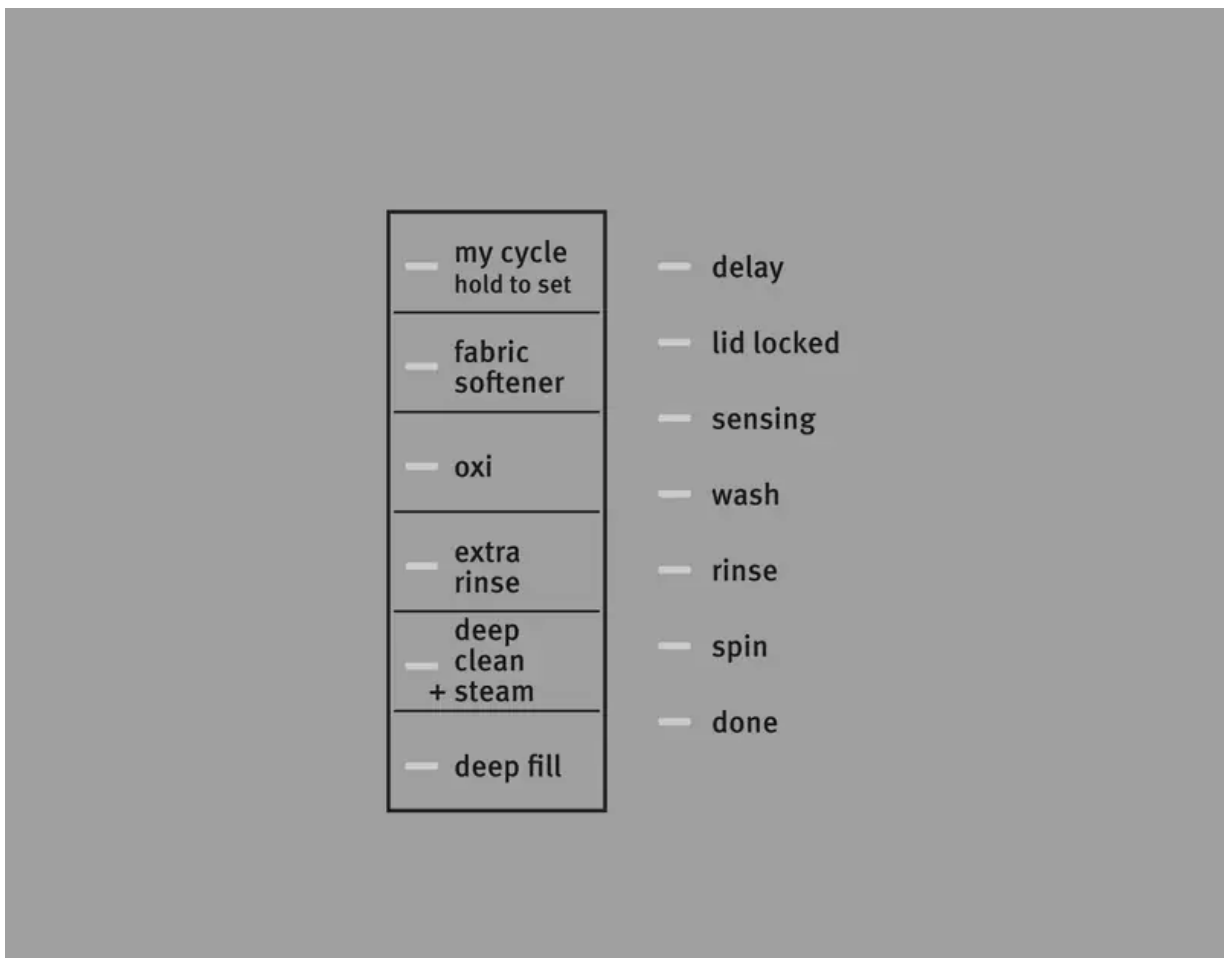

Select any other cycle options you may wish to add, if not previously set. Some cycles will automatically add certain options such as Extra Rinse. These may be turned off, if desired.

**NOTE:** Not all options are available with all cycles. Touch control panel to select any other options.

## 11. Touch and hold START/PAUSE button to begin wash cycle

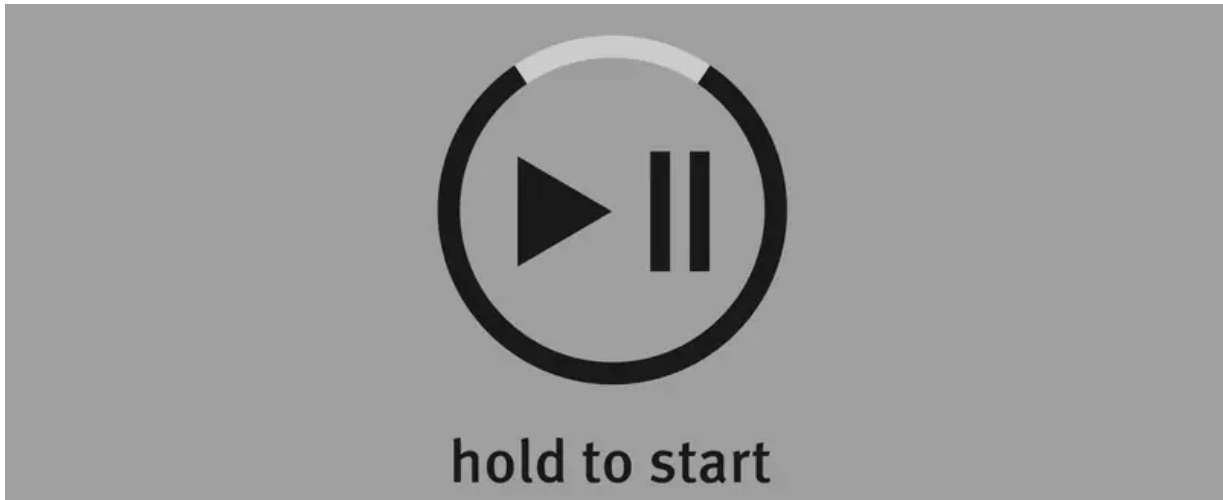

Touch and hold the START/PAUSE button to start the wash cycle. When the cycle has finished, the end of cycle signal will sound (if set). Promptly remove items when cycle is done to avoid odor, reduce wrinkling, and rusting of metal hooks, zippers, and snaps.

Unlocking the lid to add items If you need to open the lid to add one or two missed items:

Touch START/PAUSE button to pause washer; the lid will unlock once the washer movement has stopped. This may take several minutes if the load was spinning at a high speed. Then close the lid and touch and hold the START/PAUSE button again to restart the cycle.

**IMPORTANT:** If lid is left open for more than 10 minutes, the water will pump out and the F8E6 error code will appear on the display.

## WASHER MAINTENANCE

### WATER INLET HOSES

Replace inlet hoses after 5 years of use to reduce the risk of hose failure. Periodically inspect and replace inlet hoses if bulges, kinks, cuts, wear, or leaks are found.

When replacing your inlet hoses, mark the date of replacement on the label with a permanent marker.

**NOTE:** This washer does not include inlet hoses. See the Installation Instructions for more information.

## WASHER CARE

### Recommendations to Help Keep Your Washer Clean and Performing at its Best

1. Always use High Efficiency (HE) detergents and follow the HE detergent manufacturer's instructions regarding the amount of HE detergent to use. Never use more than the recommended amount because that may increase the rate at which detergent and soil residue accumulate inside your washer, which in turn may result in undesirable odor.
2. Use warm and hot wash water settings sometimes (not exclusively cold water washes), because they do a better job of controlling the rate at which soils and detergent accumulate.
3. Always leave the washer lid open between uses to help dry out the washer and prevent the buildup of odor-causing residue.

### Cleaning Your Top Loading Washer

Read these instructions completely before beginning the routine cleaning processes recommended below.

This Washer Maintenance Procedure should be performed, at a minimum, once per month or every 30 wash cycles, whichever occurs sooner, to control the rate at which soils and detergent may otherwise accumulate in your washer.

### Cleaning the Inside of the Washer

To keep your washer odor-free, follow the usage instructions provided above, and use this recommended monthly cleaning procedure:

#### Clean Washer Cycle

This washer has a special cycle that uses higher water volumes in combination with affresh® Washer Cleaner or liquid chlorine bleach to clean the inside of the washer.

#### Begin procedure

1. affresh® Washer Cleaner Cycle Procedure (Recommended for Best Performance):
  - a. Open the washer lid and remove any clothing or items.
  - b. Place an affresh® Washer Cleaner tablet in the bottom of the washer basket.
  - c. Do not place an affresh® Washer Cleaner tablet in the detergent dispenser.
  - d. Do not add any detergent or other chemical to the washer when following this procedure.
  - e. Close the washer lid.
  - f. Touch POWER to turn on the washer.
  - g. Select the Clean Washer cycle.
  - h. Touch and hold the START/PAUSE button to begin the cycle. The Clean Washer Cycle Operation is described below.

**NOTE:** For best results, do not interrupt cycle. If cycle must be interrupted, touch

POWER. After the Clean Washer cycle has stopped, run a Rinse & Spin cycle to rinse cleaner from washer.

2. Chlorine Bleach Procedure (Alternative):

a. Open the washer lid and remove any clothing or items.

b. Add 1 cup (236 mL) of liquid chlorine bleach to the bleach compartment.

**NOTE:** Use of more liquid chlorine bleach than is recommended above could cause washer damage over time.

c. Close the washer lid.

d. Do not add any detergent or other chemical to the washer when following this procedure.

e. Touch POWER to turn on the washer.

f. Select the Clean Washer cycle.

g. Touch and hold the START/PAUSE button to begin the cycle. The Clean Washer Cycle Operation is described below.

**NOTE:** For best results, do not interrupt cycle. If cycle must be interrupted, touch POWER. After the Clean Washer cycle has stopped, run a Rinse & Spin cycle to rinse cleaner from washer.

**Description of Clean Washer Cycle Operation:**

1. This cycle will fill to a water level higher than in normal wash cycles to provide rinsing at a level above the water line for normal wash cycle.
2. During this cycle, there will be some agitation and spinning to increase the removal of soils.

After this cycle is complete, leave the lid open to allow for better ventilation and drying of the washer interior.

**Cleaning the Outside of the Washer**

Use an affresh® Machine Cleaning Wipe or a soft, damp cloth or sponge to wipe away any spills. Use only mild soaps or cleaners when cleaning external washer surfaces.

**IMPORTANT:** To avoid damaging the washer's finish, do not use abrasive products.

**NON-USE AND VACATION CARE**

Operate your washer only when you are home.

If moving, or not using your washer for a period of time, follow these steps:

1. Unplug or disconnect power to washer.
2. Turn off water supply to washer, to avoid flooding due to water pressure surge.



## **WINTER STORAGE CARE**

**IMPORTANT:** To avoid damage, install and store washer where it will not freeze. Because some water may stay in hoses, freezing can damage washer. If storing or moving during freezing weather, winterize your washer.

### **To winterize washer:**

1. Shut off both water faucets; disconnect and drain water inlet hoses.
2. Put 1 qt. (1 L) of R.V.-type antifreeze in basket and run washer on Rinse & Spin cycle for about 30 seconds to mix antifreeze and remaining water.
3. Unplug washer or disconnect power.

## **TRANSPORTING YOUR WASHER**

1. Shut off both water faucets. Disconnect and drain water inlet hoses.
2. If washer will be moved during freezing weather, follow “Winter Storage Care” directions before moving.
3. Disconnect drain from drain system.
4. Unplug power cord.
5. Place inlet hoses inside washer basket.
6. Drape power cord and drain hose over the console and secure with masking tape.
7. Place foam packing ring from original shipping materials back inside washer. If you do not have packing ring, place heavy blankets or towels into basket opening. Close lid and place tape over lid and down front of washer. Keep lid taped until washer is placed in new location. Transport washer in the upright position.

### **Warning - Electronic Shock Hazard**

- Plug into a grounded 3 prong outlet.
- Do not remove ground prong.
- Do not use an adapter.
- Do not use an extension cord.
- Failure to follow these instruction can result in death, fire, or electrical shock.

## **REINSTALLING/USING WASHER AGAIN**

### **To reinstall washer after non-use, vacation, winter storage or moving:**

1. Refer to Installation Instructions to locate, level, and connect washer.
2. Before using again, run washer through the following recommended procedure:

**To use washer again:**

1. Flush water pipes and hoses. Reconnect water inlet hoses. Turn on both water faucets.
2. Plug in washer or reconnect power.
3. Run washer through PowerWash<sup>®</sup> cycle to clean washer and remove antifreeze, if used. Use only HE High Efficiency detergent. Use half the manufacturer's recommended amount for a medium-size load.

# TROUBLESHOOTING



If you experience	Possible Causes	Solution
<b>Vibration or Off-Balance</b>		
Vibration, rocking, or “walking”	Feet may not be in contact with the floor and locked.	Front and rear feet must be in firm contact with floor, and washer must be level to operate properly.
	Washer may not be level.	Check floor for flexing or sagging. If flooring is uneven, a 3/4" (19 mm) piece of plywood under your washer will reduce sound.
		See “Level the Washer” in the Installation Instructions.
Vibration during spinning or washer stopped	Load could be unbalanced.	Load items in loose heaps evenly around the agitator. Adding wet items to washer or adding more water to basket could unbalance washer.
		Avoid washing single items. Balance a single item such as a rug or jeans jacket with a few extra items. Redistribute the load, close the lid, and touch and hold START/PAUSE.
		Use Bedding cycle for oversized, non-absorbent items such as comforters or poly-filled jackets. Other items are not appropriate for Bedding cycle. See the “Cycle Guide.”
		Item or load not suitable for selected cycle. See “Cycle Guide” and “Using Your Washer.”
<b>Noises – For normal operating sounds</b>		



Clicking or metallic noises	Objects may be caught in washer drain system.	Empty pockets before washing. Loose items such as coins could fall between basket and tub or may block pump. It may be necessary to call for service to remove items.
		It is normal to hear metal items on clothing such as metal snaps, buckles, or zippers touch against the stainless steel basket.
Gurgling or humming	Washer may be draining water.	It is normal to hear the pump making a continuous humming sound with periodic gurgling or surging as final amounts of water are removed during the spin/drain cycles.
Humming	Load sensing may be occurring.	You may hear the hum of the sensing spins after you have started the washer. This is normal.
Whirring	Basket may be slowing down.	You may hear the whirring sound of the basket slowing down. This is normal.
<b>Water Leaks</b>		
Check the following for proper installation:	Washer not level.	See Installation Instructions for details on how to level your washer.
	Fill hoses not attached tightly.	Tighten fill-hose connection.
	Fill hose washers.	Make sure all four fill hose flat washers are properly seated.
	Drain hose connection.	Pull drain hose from washer cabinet and properly secure it to drainpipe or laundry tub.



		Do not place tape over drain opening.
	Check household plumbing for leaks or clogged sink or drain.	Water can back up out of a clogged sink or drainpipe. Check all household plumbing for leaks (laundry tubs, drainpipe, water pipes, and faucets.)
	Washer not loaded as recommended.	An unbalanced load can cause basket to be out of alignment and cause water to splash off tub. See "Using Your Washer" for loading instructions.
<b>Washer Not Performing As Expected</b>		
Not enough water in washer	Load not completely covered in water.	This is normal operation for an HE low-water washer. The load will not be completely under water. The washer senses load sizes and adds correct amount of water for optimal cleaning. See "What's Under the Lid."
		Use PowerWash® or Bedding cycle for higher water fill, or select the Deep Fill setting. See "What's Under the Lid" and the "Cycle Guide" chart to match your load with the best cycle.  <b>NOTE:</b> Deep Fill is not available in the Normal cycle mode.
		Run Clean Washer cycle to optimize the water level and wash performance.
Washer won't run or fill, washer stops working	Check for proper water supply.	Both hoses must be attached and have water flowing to inlet valve.
		Both hot and cold water faucets must be turned on.



	<p>Check that inlet valve screens have not become clogged.</p>
	<p>Check for any kinks in inlet hoses, which can restrict water flow.</p>
<p>Check proper electrical supply.</p>	<p>Plug power cord into a grounded 3 prong outlet.</p>
	<p>Do not use an extension cord.</p>
	<p>Ensure there is power to outlet.</p>
	<p>Reset a tripped circuit breaker. Replace any blown fuses.</p> <p><b>NOTE:</b> If problems continue, contact an electrician.</p>
<p>Normal washer operation.</p>	<p>Lid must be closed for washer to run.</p>
	<p>Washer will pause during certain phases of cycle. Do not interrupt cycle.</p>
	<p>Washer may be stopped to reduce suds.</p>
<p>Washer may be tightly packed.</p>	<p>Remove several items, rearrange load evenly around the agitator. Close lid, touch and hold START/PAUSE button.</p>
	<p>Add only one or two additional items after washer has started.</p>
	<p>Do not add more water to the washer.</p>
	<p>Only use HE detergent (liquid only in the dispenser). Suds from regular detergents</p>



	<p>Not using HE detergent or using too much HE detergent.</p>	<p>can slow or stop the washer. Always measure detergent and following detergent directions based on your load requirements.</p>
<p>Washer not draining/spinning, loads are still wet</p>	<p>Small items may have been caught in pump or between basket and tub, which can slow draining.</p>	<p>Empty pockets and use garment bags for small items.</p>
	<p>Using cycles with a lower spin speed.</p>	<p>Cycles with lower spin speeds remove less water than cycles with high spin speeds. Use the recommended cycle/speed spin for your item.</p>
	<p>Washer may be tightly packed or unbalanced.</p>	<p>Tightly packed loads may not allow the washer to spin correctly, leaving the load wetter than normal. Evenly arrange the wet load for balanced spinning. Select Rinse &amp; Spin to remove excess water. See “Using Your Washer” for loading recommendations.</p>
	<p>Load off-balance.</p>	<p>See “Vibration or Off-Balance” in Troubleshooting section for more information.</p>
	<p>Check plumbing for correct drain hose installation. Drain hose extends into standpipe farther than 4.5" (114 mm).</p>	<p>Check drain hose for proper installation. Use drain hose form and securely attach to drainpipe or tub. Do not tape over drain opening. Lower drain hose if the end is higher than 96" (2.4 m) above the floor. Remove any clogs from drain hose.</p>
		<p>Suds from regular or too much detergent can slow/stop draining or spinning. Use</p>



	Not using HE detergent or using too much HE detergent.	only HE detergent. Always measure and follow directions for your load. To remove extra suds, Select Rinse & Spin.
Incorrect or wrong wash or rinse temperatures	Check for proper water supply.	Make sure hot and cold inlet hoses are not reversed.
		Both hoses must be attached to both washer and faucet, and have both hot and cold water flowing to inletvalve.
		Check that inlet valve screens are not clogged.
		Remove any kinks in hoses.
	Energy-saving controlled wash temperatures.	ENERGY STAR® qualified washers use cooler wash and rinse water temperatures than traditional top-load washers. This includes cooler hot and warm washes.
Load not rinsed	Check for proper water supply.	Make sure hot and cold inlet hoses are not reversed.
		Both hoses must be attached and have water flowing to the inlet valve.
		Both hot and cold water faucets must be on.
		Inlet valve screens on washer may be clogged.
		Remove any kinks in the inlet hose.



	<p>Not using HE detergent or using too much HE detergent.</p>	<p>The suds from regular detergent can cause the washer to operate incorrectly.</p> <p>Use only HE detergent (liquid only in the dispenser). Be sure to measure correctly.</p> <p>Always measure detergent and follow detergent directions based on load size and soil level.</p>
	<p>Washer may be tightly packed.</p>	<p>The washer is less efficient at rinsing when load is tightly packed.</p> <p>Load items in loose heaps evenly around the agitator.</p> <p>Use cycle designed for the fabrics being washed.</p> <p>Add only one or two additional items after washer has started.</p>
<p>Sand, pet hair, lint, etc. on load after washing</p>	<p>Heavy sand, pet hair, lint, and detergent or bleach residues may require additional rinsing.</p>	<p>Add an Extra Rinse to the selected cycle.</p>
<p>Load is tangling</p>	<p>Washer not loaded as recommended.</p>	<p>Load items in loose heaps evenly around the agitator.</p> <p>Reduce tangling by mixing types of load items. Use the recommended cycle for the type of items being washed.</p>
	<p>Wash action and/or spin speed too fast for load.</p>	<p>Select a cycle with a slower wash action and slower spin speed. Note that items will</p>



		be wetter than when using a higher speed spin.
Not cleaning or removing stains	Added more water to washer.	Washer senses load size and adds correct amount of water. This is normal and necessary for clothes to move. It is normal for the wash load to be not completely covered in water. Extra water, added manually, results in less effective cleaning.
	Washer not loaded as recommended.	Washer is less efficient at cleaning when load is tightly packed.
		Load items in loose heaps evenly around the agitator. Load with dry items only.
		Add only one or two additional items after washer has started.
	Adding detergent on top of load.	Add detergent, Oxi products, and color-safe bleach to the bottom of the basket before adding the load items.
	Not using HE detergent or using too much HE detergent.	The suds from regular detergent can prevent washer from operating correctly.
Use only HE detergent (liquid only in the dispenser). Be sure to measure correctly.		
Always measure detergent and follow detergent directions based on load size and soil level.		
Not using correct cycle for fabric type.	Use a higher soil level cycle option and warmer wash temperature to improve cleaning.	



		<p>If using Rapid Wash cycle, wash only a few items.</p>
		<p>Use PowerWash® cycle for tough cleaning. See the “Cycle Guide” to match your load with the best cycle.</p>
	Not using dispensers.	<p>Use dispensers to avoid chlorine bleach and fabric softener staining.</p>
		<p>Load dispensers before starting a cycle.</p>
		<p>Avoid over filling.</p>
		<p>Do not add products directly onto load.</p>
	Not washing like colors together.	<p>Wash like colors together and remove promptly after the cycle is complete to avoid dye transfer.</p>
Odors	Monthly maintenance not done as recommended.	<p>Run the Clean Washer cycle after every 30 washes. See “Washer Care” in “Washer Maintenance.”</p>
		<p>Unload washer as soon as cycle is complete.</p>
	Not using HE detergent or using too much HE detergent.	<p>Use only HE detergent (liquid only in the dispenser). Be sure to measure correctly.</p>
<p>Always follow the detergent directions.</p>		
<p>See “Washer Care” section.</p>		

Fabric Damage



Sharp items were in pockets during wash cycle.	Empty pockets, zip zippers, and snap or hook fasteners before washing to avoid snags and tears.
Strings and straps could have tangled.	Tie all strings and straps before starting wash load.
Items may have been damaged before washing.	Mend rips and broken threads in seams before washing.
Fabric damage can occur if the load is tightly packed.	Load items in loose heaps evenly around the agitator. Load with dry items only.
	Load items should move freely during wash to avoid damage.
	Use cycle designed for the fabrics being washed.
	Add only one or two additional items after washer has started.
	Use PowerWash ® or Bedding cycle for higher water fill, or select the Deep Fill setting. See “What’s Under the Lid” and the “Cycle Guide” chart to match your load with the best cycle.  NOTE: Deep Fill is not available in the Normal cycle mode.
Garment care instructions may not have been followed.	Always read and follow garment manufacturer’s care label instructions. See the “Cycle Guide” to match your load with the best cycle.
Liquid chlorine bleach may have been added incorrectly.	Do not pour liquid chlorine bleach directly onto load. Wipe up bleach spills.



		<p>Undiluted bleach will damage fabrics. Do not use more than recommended by manufacturer.</p> <p>Do not place load items on top of bleach dispenser when loading and unloading washer.</p> <p>Do not use the liquid chlorine bleach and Oxi products at the same time.</p>
Incorrect dispenser operation	Clogged dispensers or laundry products dispensing too soon.	<p>Do not overfill dispenser. Overfilling causes immediate dispensing.</p> <p>Load dispensers before starting a cycle.</p> <p>It is normal for small amounts of water to be remain in dispenser at the end of the cycle.</p> <p>Homes with low water pressure may result in residual powder in the dispenser. To avoid, select a warmer wash temperature if possible, depending on your load.</p>
Single-dose laundry packet not dissolving	Adding laundry packet incorrectly.	Be sure laundry packet is added to washer basket before adding clothes. Follow the manufacturer's instructions to avoid damage to your items.
<b>Error Code Appears in Display</b>		
"LF" (F8E1) (too long to fill) appears in display	Washer taking too long to fill. Drain extends more than 4.5" (114 mm) into standpipe.	Check plumbing for correct drain hose installation. Use drain hose form and attach securely to drainpipe or tub. Do not tape over drain opening. See Installation Instructions.



F#E# code (F-type error code) appears in display	System error code.	Touch POWER to clear the code and exit cycle. Then touch POWER, select cycle, and then touch and hold START/PAUSE to start washer. If code appears again, call for service.
F1E1 ACU (Appliance control fault)	Internal ACU failure.	Call for service.
F2E3 UI/ACU mismatch	ACU/UI initialization error.	Call for service.
F3E1 Water level sensing failure	Pressure sensor on ACU failure.	Call for service.
F5E2 Lid lock will not lock is lid lock failure	An item in the load may be keeping the lid from locking.	Check for items directly under the lid.
F5E3 Lid cannot unlock	Objects on washer lid prevent it from unlocking.	Remove objects, such as baskets of laundry, from top of washer.
F6E2 or F6E3 Communication Error: UI cannot communicate	ACU or UI synchronization error.	Remove power from the washer. Let washer set for 5 minutes for the washer to completely power down. Apply power to washer and check for error codes. If the error code persists call for service.
F8E6 (Lid opened) appears indisplay	Washer lid left open.	Close the lid and touch POWER to clear the display. If the lid is left open for more than 10 minutes, the cycle will reset and water in the washer will drain.
“drn” “dr” (F9E1) (drain pumpsystem problem – long drain) appears in display	Washer taking too long to drain water. Drain extends more than 4.5" (114 mm) into standpipe.	Check plumbing for correct drain hose installation. Use drain hose form and attach securely to drainpipe or tub. Do not tape over drain opening.

		Lower drain hose if the end is higher than 96" (2.4 m) above the floor. Remove any clogs from drain hose. See Installation Instructions.
"Ofb" (Off Balance)	Load not balanced.	Open the lid, redistribute the load, close the lid, and touch and hold START/PAUSE to resume.

**Warning**

This content is compiled from multiple sources and is provided for reference purposes only. It may not be complete or fully applicable to all situations. If you are unable to resolve your issue, please contact the product manufacturer or an authorized service provider for official support.

