

## Parts and Accessories

Your appliance may vary slightly.

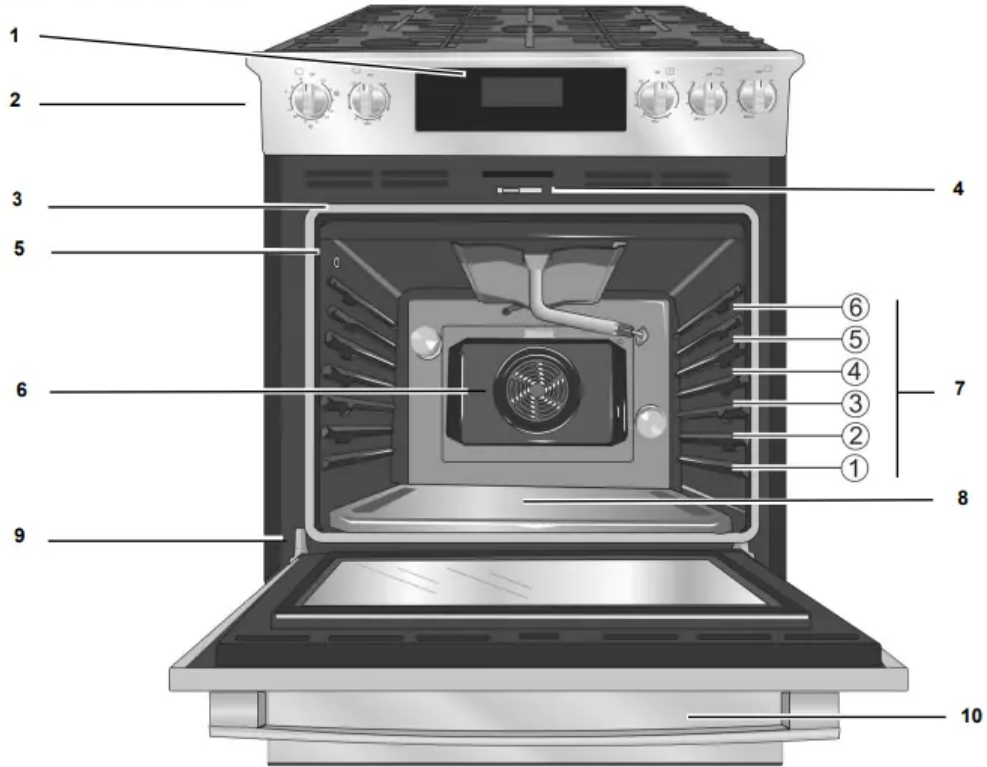

### Range Parts Key

1	Oven Control Panel	7	Rack Position Guides with 6 rack positions
2	Cooktop Control Knobs	8	Oven Bottom
3	Door Gasket	9	Door Hinge
4	Door Latch	10	Warming Drawer
5	Probe Jack (some models)		
6	Convection Fan		

### Probe (some models)

The probe can be used to determine the internal doneness or the end temperature of many foods, especially meats and poultry. Do not clean in the selfclean oven or dishwasher.

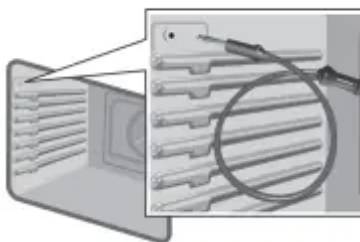

### **Flat Rack**

Use for most cooking. Can use multiple racks in some modes. Do not clean in the selfclean oven.



### **Telescopic Rack (some models) HEZTR301 (available via eShop)**

Use with heavier dishes to make it easier to place dishes into the oven, check on food while cooking and remove dishes from oven when done. Do not clean in the selfclean oven.



### **Broiling Pan Optional accessory (available via eShop)**

Pan: #00449757 Grill (top): #00449756



## **Before Using the Appliance for the First Time**

- Remove all packing materials and labels from range. Remove packing materials from inside the oven and inside the drawer.
- While cool, wipe with a clean, damp sponge and dry.
- There may be a slight odor during first uses; this is normal and will disappear.
- Optimum cooking results depend on proper cookware and bakeware being used.
- Read and understand all safety precautions and Use and Care Manual information prior to operating.

# Operation - Cooktop

## Normal Operation (Electronic Ignition/Reignition)

The cooktop uses electronic igniters to light the burners. There is no pilot light. Each burner has its own igniter. If a burner flame blows out during use, the burner will automatically reignite.

**CAUTION:** To avoid possible injury or damage to the appliance, ensure grates are installed exactly per installation instructions and not backwards or upside down.

## Typical Flame Characteristics

The burner flame should be blue in color and stable with no yellow tips, excessive noise or fluttering. It should burn completely around the burner cap.



**Yellow Flames:** Further adjustment is required.



**Yellow Tips on Outer Cones:** Normal for LP Gas.

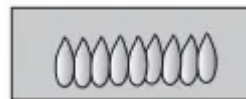

**Soft Blue Flames:** Normal for Natural Gas.

If the flame is completely or mostly yellow, verify that the regulator is set for the correct fuel. After adjustment, retest. Some yellow streaking is normal during the initial startup. Allow unit to operate 4-5 minutes and re-evaluate before making adjustments.

# Operation - Oven

## Oven Control Panel

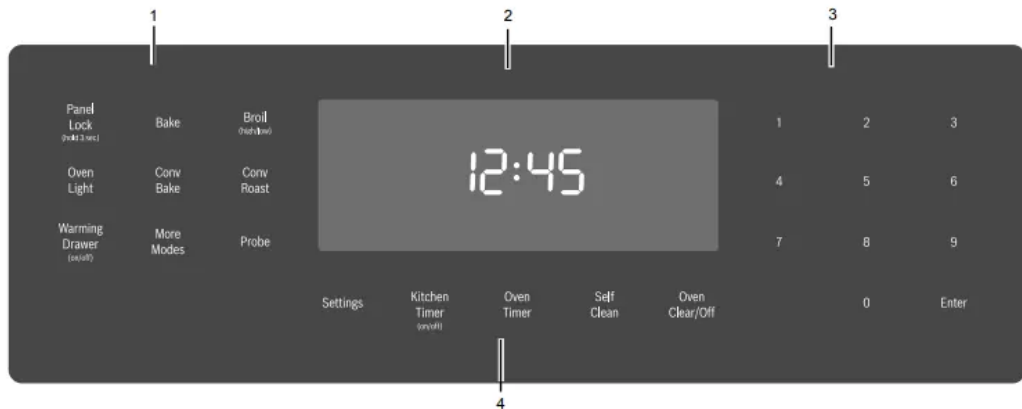

800 Series Oven Control Panel

- 1 Mode Selection Touchpads
- 2 Display
- 3 Numeric Keypad Touchpads

### 4 Special Function Touchpads

#### Touchpads

**Note:** You only need to press lightly on the touchpads to operate them.

## Touchpad Descriptions

<b>Panel Lock</b> (hold 3 sec)	Turns Panel Lock mode on and off.	<b>Oven Timer</b>	Press to edit the oven timer for the selected oven. Turns off the oven at the end of the specified time.
<b>Oven Light</b>	Turns the oven lights on or off.	<b>Settings</b>	Provides access to user settings to allow customization of basic display, language and other features. Use also to set the clock.
<b>Kitchen Timer</b> (on/off)	Starts and stops the kitchen timer(s). Press to edit a timer.	<b>Probe</b>	Sets probe target temperature. Probe allows monitoring of internal meat temperatures during cooking.
<b>Warming Drawer</b> (on/off)	Turns the warming drawer on or off	<b>Self Clean</b>	Activates Self Clean mode.
<b>More Modes</b>	Allows access to cooking/heating modes that do not have a direct access touchpad.		

## Display Symbols



**Door Lock** - Is displayed when the oven door is locked.



**Probe Symbol** - Appears when a probe is detected.



**Panel Lock** - Is displayed when the control panel is locked.



**Self Clean** - Is displayed when Self Clean is active.

---

## Before Using the Oven for the First Time

- Oven must be properly installed by a qualified technician before use.
- Remove all packing materials from inside and outside the oven.
- While cool, wipe with a clean, damp cloth and dry.
- There may be a slight odor during first uses; this is normal and will disappear.
- Optimum cooking results depend on proper bakeware being used.
- Read and understand all safety precautions and Use and Care Manual information prior to operating.

## Setting the Clock

### To set the clock:

1. The oven must be in Stand-By mode (oven is powered on, but no cooking mode or timer in operation).
2. To access the clock set mode: Press the **Settings** touchpad. The display shows "SET CLOCK". Press **Enter** to edit the clock.
3. Use the numeric keypad to enter the desired time. Each number pressed is entered at the right and moving previously entered digits to the left. To set "12:45 pm", press 1, 2, 4, 5.
4. When the desired time is entered, set the time by pressing **Enter**. The clock is now set and running.

## Setting the Cooking Mode and Temperature

To set the Cooking Mode first, then the temperature:

1. Press the desired Cooking Mode Touchpad. The cooking mode and default temperature are displayed. The temperature flashes to show it can be edited.



2. Press **Enter** to start the mode using the default temperature.
3. To change the temperature, enter the new temperature using the numeric touchpads. 375° is used for this example. Press **Enter** to set the updated temperature.

**Note:** The new temperature is automatically set after 10 seconds if **Enter** is not pressed.

4. Preheating starts.

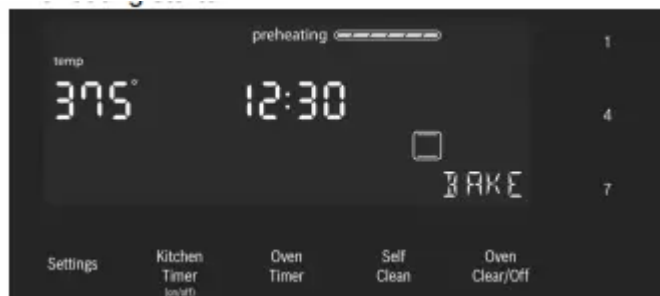

**Note:** If a temperature is entered that is not within the allowed range for the mode, an error tone will sound and the lower part of the screen will display "TEMP NOT ALLOWED".

To set the Temperature first and then the Cooking Mode: (not for Broil)

1. Press the numeric keys to enter the desired temperature setting. The temperature entered is displayed beside the current time.
2. Select a cooking mode that is compatible with the temperature entered. If no cooking mode is selected within 5 seconds of setting the temperature, an error tone sounds and a SELECT MODE message is displayed and blinks.



3. Press a Mode Selection Touchpad to select a cooking mode. The new mode and temperature set automatically after 10 seconds if Enter is not pressed.

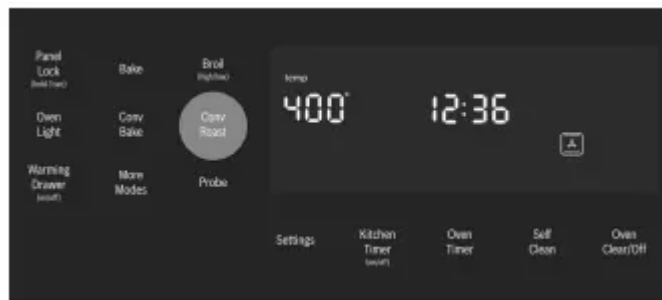

**Note:** If a temperature is entered that is not within the allowed range for the mode selected, an error tone will sound and the lower part of the screen will display “TEMP NOT ALLOWED”.

### To change the Oven Temperature

1. Press the Cooking Mode Touchpad.
2. The current temperature flashes. Use the numeric touchpads to enter a new temperature. Press Enter.

## Timer

Your new oven is equipped with two types of timers.

**Kitchen Timer** - is a countdown timer that has no effect on oven heating. The kitchen timer is used for general kitchen timing needs.

**Oven Timer** - is a countdown timer which upon reaching 00:00 turns the oven off, stopping the current mode. The oven timer is used to set how long a mode will run (not for Broil).

**To set a kitchen timer:** (for general kitchen timer needs)

1. Press the Kitchen Timer On/Off. 0:00 is displayed and blinks in the display. Enter the desired timer value in H/MM format using the numeric keypad.



2. Press Enter. The kitchen timer starts.

3. When the kitchen timer has counted down to zero an alarm tone sounds every 10 seconds for 2 minutes and the message “TIMER END” is displayed.

**Cancel the kitchen timer** - by pressing the Kitchen Timer On/Off button two times.

**Note:** The timer does not change when other settings are changed.

**To edit a kitchen timer:**

1. Press the Kitchen Timer On/Off button once.
2. The current time value blinks and can be edited.

**To set an oven timer:** (for setting a timer to turn the oven off)

Note: An oven timer cannot be run during Self Clean.

1. Press the **Oven Timer** touchpad.
2. Select mode, press **Enter**.

0:00 is displayed and blinks in the display. Enter the desired timer value in H/MM format using the numeric keypad.



Press the Enter touchpad. The oven timer counts down to 0:00.



Ss

3. When the timer reaches :00 the cooking mode ends and the message “OVEN TIMER FINISHED” is displayed. The oven alarm tone sounds every 10 seconds for 2 minutes.

### Editing the oven timer

1. If the oven timer is running and the time remaining needs to be changed, enter the oven timer mode by pressing the **Oven Timer** touchpad.
2. The temperature blinks, indicating it can be edited. Input a new temperature or press **Enter** for no change.
3. The timer value blinks, indicating it can be edited. Input the new time and restart the timer by pressing the **Enter** touchpad. The oven timer may be cleared by entering 0:00.

### Probe (some models)

The probe measures the internal temperature of the food. The probe is available for Bake, Roast and all convection cooking modes.

### Remove Safety Cap before Using

Probe Some models include a temperature probe used to sense internal temperature of meats during cooking. The probe ships with a black plastic safety cap over the pointed metal end of the probe. The cap must be removed prior to use.



Inserting the probe:

Insert the tip of the probe in the middle and thickest part of the meat. Make sure the probe is not touching fat, bone, or parts of the oven or the pan.

**Note:** Food must be completely thawed before inserting the probe into the meat.

**To use the probe:**

1. Insert the probe into the meat as described above. The probe symbol is displayed.
2. Connect the probe to the oven. If the probe is not connected to the oven prior to starting Probe mode, an error tone sounds and the message “INSERT PROBE” is displayed.
3. Set the cooking mode and temperature.
4. The Set Probe Temp screen is displayed. A three digit input prompt “- - -” blinks in the lower right corner. Use the numeric keypad to enter the desired probe temperature and press **Enter** on the numeric keypad.

**Note:** The minimum probe temperature that can be set is 100° F (40° C) and the maximum is 200° F (100° C). If the probe temperature entered is outside this range, an error is displayed.



5. The probe current temperature and target temperature are both displayed in the format “105 / 180” at the lower right corner of the display. The actual temperature will display < 80 until the food temperature reaches 80° F.

The displayed probe temperature is updated in increments of 5° during the cooking process.



6. When the probe temperature reaches the set temperature, the cooking mode turns off. The current time is displayed and the message “COOKING COMPLETE” blinks at the bottom left of the display. An alarm tone sounds every 10 seconds for 2 minutes



This screen remains in the display until it is cleared by pressing the Oven Clear/Off touchpad or until the probe is removed. The display then goes back to stand by mode.

## Sabbath Mode

The Sabbath mode enables those of particular faiths to use their ovens on the Sabbath. The Sabbath mode can be entered in a Bake mode only. The bake temperature must be within the Sabbath mode temperature range of 100° to 450° F. If the oven light is on during setup, it remains on throughout the Sabbath mode operation. If the oven light is off during setup, it remains off throughout the Sabbath mode operation.

### To set the Sabbath Mode:

No kitchen timers or oven timers may be running when Sabbath mode is entered.

1. Begin a Bake operation. While **Bake** is running, press and hold the **Oven Timer** touchpad for five seconds. If a timer is running when Sabbath mode attempts to start, the display blinks the message: "SABBATH NOT AVAILABLE".

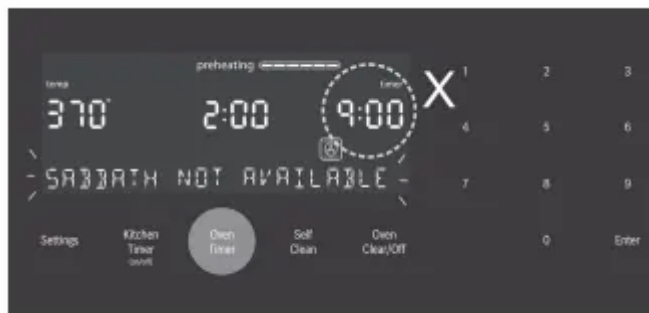

If no timers are running, the Sabbath mode settings appear in the display. The Sabbath Mode timer blinks showing the value can be edited. The default value is 74:00 (the maximum number of hours for which Sabbath Mode can be set.)



2. Press Enter to accept the default 74:00 hours and start Sabbath Mode. Or use the numeric keypad to enter the desired Sabbath mode timer value. Timer values between 0:01 and 74:00 can be entered.

**Note:** If no changes are made within 10 seconds, Sabbath Mode auto starts.

3. Once Sabbath mode has begun, the display changes to show the message “SABBATH ON”.

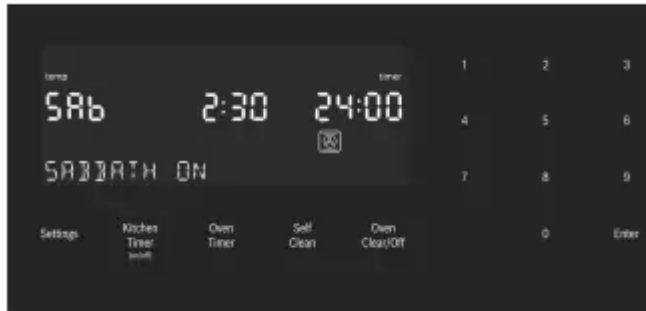

4. After the Sabbath mode countdown reaches zero, the oven displays the current time and the message “SABBATH”. No changes can be made at this point. To end the Sabbath Mode and return to normal function, press the **Oven Clear/Off** touchpad.

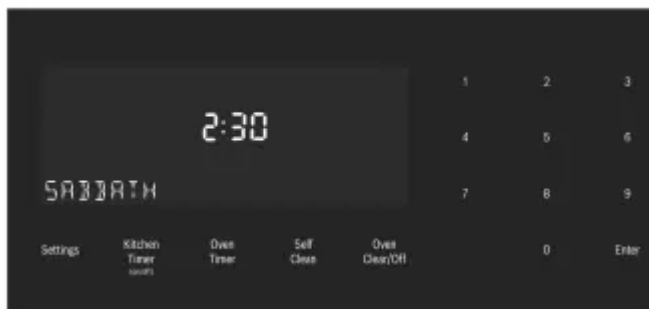

**Note:**

- The temperature range in Sabbath Mode is 100° F to 450° F.
- The Sabbath Mode timer can be set between 0:01 and 74 hours.

#### **To edit the Sabbath Temperature:**

While editing the temperature in Sabbath mode, there is no feedback from the control. If an invalid temperature is set, the oven will default back to the previous running temperature.

1. Press the Bake touchpad.
2. Enter the new desired set temperature.
3. Press Enter. The oven will adjust its set temperature after a randomized delay.

## Panel Lock

Allows the user to disable all buttons on the control panel. Panel Lock can only be enabled in stand by mode.

1. To enable Panel Lock, press and hold the **Panel Lock** touchpad for 3 seconds (in stand by mode).
2. To disable Panel Lock, press and hold the **Panel Lock** touchpad for 3 seconds. The display returns to stand by mode.

## Settings Menu Options

	<b>Menu Item</b>	<b>Description</b>	<b>Default</b>
1	Temperature Mode	Fahrenheit (° F) or Celsius (° C)	°F
2	Brightness	High, Medium, Low	MED
3	Volume	High, Medium, Low	High
4	Clock mode	12-hour or 24-hour display mode. 12HR, 24HR.	12HR
5	Auto Convection Conversion	Decreases oven temperature by 25 degrees set for convection cooking modes, Convection Bake. On, Off.	OFF
6	Button Beep	Tone when touchpad is pressed. On, Off.	ON
7	Stand by Clock Display	Clock displays when no cooking mode or timer is in use. ON, OFF.	ON
8	Language	Language setting: English, (EN), French, (FR)	EN
9	Temperature Offset Note: Temperature offsets must always be entered as 2 digits. Example: 5° F is entered as 05.	Sets the temperature offset value for Bake, Convection Bake, Roast, and Convection Roast. When an offset value is entered, the actual oven temperature is increased or decreased by this value. This feature is useful if food is consistently either too brown or too light.  The range for changing the offset is between +/- 35° F (+/- 19° C) in 1° increments.  The default value is 0.	0

# Operation - Warming Drawer

## Turning Warming Drawer On and Off

1. Press the Warming Drawer touchpad.
2. WARMING DRAWER will be displayed with the default setting “MED”. The warming drawer amber icon is displayed below the clock.
3. To accept the “MED” setting, press the “Enter” touchpad on the numeric keypad. The setting is accepted and the warming drawer icon remains illuminated. If enter is not pressed, the warming drawer setting is not accepted and the warming drawer turns off.
4. To change the setting, when “MED” is displayed, press the warming drawer touchpad again. The setting changes to “HIGH”. Press the warming drawer touchpad again to change the setting to “LOW”. To accept a setting, press the Enter key on the numeric keypad. The displayed setting will be accepted and the warming drawer icon is illuminated below the clock, indicating that the warming drawer is active.
5. To turn the warming drawer off, press the warming drawer touchpad and the warming drawer will turn off and the warming drawer icon will no longer appear under the clock.

## Warming Empty Serving Bowls and Plates

- Use only heat-safe dishes.
- Warm on setting appropriate for cooking container.
- Check dish temperature during warming period.
- Place empty plates or dishes in a cold warming drawer. Do not preheat drawer prior to placing dishes.

# Getting the Most Out of Your Cooktop

## Cooktop Cooking Guide

### Boiling Water

Time to boil can vary greatly depending on environmental conditions. Try the following tips to decrease boil time:

- Use a lid.
- Use a pan that is appropriately sized for the amount of water and the size of the element.

- Select a pan with a flat base (See “Cookware Selection Guide” in the next column for details).
- Choose a medium-weight pan (rather than a heavyweight one).
- Make sure that the pan is positioned so that the entire base is in contact with the burner grate.
- Start with water that is already warm.
- Boil the smallest amount of water necessary. Smaller volumes will boil faster than larger volumes.

### Recommended Settings

Use this chart as a guide for heat settings. A range of heat settings are listed because the actual setting depends on:

- type and quality of pan (See “Cookware Selection Guide”),
- type, quantity and temperature of the food,
- element used and
- the cook’s preference

Uses	Heat Setting
Bringing water to a boil	High
Pan frying, sauteing, browning meat, deep fat frying	Medium High
Most frying, eggs, pancakes, slow boil	Medium
Finish cooking covered foods, steaming	Medium Low
Melting chocolate and butter, simmering tomato sauces, soups, stews	Low

## Cookware Selection Guide

### Cookware Characteristics

- Aluminum or copper bottomed pans conduct heat evenly.
- Steel pans, if not combined with other metals, may cook unevenly.
- Cast-iron cookware absorbs heat slowly and cooks more evenly at low-to-medium settings.
- Flat, heavy bottom pans provide even heat and stability.
- DO NOT USE pans that are thin, warped, dented or ridged as they heat unevenly.

**Tight Fitting Lids** – A lid shortens cooking/boiling time by holding heat inside the pot.

### Cookware Tips

- Use of pots and pans with rounded (either concave or convex) warped or dented bottoms should be avoided.
- Make sure the bottom of the pot or pan being used is clean and dry.
- Use pots and pans with thick, smooth metal bottoms

### Specialty Pans

<p>Pan Bottom Diameter</p> <ul style="list-style-type: none"><li>• The flame should be the same size as the bottom of the pan or smaller. Do not use small pans with high flame settings as the flames can lick up the sides of the pan.</li><li>• Oversize pans that span two burners are placed front to back, not side to side.</li><li>• For best cooking results, large pans should not extend over the sides of the grates</li></ul>	
<p>Use Balanced Pans</p> <ul style="list-style-type: none"><li>• Balance is important for stability and even cooking.</li><li>• Pans must sit level on the cooktop grate without rocking or wobbling.</li><li>• Center pan over burner</li></ul>	
<p>Use a Lid That Fits Properly</p> <p>A well-fitting lid helps shorten the cooking time</p>	

## Getting the Most Out of Your Oven

### Temperature Range by Cooking Mode

Mode	Lowest	Highest
Bake	100	550
Roast	100	550
Broil (Low, High)	450	550
Warm	150	225
Proof	85	125
Convection Bake	100	550
Convection Roast	100	550
Pizza	100	550

## Cooking Modes

### Bake

Bake is cooking with dry heated air. Heat comes from the lower burner and cycles to maintain the oven temperature. The Bake mode can be used to prepare a variety of food items, from pastries to casseroles. Refer to recipe or package directions for oven temperature and baking time.

### Tips

- When using the Bake mode, preheat the oven if the recipe recommends it.
- Baking time will vary with the size, shape and finish of the bakeware. Dark metal pans or nonstick coatings will cook faster with darker results. Insulated bakeware will lengthen the cook time for most foods.
- For best results, bake food on a single rack with at least 1 1/2" space between pans or dishes and oven walls.
- Eliminate heat loss from the oven by using the window to periodically check food for doneness instead of opening the door.
- If multiple racks are used, use a maximum of 2 racks. For cookies and cakes use positions 2 and 5. Stagger pans so that one is not directly above the other

### Convection Bake Convection

Bake is similar to Bake. Heat comes from the lower burner that is circulated throughout the oven by the convection fan. The Convection Bake mode is well suited for cakes, bar cookies and breads to take advantage of the bottom heat, yielding a better crust on baked items.

It is also best for baking cookies, biscuits, cream puffs, on multiple racks (2 or 3) at the same time.

The benefits of Convection Bake include:

- Slight decrease in cook time.
- Higher volume (yeast items rise higher).

### Tips

- Place food in shallow, uncovered pans such as cookie sheet without sides.
- For cakes and cookies use rack positions 3 and 5.
- If baking more than one pan on a rack, allow at least 1" to 1 1/2" of air space around the pan. Stagger pans so that one is not directly above the other (see graphic in next column).

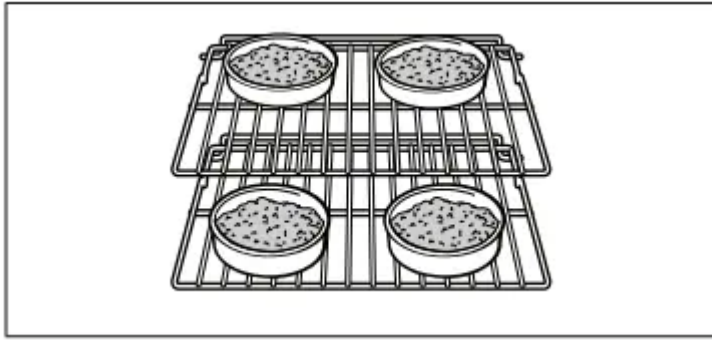

### **Auto Convection Conversion**

The Convection Bake mode requires a 25° F reduction in temperature. Auto Convection Conversion reduces the temperature you enter automatically. Simply enter the package or recipe temperature when setting the mode. The control calculates the correct temperature and it is shown in the display.

The Auto Convection Conversion feature can be turned on to allow for automatic temperature adjustments. See “Auto Convection Conversion” in “Settings” on page 19 for details.

### **Pizza**

In the Pizza mode, heat from the lower burner is circulated throughout the oven by the convection fan.

Use the Pizza mode for fresh or frozen pizza.

### **Tips**

- When baking a frozen pizza: For a crispy crust, place pizza directly on the rack. For a softer crust, use a pizza pan.
- When proofing pizza dough, coat dough with olive oil and cover it in a bowl tightly with plastic wrap to prevent crust formation.
- Sprinkle cornmeal on the pizza pan to prevent sticking.
- If using a pizza paddle, sprinkle the paddle liberally with cornmeal for ease in transferring the dough to the pan.
- If par baking handmade pizza dough, prick the dough with a fork before baking.
- If using a pizza pan, choose a dark, perforated pan for a more crisp crust and a non-perforated pan for a softer crust.
- Preheat baking stones following manufacturer’s recommendations while the oven is preheating.

- Bake homemade pizzas on rack position 2 in the center of the rack.
- Follow manufacturer's directions for frozen pizza.

## **Roast**

Roast uses the lower burner to maintain the oven temperature. Roast is best suited for meat and poultry and less tender cuts of meat.

### **Tips:**

- Preheating the oven is not necessary.
- Use a high-sided broil pan or roasting pan. Cover dish with a lid or foil for less tender cuts of meat.
- For less tender cuts of meat, add liquids such as water, juice, wine, bouillon or stock for flavor and moisture.
- Roasting bags and using a lid are suitable for use in this mode.
- When roasting whole chicken or turkey, tuck wings behind back and loosely tie legs with kitchen string

## **Broil**

Broil uses intense heat radiated from the upper burner. The Broil mode is best suited for cooking thin, tender cuts of meat (1" or less), poultry and fish. It can also be used to brown breads and casseroles. Always broil with the door closed. The benefits of broiling include:

- Fast and efficient cooking.
- Cooking without the addition of fats or liquids.

### **Tips:**

- Preheat oven 3–4 minutes. Do not preheat for more than 5 minutes.
- Steaks and chops should be at least  $\frac{3}{4}$ " thick.
- Brush fish and poultry with butter or oil to prevent sticking.
- Use a broil pan and grid, or a deep pan with a metal rack, for broiling.

## **Proof**

Proof is using the lower burner to maintain a low temperature to proof bread, pizza dough or other yeast doughs.

- No preheat is necessary.
- Proofing is the rising of yeast dough.
- The Proof Dough mode temperature range is 85° F to 125° F.
- The default temperature in the Proof Dough mode is 100° F.

- Loosely cover the bowl or pan and use any rack that accommodates the size of the container.
- Keep the oven door closed and use the oven light to check the rising of the dough. Warm Warm is cooking with dry, heated air. The lower burner cycles to maintain the oven temperature.
- Use the Warm mode to keep cooked foods hot until ready to serve for up to one hour.
- Warm mode temperatures are 150° F to 225° F.
- The default temperature in the Warm mode is 170° F.
- Foods that must be kept moist should be covered with a lid or aluminum foil.

## Getting the Most Out of Your Warming Drawer

### Temperature Recommendations

Food/Cookware	Setting	Cover Dish
Bacon	HIGH	No
Beef, medium and well done	MED	No
Beef, medium rare	LOW	No
Bread, hard rolls	MED	No
Bread, soft rolls, coffe cakes	MED	Yes
Biscuits	MED	Yes
Casseroles	MED	Yes
Eggs	MED	Yes
Fish, seafood	MED	Yes

Fried foods	HIGH	No
Gravy, cream sauces	MED	Yes
Ham	MED	Yes
Pancakes	HIGH	Yes
Pies, one crust	MED	Yes
Pies, two crusts	MED	No
Pizza	HIGH	No
Pork	MED	Yes
Potatoes, baked	HIGH	Yes

Potatoes, mashed	MED	Yes
Poultry, roasted	MED	Yes
Vegetables	MED	Yes
Plates	LOW	No
Plate of food	MED	Yes

# Cleaning and Maintenance

## Cooktop - Daily Cleaning

The entire Cooktop can be safely cleaned by wiping with a soapy sponge, then rinsing and drying. If stubborn soil remains, follow the recommended cleaning methods below.

- Always use the mildest cleaner that will do the job. Use clean, soft cloths, sponges or paper towels.
- Rub stainless steel finishes in the direction of the grain. Wipe area dry to avoid water marks.
- Before cleaning, be certain the burners are turned off and the grates and burners are cool.
- Do not clean removable cooktop parts in any selfcleaning oven.
- After cleaning, place all parts in their proper positions before using cooktop.
- For proper burner performance, keep igniters clean and dry
- Keep the ignitor ports clean for proper lighting performance of the burners. It is necessary to clean these when there is a boilover or when the burner does not light even though the electronic igniters click.
- Do not use flammable cleansers such as lighter fluid or WD-40.

## Cleaning Guidelines

### Cleaning the Oven

**To set the self-clean mode:**

1. Remove all accessories and racks from the oven.
2. If there is a cooking mode on, press **Oven Clear/Off** to end the running mode. If self-clean is set and the cooktop is turned on, the burner will light and "TURN OFF COOKTOP" flashes in the display. After a short time, "SELF CLEAN FINISHED" is displayed and the cooktop continues to operate.
3. Press the **Self Clean** touchpad below the display. The self-clean icon  appears in the display. The selfclean timer default (4:00) hours blinks to indicate it can be accepted or changed. To accept the 4:00 hour default self-clean time, press **Enter** on the numeric keypad.

To enter a different number of hours use the numeric keypad. The value entered must be within the range of 2:00 to 4:00 hours. Entering a value less than 2:00 or greater than 4:00 results in an error tone and message. Use a longer setting for a heavily soiled oven.



4. When the desired self-clean time is displayed, press **Enter** on the numeric keypad.

**The oven door locks prior to starting Self Clean.**

The door lock symbol  is displayed and blinks while the door is being locked. Once locked, the door lock symbol is continuously illuminated (not blinking).

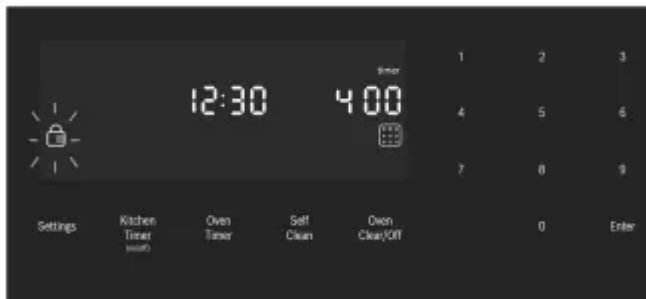

The door lock symbol remains illuminated as long as the self-clean mode is running.

**Note:** The door remains locked until the oven has cooled down after self-cleaning. The door can be opened again only after “Self Clean” disappears from the display.

5. **Self Clean** starts and the oven self-clean timer begins its countdown.

**To cancel Self Clean**

Press the Oven Clear/Off touchpad to cancel selfclean. When the self-clean timer ends, for safety the unit must cool down before the door can unlock. During this period the message “COOLING DOWN” is displayed.



6. When the cool down is complete, the message “SELF CLEAN FINISHED” is displayed. Continue to use caution when opening the oven door.





7. Press **Oven Clear/Off** to clear the display when selfclean is finished.

8. After the oven has cooled down and the door is unlocked, wipe remaining ash from the oven using a moist cloth.

### **Avoid These Cleaners**

Do not use commercial oven cleaners such as Easy Off®. They may damage the oven finish or parts. Chlorine or chlorine compounds in some cleansers are corrosive to stainless steel. Check ingredients on label. Never use scouring pads or abrasive cleaners.

## Oven Cleaning Guide



Part	Recommendations
Flat Rack	Wash with hot soapy water. Rinse thoroughly and dry, or gently rub with cleansing powder or soap-filled pads as directed. DO NOT clean the rack in the self-cleaning oven. If flat racks are cleaned in the oven during the self clean mode, they will loose their shiny finish and may not glide smoothly. If this happens wipe the rack edges with a small amount of vegetable oil. Then wipe off excess.
Telescopic Rack	Wash with soapy water. Rinse thoroughly and dry, or gently rub with cleansing powder or soap-filled pads as directed. Avoid getting cleansing powder in the telescopic slides. Relubrication may become necessary. Use only high-temperature foodgrade lubricants to re-lubricate slides. DO NOT clean the rack in the selfcleaning oven. DO NOT leave the rack in the oven during self clean. If the telescopic rack is cleaned in the oven during the self clean mode it will loose its shiny finish and will not glide smoothly.
Fiberglass Gasket	DO NOT CLEAN GASKET
Glass	Wash with soap and water or glass cleaner. Use Fantastik® or Formula 409® to remove grease splatters and stubborn stains
Painted Surfaces	Clean with hot soapy water or apply Fantastik® or Formula 409® to a clean sponge or paper towel and wipe clean. Avoid using powder cleaning agents, steel wool pads and oven cleaners.
Porcelain Surfaces	Immediately wipe up acid spills like fruit juice, milk and tomatoes with a dry cloth. Do not use a moistened sponge/cloth on hot porcelain. When cool, clean with hot soapy water or apply Bon-Ami® or Soft Scrub® to a damp sponge. Rinse and dry. For stubborn stains, use soap-filled pads. It is normal for porcelain to show fine lines with age due to exposure to heat and food soil.
Stainless Steel Surfaces	Never allow food stains or salt to remain on stainless steel for any length of time. Always wipe or rub in the direction of the grain. Clean with a soapy sponge, then rinse and dry, or wipe with Fantastik® or Formula 409® sprayed on a paper towel. Protect and polish with Stainless Steel Magic® and a soft cloth. Remove water spots with a cloth dampened with white vinegar. Use Bar Keeper's Friend® to remove heat discoloration. Chlorine or chlorine compounds in some cleansers are corrosive to stainless steel. Check ingredients on label.
Plastic & Controls	When cool, clean with soapy water, rinse and dry.
Probe	Wipe with soapy water. Do not submerge. Do not wash in the dishwasher.

Printed Areas (Words and Numbers)	Do not use abrasive cleansers.
---	--------------------------------

## Cleaning the Warming Drawer

Part	Recommendations
Drawer interior (polished stainless steel)	Use dish detergent. Wash, rinse well and dry. For hard water spots or scale, use white vinegar. Apply with a sponge or cloth, rinse, and dry
Painted surfaces	Use hot soapy water or mild cleaners such as Fantastik® or Formula 409® Wash, rinse well and dry. Avoid using abrasive cleaning agents, steel wool pads and oven cleaners
Drawer exterior frame (brushed stainless steel)	Always wipe or rub in the direction of the grain. Clean with a soapy sponge, then rinse and dry, or wipe with Fantastik® or Formula 409® sprayed on a paper towel. Protect and polish with Stainless Steel Magic® and a soft cloth. Remove water spots with a cloth dampened with white vinegar. Use Bar Keeper's Friend® to remove heat discoloration.

## Oven Maintenance

### Replacing an Oven Light

#### Bulb specifications:

Bulb Description	Bulb Image
40 watt, appliance bulb, standard Edison base	

To change the bulb:

1. Turn off power to the oven at the main power supply (fuse or breaker box).
2. Remove the glass cover by unscrewing it. Turn the glass counterclockwise to remove it.
3. Remove the bulb. The bulb unscrews counterclockwise.
4. Grasp the new bulb with a clean, dry cloth to prevent depositing skin oils on the glass which could lead to premature bulb failure. Replace the bulb by screwing it in turning the bulb clockwise.
5. Screw the glass cover back on.
6. Turn power back on at the main power supply (fuse or breaker box).

### Removing the Oven Door

To help avoid injury or damage be sure to read the above WARNING before attempting to remove the oven door.

1. Open the oven door to its fully open, horizontal position.
2. Flip levers on hinges toward you.

**Note:** It may be necessary to use a tool, such as a screwdriver, to gently pry the upper part of the lever away from the housing. Take care to avoid scratching the housing.

3. Bring both door hinge levers to their fullest down position as shown in the illustration. The left and right door hinge levers may differ slightly but operate in the same manner

4. Close the oven door until it catches on the hinge stop levers, locking the hinges at the proper angle for door removal. The door will be open about 7 inches at the top. This takes the spring tension off the hinges so the door can be easily lifted out.

5. The door is heavy. Use both hands to firmly grip it by the sides. Do not grip the door by the handle. Maintaining the door angle, lift the door straight up approximately 3/4" to unhook the hinges from the slots and then pull it out towards you until the hinges are clear of the oven housing. 6. Place the door in a convenient and stable location for cleaning.

### To replace the oven door

1. Holding the door firmly in both hands, grip it on either side, not by the handle.
2. Tilt the door back slightly towards you until it opens about 7" at the top.
3. Slide the hinges into the slots as far as they will go and then lower the door straight down. The angle of the door may need to be adjusted slightly to allow the hinges to engage properly and the door to lower into place. The door should lower about 3/4" and stop. If not, the hinges have not engaged properly and the door could fall if it is released.
4. Once both hinges are fully engaged as described in Step 3, gently open the door until it is fully open

5. Push the levers on both the hinges up and forward until they are locked into the slot, flush with the front of the oven body.
6. Close and open door slowly to be sure it is correctly and securely in place

### Removing the Drawer

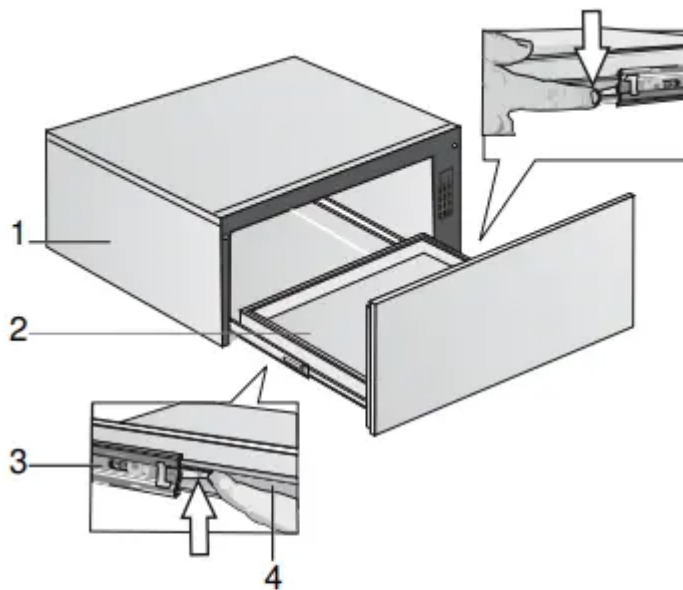

#### Parts

1	Housing
2	Drawer
3	Housing slide
4	Drawer rail

1. Pull drawer to fully open position.
2. Press down right drawer clip.
3. Lift up left drawer clip.

4. Firmly pull the drawer straight out. Retract housing slides while drawer is removed.

### **Replacing the Drawer**

1. Be sure housing slides are pushed inside housing.
2. Align the drawer rails with the housing slides attached to the drawer housing.
3. Firmly push the drawer straight into the drawer housing until the drawer clicks into place.

**Note:** The drawer has a “push-to-open” operation. Pressing the lower center front of the drawer causes the drawer to self-open.

4. Open and close drawer to test operation. Note: if the drawer will not close, verify that the rails on the drawer are properly aligned to housing slides and that the rail release levers are properly positioned.

## **Troubleshooting**

### **Cooktop Troubleshooting**

Cooktop Problem	Possible Causes and Suggested Solutions
Burner(s) do not light / Igniters do not spark	<ul style="list-style-type: none"> <li>• Make sure that the gas shut off valve is in the ON position and the gas supply to the house is not shut off.</li> <li>• Make sure the burner caps are properly positioned and the burner ports are not clogged. Clear ports with a wire or straightened paper clip if clogged.</li> <li>• Make sure the igniters are clean and dry.</li> <li>• Check the power supply. It should be properly grounded with the correct polarity. Make sure the unit is plugged in and the circuit breaker is not tripped.</li> </ul>
Burner flame goes out unexpectedly	<ul style="list-style-type: none"> <li>• Make sure that there is no draft in the room.</li> </ul>
Igniters spark even though knobs are in the off position	<ul style="list-style-type: none"> <li>• When the electrical power connection has been activated at the first power up or reconnected after an outage, the igniters may spark once or twice even though all burner knobs are in the off position.</li> </ul>
Cooking results are not what was expected	<ul style="list-style-type: none"> <li>• The cooktop is not level.</li> <li>• Cooking pan does not fit the surface being used.</li> <li>• Cookware is not the type or size recommended.</li> </ul>
Water takes too long to boil	<p>Time to boil can vary greatly depending on environmental conditions. See “Boiling Water” in this manual for tips to decrease time to boil.</p>

## Oven Troubleshooting



Oven Problem	Possible Causes and Suggested Solutions
The oven mode or temperature selected or the numbers selected do not appear in the display	Review manual instructions when setting clock, timer, or Self-Clean.
Oven door is locked and will not release, even after cooling	Turn the oven off at the circuit breaker and wait 5 minutes. Turn breaker back on. The oven should reset itself and will be operable
Oven is not heating	Be sure oven temperature has been selected. Check regulator switch as it may be off.
Oven is not cooking evenly	Adjust oven calibration if necessary (see “Change the Oven Temperature Offset” in this manual). Refer to cooking charts for recommended rack position.
Baking results are not as expected	Refer to cooking charts for recommended rack position. Check “Getting the Most Out of Your Oven” on page 24 for tips and suggestions. Adjust oven calibration if necessary (see “Change the Oven Temperature Offset” in this manual).
Food takes longer to cook than expected	The oven is carefully calibrated to provide accurate results. However, the temperature can be offset if food is consistently too brown or too light. See “Oven Temperature Offset” on page 19.
Food is overcooked	The oven is carefully calibrated to provide accurate results. However, the temperature can be offset if food is consistently too brown or too light. See “Oven Temperature Offset” on page 19.
Convection Bake Results are not as Expected	If the Automatic Convection Conversion Feature is turned off, the temperature must be manually reduced by 25° F. If the feature is active, the temperature is automatically adjusted. See “Turn Automatic Convection Conversion ON or OFF” for more information. Refer to cooking charts and tips for rack positions, cooking times and pan selection. Adjust oven calibration if necessary. See “Oven Temperature Offset” on page 19.
Oven temperature is too hot or too cold	The oven thermostat needs adjustment. See “Oven Temperature Offset” on page 19

Oven light is not working properly	Replace or reinsert the light bulb if loose or defective. Touching the bulb with fingers may cause the bulb to burn out.
Oven light will not turn off	Check for obstruction in oven door. Check to see if hinge is bent. When the Sabbath feature is activated, the oven light will stay on or off (as selected during set-up) during the entire Sabbath mode.
Cannot remove lens cover on light	There may be soil build-up around the lens cover. Wipe lens cover area with a clean dry towel prior to attempting to remove the lens cover
Oven will not Self-Clean properly	Allow the oven to cool before running Self-Clean. Always wipe out loose soils or heavy spillovers before running Self-Clean. If oven is badly soiled, set oven for a four-hour Self-Clean. See Preparing the Oven to Self-Clean
Clock and timer are not working properly	Make sure there is electrical power to oven. See Clock and Timer sections.
Porcelain chips	When oven racks are removed and replaced, always tilt racks upward and do not force them to avoid chipping the porcelain.
"E" and a number appears in display and control beeps	This is a fault code. Press Off to clear the display and stop beeping. Reset oven if necessary. If fault code remains and beep continues, record fault code, cancel oven and call authorized service technician.
With a new range there is a strong odor when oven is turned on	This is normal with a new range and will disappear after a few uses. Operating the self-clean cycle will also "burn-off" the smell more quickly
Control does not react when the pad is touched	Be sure that pad is clean. Touch the center of the touchpad. Use the flat part of your finger.
Fan is running during modes that don't use convection	On some models, the convection fan will run while the oven is preheating for the bake mode. This is normal. Slide-in models also have a cooling fan that runs during every cooking mode.
Warm air or steam escapes from oven vent	It is normal to see or feel steam or warm air escaping from the oven vent. Do not block the vent.
Cooling fan runs after oven is turned off (Slide-in ranges only)	This is normal. When the oven has cooled to a pre-determined temperature, the cooling fan turns off.

**Warning**

This content is compiled from multiple sources and is provided for reference purposes only. It may not be complete or fully applicable to all situations. If you are unable to resolve your issue, please contact the product manufacturer or an authorized service provider for official support.

---

Document generated by [ManualsFile](#)