

Operating Instructions

Controls

The controls will look like one of the following.

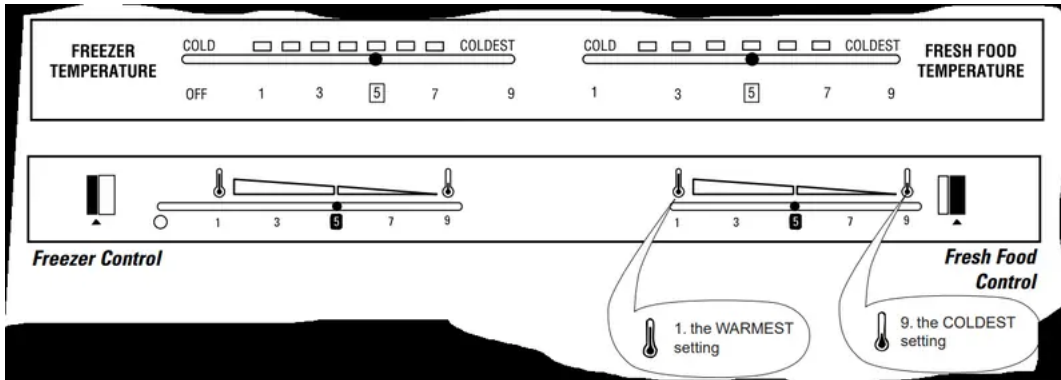

Initially, set the fresh food control at 5 and the freezer control at 5 and allow 24 hours for the temperature to stabilize.

Moving the freezer control to OFF or 0 stops cooling in both the fresh food and freezer compartments but does not shut off electrical power to the refrigerator.

Control settings will vary based on personal preferences, usage, and operating conditions and may require more than one adjustment.

Testing and Adjusting Temperatures

Several adjustments may be required. Each time you adjust controls, allow 24 hours for the refrigerator to reach the temperature you have set.

- The freezer supplies cold air for both compartments
- The freezer setting determines the compressor and freezer fan run times.
- The fresh food control maintains the temperature in the fresh food compartment by controlling the amount of cold air that flows from the freezer to the fresh food side.
- Both temperature controls may need adjustment to get the desired temperature in the fresh food compartment.



To test the freezer, place ice cream in the center of the freezer. Check it after 24 hours.

If it's too hard or too soft, adjust the setting.









To test the fresh food compartment, place a beverage on the top shelf. After 24 hours, taste the drink. If the temperature is not satisfactory, adjust the setting.

On some models. The controls will look like one of the following.

The Electronic Monitor and Diagnostic System controls dispenser functions and monitors the operation of your refrigerator.



Monitor and Diagnostic System

1. **NORMAL** ✓ lights up to indicate that no failure has been detected by the diagnostic system.
2. **DOOR OPEN**  flashes when either door is open.
3. **WARMTEMP**  lights up when freezer food-keeping temperature is above normal.
4. **Flashing diagnostic codes.** What these codes mean—and what to do when they appear—is explained more thoroughly on the following pages.
5. **SYSTEM CHECK-RESET**  reviews the diagnosis of four coded functions and allows you to erase codes from the display.
6. Select **CUBED ICE** , **CRUSHED ICE**  or **WATER**  and the signal light confirms your choice.
7. **DOOR ALARM**  lights up when the beeper has been set to sound after either door has been open 30 seconds.

When Your Refrigerator Is First Plugged In

All panel lights come on for five seconds, a beep sounds, and lights go off except as follows:

- **PF** flashes in the display. Touch **SYSTEM CHECK-RESET** to erase it.
- **NORMAL** glows.
- **WARM TEMP** glows until the refrigerator cools down. It goes off when proper foodkeeping temperature is reached.
- Door alarm beeper is activated and **DOOR ALARM** glows.
- **CRUSHED ICE** glows.
- **DOOR OPEN** flashes if either door is open, goes out when doors are shut.
- Night light in ice and water dispenser is off.



How to Set the Door Alarm

To set the alarm press **DOORALARM** until it glows.

The control beeps if either door is open for more than 30 seconds.

The light goes out and the beeping stops when you close the door.



Why the WARM TEMP Light Glows

At first, it's probably because your newly installed refrigerator hasn't completely cooled down yet. Wait a few hours for it to cool, and then the light will go out.

From then on, WARM TEMP will glow whenever temperatures inside get too high for proper food storage. If this happens, open the doors only when absolutely necessary, and close them as quickly as possible.

As soon as inside temperatures return to normal, the light goes out.

If WARM TEMP reappears and stays on for longer than 4 hours, call for service.

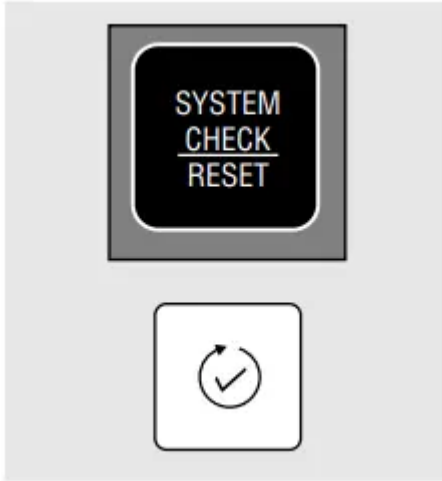

How the Monitor and Diagnostic System Works

The diagnostic code flashes and the control beeps when something starts to go wrong.

If more than one coded function requires attention at the same time, the one with the highest priority will be displayed first.

Pressing **SYSTEM CHECK-RESET** will erase two codes immediately—**PF** and **CI**. The **dE** and **FF** codes can only be erased by pressing **SYSTEM CHECK-RESET** after the condition that caused the code to flash has been corrected.

SYSTEM CHECK-RESET will also evaluate all other coded functions. If **NORMAL** is lit during the displaying of a code, that function is operating properly.



What the Codes Mean

Check your frozen food. Has any of it started to thaw? A package may be holding the freezer compartment door open. Don't open the door more often than absolutely necessary while this code

is displayed. Touching *SYSTEM CHECK-RESET* after the freezer compartment temperature has returned to normal will erase the code.



Power to the refrigerator has been interrupted for more than two seconds. Check the condition of food in both the fresh food and freezer compartments. Touch *SYSTEM CHECK-RESET* to erase the code. There is no fault with the refrigerator when the PF code flashes.



Check the icemaker. Ice clumps in the storage bin may have stalled the icemaker. Follow corrective measures described in *Troubleshooting Tips*. If water supply to the icemaker is not connected or not turned on, make sure the icemaker feeler arm is in the STOP (up) position. The code stops flashing when problem is corrected or *SYSTEM CHECK-RESET* is touched.



Something is wrong with the defrost system—keep doors closed to retain cold and call for service. The code flashes until problem is corrected.

Water filter cartridge.

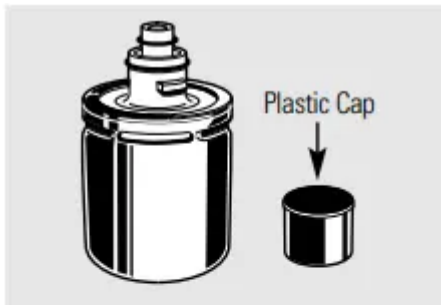

Discard the plastic cap.

REPLACE FILTER BY:

(month-year)

replace every 6 months

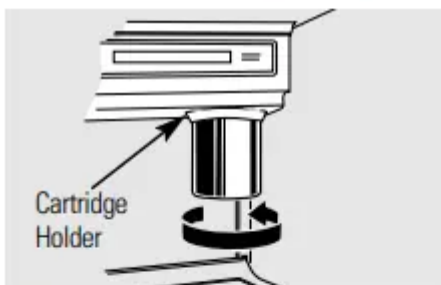

Place the top of the cartridge up inside the cartridge holder and slowly turn it to the right.

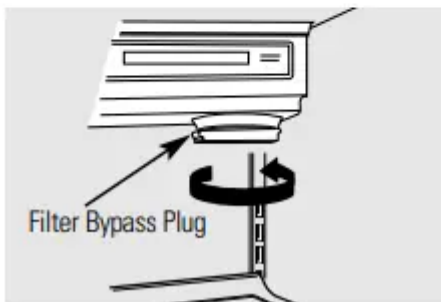

The water filter cartridge is located in the upper right-hand corner of the fresh food compartment, right below the temperature controls.

The filter cartridge should be replaced every **six months** or earlier if the flow of water to the water dispenser or icemaker decreases.

Installing the Filter Cartridge

1. If you are replacing the cartridge, first remove the old one by slowly turning it to the left.
Do not pull down on the cartridge. A small amount of water may drip down.
2. Remove and discard the plastic cap from the new cartridge.

3. Fill the replacement cartridge with water from the tap.
4. Apply the month and year sticker to the cartridge to remind you to replace the filter in **six months**.
5. Place the top of the cartridge up inside the cartridge holder. **Do not** push it up into the holder.
6. Slowly turn it to the right until the filter cartridge stops. **DONOTOVERTIGHTEN**. As you turn the cartridge, it will automatically raise itself into position.
7. Run water from the dispenser for 1 minute (about a half gallon) to clear the system and prevent sputtering.

NOTE: A newly-installed water filter cartridge may **cause water to spurt** from the dispenser.

Filter Bypass Plug

You must use the filter bypass plug when a replacement filter cartridge is not available. The dispenser and the icemaker will not operate without the filter or filter bypass plug.

Questions?...In the United States, call the GE Answer Center® 800.626.2000.

Replacement Filters:

To order additional filter cartridges in the United States, call GE Parts and Accessories, 800-626-2002.

FXRT—Chlorine, Taste and Odor Suggested Retail \$29.95 FXRC—Chlorine, Taste and Odor—Lead and Cysts Suggested Retail \$34.95

Customers in Canada should consult the yellow pages for the nearest Camco Service Center.

Shelves and baskets.

Rearranging the Shelves and Freezer Baskets

Glass and wire shelves are adjustable.



To Remove



To Replace

Wire slide-out freezer baskets can be relocated in the same way



Slide-Out Spillproof Shelf (on some models)



The slide-out spillproof shelf allows you to reach items stored behind others. The special edges are designed to help prevent spills from dripping to lower shelves. Make sure you push the shelves all the way back in before you close the door.

Quick Space Shelf



This shelf splits in half and slides under itself for storage of tall items on the shelf below.

Removable Wine Rack



The wine rack is designed to hold a bottle on its side. A good location for the wine rack is the quick space shelf.

SpaceSaver™ Rack

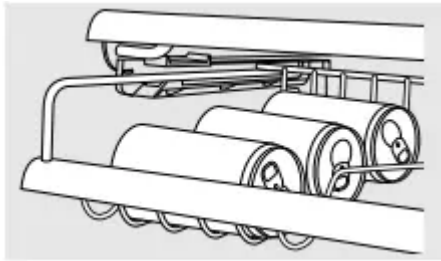

Use this rack to store beverage cans for easy access. It can also hold a 9" x 13" baking dish.

Refrigerator bins and dishes.

Bins on the Fresh Food Compartment Door

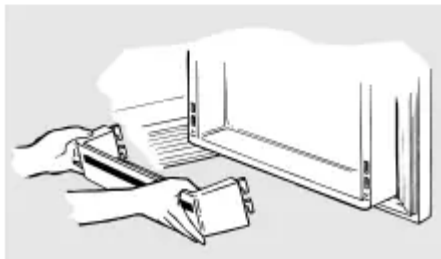
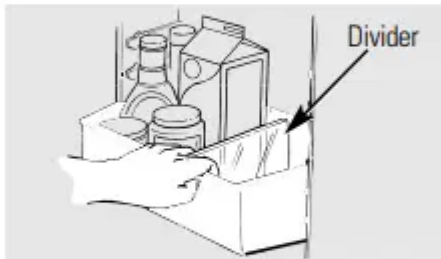
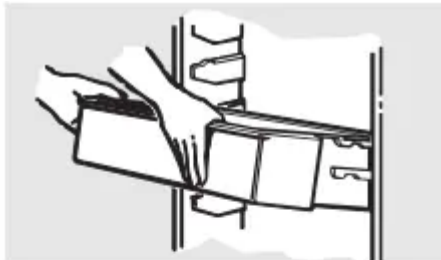

Adjustable bins can easily be carried from refrigerator to work area.

To remove: Tilt the bin up and pull out on the molded supports until it comes completely out of the door.

To replace or relocate: Select desired shelf height, engage the bin in the molded supports of the door and slide the bin in. The bin will hook in place.

The divider helps prevent tipping, spilling or sliding of small items stored on the door shelf. Place a finger on either side of the divider near the front and move it back and forth to fit your needs.

To remove fixed bins, first remove the food in the bins. Then, grasping the bin at each end, push in at the bottom as you lift and pull out at the top.

Quick Serve™ System



CAUTION: Dishes and lids are not designed for use on the range top, broiler or in the regular oven. Such use can be hazardous.

Quick Serve™ dishes fit into a space-saving rack under the shelf. The rack can be relocated anywhere in the fresh food compartment.

Dishes and lids are safe for use in microwave ovens, refrigerators and freezers.

Do not use when cooking high-fat foods, such as bacon, and high-sugar foods, such as candy and syrup. The high temperatures of the fat and sugar can cause bubbles to form on the inside of the dish.

Storage drawers

Storage Drawers



Excess water that may accumulate in the bottom of the drawers should be emptied and the drawers wiped dry

Adjustable Humidity Drawers



Slide the control all the way to the  setting to provide high humidity recommended for most vegetables. Slide the control all the way to the  setting to provide lower humidity levels recommended for most fruits.

Convertible Meat Drawer



The convertible meat drawer has its own cold air duct to allow a stream of cold air from the freezer compartment to flow around the drawer.

The variable temperature control regulates the air flow from the freezer compartment.

Set control lever down to the coldest setting to store fresh meats. If lever is left in meat position for a long period of time, some frost may form on the inside of the drawer.

Set control lever up to convert the drawer to normal refrigerator temperature and provide extra vegetable storage space. Cold air duct is turned off. Variable settings between these extremes can be selected

Storage drawer removal

Drawer Removal



When replacing the drawers, make sure you slide them through both drawer guides on the right side.



Drawers can easily be removed by tilting up slightly and pulling past the stop location.

Remove the door bins from the fresh food door before removing the drawer.

To remove the shelf above the top drawer, first remove the top drawer and any food on the shelf. Then tilt the shelf up at the front and lift it up and out of the tracks.

To replace the shelf, raise the shelf front slightly and place the top hooks in the lowest large track slots. Then lower the front of the shelf until it is level.

To remove the drawers when the fresh food compartment door cannot be opened fully you need to roll the refrigerator forward until the door can be fully opened. In some cases this will require moving the refrigerator to the left as you roll it out

Refrigerator doors

Refrigerator Doors

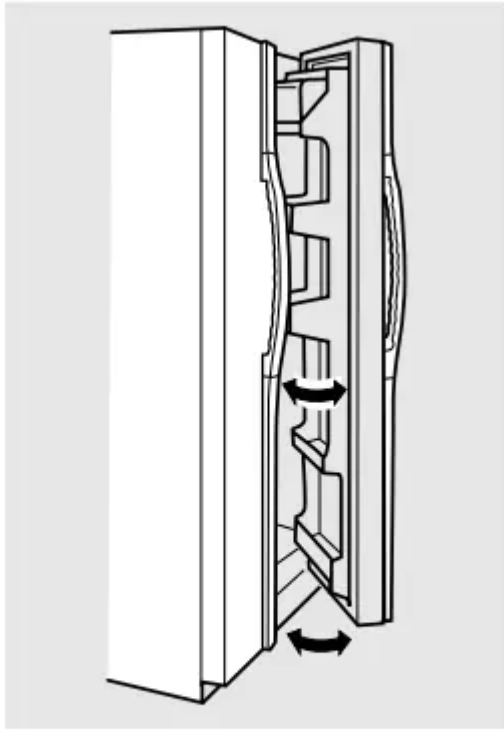

When the door is only partially open it will automatically close.

*Beyond this **stop** the door will stay open.*

The refrigerator doors may feel different than the ones you are used to. The special door opening/closing feature makes sure the doors close all the way and are securely sealed.

When opening and closing the door you will notice a stop position. If the door is opened past this stop point, the door will remain open to allow you to load and unload food more easily. When the door is only partially open it will automatically close.

The resistance you feel at the stop position will be reduced as the door is loaded with food.

Refreshment center

The Refreshment Center Compartment stores frequently used items.

When open, the Refreshment Center door provides a convenient work surface. Although durable, the work surface should not be used as a cutting board. Close the door when finished. The upper fresh food compartment light will come on when the Refreshment Center door is opened.



The special design of the door allows you to tilt and lift up the door in order to clean the bottom of the frame.

NOTE: Use caution in closing or using the clean-out feature in the presence of small children.



Cold air entering from the freezer compartment keeps the temperature in the Refreshment Center Compartment at proper food-keeping levels. The bin panel limits the amount of cold air that escapes when the Refreshment Center door is opened. To reach food from the inside, lift the panel up.



To remove the Refreshment Center bin, first remove the panel using the hand holds.



Then remove the bin by lifting it up and out.

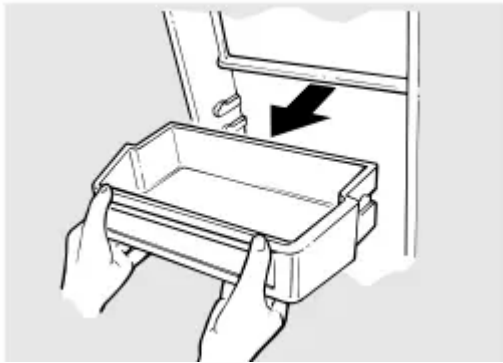

Automatic icemaker

A newly-installed refrigerator may take 8 to 12 hours to begin making ice.



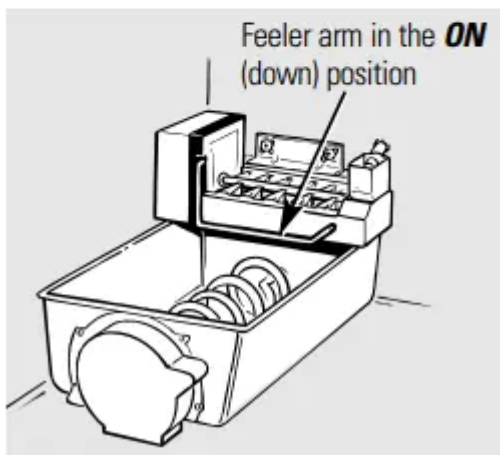
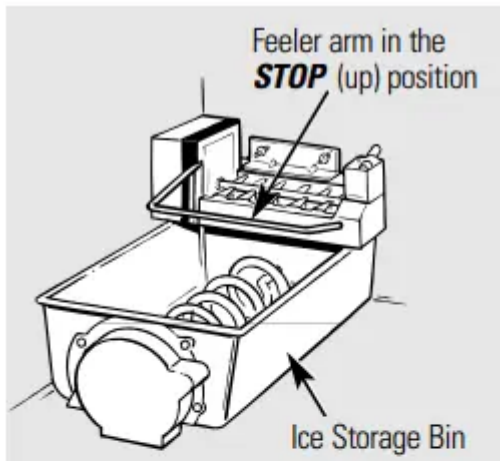

The icemaker will produce eight cubes per cycle—approximately 120 cubes in a 24-hour period, depending on freezer compartment temperature, room temperature, number of door openings and other use conditions.

If the refrigerator is operated before the water connection is made to the icemaker, keep the feeler arm in the STOP (up) position.

When the refrigerator has been connected to the water supply, move the feeler arm to the ON (down) position.

The icemaker will fill with water when it cools to freezing. A newly-installed refrigerator may take 8 to 12 hours to begin making ice cubes.

Throw away the first few batches of ice to allow the water line to clear.

Be sure nothing interferes with the swing of the feeler arm.

It is normal for several cubes to be joined together.

If ice is not used frequently, old ice cubes will become cloudy and taste stale.

Ice and water dispenser

To Use the Dispenser



Press the rim of the glass gently against the dispenser pad.

Select **CUBED ICE** , **CRUSHED ICE**  or **WATER** .

The spill shelf is not self-draining. To reduce water spotting, the shelf and its grille should be cleaned regularly.

If no water is dispensed when the refrigerator is first installed, there may be air in the water line system. Press the dispenser pad for at least two minutes to remove trapped air from the water line and to fill the water system. To flush out impurities in the water line, throw away the first six glassfuls of water.

A light switch (on some models) turns the night light in the dispenser on or off. The light also comes on when the dispenser pad is pressed. The light in the dispenser should be replaced with a 7 watt maximum bulb when it burns out.

Ice Storage Bin



To remove:

Lift the left corner to free the bin from the shelf and pull the bin straight out while supporting it at front and rear.

To replace:

Slide the bin back until the tab on the bin locks into the slot on the shelf. If the bin does not go all the way back, remove it and rotate the drive mechanism 1/4 turn. Then push the bin back again until the tab on the bin locks into the slot on the shelf.



Important Facts About Your Dispenser

- Add ice before filling the glass with a beverage.
- Do not add ice from trays or bags to the storage bin. It may not crush or dispense well.
- Avoid overfilling glass with ice and use of narrow or extra-tall glasses. Backed-up ice can jam the chute or cause the door in the chute to freeze shut. If ice is blocking the chute, poke it through with a wooden spoon.
- Beverages and foods should not be quick-chilled in the ice storage bin. Cans, bottles or food packages in the storage bin may cause the icemaker or auger to jam.
- Some crushed ice may be dispensed even though you selected **CUBED ICE**. This happens occasionally when a few cubes accidentally get directed to the crusher.
- After crushed ice is dispensed, some water may drip from the chute.
- Sometimes a mound of snow will form on the door in the ice chute. This condition is normal and usually occurs when you have dispensed crushed ice repeatedly. The snow will eventually evaporate.
- Dispensed water is not ice cold. For colder water, add crushed ice or cubes before dispensing water.

Care and cleaning of the refrigerator.

Cleaning the Outside





Refreshment Center Compartment door— outside. It's important that you use only window cleaner without ammonia or a damp cloth to clean the glass and trim. Avoid using wax on the Refreshment Center door.

The dispenser well, beneath the grille, should be wiped dry. Water left in the well may leave deposits. Remove the deposits by adding undiluted vinegar to the well. Soak until the deposits disappear or become loose enough to rinse away.

The dispenser pad. Clean with warm water and baking soda solution—about a tablespoon (15 ml) of baking soda to a quart (1 l) of water. Rinse thoroughly and wipe dry.

HINT: *Open the freezer door part way to prevent dispensing of ice or water when cleaning.*

The door handles and trim. Clean with a cloth dampened with soapy water. Dry with a soft cloth.

The stainless steel panels and door handles (on some models) can be cleaned with a commercially available stainless steel cleaner using a clean, soft cloth.

Keep the outside clean. Wipe with a clean cloth lightly dampened with kitchen appliance wax or mild liquid dish detergent. Dry and polish with a clean, soft cloth.

Do not wipe the refrigerator with a soiled dish cloth or wet towel. These may leave a residue that can erode the paint. Do not use scouring pads, powdered cleaners, bleach or cleaners containing bleach because these products can scratch and weaken the paint finish.

Cleaning the Decorator Door Panels

Clean these panels using an anti-static cleaner or a mild detergent and water.

(Look for anti-static cleaner in electronic or computer departments.) Rinse thoroughly and blot dry with a clean, damp cloth or chamois. Do not use paper towels to wash or dry the panels. Do not use cleaners that contain solvents, such as ammonia, because they can damage the panels.

Shallow scratches and abrasions can be corrected with a good grade of hard automobile paste wax. The wax will fill in any minor surface scratches and will help to maintain the luster of the panels. Apply the wax sparingly and buff lightly with a clean, soft cloth using a circular motion. Do not use a cleaner/wax combination.

Cleaning the Inside



To help prevent odors, leave an open box of baking soda in the fresh food and freezer compartments.

Unplug the refrigerator before cleaning. If this is not practical, wring excess moisture out of sponge or cloth when cleaning around switches, lights or controls.

Use warm water and baking soda solution— about a tablespoon (15 ml) of baking soda to a quart (1 l) of water. This both cleans and neutralizes odors. Rinse and wipe dry.

Door magnets can be cleaned the same way.

Refreshment Center Compartment door—inside. Wipe up spills right away. Use one tablespoon (15 ml) of baking soda in one quart (1 l) of water to clean the inside door surface, Refreshment Center bin and inside access door. Rinse, wipe dry.

Avoid cleaning cold glass shelves (on some models) with hot water because the extreme temperature difference may cause them to break. Handle glass shelves carefully. Bumping tempered glass can cause it to shatter.

*Do not wash any plastic refrigerator parts in the dishwasher **except Quick Serve dishes and lids.***

Behind the Refrigerator

Be careful when moving the refrigerator away from the wall. All types of floor coverings can be damaged, particularly cushioned coverings and those with embossed surfaces.

Pull the refrigerator straight out and return it to position by pushing it straight in. Moving the refrigerator in a side direction may result in damage to the floor covering or refrigerator.

When pushing the refrigerator back, make sure you don't roll over the power cord or icemaker supply line.

Under the Refrigerator



Clean the condenser coils at least once a year.



For most efficient operation, keep the area under the refrigerator clean. Remove the base grille and sweep away or vacuum up dust.

For best results, use a brush specially designed for this purpose. It is available at most appliance parts stores.

To remove the base grille, open both doors, grasp the bottom of the grille and pull it out.

To replace the base grille, line up the clips on the back of the grille with the openings in the baseplate and push the grille forward until it snaps into place.

Preparing for Vacation

For long vacations or absences, remove food and unplug the refrigerator. Move the freezer control to the **OFF** or  position, and clean the interior with a baking soda solution of one tablespoon (15 ml) of baking soda to one quart (1 L) of water. Leave the doors open.

Move the icemaker feeler arm to the **STOP** (up) position and shut off the water supply to the refrigerator.

When you return from vacation, select **WATER** on the dispenser and press the dispenser pad for at least two minutes to remove stale water from the water system.

If the temperature can drop below freezing, have a qualified servicer drain the water supply system to prevent serious property damage due to flooding.

Preparing to Move

Secure all loose items such as grille, shelves and drawers by taping them securely in place to prevent damage.

Be sure the refrigerator stays in an upright position during moving.

Replacing the light bulbs

Turning the control to the OFF or  position does not remove power to the light circuit

Fresh Food Compartment—Upper Light

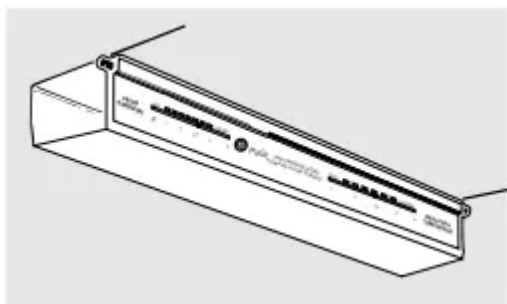

1. Unplug the refrigerator.
2. To align the control knobs properly, note position of each knob for proper reassembly, move both knobs all the way to the left, then pull them off.
3. To remove the light shield, pull it straight out.

After replacing with an appliance bulb of the same or lower wattage, reinstall the light shield. Replace the control knobs, move them to their previous settings and plug the refrigerator back in

Fresh Food Compartment—Two Lower Lights (on some models)

These lights are located behind the top drawer.

Unplug the refrigerator and remove the top drawer and cover.

Grasp the bottom of the light shield and pull it forward and up to free its bottom edge.

After replacing with an appliance bulb of the same or lower wattage, reinstall the light shield, drawer and cover and plug the refrigerator back in.

Freezer Compartment—Non-Dispenser Models

1. Unplug the refrigerator.
2. Remove the shelf just below light shield.
3. Pull the plastic light shield, which is underneath the ice compartment, toward you.

After replacing with an appliance bulb of the same or lower wattage, reinstall the shield and shelf, and plug the refrigerator back in.

Freezer Compartment—Dispenser Models

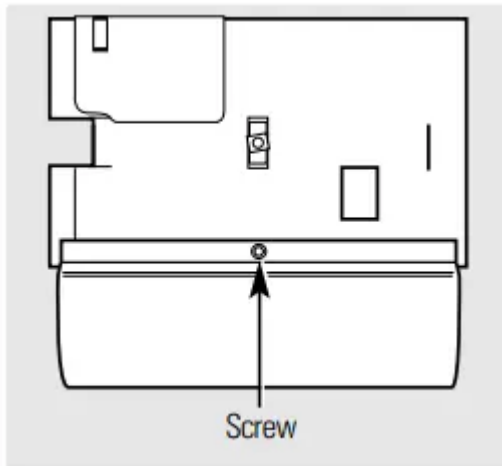

1. Unplug the refrigerator.
2. Remove the ice storage bin.
3. Remove screw at top of light shield.

After replacing with an appliance bulb of the same or lower wattage, reinstall the shield and ice storage bin, and plug the refrigerator back in.

Troubleshooting Tip

Normal operating sounds

Depending on the placement of the refrigerator in your kitchen, you may want to place a piece of rubber-backed carpet under the refrigerator to reduce noise.



Icemaker

The icemaker water valve will buzz when the icemaker fills with water. If the feeler arm is in the ON (down) position it will buzz even if it has not yet been hooked up to water. Keeping the feeler arm in the ON (down) position before it is hooked up to water can damage the icemaker. To prevent this, raise the feeler arm to the STOP (up) position. This will stop the buzzing. The sound of cubes dropping into the bin and water running in pipes as icemaker refills.

Before you call for service...

| <i>Problem</i> | <i>Possible Causes</i> | <i>What To Do</i> |
|--|---|--|
| <i>Refrigerator does not operate</i> | Refrigerator in defrost cycle. | <ul style="list-style-type: none"> • Wait about 30 minutes for defrost cycle to complete. |
| | Freezer control in <i>OFF</i> or  position. | <ul style="list-style-type: none"> • Move the freezer control to a temperature setting. |
| | Refrigerator is unplugged. | <ul style="list-style-type: none"> • Push the plug completely into the outlet. |
| | The fuse is blown/circuit breaker is tripped. | <ul style="list-style-type: none"> • Replace fuse or reset the breaker. |
| <i>Vibration or rattling (slight vibration is normal)</i> | Rollers need adjusting. | <ul style="list-style-type: none"> • See <i>Leveling Rollers</i>. |

| | | |
|--|---|---|
| <p>Motor operates for long periods or cycles on and off frequently. (Modern refrigerators with more storage space and a larger freezer require more operating time. They start and stop often to maintain even temperatures.)</p> | <p>Normal when refrigerator is first plugged in.</p> | <ul style="list-style-type: none"> • Wait 24 hours for the refrigerator to completely cool down. |
| | <p>Often occurs when large amounts of food are placed in refrigerator.</p> | <ul style="list-style-type: none"> • This is normal. |
| | <p>Door left open.</p> | <ul style="list-style-type: none"> • Check to see if package is holding door open. |
| | <p>Hot weather or frequent door openings.</p> | <ul style="list-style-type: none"> • This is normal. |
| | <p>Temperature controls set at the coldest setting.</p> | <ul style="list-style-type: none"> • See <i>About the controls</i>. |
| | <p>Grille and condenser need cleaning.</p> | <ul style="list-style-type: none"> • See <i>Care and cleaning</i>. |
| <p>Fresh food or freezer compartment too warm</p> | <p>Temperature control not set cold enough.</p> | <ul style="list-style-type: none"> • See <i>About the controls</i>. |
| | <p>Warm weather or frequent door openings.</p> | <ul style="list-style-type: none"> • Set the temperature control one step colder. See <i>About the controls</i>. |
| | <p>Door left open.</p> | <ul style="list-style-type: none"> • Check to see if package is holding door open. |
| <p>Frost or ice crystals on frozen food (frost within package is normal)</p> | <p>Door left open.</p> | <ul style="list-style-type: none"> • Check to see if package is holding door open. |
| | <p>Too frequent or too long door openings.</p> | |

| | | |
|--|---|---|
| <i>Divider between fresh food and freezer compartments feels warm</i> | Automatic energy saver system circulates warm liquid around front edge of freezer compartment. | <ul style="list-style-type: none"> • This helps prevent condensation on the or |
| <i>Automatic icemaker does not work</i> | Icemaker feeler arm in the <i>STOP</i> (up) position. | <ul style="list-style-type: none"> • Move the feeler arm to the ON (down) position. • Cubes may have fused to the side of the r Move the feeler arm to the STOP (up) position remove these cubes. |
| | Water supply turned off or not connected. | <ul style="list-style-type: none"> • See <i>Installing the water line</i>. |
| | Freezer compartment too warm. | <ul style="list-style-type: none"> • Wait 24 hours for the refrigerator to come cool down. |
| | Piled up cubes in the storage bin cause the icemaker to shut off. | <ul style="list-style-type: none"> • Level cubes by hand. |
| <i>Ice cubes have odor/ taste</i> | Ice storage bin needs cleaning. | <ul style="list-style-type: none"> • Empty and wash bin. Discard old cubes. |
| | Food transmitting odor/ taste to ice cubes. | <ul style="list-style-type: none"> • Wrap foods well. |
| | Interior of refrigerator needs cleaning. | <ul style="list-style-type: none"> • See <i>Care and cleaning</i>. |
| <i>Small or hollow cubes</i> | Water filter clogged. | <ul style="list-style-type: none"> • Replace filter cartridge with new cartridge plug. |
| <i>Slow ice cube freezing</i> | Door left open. | <ul style="list-style-type: none"> • Check to see if package is holding door open |

| | | |
|--|---|--|
| | Temperature control not set cold enough. | <ul style="list-style-type: none">• See <i>About the controls</i>. |
| <i>Orange glow in the freezer</i> | Defrost heater is on. | <ul style="list-style-type: none">• This is normal. |



| | | |
|--|---|---|
| <i>Cube dispenser does not work</i> | Icemaker turned off or water supply turned off. | <ul style="list-style-type: none"> • Turn on icemaker or water supply. |
| | Ice cubes are frozen to icemaker feeler arm. | <ul style="list-style-type: none"> • Remove cubes and move the feeler arm ON (down) position. |
| | Irregular ice clumps in storage container. | <ul style="list-style-type: none"> • Break up with fingertip pressure and discard remaining clumps. • Freezer may be too warm. Adjust the freezer control to a colder setting, one position at a time until clumps do not form. |
| <i>Water has poor taste/odor</i> | Water dispenser has not been used for a long time. | <ul style="list-style-type: none"> • Dispense water until all water in system is replenished. |
| <i>Water dispenser does not work</i> | Water supply line turned off or not connected. | <ul style="list-style-type: none"> • See <i>Installing the water line</i>. |
| | Water filter clogged. | <ul style="list-style-type: none"> • Replace filter cartridge or remove filter and clean plug. |
| | Air may be trapped in the water system. | <ul style="list-style-type: none"> • Press the dispenser pad for at least two minutes. |
| <i>Water spurting from dispenser</i> | Newly-installed filter cartridge. | <ul style="list-style-type: none"> • Run water from the dispenser for 1 minute (about a half gallon). |
| <i>Water is not dispensed but icemaker is working</i> | Water in reservoir is frozen. | <ul style="list-style-type: none"> • Call for service. |
| <i>No water or ice cube production</i> | Supply line or shutoff valve is clogged. | <ul style="list-style-type: none"> • Call a plumber. |
| | Water filter clogged. | <ul style="list-style-type: none"> • Replace filter cartridge or remove filter and clean plug. |

| | | |
|---|--|---|
| <i>Refrigerator has odor</i> | Foods transmitting odor to refrigerator. | <ul style="list-style-type: none"> • Foods with strong odors should be tightly • Keep an open box of baking soda in the refrigerator; replace every three months. |
| | Interior needs cleaning. | <ul style="list-style-type: none"> • See <i>Care and cleaning</i>. |
| <i>Moisture forms on outside of refrigerator</i> | Not unusual during periods of high humidity. | <ul style="list-style-type: none"> • Wipe surface dry. |
| <i>Moisture collects inside (in humid weather, air carries moisture into refrigerator when doors are opened)</i> | Too frequent or too long door openings. | |
| <i>Interior light does not work</i> | No power at outlet. | <ul style="list-style-type: none"> • Replace fuse or reset the breaker. |
| | Light bulb burned out. | <ul style="list-style-type: none"> • See <i>Replacing the light bulbs</i>. |
| <i>Water on kitchen floor or on bottom of freezer</i> | Cubes jammed in chute. | <ul style="list-style-type: none"> • Poke ice through with a wooden spoon. |
| <i>No panel touch pad response</i> | If interior light is not on, refrigerator may not be plugged in at wall outlet. | <ul style="list-style-type: none"> • Make sure refrigerator is securely plugged wall outlet. |
| | Tripped circuit breaker or burned-out fuse. | <ul style="list-style-type: none"> • Replace fuse or reset the breaker. |
| <i>Door not closing properly or only partially closing</i> | The doors are designed to stay open partway for ease of loading food. | |

| | | |
|---|--|---|
| <i>Hot air from bottom of refrigerator</i> | Normal air flow cooling motor. In the refrigeration process, it is normal that heat be expelled in the area under the refrigerator. Some floor coverings will discolor at these normal and safe temperatures. | <ul style="list-style-type: none">• Your floor covering supplier should be consulted if you object to this discoloration. |
|---|--|---|

Warning

This content is compiled from multiple sources and is provided for reference purposes only. It may not be complete or fully applicable to all situations. If you are unable to resolve your issue, please contact the product manufacturer or an authorized service provider for official support.

