

PRODUCT OVERVIEW

Parts

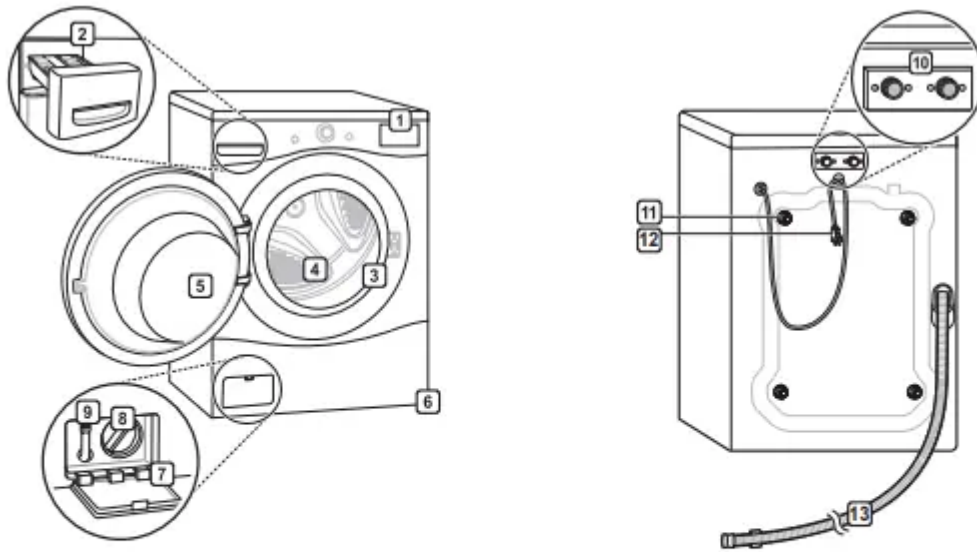

- | | | | |
|-------------------------------------|------------------------|----------------------------------|--------------------------|
| 1 Control Panel | 4 Drum | 7 Drain Pump Filter Cover | 10 Water Inlets |
| 2 Detergent Dispenser Drawer | 5 Door | 8 Drain Pump Filter | 11 Shipping Bolts |
| 3 Door Seal | 6 Leveling Feet | 9 Drain Hose | 12 Power Cord |
| | | | 13 Drain Hose |

Accessories

Included Accessories



Non-skid pads



Hole caps (4)



Wrench



Tie strap



Elbow bracket
(for securing drain hose)

Required Accessories



Hot/cold water hoses
(sold separately)

Optional Accessories



Pedestal or Pedestal washer
(sold separately)



Stacking Kit
(sold separately)

NOTE

- The images in this guide may be different from the actual components and accessories, which are subject to change by the manufacturer without prior notice for product improvement purposes.
- For your safety and for extended product life, use only authorized components. The manufacturer is not responsible for product malfunction or accidents caused by the use of separately purchased unauthorized components or parts.

INSTALLATION

Tools Needed



Pliers



Level

Installation Overview

Please read the following installation instructions first after purchasing this product or transporting it to another location.

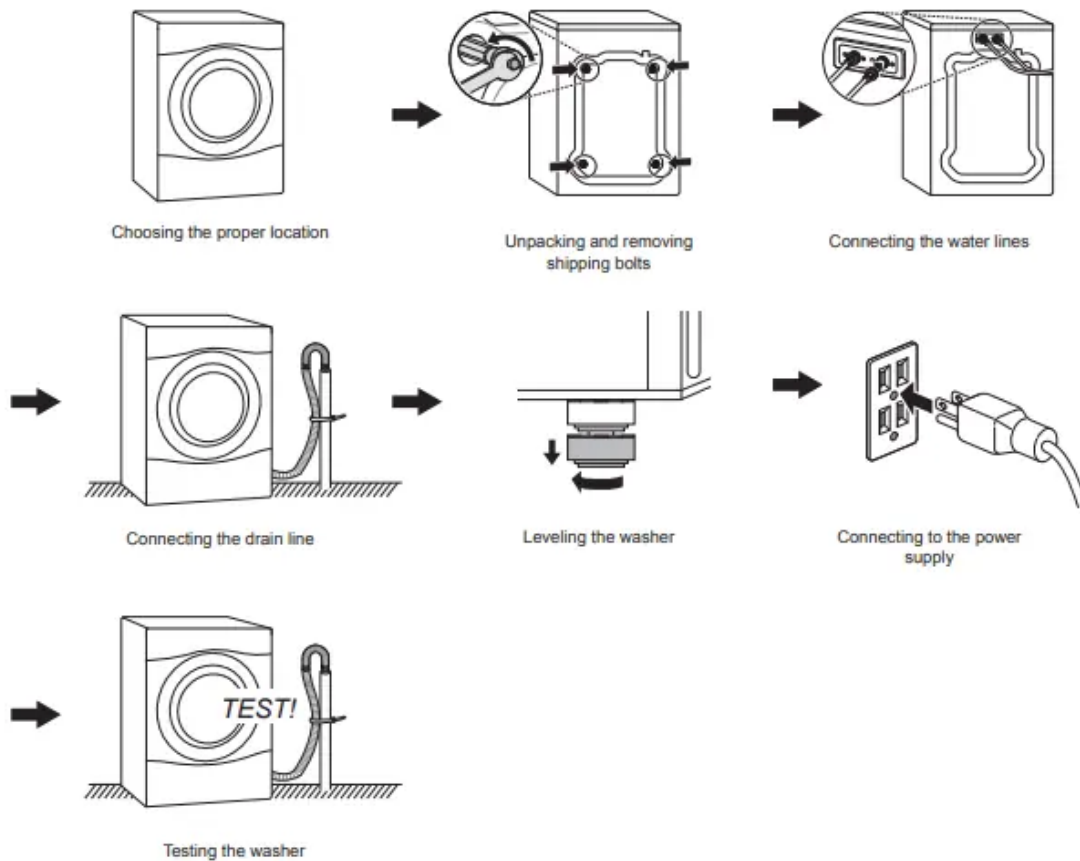

Product Specifications

The appearance and specifications listed in this manual may vary due to constant product improvements.

| | |
|-----------------------------------|---|
| Electrical requirements | 120 VAC @ 60 Hz |
| Min. / Max. water pressure | 20 – 120 psi (138–827 kPa) |
| Dimensions | 70 cm(W) X 77 cm(D) X 99 cm(H), 139.6 cm (D with door open) 27"(W) X 30 1/4"(D) X 39"(H), 55" (D with door open) |
| Net weight | 187.4 lb (85 kg) |
| Max spin speed | 1300 RPM |

WARNING

- Moving or installation of the appliance requires two or more people. Failure to follow these instructions may result in injury.
- Store and install the appliance where it will not be exposed to temperatures below freezing or exposed to outdoor weather conditions. Failure to follow this warning can cause product or part failure, serious injury, fire, electric shock, or death.
- Properly ground the washer to conform with all governing codes and ordinances. Failure to follow this warning can cause serious injury, fire, electric shock, or death.
- To reduce the risk of electric shock, do not install the appliance in humid spaces. Failure to follow this warning can cause serious injury, fire, electric shock, or death.

- To ensure proper airflow, do not block the large opening on the bottom of the washer with carpeting or other materials.
- Do not remove the ground prong. Do not use an adapter or extension cord. Plug into a grounded 3-prong outlet. Failure to follow this warning can cause serious injury, fire, electric shock, or death.
- Certain internal parts are intentionally not grounded and may present a risk of electric shock only during servicing. Service personnel - Do not contact the following parts while the appliance is energized: pump, valve, motor, control board.

Choosing the Proper Location

Install the washer on a solid floor that is strong and rigid enough to support the weight of the washer, even when fully loaded, without flexing or bouncing. If the floor has too much flex, you may need to reinforce it to make it more rigid. If the floor is not solid, it may cause severe vibration and noise.

NOTE

- Before installing the washer, make sure the floor is clean, dry and free of dust, dirt, water and oil so the washer feet cannot slide easily. Leveling feet that can move or slide on the floor can contribute to excess vibration and noise due to poor contact with the floor.
- If a drip pan must be used, take extra care to follow the instructions provided with the drip pan and make sure the leveling feet are adjusted for firm and even contact with the pan. Use of drip pans and failure to properly level the machine may result in increased vibration and noise during operation.
- Allow for sufficient space between the walls and the washer for installation.

Power Outlet

- The power outlet must be within 60 inches (1.5 m) of either side of the washer.
- The appliance and outlet must be positioned so that the plug is easily accessible.
- Do not overload the outlet with more than one appliance.
- The outlet must be grounded in accordance with current electrical wiring codes and regulations. • Use a time-delay fuse or circuit breaker.

NOTE

- It is the personal responsibility and obligation of the product owner to have a proper outlet installed by qualified service personnel.

Flooring

- To minimize noise and vibration, the washer must be installed on a solidly constructed floor.

- Allowable slope under the entire washer is a maximum 1 inch (2.5 cm) difference from side to side or from front to back.
- Installing on carpeting and soft tile surfaces is not recommended.
- Never install the washer on a platform or weakly supported structure.

NOTE

- The washer must be installed on firm flooring to minimize vibration during the spin cycle. Concrete flooring is best, but a wood floor is sufficient, provided it is built to FHA standards.

Floor Installation

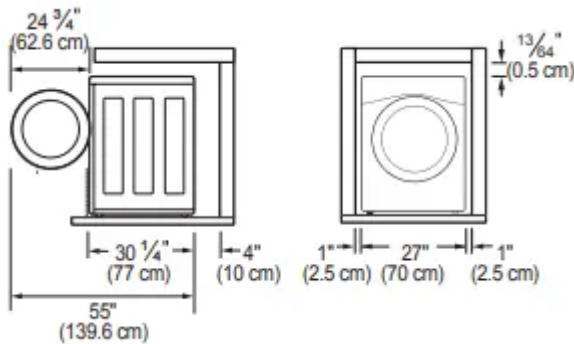

To ensure sufficient clearance for water lines, the drain line and airflow, allow minimum clearances of at least 1 inch (2.5 cm) at the sides and 4 inches (10 cm) behind the unit. Be sure to allow for wall, door, or floor moldings that may increase the required clearances.

Stacked or Pedestal Installation

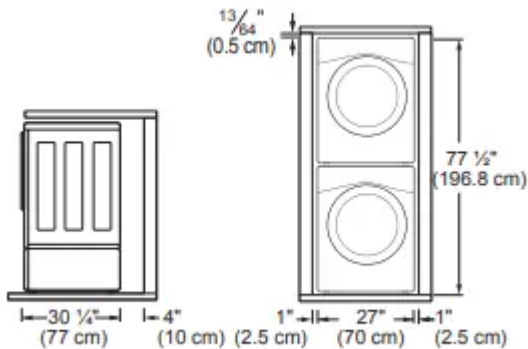

NOTE

- Refer to the instructions packaged with the optional pedestal kit before installing with a pedestal kit.
- Do not use a drip pan with a pedestal or pedestal washer installation as it can block the drawer. Using a drip pan may result in increased vibration and noise during operation.

Unpacking and Removing Shipping Bolts

Unpack all shipping materials from the washer for proper operation and inspect it for shipping damage.

⚠ CAUTION

- Failure to remove shipping materials can cause excessive noise and vibration.

1 Lift the washer off the foam base.

After removing the carton and shipping material, lift the washer off the foam base. Make sure the plastic tub support comes off with the base and is not stuck to the bottom of the washer.

If you must lay the washer down to remove the base packaging materials, always protect the side of the washer and lay it carefully on its side. Do not lay the washer on its front or back.

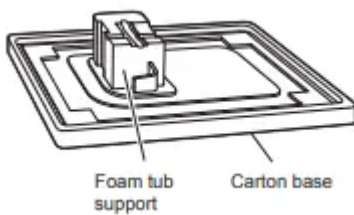

2 Remove the bolt assemblies.

Starting with the bottom two shipping bolts, use the wrench (included) to fully loosen all four shipping bolts by turning them counterclockwise. Remove the bolt assemblies by wiggling them slightly while pulling them out.

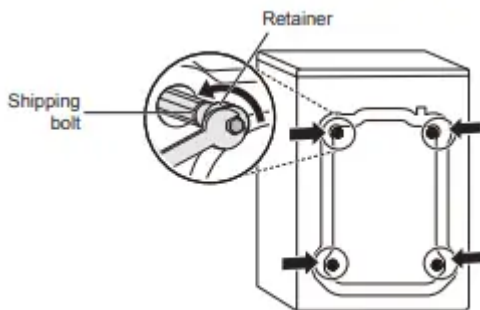

3 Install the hole caps.

Locate the four hole caps included in the accessory pack and install them in the shipping bolt holes.

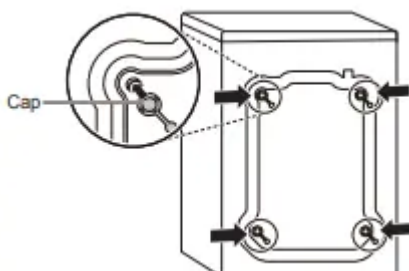

NOTE

- Save the bolt assemblies for future use. To prevent damage to internal components, do not transport the washer without reinstalling the shipping bolts.
- Failure to remove shipping bolts and retainers may cause severe vibration and noise, which can lead to permanent damage to the washer. The cord is secured to the back of the washer with a shipping bolt to help prevent operation with shipping bolts in place.

Connecting the Water Lines

To avoid the risk of costly water damage, purchase and install new inlet hoses when installing the washer.

1 Check the fittings and seals.

Inspect the threaded fitting on each hose and make sure there is a rubber seal in place in both ends of each hose to prevent leaking.

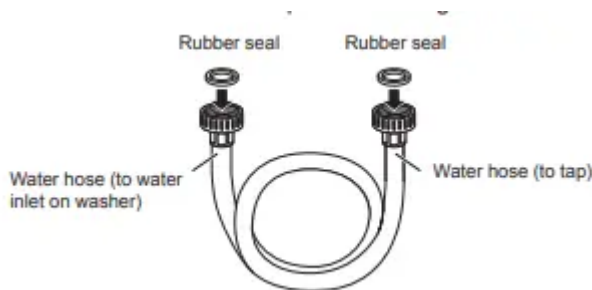

2 Connect the water supply hoses.

Connect the water supply hoses to the hot and cold water faucets tightly by hand and then tighten another $2/3$ turn with pliers. Connect the blue hose to a cold water faucet and the red hose to a hot water faucet.

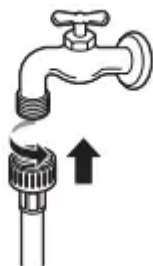

3 Flush out the inlet hoses.

After connecting the inlet hoses to the water faucets, turn on the water faucets to flush out foreign substances (dirt, sand or sawdust) in the water lines. Let water drain into a bucket, and check the water temperature to make sure you've connected the hoses to the correct faucets.



4 Attach the water lines to the back of the washer.

Attach the hot water line to the hot water inlet on the back of the washer. Attach the cold water line to the cold water inlet on the back of the washer. Tighten the fittings securely. Turn ON both faucets all the way and check for leaks at both ends of the hoses.

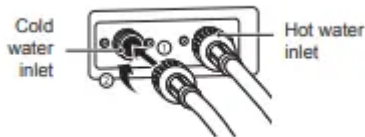

⚠ WARNING

- Do not overtighten the hoses or cross-thread the hose fittings. Overtightening or cross-threading can damage the valves or couplings, resulting in leaking and property damage.
- Do not reuse old hoses. Use only new hoses when installing the washer. Old hoses could leak or burst causing flooding and property damage. Contact an LG Customer Information Center for assistance in buying hoses.

Connecting the Drain Hose

Connect the drain hose to either a standpipe or laundry tub.

NOTE

- The drain hose should always be properly secured. Failure to properly secure the drain hose can result in flooding and property damage.
- The drain must be installed in accordance with any applicable local codes and regulations.
- Make sure that the drain hose is not stretched, pinched, crushed, or kinked.
- Do not install the drain hose with the end lower than 29.5 inches (0.7 m) or higher than 96 inches (2.4 m) above the bottom of the washer or more than 60 inches (1.5 m) away from the washer.

- Never create an airtight seal between the hose and the drain with tape or other means. If no air gap is present, water can be siphoned out of the tub resulting in poor wash/rinse performance or clothing damage.

Option 1: Standpipe

1 Clip the end of the hose into the elbow bracket.

Connect the elbow bracket within 4 inches (10 cm) of the end of the drain hose. If the drain hose is extended more than 4 inches (10 cm) beyond the end of the elbow bracket, mold or microorganisms could spread to the inside of the washer.

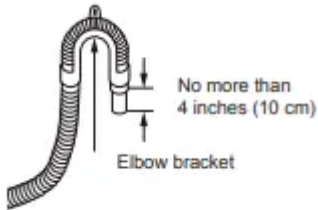

2 Insert the end of the drain hose into the standpipe.

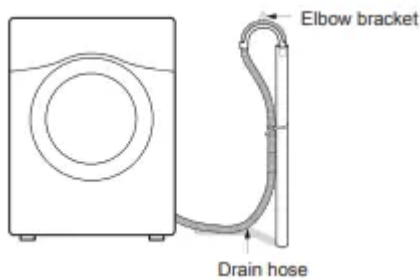

3 Use a tie strap to secure the drain hose in place.

Option 2: Laundry Tub

1 Clip the end of the hose into the elbow bracket.

Connect the elbow bracket within 4 inches (10 cm) of the end of the drain hose. If the drain hose is extended more than 4 inches (10 cm) beyond the end of the elbow bracket, mold or microorganisms could spread to the inside of the washer.

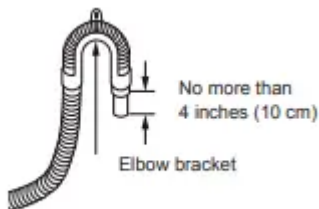

2 Hang the end of the drain hose over the side of the laundry tub.

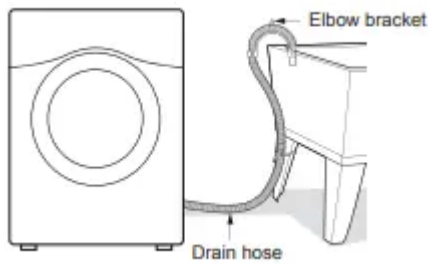

3 Use a tie strap to secure the drain hose in place.

Leveling the Washer

The drum of your new washer spins at very high speeds. To minimize vibration, noise, and unwanted movement, the floor must be a level, solid surface.

NOTE

- Adjust the leveling feet only as far as necessary to level the washer. Extending the leveling feet more than necessary can cause the washer to vibrate.
- Before installing the washer, make sure that the floor is clean, dry and free of dust, dirt, water and oil so the washer feet cannot slide easily. Feet that move or slide on the floor can contribute to excessive vibrat

1 Position the washer in its final location.

Take special care not to pinch, strain, or crush the water and drain lines. If you have a carpenter's level, you can place it across the top of the washer. The slope beneath the washer should not exceed 1 inch, and all four leveling feet must rest firmly on the floor.

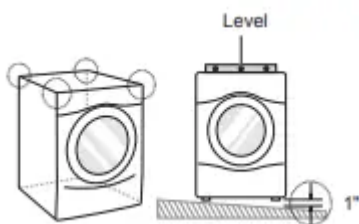

2 Adjust the lower leveling feet.

Turn in one direction to raise the washer or the other direction to lower it.



3 Tighten the locknuts.

Turn the locknuts counter-clockwise and tighten them when the washer is level.



4 Recheck the washer's levelness.

Push or rock the top edges of the washer gently to make sure the washer does not rock. If the washer rocks, repeat steps 1-3.

Testing the Washer

Check if the washer is properly installed and run a test cycle.

1 Load the washer with 6 pounds of laundry (approximately 6 thick bath towels).

2 Press the Power button.

3 Press the Rinse+Spin button.

4 Press the Start/Pause button. The wash cycle starts.

5 Check if water is supplied, that the machine does not rock or vibrate excessively, and that it drains well during the spin cycle.

NOTE

- If water leaks during water supply, see Connecting the Water Lines to connect them properly.
- If the washer rocks and vibrates excessively, see Leveling the Washer to level it again.
- If the drain does not work, see Connecting the Drain Hose to install the hose properly

OPERATION

Using the Washer

WARNING

- To reduce the risk of fire, electric shock, or injury to persons, read the SAFETY INSTRUCTIONS before operating this appliance.



Sort Laundry and Load the Washer

Sort laundry by fabric type, soil level, color and load size, as needed. Open the door and load items into the washer. If using detergent pods, place pod in drum before loading laundry



Add Cleaning Products.

Add the proper amount of HE (High-Efficiency) detergent to the detergent dispenser. If desired, add bleach or fabric softener to the appropriate areas of the dispenser drawer. Do not place liquid or powdered detergent pods in the dispenser.



Turn on the Washer

Press the Power button to turn on the washer. The lights above the cycle buttons will illuminate and a chime will sound.



Select a Cycle

Turn the Cycle Selector Knob until the desired cycle is selected. The preset Temp., Spin, Soil and option settings for that cycle will be shown. Pressing the Start/Pause button without selecting a cycle will cause the Normal cycle to begin immediately



Adjust Settings

Default settings for the selected cycle can now be changed, if desired, using the cycle modifier and option buttons.

- Not all modifiers and options are available on all cycles. A different chime will sound and the LED will not come on if the selection is not allowed.



Begin Cycle

Press the Start/Pause button to begin the cycle. The washer will agitate briefly without water to measure the weight of the load. If the Start/Pause button is not pressed within 60 minutes, the washer will shut off and all settings will be lost.



End of Cycle

When the cycle is finished, a melody will sound. Immediately remove your clothing from the washer to reduce wrinkling. Check around the door seal when removing the load for small items that may be caught in the seal.

NOTE

- The washer rotates the laundry in a way that allows it to use less water while still fully saturating your clothing. It is normal to not be able to see water during the wash cycle.
- If the temperature or the water level inside the machine is too high, the door will not unlock when the Start/ Pause button is pressed. To open the door in these circumstances, press Add Garments. To stop a cycle and drain the water completely, turn the power off, then on, and then press Rinse+Spin.

Loading the Washer

- Check and empty pockets. Paper clips, coins, matches, etc. can damage clothing and the washer.
- Close zippers and hooks, and tie drawstrings to prevent snagging or tangling of clothes.
- Pretreat heavily stained areas for best results.
- Combine large and small items in a load. Load large items first. Large items should not be more than half of total load.
- The washer can be fully loaded, but the drum should not be tightly packed with items. The door of the washer must close easily.
- Do not wash single small items. Add 1-2 similar items to the load to prevent an out-of-balance load.
- Wash thick, bulky items individually. Heavy blankets, comforters, bedspreads, or pet beds can get tangled or cause an unbalanced load if combined with other items.
- Do not wash/spin waterproof items. Washing raincoats or sleeping bags may result in abnormal vibration or may cause the load to bounce, which could damage the drum.
- Wash small, light items in a mesh bag. Items like underwear can get caught in the door seal, and a brassiere hook may damage other items or the drum.
- Brush off heavy soil, dust, and hair from items before washing. Excess dirt or sand can abrade other fabrics and lead to poor wash performance.
- For best performance, load clothes as shown.

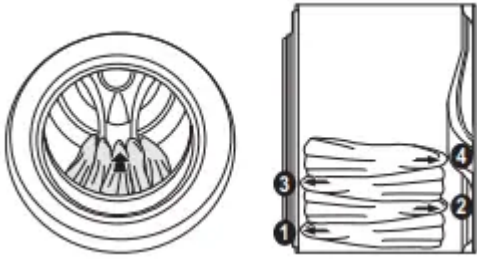

- Load clothes loosely, and do not overfill the drum. Clothes need room to circulate in order to get clean.
- Do not press down on items while stacking them in the drum.

SMART FUNCTIONS

LG SmartThinQ Application

The LG SmartThinQ application allows you to communicate with the appliance using a smartphone.

Before Using LG SmartThinQ

1 Use a smartphone to check the strength of the wireless router (Wi-Fi network) near the appliance.

- If the distance between the appliance and the wireless router is too far, the signal strength becomes weak. It may take a long time to register or installation may fail.

2 Turn off the Mobile data or Cellular Data on your smartphone.

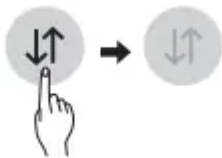

3 Connect your smartphone to the wireless router.



NOTE

- To verify the Wi-Fi connection, check that Wi-Fi icon on the control panel is lit.
- The appliance supports 2.4 GHz Wi-Fi networks only. To check your network frequency, contact your Internet service provider or refer to your wireless router manual.

- LG SmartThinQ is not responsible for any network connection problems or any faults, malfunctions, or errors caused by network connection.
- The surrounding wireless environment can make the wireless network service run slowly. • If the appliance is having trouble connecting to the Wi-Fi network, it may be too far from the router. Purchase a Wi-Fi repeater (range extender) to improve the Wi-Fi signal strength.
- The network connection may not work properly depending on the Internet service provider.
- The Wi-Fi connection may not connect or may be interrupted because of the home network environment.
- If the appliance cannot be registered due to problems with the wireless signal transmission, unplug the appliance and wait about a minute before trying again.
- If the firewall on your wireless router is enabled, disable the firewall or add an exception to it.
- The wireless network name (SSID) should be a combination of English letters and numbers. (Do not use special characters.)
- Smartphone user interface (UI) may vary depending on the mobile operating system (OS) and the manufacturer.
- If the security protocol of the router is set to WEP, network setup may fail. Change the security protocol (WPA2 is recommended), and register the product again.

Installing the LG SmartThinQ Application

Search for the LG SmartThinQ application from the Google Play Store or Apple App Store on a smart phone. Follow instructions to download and install the application.

LG SmartThinQ Application Features

Washer Cycle (Remote Start, Downloaded)

Set or download any preferred cycle and operate by remote control.

Tub Clean Coach

This function shows how many cycles remain before it is time to run the Tub Clean cycle.

Smart Diagnosis™

This function provides useful information for diagnosing and solving issues with the appliance based on the pattern of use.

Energy Monitoring

The washer energy usage is affected by the cycles and options so you may see some changes in energy usage from one cycle to another.

Push Alerts

When the cycle is complete or the appliance has problems, you have the option of receiving push notifications on a smart phone.

Settings

Set the product nickname and delete product.

Using Washer Cycle

Remote Start

Use a smart phone to control the appliance remotely or check to see how much time is left in the cycle.

Using Remote Start

- 1 Press the Power button.
- 2 Load the laundry.
- 3 Press and hold Remote Start button for 3 seconds to enable the Remote Start function.
- 4 Start a cycle from the LG SmartThinQ application on your smart phone

NOTE

- Once the Remote Start mode is enabled, you can start a cycle from the LG SmartThinQ smartphone application. If the cycle is not started, the machine will wait to start the cycle until it is turned off remotely from the application or the Remote Start mode is disabled.
- When Remote Start is turned on, the door is automatically locked.

Disabling Remote Start

When the Remote Start is activated, press and hold the Remote Start button for 3 seconds.

Downloaded

Download new and specialized cycles that are not included in the standard cycles on the appliance.

Appliances that have been successfully registered can download a variety of specialty cycles specific to the appliance. Only one cycle can be stored on the appliance at a time.

Once cycle download is completed in the appliance, the appliance keeps the downloaded cycle until a new cycle is downloaded.

MAINTENANCE

Care and Cleaning of the Interior

- Use a towel or soft cloth to wipe around the washer door opening and door glass.

- Always remove items from the washer as soon as the cycle is complete. Leaving damp items in the washer can cause wrinkling, color transfer, and odor.
- Run the Tub Clean cycle once a month, or more often if needed, to remove detergent buildup and other residue.

Cleaning the Drum

Over time, residue may build up in the drum, leading to mildew or a musty odor. Run the Tub Clean cycle monthly to remove residue and prevent odor. Run the cycle more often under heavy use conditions or if odor is already present.

- 1 Remove any clothing from the drum.
- 2 Add cleaning agents.

| Cleaner | Instructions |
|------------------------|---|
| Drum cleaner | Add to main detergent compartment of detergent dispenser |
| Lime scale remover | |
| Liquid chlorine bleach | Add to bleach compartment of detergent dispenser |
| Powdered cleaner | Pull out liquid detergent cup before adding to main detergent compartment |
| Cleaning tablets | Place directly into washer drum |

- For other drum cleaning products, follow the cleaner manufacturer's instructions and recommendations.
 - Do not exceed the maximum fill line when adding bleach or powdered cleaners. Powdered detergent may remain in the drum after cleaning.
- 3 Close the door and press the Power button to turn the washer on.
 - 4 Turn the cycle selector to select the Tub Clean cycle.
 - 5 Press the Start/Pause button to begin the cycle. Selecting any other cycle after Tub Clean has been selected will cause the Tub Clean cycle to be cancelled.
 - 6 After the cycle ends, open the door and allow the drum interior to dry completely.

NOTE

- Never load laundry while using Tub Clean. The laundry may be damaged or contaminated with cleaning products. Make sure to run the Tub Clean cycle only when the drum is empty.
- Leave the door open after finishing the laundry, to keep the drum clean.
- Tub Clean should be repeated monthly.
- If mildew or musty smell already exists, run Tub Clean once a week for three consecutive weeks.

Automatic Alert for Tub Clean

When the power is on and the message blinks on the display, it means the washer drum needs cleaning. Use the Tub Clean cycle to clean the washer drum. The frequency of the automatic alert's appearance depends on how often the washer is used, however the message will generally appear every one to two months.

Removing Mineral Buildup

In areas with hard water, mineral scale can form on internal components of the washer. Periodically clean the mineral buildup on the internal components to extend the lifespan of the washer. Use of a water softener is recommended in areas with hard water.

- Use a descaler, such as Washer Magic®, to remove visible mineral buildup on the washer drum. After descaling, always run the Tub Clean cycle before washing clothing.
- Mineral scale and other spots may be removed from the stainless steel drum using a soft cloth soaked in stainless steel cleaner.
- Do not use steel wool or abrasive cleaners.

NOTE

- If you use a descaler or tub cleaner during the Tub Clean cycle, use the Rinse+Spin cycle to rinse the washer drum before running your next wash cycle.

Cleaning the Detergent Dispenser Drawer

Leaving detergent in the detergent dispenser drawer for an extended period of time or using the washing machine for a long period of time may cause the build-up of scales in the detergent dispenser drawer. Pull out and clean the detergent dispenser drawer once a week.

- 1 Slide the detergent dispenser drawer out as far as it will go.
- 2 Press down hard on the disengage button and pull out the detergent dispenser drawer.

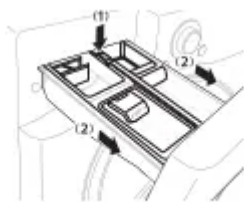

- 3 Remove the inserts from the drawer.
- 4 Clean the inserts with warm water.
 - Use a soft cloth or brush to remove any residue.
 - Use water only when cleaning the drawer and inserts.
- 5 Wipe off any moisture with a dry towel or cloth after cleaning.
- 6 Replace the detergent dispenser drawer.

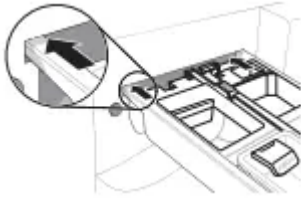

Cleaning the Door Seal

Clean the door seal once a month to prevent build-up of dirt.

1. Wear rubber gloves and protective goggles.
2. Dilute 3/4 cup (177 ml) of liquid chlorine bleach in 1 gallon (3.8 L) of water.
3. Wipe around the door seal. Soak a sponge or a soft cloth in this diluted solution and wipe all around the door seal.
4. Wipe dry. After cleaning, wipe up any moisture with a dry towel or cloth.
5. Leave the door open to allow the door seal to dry completely

Cleaning the Water Inlet Filters

If the washer does not fill properly, an error message will show on the display. The inlet valve filter screens could be plugged by hard water scale, sediment in the water supply, or other debris.

- 1 Turn off both water faucets completely.
- 2 Unscrew the hot and cold water hoses from the back of the washer.
- 3 Carefully remove the filters from the water valves.
- 4 Remove foreign objects and soak the filters in white vinegar or a lime scale remover. If using a lime scale remover, follow the manufacturer's instructions. Be careful not to damage the filters while cleaning them.
- 5 Rinse filters thoroughly and press them back into place.
- 6 Flush then reattach the water hoses. Before reattaching the hoses, flush the hoses and water lines by running several gallons of water into a bucket or drain, preferably with the faucets wide open for maximum flow.

Cleaning the Drain Pump Filter

The washer fails to drain if the drain pump filter is clogged. Periodically clean the drain filter to prevent clogging with foreign objects.

WARNING

- Opening the drain filter will result in water overflowing if there is water in the washer drum. Use a bucket if the drum is not completely drained before you open the drain filter.

- Using the washer without the drain filter or with an incorrectly assembled drain filter may cause leaks or malfunctioning of the washer.

1 Turn off the machine and unplug it.

2 Open the drain pump filter cover.

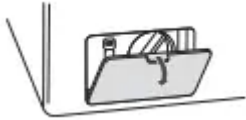

3 Drain any remaining water. Unclip the drain hose and remove the plug from the drain hose to drain the remaining water.



4 Remove the pump filter. Twist the pump filter counterclockwise to remove



5 Clean the pump filter and opening.



6 Recap the plug onto the drain hose and attach the drain hose.

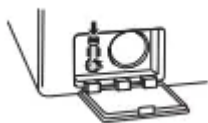

7 Insert the drain pump filter.



8 Close the drain pump filter cover.

Care in Cold Climates

Storing the Washer

If the washer will not be used for an extended period of time and is in an area that could be exposed to freezing temperatures, perform the following steps to protect the washer from damage.

- 1 Turn off the water supply.
- 2 Disconnect the hoses from the water supply and drain any water from the hoses.

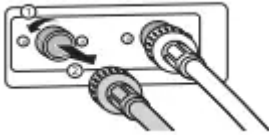

- 3 Plug the power cord into a properly grounded electrical outlet.
- 4 Add 1 gallon of nontoxic recreational vehicle (RV) antifreeze to the empty drum and close the door. Never use automotive antifreeze.
- 5 Press the Power button, then select Spin.
- 6 Press the Start/Pause button to start the drain pump.
- 7 Allow the drain pump to run for one minute, then press the Power button to shut off the washer. This will expel some of the antifreeze, leaving enough to protect the washer from damage.
- 8 Unplug the power cord, dry the drum interior with a soft cloth, and close the door.
- 9 Remove the inserts from the dispenser. Drain any water in the compartments and let them dry.
- 10 Store the washer in an upright position.
- 11 To remove the antifreeze from the washer after storage, run a complete Speed Wash cycle using detergent.

- Do not add laundry to this cycle.

When the Water Line is Frozen

- 1 Turn off the faucets connected to the water lines.
- 2 Pour hot water on the frozen faucets to thaw the water lines and remove them.
- 3 Immerse the water lines in hot water to thaw them.
- 4 Connect the water lines with the water inlets of the washer and with the faucets. See Connecting the Water Lines for details.
- 5 Turn on the faucets.
- 6 Press the Power button.

7 Press the Spin button.

8 Press the Start/Pause button. Verify the water fills properly

When the Drain Line is Frozen

1 Pour hot water in the washer drum and close the lid. Wait for 1-2 hours.

2 Press the Power button after thawing.

3 Press the Spin button to select draining and spinning.

4 Press the Start/Pause button. Check to make sure the water drains.

TROUBLESHOOTING

FAQs: Frequently Asked Questions

Why does my washer make loud banging noises while it is filling with water?

This is actually a problem with the plumbing in your home. When the water valve in the washer shuts off, it can cause pipes in your home to move, resulting in a loud banging noise. This effect, called water hammer, can be reduced by installing an item called a water hammer arrestor. Add-on arrestors can be purchased through your local hardware or home improvement store.

Why is there so little water in my washer? How can it clean the clothes?

HE (High-Efficiency) washers are designed to properly wash your laundry while using a minimum amount of water and energy. Because the water volume is low, the small amount of detergent used is more concentrated in the water, resulting in excellent cleaning performance.

When I press a button, why does my washer beep and then nothing happens?

The Control Lock feature is turned on. To turn off Control Lock, turn the washer on, then press and hold the button that has "*Control Lock" on or under it for three seconds. • Power or Signal is off.

Where should I pour my OxiClean™ or other powdered laundry products when doing my laundry?

If you are using powdered laundry detergent, load it in the main detergent dispenser after removing the liquid detergent insert. Powdered laundry agents such as OxiClean™ or powdered color safe bleach should be put directly into the tub. These products can be put in the empty tub before loading or on top of the laundry after loading the machine.

Before Calling for Service

The washer is equipped with an automatic error-monitoring system to detect and diagnose problems at an early stage. If the washer does not function properly or does not function at all, check the following before you call for service.

Spraying or Hissing

Water spraying or circulating during the cycle.

- Normal Operation

Humming or Gurgling

Drain pump is pumping water from the washer at times during a cycle.

- Normal Operation

Water sloshing

A liquid in the balance ring around the wash basket helps the basket spin smoothly.

- Normal Operation

Water being added after the washer has already begun to operate

The washer adapts to the load size and type to add more water to the cycle as needed.

If the washer senses that the load is unbalanced, it will stop and refill to redistribute the load.

The washer may be diluting laundry additives to add to the wash load.

- Normal Operation The wash load may be unbalanced.

Rattling and clanking noise

Foreign objects, such as keys, coins, or safety pins may be in drum or pump.

- Stop washer, check drum and drain filter for foreign objects. If noise continues after washer is restarted, call for service.

Thumping sound

Heavy wash loads may produce a thumping sound.

- This is normal. If sound continues, washer is probably out of balance. Stop and redistribute wash load.

Wash load may be out of balance.

- Pause the cycle and redistribute the load.

Vibrating noise

Packaging materials were not removed.

- See the Unpacking and Removing Shipping Bolts information in the Installation section.

Wash load may be unevenly distributed in the drum.

- Pause the cycle and redistribute the load.

Not all leveling feet are resting firmly and evenly on the floor.

- See Leveling the Washer in the Installation section.

Floor not rigid enough.

- Make sure that the floor is solid and does not flex. See the Flooring in the Installation section.

Squeaking noise

Packaging materials were not removed.

- See the Unpacking and Removing Shipping Bolts information in the Installation section.

Water leaking

Inlet hose connection is loose at faucet or washer.

- Check hoses for leaks, cracks and splits.
- Check and tighten hose connections.

House drain pipes are clogged.

- The washer pumps out water very rapidly. Check for water backing up out of the drain pipe during drain. If water is seen coming out of the drain, check for proper drain hose installation and check for restrictions in the drain. Contact a plumber to repair drain pipe.

Drain hose has come out of drain or is not inserted far enough.

- Tie drain hose to inlet hose or standpipe to prevent it from coming out during drain. For smaller drain pipes, insert the drain hose into the pipe as far as the drain hose flange. For larger drain pipes, insert the drain hose into the pipe 1-2 inches past the flange.

A large item such as a pillow or blanket is above the top of the drum.

- Use the Bedding cycle for large or bulky items. Use extra care and never wash more than half a load of items that float, such as pillows.
- Stop the washer and check the load. Make sure the load does not crest above the top edge of the drum.

Oversudsing of detergent.

- Oversudsing may create leaks, and may be caused by the type and amount of detergent used. High-Efficiency detergent is the only detergent recommended. The normal amount of detergent to use is 1/4 to 1/2 of the maximum amount recommended by the detergent manufacturer.

Water leaks every load

Hoses not installed correctly.

- See Connecting the Water Lines to reinstall hoses. Replace damaged hoses.

Washer will not drain water

Kinked drain hose.

- Ensure that the drain hose is not kinked.

Drain located improperly.

- Make sure that the drain hose is no more than 5 ft. (1.5 m) away from the washer.

Excessive sudsing

Too much detergent or incorrect detergent.

- HE detergents are formulated specifically for High-Efficiency washers and contain sudsreducing agents. Only use detergent with the High-Efficiency (HE) logo.

Washer will not turn on

Power cord is not properly plugged in.

- Make sure that the plug is plugged securely into a grounded, 3-prong, 120 VAC, 60 Hz outlet.

House fuse is blown, circuit breaker has tripped, or power outage has occurred.

- Reset circuit breaker or replace fuse. Do not increase fuse capacity. If the problem is a circuit overload, have it corrected by a qualified electrician.

Wash cycle time is longer than usual

The washer automatically adjusts the wash time for the amount of laundry, water pressure and other operating conditions.

- This is normal. The washer adjusts cycle time automatically to provide optimal results for the selected cycle. The time remaining shown in the display is only an estimate. Actual time may vary.

Water level is too low/ No water is visible in the drum

Energy efficiency

- This is an High-Efficiency (HE) washer. As a result, the water level settings for this washer may be different than on your previous washer. The water will not normally cover the clothes. The fill level is optimized for the wash motion to achieve the best wash performance.

Wrinkling

Washer not unloaded promptly.

- Always remove items from the washer as soon as the cycle is complete.

Washer overloaded.

- The washer can be fully loaded, but the drum should not be tightly packed with items. The lid of the washer should close easily.

Hot and cold water inlet hoses are reversed.

- Hot water rinse can set wrinkles in garments. Check the inlet hose connections.

Staining

Bleach or softener dispensed too soon.

- Dispenser compartment is overfilled causing bleach or softener to dispense immediately. Always measure bleach to prevent overfilling - one cup maximum. Dispenser drawer closed too quickly causing softener to dispense immediately.

Bleach or softener was added directly to the wash load in the drum.

- Always use the dispensers to ensure that laundry products are properly dispensed at the right time in the cycle.

Washer was not unloaded promptly.

- Always remove items from the washer as soon as possible after the cycle is complete.

Clothes were not properly sorted.

- Always wash dark colors separately from light colors and whites to prevent discoloration. Never wash heavily soiled items with lightly soiled items.

Poor stain removal

Proper options not selected.

- Heavier soils and tougher stains may require extra cleaning power. Select the Heavy feature to boost the cleaning power of the selected cycle.

Previously set stains.

- Articles that have previously been washed may have stains that have been set. These stains may be difficult to remove and may require hand washing or pre-treating to aid in stain removal.

Odor

Some odor is caused by the rubber attached to the washing machine.

- This odor is normal for new rubber and will disappear after the machine has been run a few times

. If the rubber door gasket and door seal area are not cleaned regularly, odors can occur from mold or foreign substances.

- Be sure to clean the gasket and door seal regularly and check under the door seal for small items when unloading the washer.

Odors can occur if foreign substances are left in the drainage pump filter.

- Be sure to clean the drainage pump filter regularly

Odors can occur if the drainage hose is not properly installed, causing siphoning (water flowing back inside the washing machine).

- When installing the drainage hose, be sure that it doesn't become kinked or blocked.

Using the dry function, odors can occur from lint and other laundry matter sticking to the heater. (Dryer model only)

- This is not a malfunction.

A particular odor can occur from drying wet clothes with hot air. (Dryer model only)

- The odor will disappear after a short while.

Error Codes

Washer fills with water slowly or not at all, or

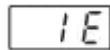

Water supply faucets are not fully open.

- Make sure that the water faucets are fully open.

Water line hoses are kinked, pinched, or crushed.

- Make sure that the hoses are not kinked or pinched.

Be careful when moving the washer during cleaning and maintenance. Water inlet filters are clogged.

- Clean the inlet filters. See the Maintenance section.

Water supply pressure to faucet or house is too low.

- Check another faucet in the house to make sure that household water pressure is adequate and flow is not restricted. Disconnect the inlet hose from the washer and run a few gallons of water through the hose to flush the water supply lines. If flow is too low, contact a plumber to have the water lines repaired.

Water supply connected with leaklimiting hoses.

- Hoses designed to limit leaks can trip falsely and prevent the washer from filling. The use of leaklimiting hoses is not recommended



If the balance is not successful, this error will be displayed.

- The automatic attempt to rebalance the load was not successful. The cycle has been paused to allow the load to be manually adjusted.

The load is too small.

- Small loads may need additional items to be added to allow the washer to balance the loads.

Heavy articles are mixed with lighter items.

- The load may have heavy items loaded with lighter items. Always try to wash articles of somewhat similar weight to allow the washer to evenly distribute the weight of the load for spinning

. The load is out of balance.

- Manually redistribute the load if articles have become tangled, preventing the automatic distribution from working properly.

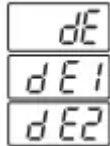

The tub does not rotate or

The door is not secured.

- Close and secure the door. If the message keeps appearing, unplug the power cord and call for service.

Water in the washer drains slowly or not at all and

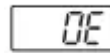

Drain hose is kinked, pinched, or clogged

- Make sure the drain hose is free of clogs or kinks, and is not pinched behind or under the washer.

Drain discharge is more than 96 inches (2.4 m) above bottom of washer.

- The end of the drain hose should be no more than 96 inches (2.4 m) above the bottom of the washer.

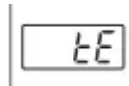

Control error.

- Unplug the washer and wait 60 seconds. Reconnect power and try again. If the error reappears, call for service

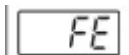

Water level is too high due to a faulty water valve.

- Close the water faucets, unplug the washer, and call for service.

PE

The water level sensor is not working correctly.

- Close the water faucets, unplug the washer, and call for service.

LE

A motor error has occurred.

- Allow the washer to stand for 30 minutes and then restart the cycle. If the LE error code persists, call for service.

Sud

If the washing machine detects too many suds, it displays this error code and adds a Suds Reducing cycle. This adds about 2 hours to the cycle time. If too many suds are detected during spinning, the washing machine stops to help prevent leaking.

- Do not add more than the manufacturer's recommended amount of detergent.

PF

The water level too low or high compared to the size of the load.

- The water level sensor is not working correctly.

FF

Unplug the power cord and call for service. Inlet hose, drain hose or drain pump frozen.

- See the Care in Cold Climates section for instructions.

CL

Control Lock is activated.

- This is not an error code. This code indicates that the Control Lock is activated. Press and hold Control Lock for 3 seconds.

ECL

Tub Clean is activated or the washer drum needs cleaning.

- This is not an error code. This code indicates that the Tub Clean is activated or needed. Use the Tub Clean cycle to clean the washer drum.

Warning

This content is compiled from multiple sources and is provided for reference purposes only. It may not be complete or fully applicable to all situations. If you are unable to resolve your issue, please contact the product manufacturer or an authorized service provider for official support.

Document generated by [ManualsFile](#)