

## Setting up your French Door Refrigerator

### GETTING READY TO INSTALL THE REFRIGERATOR

#### Selecting the best location for the refrigerator

Choose:

- A location with easy access to a water supply
- A location without direct exposure to sunlight.
- A location with a level floor.
- A location with enough space for the refrigerator doors to open easily.
- A location that allows sufficient space to the right, left, back and top for air circulation.
- A location that allows you to move the refrigerator easily if it needs maintenance or service.
- Do not install the refrigerator where the temperature will go below 50 °F (10 °C).
- Do not locate the refrigerator where it may become wet.

#### FLOORING



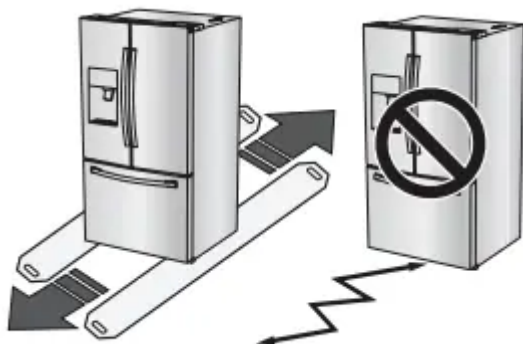

- For proper installation, you must place this refrigerator on a level, hard surface that is the same height as the rest of the floor. This surface should be strong enough to support a fully loaded refrigerator, or approximately 335lbs (152kg). To protect the finish of the flooring, cut a large section of the cardboard carton and place it under the refrigerator where you are working. When moving the refrigerator, you need to pull and push it straight forwards or back. Do not wiggle it from side to side.



#### REQUIRED TOOLS

##### Required Tools (Not provided)

You need the following tools to complete the installation of your refrigerator:

		
Phillips screwdriver(+)	Flat-blade screwdriver(-)	Socket wrench (10mm)
		
Allen wrench (3/16") (5mm)		

## REATTACHING THE REFRIGERATOR DOORS

To reattach the fridge doors after you have moved the fridge to its final location, assemble the parts in reverse order.

1. The Water Line must be fully Inserted to the center of transparent coupler to prevent water leakage from the dispenser.
2. Insert the clip in the top plate and check that it

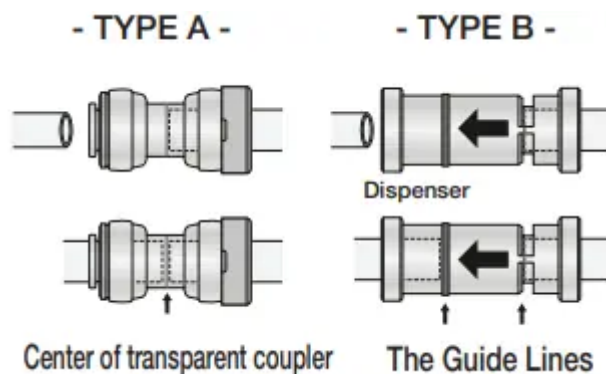

## DISASSEMBLING THE FLEX DOOR

1. Take out the upper drawer by lifting it up.

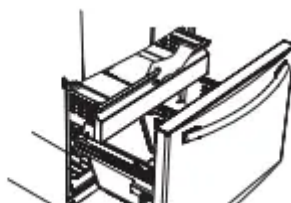

2. Take out the lower basket ( 1 ) by lifting the basket up from the rail system.

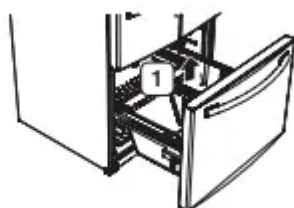

3. Press the fixing hook of rail system.

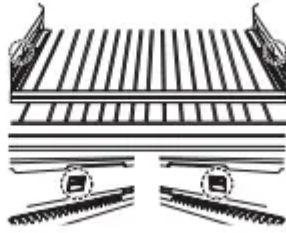

4. Holding the top of the Freezer Drawer, pull it out all the way and then remove it from the

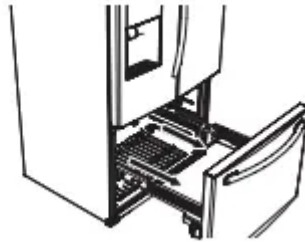

rail system.

## ASSEMBLE THE FREEZER DRAWER

- To reattach the drawer after you have moved the fridge to its final location, assemble the parts in reverse order.

## ADJUSTING THE LEVEL

- Make sure the refrigerator is level so that you can make final adjustments. Use a level to test if the refrigerator is level both side to side and back to front. If the refrigerator is not level, it will not be possible to get the doors perfectly even, which may cause moisture condensation and increased energy bills. Below is an example of how to level the refrigerator if the left side of the refrigerator is lower than the right side.

How to adjust the level

1. Open the freezer drawer and remove the lower basket.
2. Insert a flat-blade screwdriver (-) into the notch on the left control lever, and then turn it counter-clockwise to level the refrigerator. (You turn the lever clockwise to lower the refrigerator and counterclockwise to raise it.)

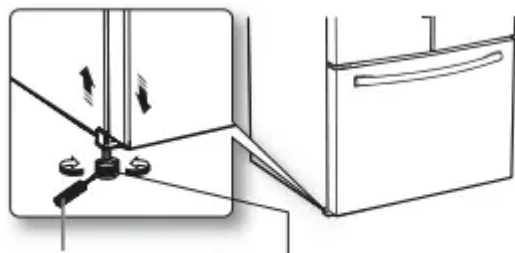

flat-blade screwdriver (-) Control Lever

## INSTALLING THE WATER DISPENSER LINE

- A water dispenser with a filter is one of the helpful features on your new refrigerator. To help promote better health, the water filter removes unwanted particles from your water. However, it does not sterilize or destroy microorganisms. You may need to purchase a water purifying system to do that.
- The water line also connects to the ice maker. For the ice maker to operate properly, water pressure of 20~125psi (138~862 kPa) is required.
- If the refrigerator is installed in an area with low water pressure (below 20psi), you can install a booster pump to compensate for the low pressure.
- After you have connected the water line, make sure the water storage tank inside the refrigerator is properly filled. To do this, press the water dispenser lever until the water runs from the water outlet.

### Connecting to the water supply line

1.



First, shut off the main water supply

2. Locate the nearest cold water drinking line and install the pipe clamp and shut off valve.

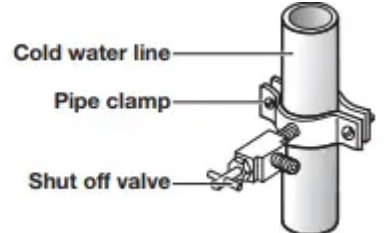

3. Connect the water line installation kit to the shut off valve.

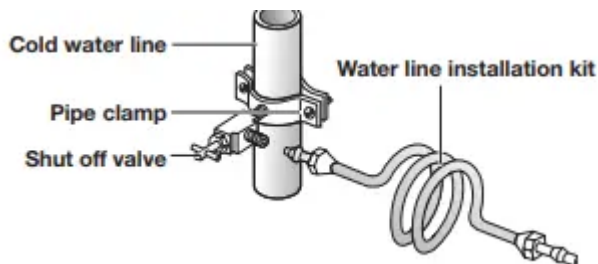

## COMPLETING THE SET UP

Now that you have your new refrigerator installed in place, you are ready to set up and enjoy the features and functions of the appliance. By completing the following steps, your refrigerator should be fully operational.

1. Make sure your refrigerator is in an appropriate location with reasonable clearance between it and the wall. Refer to installation instructions in this manual.
2. Once the refrigerator is plugged in, make sure the interior light comes on when you open the doors.
3. Set the Temperature control to the coldest temperature and wait for an hour. The freezer will get slightly chilled and the motor will run smoothly. Reset the refrigerator and freezer to the temperatures you want.
4. After you plug the refrigerator in, it will take a few hours to reach the appropriate temperature. You can store food and drinks in the refrigerator after the temperature is sufficiently cool.

In the event of a power failure, call the local office of your Electricity Company and ask how long it is going to last.

- Most power failures that are corrected in an hour or two will not affect your refrigerator temperatures. However, you should minimize the number of door openings while the power is off.
- But Should the power failure last more than 24hours, remove all frozen food.

If the key is provided with refrigerator, the keys should be kept out of the reach of children and not be in the vicinity of the appliance. The appliance might not operate consistently (possibility of defrosting of co tents or temperature becoming too warm in the frozen food compartment) when sited for an extended period of time below the cold end of the range of temperatures for which the refrigerating appliance is designed.

Do not store food which goes bad easily at low temperature, such as bananas, melons. Your appliance is frost free, which means there is no need to manually defrost your appliance, as this will be carried out automatically.

Temperature rise during defrosting can comply with ISO requirements. But If you want to prevent an undue rise in the temperature of the frozen food while defrosting the appliance, please wrap the frozen food up in several layers of newspaper. Any increase in temperature of frozen food during defrosting can shorten its storage life.

Do not re-freeze frozen foods that have thawed completely. Install the appliance in a cool, dry room with adequate ventilation. Ensure that it is not exposed to direct sunlight and never put it near a direct source of heat (radiator, for example). Never block any vents or grilles on the appliance. Allow warm food to cool down before placing it in the appliance









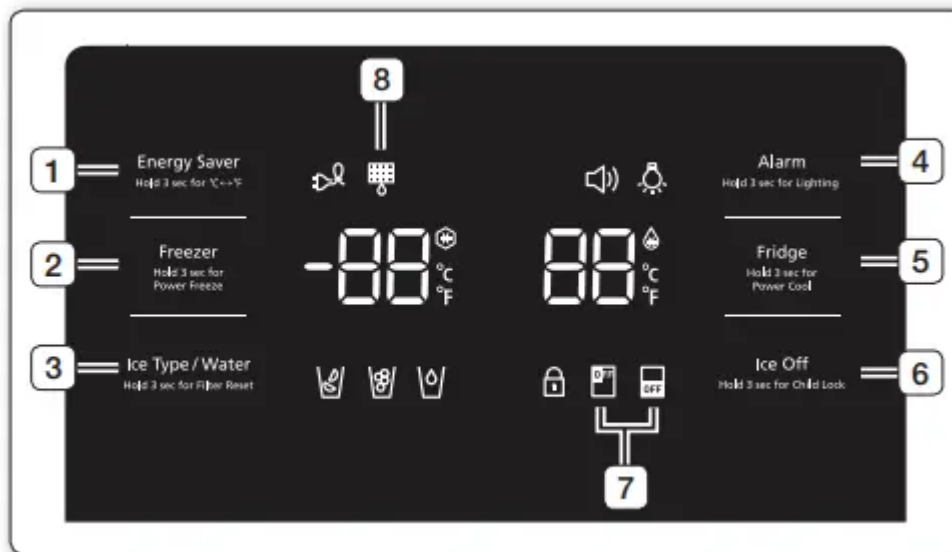



Put frozen food in the refrigerator to thaw. You can then use the low temperatures of the frozen products to cool food in the refrigerator. Do not keep the door of the appliance open for too long when putting food in or taking food out. The shorter time for which the door is open, the less ice will form in the freezer.



Allow clearance to the right, left, back and top when installing. This will help reduce power consumption and keep your energy bills lower.

## Operating your French Door Refrigerator

### USING THE CONTROL PANEL

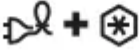

<p><b>( 1 ) Energy Saver</b> Hold 3 sec for °C ↔ °F</p>	<p>Touching this button turns Energy Saver mode on and off. When you turn Energy Saver on, the Energy Saver icon lights. Turn Energy Saver off and the icon goes off. The Energy Saver function automatically turns on when power is supplied to the refrigerator.</p> <p>If condensation or water drops appear on the doors, turn the Energy Saver mode off.</p> <p>Touch and hold this button for 3 seconds to switch the temperature units between °C and °F.</p>		<p><b>( 4 ) Alarm</b> Hold 3 sec for Lighting</p>	<p>To turn the door open alarm on and off If the door alarm is set to On, an alarm beeps if any refrigerator door is left open for more than three minutes. The beeping stops when you close the door. The door alarm function is preset to On in the factory You can turn it off by touching and then releasing this button. You can turn it back on in the same fashion. The icon lights up when the function is on.</p> <p>If you touch and hold the Alarm/Lighting button for 3 seconds, the dispenser LED Lamp will stay on. To turn off the light press the button for 3 seconds again.</p>		
<p><b>( 2 ) Freezer (Hold 3 sec for Power Freeze)</b></p>	<p>Touch this button to set the freezer to your desired temperature. You can set the temperature between -8 °F and 5 °F (between -23 °C and -15 °C). Touch and hold this button for 3 seconds to decrease the time needed to freeze products in the Freezer. It can be helpful if you need to quickly freeze easily spoiled items or if the temperature in the freezer has warmed dramatically (For example, if the door was left open).</p>		<p><b>( 6 ) Ice Off</b> Hold 3 sec for Child Lock</p>	<p>If you don't want to make more ice, touch the Ice Off button. Touching this button for 3 seconds turns on Child Lock which locks the display panel and dispenser buttons so the buttons can not be used. The Child Lock icon lights up to indicate you've activated the Child Lock function. Press 3 seconds to unlock. The Child Lock are not going to lock the Cool Pantry. The lights and motors start until the refrigerator turns off again.</p>		
<p><b>( 3 ) Ice Type/Water</b> Hold 3 sec for Filter Reset</p>	<p>Touch this button to select the ice or water function. You can select water or the types of ice(cubed/crushed ice). Each time you press the button, the cubed and crushed ice modes alternate and the Cubed or Crushed ice icon lights up, indicating your selection.</p> <p>After you replace the water filter, touch and hold this button for 3 seconds to reset the water filter life indicator.</p>		<p><b>( 7 ) Ice Off</b></p>	<p>If you don't want to make more ice, touch the Ice Off button. The icon will light up and the Ice-Maker stops making ice.</p> <p> <b>We recommend you to stop ice making if the following occur:</b></p> <ul style="list-style-type: none"> <li>- There is enough ice in the ice bucket.</li> <li>- You want to save water and energy.</li> <li>- Water is not being supplied to the refrigerator.</li> </ul> <p> <b>If the ice maker function is ON, and the water Line is not connected, there will be a water valve noise from the back of the unit, press the Ice Off (Hold 3sec for child lock) button for less than 3 seconds until the Ice Off Indicator (   ) illuminates.</b></p>	  (RF263T**)	 (RF263B/N**)

<b>( 8 ) Filter</b>	<p><b>Water filter usage</b>  This icon will light up when you need to change the filter. After you use about 300 gallons of water, the filter indicator lights up. (about 6 months). The icon will blink red for several seconds when you open or close the door. After you install the new water filter, reset the filter indicator by touching the Ice Type/Water Hold 3 sec for Filter Reset button.</p>  <ul style="list-style-type: none"> <li> • If water is not dispensing or dispensing slowly, you need to replace the water filter because the water filter is clogged.</li> <li>• Some areas have large amounts of lime in their water, which causes the water filter to clog more quickly.</li> </ul>
<b>Cooling Off Mode</b>	<p>Cooling Off mode (also called Shop mode), is designed for use by retailers when they are displaying refrigerators on the shop floor. In Cooling Off mode, the refrigerator's fan motor and lights work normally, but the compressor does not run, and the refrigerator and freezer do not get cold. To start Cooling Off mode, touch and hold the Energy Saver button and the Freezer button for 5 seconds during normal operation. The refrigerator chime sounds and the temperature display flashes OF OF. To cancel Cooling Off mode, touch and hold the Energy Saver and the Freezer buttons again for 5 seconds.</p> 

## CHANGING THE WATER FILTER

### Removing any residual matter inside the water supply line after installing the water filter.

1. Turn ON the main water supply and supply water to the refrigerator

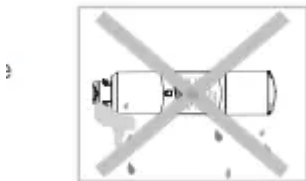

2. Select water in the button "ICE TYPE/ WATER", pour 1 Gal (6-7 minutes) to clean the water supplier system and it will take the air out from the lines.
3. If after pour 1 Gal the water doesn't turn clear is possible an additional flushing in the household lines.
4. Open the Refrigerator door and make sure there are no water leaks coming from the water filter.

### Reverse Osmosis Water Supply

IMPORTANT :

The pressure of the water supply coming out of a reverse osmosis system going to the water inlet valve of the refrigerator needs to be between 35 and 120 psi (241 and 827 kPa).

If a reverse osmosis water filtration system is connected to your cold water supply, the water pressure to the reverse osmosis system needs to be a minimum of 40 to 60 psi (276 to 414 kPa.) If the water pressure to the reverse osmosis system is less than 40 to 60 psi (276 to 414 kPa):

- Check to see whether the sediment filter in the reverse osmosis system is blocked. Replace the filter if necessary.
- Allow the storage tank on the reverse osmosis system to refill after heavy usage.
- If your refrigerator has a water filter, it may further reduce the water pressure when used in conjunction with a reverse osmosis system. Remove the water filter.

## CONTROLLING THE TEMPERATURE

### Basic temperature of Freezer and Refrigerator Compartments

- The basic temperature and recommended temperatures of the Freezer and Refrigerator Compartments are 0 °F and 37 °F(or -18 °C and 3 °C) respectively. If the temperature of the Freezer and Refrigerator Compartments are too high or low, adjust the temperature manually

### Controlling the Freezer temperature



**Recommend Temp (Freezer) : 0 °F (or -18 °C)**

The Freezer temperature can be set between -8 °F and 5 °F (or between -23 °C and -15 °C) to suit your particular needs. Press the Freezer button repeatedly until the desired temperature is shown in the temperature display. The temperature will change by 1 °F (or 1 °C) with each press. See below.

- Fahrenheit : 0 °F → -1 °F → -2 °F → -3 °F → -4 °F → -5 °F → -6 °F → -7 °F → -8 °F → 5 °F → 4 °F → 3 °F → 2 °F → 1 °F → 0 °F
- Centigrade : -18 °C → -19 °C → -20 °C → -21 °C → -22 °C → -23 °C → -15 °C → -16 °C → -17 °C → -18 °C

Keep in mind that foods such as ice cream may melt at 4 °F (or -15.5 °C). The temperature display will move sequentially from -8 °F to 5 °F (or from -23 °C to -15 °C).

## Controlling the fridge temperature

The fridge temperature can be set between 34 °F and 44 °F (or between 1 °C and 7 °C) to suit your particular needs. Press the Fridge button repeatedly until the desired temperature is shown in the temperature display. The temperature will change by 1 °F (or 1 °C) with each press. See below

- Fahrenheit : 37 °F → 36 °F → 35 °F → 34 °F → 44 °F → 43 °F → 42 °F → 41 °F → 40 °F → 39 °F → 38 °F → 37 °F.
- Centigrade : 3 °C → 2 °C → 1 °C → 7 °C → 6 °C → 5 °C → 4 °C → 3 °C.

The temperature control process for the Fridge works just like the Freezer process. Press the Fridge button to set your desired temperature. After a few seconds, the Fridge will begin adjusting towards the newly set temperature. This will be reflected in the digital display

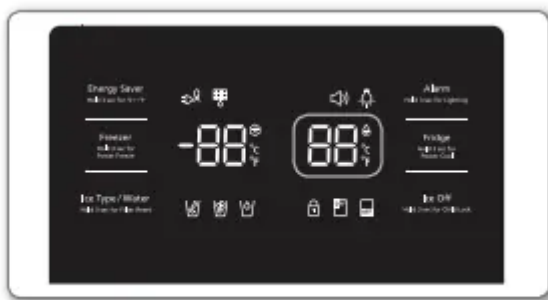

Recommend Temp (Fridge) : 37 °F (or 3 °C)

## PARTS AND FEATURES

Use this page to become more familiar with the parts and features of the refrigerator

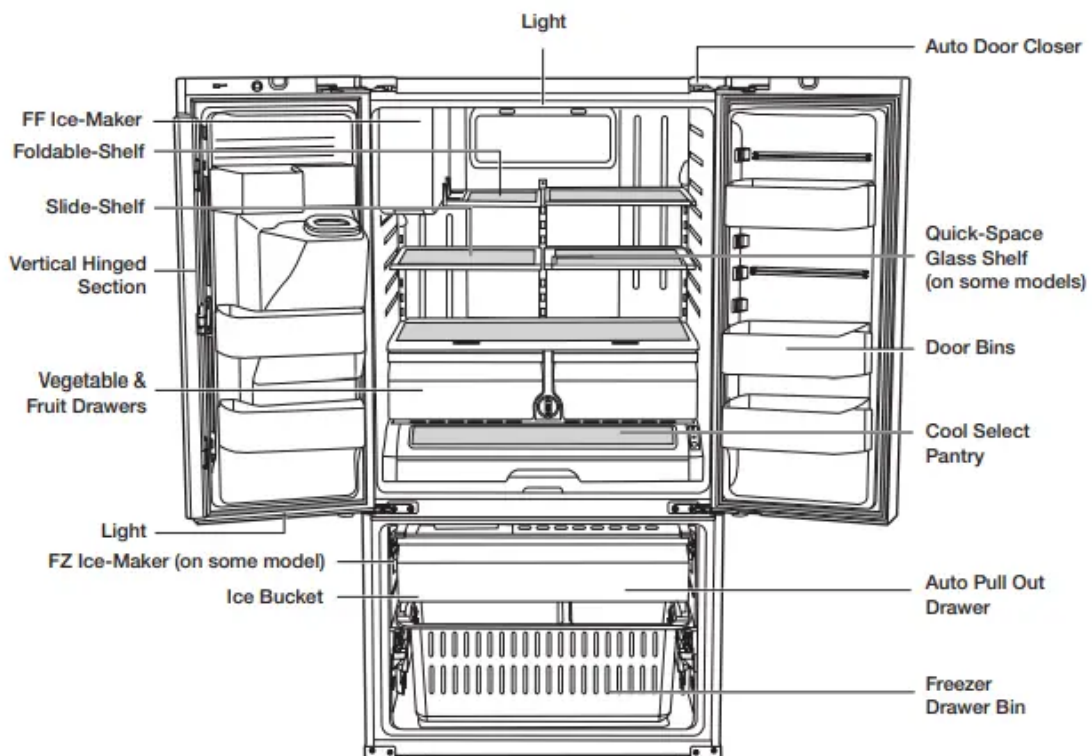

## USING THE COOL SELECT PANTRY

The Cool Select Pantry is a full-width drawer with adjustable temperature control. This pantry can be used for large party trays, deli items, pizza, beverages or miscellaneous items.

There is a temperature control which can adjust the amount of cold air allowed into the pantry. The control is located on the right side of the pantry

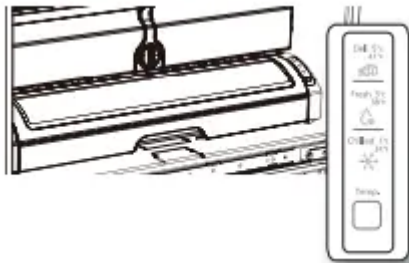

- The Pantry has three modes: The Fresh mode, Chilled mode, and Deli mode. Fresh mode is the default. Press the Temp button repeatedly until the mode you want is lit. Once you select a mode, the temperature will change to match the mode you selected.
- The Pantry temperature may change depending on the number of items inside and where they are located, the ambient temperature, and how often the door is opened.

### The Pantry Selection Button

1. When you select "Deli", the temperature of the pantry will be kept around 41 °F (or 5 °C). This feature helps keep food fresh for a long time.
2. When you select "Fresh", the temperature of the pantry will be kept around 38 °F (or 3

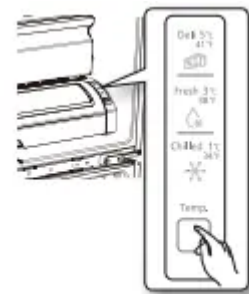

°C). This feature helps keep food fresh for a longer time.

3. When you select "Chilled", the temperature of the pantry will be kept around 34 °F (or 1 °C). This feature also helps keep meat or fish fresh for a longer time. The table below lists the Pantry modes and the kinds of foods that can be stored safely for each mode.

<b>Deli</b>	<b>Fresh</b>	<b>Chiled</b>
• Pineapples	• cucumbers	• steaks
• lemons	• apples	• hard cheeses
• avocado	• oranges	• cold cuts
• potato	• grapes	• bacon
	• zucchinis	• hot dogs
	• corn	

## **CLEANING THE REFRIGERATOR**

Caring for your Samsung French Door Refrigerator prolongs the life of your appliance and helps keep the refrigerator free of odor and germs.

### **Cleaning the Interior**

- Clean the inside walls and accessories with a mild detergent and then wipe dry with a soft cloth. You can remove the drawers and shelves for a more thorough cleaning. Just make sure to dry drawers and shelves before putting them back into place.

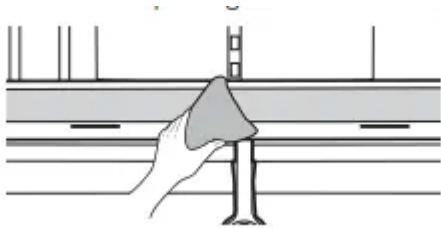

### **Cleaning the Exterior**

- Wipe the control panel and digital display with a damp, clean, soft cloth. Do not spray water directly on the surface of the refrigerator. The doors, handles, and cabinet surfaces should be cleaned with a mild detergent and then wiped dry with a soft cloth. To keep your appliance looking its best, polish the exterior once or twice a year.



### **Cleaning the Ice / Water Dispenser**

Wipe the Ice / Water Dispenser with a clean and soft cloth.

- If the rubber door seals are dirty, the doors may not close properly, and the refrigerator will not operate efficiently. Keep the door seals free of dust or stains by cleaning the doors with a mild detergent and damp cloth. Wipe dry with a clean, soft cloth.

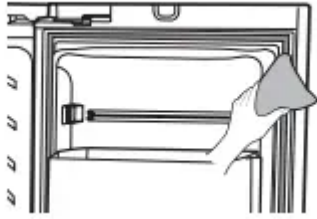

## FOOD STORAGE TIPS

Foods	Refrigerator	Freezer	Storage Tips
<b>DAIRY PRODUCTS</b>			
Butter	2-3 Weeks	6-9 Months	Wrap or cover tightly.
Milk	1-2 Weeks	Not recommended	Check date code. Most milk and similar products are sold in date-coded cartons that indicate a product's peak freshness. Re-seal with cap or wrap tightly. Do not return unused portions to original container.
Cream Cheese, cheese food, and cheese spread	2-4 Weeks	Not recommended	Check date code. Keep all cheese tightly packed in moisture proof wrap
Hard Cheese (unopened)	3-4 Months	6 Months	
Hard Cheese (opened)	2 Months	Not recommended	
Cottage Cheese	10-15 Days	Not recommended	
Cream	7-10 Days	2 Months	Check date code. Most yogurt, creams, and similar products are sold in date-coded cartons that indicate a product's peak freshness. Re-seal or cover tightly. Do not return unused portions to original container.
Sour Cream	2 Weeks	Not recommended	
Cream Dips (opened)	1 Week	Not recommended	
Yogurt	10-14 Days	Not recommended	Check date code. Keep covered.
Frozen Yogurt	na	2 Months	
<b>EGGS</b>			
Eggs (uncooked)	3-4 Weeks	Not recommended	Check date code. Store eggs in coldest part of refrigerator and in their original container.
Eggs (cooked)	1 Week	Not recommended	Store in covered container
Leftover egg dishes	3-4 Days	Not recommended	Store in covered container
<b>FRESH FRUITS</b>			
Apples	1 Month	Not recommended	If storing in refrigerator, do not wash fruit before storing. Store in moisture resistant bags or containers. Wrap cut fruits. Some fruits darken when refrigerated.
Bananas	2-4 Days	Not recommended	
Peaches, Melons, Pears, Avocados	3-5 Days	Not recommended	
Berries and Cherries	2-3 Days	12 Months	
Apricots	3-5 Days	Not recommended	
Grapes	2-5 Days	na	
Pineapple (un-cut)	2-3 Days	Not recommended	
Pineapple (cut)	5-7 Days	6-12 Months	
Citrus	1-2 Weeks	Not recommended	Store uncovered.
Juice	6 Days	Not recommended	Check date code and re-seal in original container. Do not return unused portions to original container.
Frozen Juice	Thawing only	12 Months	Check date code. Do not re-freeze.

Foods	Refrigerator	Freezer	Storage Tips
<b>FISH AND SHELLFISH</b>			
<b>Fish</b>			
Fatty Fish (mackerel, trout, salmon)	1-2 Days	2-3 Months	Keep in original wrapper and store in coldest part of refrigerator. Package in vapor-proof and moisture proof wrap for freezer. Freeze at 0 °F (or -18 °C). Thaw in refrigerator or check date code. Freeze in original packaging.
Lean Fish (cod, flounder, etc)	1-2 Days	6 Months	
Frozen or Breaded	na	3 Months	
<b>Shellfish</b>			
Shrimp (uncooked)	1-2 Days	12 Months	To freeze, package in vapor-proof and moisture-proof container.
Crab	3-5 Days	10 Months	
Cooked Fish or Shellfish	2-3 Days	3 Months	
<b>MEAT</b>			
<b>Fresh, Uncooked</b>			
Chops	2-4 Days	6-12 Months	Check date code for use. Store in coldest part of refrigerator in original packaging. Package in moisture-proof and vapor-proof container for freezing. Recommended refrigerator temperature 33 °F to 36 °F (or 1 °C to 2 °C) and freezer temperature 0 °F to 2 °F (or -18 °C to -16 °C)
Ground	1 Day	3-4 Months	
Roast	2-4 Days	6-12 Months	
Bacon	1-2 Weeks	1-2 Months	
Sausage	1-2 Days	1-2 Months	
Steak	2-4 Days	6-9 Months	
Poultry	1 Day	12 Months	
Lunch meat	3-5 Days	1 Month	
<b>Cooked</b>			
Meat	2-3 Days	2-3 Months	Check date code for use. Store in coldest part of refrigerator in original packaging. Package in moisture-proof and vapor-proof container for freezing.
Poultry	2-3 Days	4-5 Months	
Ham	1-2 weeks	1-2 Months	

## Troubleshooting

The refrigerator does not work at all or it does not chill sufficiently.

- Check if the power plug is properly connected.
- Check if the set temperature on the digital display is warmer than the freezer or fridge inner temperature. If it is, set the refrigerator colder.
- Is the refrigerator in direct sunlight or located near a heat source?
- Is the back of the refrigerator too close to the wall, preventing proper ventilation?

The food in the fridge is frozen.

- Check if the set temperature on the digital display is too low.
- Try setting the refrigerator to a warmer temperature

- Is the temperature in the room too low? Set the refrigerator warmer.
- Did you store the food which is juicy in the coldest part of the refrigerator? Try moving those items to the other shelves in the fridge instead of keeping them in the colder areas or bins.

You hear unusual noise or sounds.

- Check if the refrigerator is level and stable.
- Is the back of the refrigerator too close to the wall, preventing proper ventilation? Try moving the back of the refrigerator at least 2 inches from the wall.
- Was anything dropped behind or under the refrigerator?
- A “ticking” sound is heard from inside the refrigerator. This is normal and occurs because various accessories are contracting or expanding according to the temperature of the refrigerator interior.
- If it sounds as if something is hitting something else inside the refrigerator, this is normal. The sound is caused by the compressor operating at high capacity.

The cabinet-door sealing area of the appliance is hot and condensation is occurring.

- Some heat is normal as anti-condensators are installed in the vertical hinged section of the refrigerator to prevent condensation.
- Is the refrigerator door ajar? Condensation can occur when you leave the door open for a long time.

Ice Maker is not producing ice.

- Did you wait for 12 hours after installation of the water supply line before making ice?
- Is the water line connected and the shut-off valve opened?
- Did you manually stop the ice making function?
- Is the freezer temperature too warm? Try setting the freezer temperature lower.

You can hear water bubbling in the refrigerator.

- This is normal. The bubbling comes from refrigerant circulating through the refrigerator

There is a bad smell in the refrigerator.

- Check for spoiled food.
- Foods with strong odors (for example, fish) should be tightly covered.
- Clean out your freezer periodically and throw away any spoiled or suspicious food.

Frost forms on the walls of the freezer.

- Is the air vent blocked? Remove any obstructions so air can circulate freely.
- Allow sufficient space between the stored foods for efficient air circulation.
- Is the freezer drawer closed properly?

Water dispenser is not functioning.

- Is the water line connected and the shut-off valve opened?
- Has the water supply line tubing been crushed or kinked?
- Make sure the tubing is free and clear of any obstruction.
- Is the water tank frozen because the fridge temperature is too low? Try selecting a warmer setting on the Digital display.

Auto close system does not work with the freezer door.

- Is there an imbalance between the right and left parts of the door?
- Open and close the door smoothly 1~2 times. After you do this, the auto close system usually works properly again.
- Try opening the door smoothly to avoid unbalancing the right and the left part of the door.

#### **Warning**

This content is compiled from multiple sources and is provided for reference purposes only. It may not be complete or fully applicable to all situations. If you are unable to resolve your issue, please contact the product manufacturer or an authorized service provider for official support.