

# INTRODUCING YOUR WASHING MACHINE

## Control Panel Features

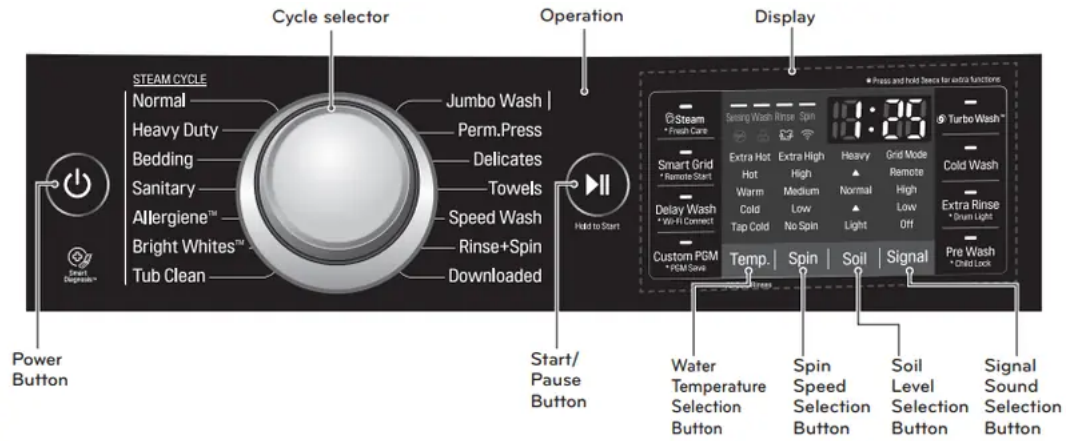

## Operation



Button	Description
	<p>Turns the washing machine on and off.</p> <p>(During the wash cycle) stops operation, and cancels the settings.</p>
	<p>Bright Whites™ For white fabrics (see page 24)</p> <p>Allergiene™ For cotton, underwear (see page 24)</p> <p>Sanitary For underwear, diapers, etc. (see page 24)</p> <p>Bedding For blankets or large bulky items (see page 24)</p> <p>Heavy Duty For heavily soiled cotton fabric (see page 24)</p> <p>Normal For general laundry, such as cotton T-shirts or towels (see page 24)</p> <p>Jumbo Wash For blankets or king size items (see page 24)</p> <p>Perm.Press For wrinkle-free fabrics (see page 24)</p> <p>Delicates For sheer and delicate fabrics (see page 24)</p> <p>Towels For towels (see page 24)</p> <p>Speed Wash For small quantities of lightly soiled items (see page 24)</p> <p>Rinse + Spin For Rinse, drain and Spin only (see page 24)</p> <p>Downloaded</p>



	<p>For downloadable cycles. The default cycle is Small Load. (see page 29).</p> <p>Tub Clean</p> <p>For tub clean (see page 33)</p>
	<p>Starts or pauses the washing machine cycle. Hold a second to Start</p> <p>If you do not press the  button within 1 hour of selecting a cycle, the washing machine will turn off automatically</p>
	<p>(Press repeatedly) Selects the water temperature for the wash cycle (see page 25).</p> <p>Select water temperature from 5 settings.</p>
	<p>(Press repeatedly) Selects the spin speed in the desired level (see page 25).</p> <p>Selects spin speed from 5 settings.</p>
	<p>(Press repeatedly) Selects a wash cycle by soil level (see page 25).</p> <p>Selects soil level from 5 settings.</p>
	<p>(Press repeatedly) Selects a Melody or Button sound by signal(see page 26).</p>
	<p>(Press before starting wash cycle) Use Steam option for extra cleaning power (See page 26).</p> <p>(Press and hold 3 seconds) Fresh Care tumbles clothes to prevent wrinkles (See page 28).</p>
	<p>Use Smart Grid to lower your energy costs by avoiding peak usage times (See page 29).</p> <p>(Press and hold 3 seconds before starting wash cycle) Use Remote Start to control your washer remotely (See page 29).</p>
	<p>(Press before starting wash cycle) Set delay time of starting cycle (See page 27).</p>

	(Press and hold 3 seconds after turning on the machine) Use Wi-Fi Connect for connecting to the internet through your home Wi-Fi network (See page 29).
	Use Custom PGM to recall the customized wash cycle you had previously saved (See page 27).  (Press and hold 3 seconds after setting the desired option) Use PGM Save to save special combination of setting that you use frequently (See page 28).
	Use Turbo Wash™ to save time (See page 27)
	Use Cold Wash to save on energy consumption (See page 27).
	(Press before wash cycle) Add an extra rinse to the selected cycle (See page 27).  (Press and hold during wash cycle) The drum is equipped with a white LED light that illuminates when the washer is turned on (See page 28).
	Pre-wash heavily soiled laundry (See page 27).  (Press and hold 3 seconds during wash cycle) Use the Child Lock option to Lock/ Unlock the controls (See page 30).

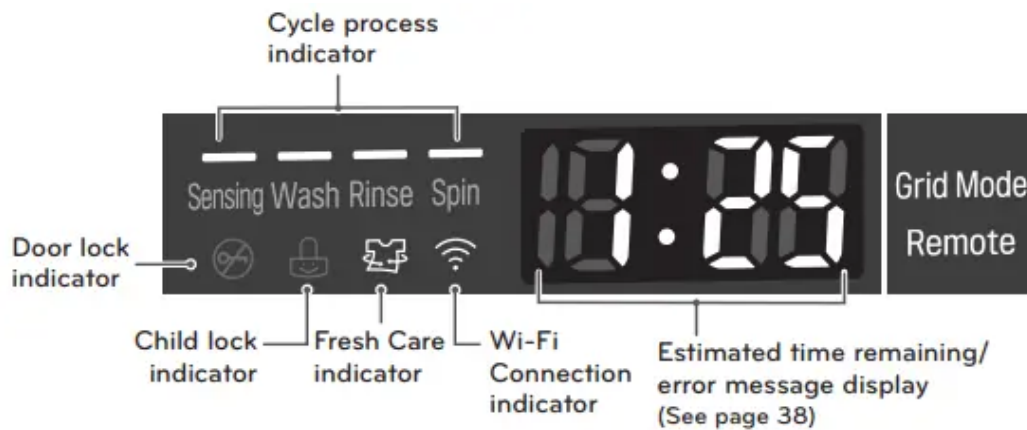

## Display



Display Icon	Description
	This portion of the display shows which stage of the wash cycle is currently underway (Sensing, Wash, Rinse and Spin).
	Indicates that the door is locked. The washer door will lock while the washer is operating. The door can be unlocked by pressing the Start/Pause button to stop the washer.
	When Child Lock is set, the Child Lock indicator appears and all buttons are disabled except the Pre Wash button. This prevents children from changing settings while the washer is operating.
	This indicator shows that the washer has been set for Fresh Care. This function provides periodic tumbling for up to about 19 hours to prevent wrinkles.
	When the appliance is connected to the internet through a home Wi-Fi network, this indicator appears.
	When the Start/Pause button is pressed, the washer automatically detects the wash load (weight) and optimizes the washing time, based on the selected cycle and options. The display will then indicate the estimated time remaining for the selected wash cycle.
	When the Smart Grid signal is detected, this indicator appears.
	When the Remote Start mode is activated, this indicator appears.

## USING YOUR WASHING MACHINE

### Basic operation

1		Load the laundry into the washing machine and close the door.
2		<p>Press .</p> <ul style="list-style-type: none"> <li>- The lights around the cycle selector knob will illuminate and a chime will sound.</li> </ul>
3		<p>Turn  to the desired cycle.</p> <ul style="list-style-type: none"> <li>- The proper default option is automatically set according to the wash cycle. See page 23, Cycle guide, for more detailed default options for each cycle.</li> <li>- See page 24, Main cycle, for details on the wash cycles.</li> <li>- To change the options, press the option button and select the desired option. See page 26, Setting options before cycle, for more details on options.</li> <li>- Skip to step 4 to use the default setting without changing the options.</li> </ul>
4		<p>Add the proper amount of detergent and additional products (bleach, softener) into the dispensers.</p> <ul style="list-style-type: none"> <li>- See page 20, Using detergent/fabric softener, for more details on using detergent.</li> </ul>
5		<p>Press .</p> <ul style="list-style-type: none"> <li>- The washing machine starts.</li> </ul>
6		<p>When the melody plays, the wash cycle is finished.</p> <ul style="list-style-type: none"> <li>- When the washing cycle is finished, the door unlocks. Open the door and remove the laundry immediately.</li> <li>- Make sure to check around the door seal when taking out the finished load. Small items may be caught in the door seal.</li> </ul>

**WARNING** To reduce the risk of fire, electric shock, or injury to persons, read the IMPORTANT SAFETY INSTRUCTIONS before operating this appliance.

## NOTE

- The front-load washing machine rotates the laundry in a way that allows it to use less water while still fully saturating your clothing. It is normal to not be able to see water during the wash cycle.
- If the temperature or the water level inside the machine is too high, the door locks and cannot be opened. To open the door while washing, use the Rinse + Spin feature.

## Main cycle

You can wash laundry items more thoroughly by selecting the wash cycle that best suits the type of items to be washed. Turn the  to the desired cycle. When you select a wash cycle, the light for the corresponding wash cycle will turn on. See page 22, Basic operation, for more details on operating methods.

### For white fabrics, Bright Whites™

This cycle is for washing white items only.

### Reduce laundry allergen, Allergiene™

This cycle is a powerful, high temperature cycle designed specifically to reduce certain allergens.

## NOTE

- Selecting the Allergiene™ cycle automatically incorporates steam into the wash cycle.
- The Allergiene™ cycle can significantly reduce allergens in bedding and clothing.
- The Allergiene™ cycle helps reduce dust mite populations and helps reduce allergens.
- Due to the higher energy and temperatures used, the Allergiene™ cycle is not recommended for wool, silk, leather, or any other delicate or temperature sensitive items.

### Reduce laundry bacteria, Sanitary

This wash cycle reduces 99% of bacteria on laundry through high temperature.

**NOTE** This cycle has been certified by NSF using Tide HE powder.

### Blankets or bulky items, Bedding



This cycle is for washing blankets or bulky items.

### Heavily soiled items, Heavy Duty

This cycle is for washing heavily soiled laundry through more powerful tub rotation.

### Normal items, Normal

Use this cycle to wash all normal items, except delicate fabrics such as wool or silk.

**NOTE** If you press  and then  without selecting another cycle, the washing machine proceeds to Normal.

### **Comforters, Jumbo Wash**

This cycle is for washing king or queen comforter.

### **Wrinkle free items, Perm.Press**

This cycle is for washing items such as wrinkle-free clothes or tablecloths to minimize wrinkles.

### **Sheer items, Delicates**

This cycle is for washing lingerie or sheer and lacy clothes which can easily be damaged.

### **For towels, Towels**

This cycle is for washing towels.

### **Quick wash, Speed Wash**

Use the Speed Wash cycle to quickly wash lightly soiled clothing and small load. For high wash and rinse efficiency, it is recommended to wash small loads of 2-3 lightly soiled garments.

**NOTE** Use very little detergent in this cycle. If you want more rinsing, you can add an extra rinse by using the Extra Rinse option button.

### **Rinse, drain and spin only, Rinse + Spin**

This cycle is for rinsing detergent from the load.

### **Downloading cycles, Downloaded**

For downloadable cycles. The default cycle is Small Load. (See page 29.)

### **Cycle modifier buttons**

Each cycle has preset settings that are selected automatically. You may also customize the settings using the cycle modifier buttons. Press the button for that option to view and select other settings. The washer automatically adjusts the water level for the type and size of wash load for best results and maximum efficiency. It may seem there is no water inside the drum in some cycles, but this is normal.

**NOTE** To protect your garments, not every wash/rinse temperature, spin speed, soil level, or option is available with every cycle. See the Cycle Guide for details.

### **Setting the water temperature, Temp.**

Set the water temperature for the wash cycle. Set the appropriate temperature, as specified in the fabric care label.

1 Press  and turn  to the desired cycle.

2 Press  repeatedly to select the desired water temperature: - When an optional item is selected, an indication light for the corresponding optional item turns on.

3 Press the desired option button to use the other options.

- Skip to step 4 to use the default setting without changing the options.

4 Press .

#### NOTE

- Cold rinses use less energy.
- Your washer features a heating element to boost the hot water temperature for Extra Hot settings. This provides improved wash performance at normal water heater settings.
- Select the water temperature suitable for the type of load you are washing. Follow the fabric care label for best results.

#### Setting spin speed, Spin

You can set the desired spin speed. Use this feature properly according to the characteristics of the load.

1 Press  and turn  to the desired cycle.

2 Press  repeatedly to select the desired spin speed.

- When an optional item is selected, an indication light for the corresponding optional item turns on.

3 Press the desired option to use the other options.

- Skip to step 4 to use the default setting without changing the options.

4 Press .

#### NOTE

- The Spin button also activates the Drain&Spin cycle to drain the tub and spin clothes; for example, if you want to remove clothes before the cycle has ended.
- To use Drain&Spin, press the Power button, then press the Spin button repeatedly to select a spin speed.

Press the Start/Pause button to begin.

#### Setting soil level of laundry, Soil

You can wash your laundry more thoroughly by setting the proper soil level on the washing machine.

1 Press  and turn  to desired cycle.

2 Press  repeatedly to select a soil level.

- When an optional item is selected, an indication light for the corresponding optional item turns on.

3 Press the desired option to use the other options.

- Skip to step 4 to use the default setting without changing the options.

4 Press .

**NOTE** This feature needs more time for heavily soiled loads or less time for lightly soiled loads.

### **Adjusts the melody and button tones, Signal**

The washing machine plays a melody when the wash cycle is finished. The buttons make a sound each time a button is pressed. The volume of the melody and button tones can be changed or turned off as desired.

1 Press .

2 Turn  to the desired cycle.

3 Press . Adjust the melody and button tones as desired.

4 Press the desired option to use the other options.

5 Press .

### **Setting options before cycle**

You can select and add the desired optional functions before you start the washing machine.

#### **High temperature, Steam**

Adding the Steam option to these cycles helps to enhance washing performance. By using hot steam fabrics get the cleaning benefits of a super hot wash.

1 Press  and turn  to the desired cycle.

2 Press . The washer will automatically adjust the cycle settings.

3 Set any other desired options.

4 Press .

## WARNING

- Do not touch the door during steam cycles. The door surface can become very hot. Allow the door lock to release before opening the door.
- Do not attempt to override the door lock mechanism or reach into the washer during a steam cycle. Steam can cause severe burns.

## NOTE

- The steam option cannot be used with all cycles.
- Steam may not be clearly visible during the steam cycles. This is normal. Too much steam could damage clothing.
- Do not use steam with delicate fabrics such as wool, silk, or easily discolored fabrics.

## Presetting the start time, Delay Wash

Set the desired start time.

1 Press  and turn  to the desired cycle.

2 Press the desired option to use the other options.

3 Press  repeatedly to select the desired start time.

-  light will turn on.

- The set start time appears on the display panel.



- Each press of the button increases the delay time by one hour, up to 19 hours.

4 Press .

## Selecting your customized cycle, Custom PGM

Recall a customized wash cycle that was previously saved.

To recall a cycle

1 Press  after then press .

2 Press . You can save a cycle with all the settings and options you use most frequently.

## Saving time, Turbo Wash™

Adding the Turbo Wash™ option reduces cycle time and provides good performance in normal cycle. Using Turbo Wash™ saves time without sacrificing performance.

1 Press  and turn  to the desired cycle.

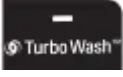
2 Press . The washer will automatically adjust the cycle settings.

3 Set any other desired options.

4 Press .

#### NOTE

- The Turbo Wash™ option cannot be used with all cycles.
- The option is selected by default on the Normal, Heavy Duty, and Perm. Press cycles.

#### Saving energy, Cold Wash

Adding the Cold Wash option reduces energy usage and provides the same washing performance as a warm water wash.

By using 6 different washing motions (Tumbling, Rolling, Stepping, Scrubbing, Swing, Filtration), fabrics get the cleaning benefits, without the energy usage.

1 Press  and turn  to the desired cycle.

2 Press . The washer will automatically adjust the cycle settings.

3 Set any other desired options.

4 Press .

#### NOTE

- When you select the Cold Wash option, wash time will be increased up to 5 - 20 minutes.
- For high wash efficiency, it is recommended to use less than 8 pounds.

#### Adding extra rinse cycle, Extra Rinse

Add an extra rinse cycle to the default rinse cycle.

1 Press  and turn  to the desired cycle.

2 Press .

-  light will turn on.

3 Press the desired option to use the other options.

- Skip to step 4 to use the default setting without changing the options.

4 Press .

#### Prewashing, Pre Wash

Pre-wash for 15 minutes when clothes are covered in dirt or dust. This feature is suitable for heavily soiled items.

1 Press  and turn  to the desired cycle.

2 Press .

-  light will turn on.

3 Press the desired option to use the other options.

- Skip to step 4 to use the default setting without changing the options.

4 Press .

### Setting the options during cycle

Add the desired options during the wash cycle.

#### Tumble clothes to prevent wrinkles, Fresh Care

Use this function when you are not able to take out your clothes as soon as the wash cycle ends.

1 Press  and turn  to the desired cycle.

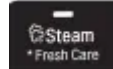
2 Press and hold  for 3 seconds during the wash cycle.

-  light will turn on.

3 Select any desired options.

- Skip to step 4 if you would like to use the default settings without changing or adding any options.

4 Press .

**NOTE** This function provides periodic tumbling for up to about 19 hours to prevent wrinkles. If you press the START/ PAUSE or ON/ OFF button, you can unload your laundry at anytime.

#### Saving customized wash cycle, PGM Save

Save a special combination of settings that are used frequently.

To save a cycle

1 Press  and turn  to the desired cycle.

2 Press the desired option to use the other options.

3 Press and hold  for 3 seconds during the wash cycle.

- The cycle with your preferred settings and options is saved.

### Drum Lighting, Drum Light

The drum is equipped with a white LED light that illuminates when the washer is turned on. This light automatically turns off when the door is closed and the cycle starts. To turn on the light during a cycle.

1 Press  and turn  to the desired cycle.

2 Press .

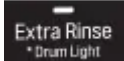
3 Press and hold  for 3 seconds during the wash cycle.

- The drum light will illuminate and then turn off automatically after 4 minutes.
- Clothes and the gasket may look like yellow due to lights of the lamp, but it is normal.

### Button lock feature, Child Lock

Lock the washing machine to prevent children or others from changing the cycle settings by pressing the buttons during the cycle.

To enable child lock

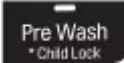
Press and hold  for 3 seconds during the wash cycle.

- When the Child Lock is enabled, a  message and the remaining wash time are displayed, in turn, on the display panel of the washing machine.

To disable child lock

(When the Child Lock is activated.)

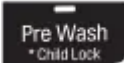
Press and hold  for 3 seconds during the wash cycle.

**NOTE** Child Lock lasts after the end of cycle. If you want to deactivate this function, Press and hold the Pre Wash button for 3 seconds.

## SMART FUNCTIONS

### LG SmartThinQ Application

The LG SmartThinQ application allows you to communicate with the appliance using a smartphone.

### Installing LG SmartThinQ Application

Search for the LG SmartThinQ application from the Google Play Store or Apple App Store on a smart phone. Follow instructions to download and install the application.

### Installing LG SmartThinQ Application



- For appliances with the SmartThinQ or SmartThinQ™ logo

### Washer Cycle (Remote Start + Downloaded)

Set or download any preferred cycle and operate by remote control.

### Tub Clean Coach

This function shows how many cycles remain before it is time to run the Tub Clean cycle.

### Smart Diagnosis™

This function provides useful information for diagnosing and solving issues with the appliance based on the pattern of use.

### Energy Monitoring

The washer energy usage is affected by the cycles and options so you may see some changes in energy usage from one cycle to another.

### Push Alerts

When the cycle is complete or the appliance has problems, you have the option of receiving push notifications on a smart phone.

### Settings

Set the product nickname and delete product.

### NOTE

- To verify the Wi-Fi connection, check that Wi-Fi  icon on the control panel is lit.
- LG SmartThinQ is not responsible for any network connection problems or any faults, malfunctions, or errors caused by network connection.
- The machine supports 2.4 GHz Wi-Fi networks only.
- If the appliance is having trouble connecting to the Wi-Fi network, it may be too far from the router. Purchase a Wi-Fi repeater (range extender) to improve the Wi-Fi signal strength.
- The Wi-Fi connection may not connect or may be interrupted because of the home network environment.
- The network connection may not work properly depending on the internet service provider.
- The surrounding wireless environment can make the wireless network service run slowly.

- This information is current at the time of publication.
- The application is subject to change for product improvement purposes without notice to users.

## Using Washer Cycle

### Remote Start

Use a smart phone to control the appliance remotely or check to see how much time is left in the cycle.

### Using Remote Start

- 1 Press the Power button.
- 2 Load the laundry.
- 3 Press and hold Remote Start button for 3 seconds to enable the Remote Start function.
- 4 Start a cycle from the LG SmartThinQ application on your smart phone.

### NOTE

- Once the Remote Start mode is enabled, you can start a cycle from the LG SmartThinQ smartphone application. If the cycle is not started, the machine will wait to start the cycle until it is turned off remotely from the application or the Remote Start mode is disabled.
- When Remote Start is turned on, the door is automatically locked.

## MAINTENANCE

### Care

#### Care after wash

After the cycle is finished, wipe the door and the inside of the door seal to remove any moisture. Leave the door open to dry the washer tub interior. Wipe the body of the washing machine with a dry cloth to remove any moisture.

#### Care in cold climates

Storing the washing machine for an extended period of time

Follow the instructions for storing the washing machine if you do not use it for an extended period of time in cold climates below freezing point.

- 1 Turn off the faucets connected with the water lines.
- 2 Unscrew the water lines from back of the washer.

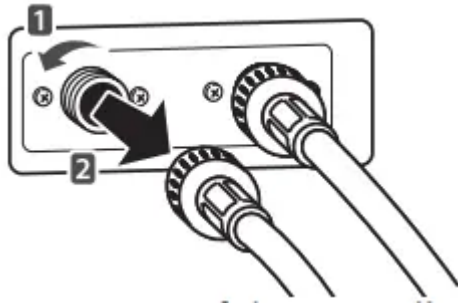

3 Empty any water out of the water lines.

4 Press .

5 Open the door and add 1 gallon (3.8 L) of nontoxic recreational vehicle (RV) antifreeze to the empty washer tub. Close the door.

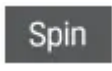
6 Press  for draining and spinning.

7 Press .

8 Press  to turn off the washing machine and pull out the power plug.

9 Dry the tub interior of the washer tub with a soft cloth, and close the door.

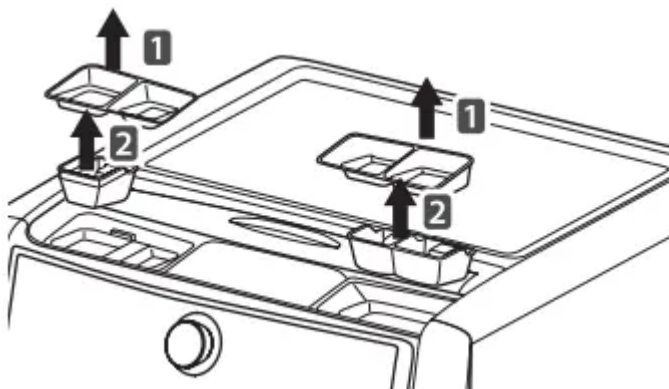

10 Slide back the top cover. Remove the detergent dispenser covers and pull out the liquid detergent cups.

11 Drain the water from the detergent dispenser and dry out each compartment.

12 Store the washing machine in an upright position.

**NOTE** To remove the antifreeze after storing the washing machine, add detergent to the dispenser, and run one cycle. Do not load any laundry at this time.

When the water line is frozen

1 Turn off the faucets connected with the water lines.

2 Pour hot water on the frozen faucets to thaw the water lines and pull them out.

3 Immerse the water lines in hot water to thaw them.

4 Connect the water lines with the water inlets of the washing machine and faucets.

- See page 14, Connecting the water lines for details.

5 Turn on the faucets.

6 Press .

7 Press .

8 Press .

- Verify the water fills properly.

#### When the Drain Line is Frozen

1 Pour hot water in the washer tub and close the door.

- Leave it for 10 minutes.

2 Press  after 10 minutes.

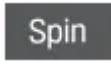
3 Press  for draining and spinning.

4 Press .

- Check if the water drains.

## Cleaning

Periodically clean the washing machine to help maintain its performance and to minimize the chance of malfunction.

### Cleaning the drum, Tub Clean

Improper installation or use of the washing machine in a humid space for a long period of time potentially could lead to a buildup of detergent residue in the washing machine that may produce mildew or musty smells. If you clean the washer tub regularly on a monthly basis using Tub Clean it will minimize the possibility that detergent residue will build up and mildew or musty smells may occur.

1 Add tub cleaner or lime scale remover into the detergent dispenser.

- Do not exceed the maximum detergent limit line when you add it. Detergent may remain in the washer tub after cleaning.

- When you use liquid chlorine bleach, load it into the liquid chlorine bleach compartment.

- When you use a powdered cleaner, pull out the liquid detergent cup and add it into the main wash detergent compartment.

- When you use cleaning tablets, place them directly into the washer tub. (Do not add tablet cleaner to the dispenser.)

2 Press .

3 Turn  to Tub Clean.

- *tc* message appears in the display.

- The indication light for Tub Clean turns on.

4 Press .

## NOTE

- Never load laundry while using Tub Clean. The laundry may be damaged. Make sure to clean the washer tub when it is empty.
- It is recommended to leave the door open after finishing the laundry to keep the tub clean.
- It is recommended that Tub Clean should be repeated monthly.
- If you notice mildew or musty smells, run Tub Clean for 3 consecutive weeks.

## Cleaning the water inlet filters

Clean the water inlet filters periodically to prevent clogging. Take extra care to clean the water inlet filters for areas using hard water. Water may not be supplied if there are foreign objects, such as rust, sand, or stones in the water inlet filters.

1 Press  to turn off the washing machine and pull out the plug.

2 Turn off the faucets connected with the water inlets.

3 Remove the water inlets.

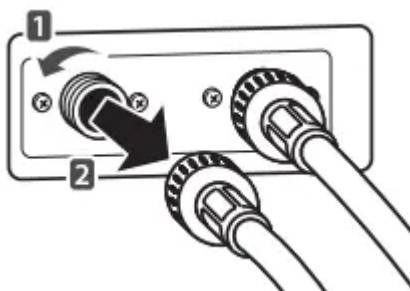

4 Pull out the water inlet filter.

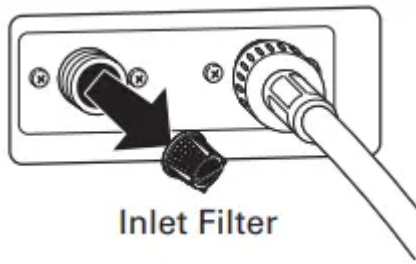

5 Remove foreign objects from the water filter inlet.

- Soak the water filter inlets in white vinegar or a lime scale remover or use a toothbrush to remove foreign objects and rinse thoroughly.

6 Press the water filter inlets back into place.

7 Reattach the water lines to the washing machine.

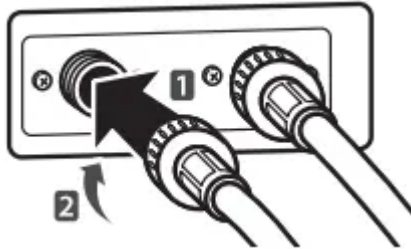

### Cleaning the drain pump filter

The washing machine fails to drain if the drain pump filter is clogged. Periodically clean the drain filter to prevent clogging with foreign objects.

1 Press  to turn off the washing machine and pull out the plug.

2 Open the drain pump filter cover.

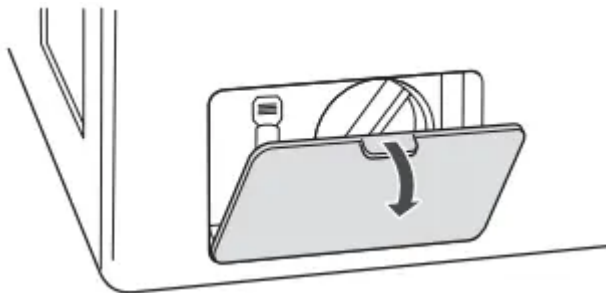

3 Unclip the drain hose and remove the plug from the drain hose to drain the remaining water.

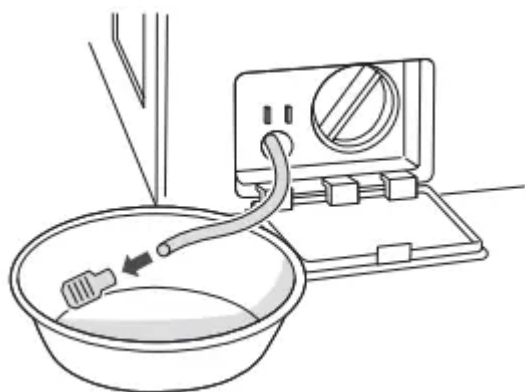

4 Twist the pump filter counterclockwise to remove.



5 Clean the pump filter and opening.

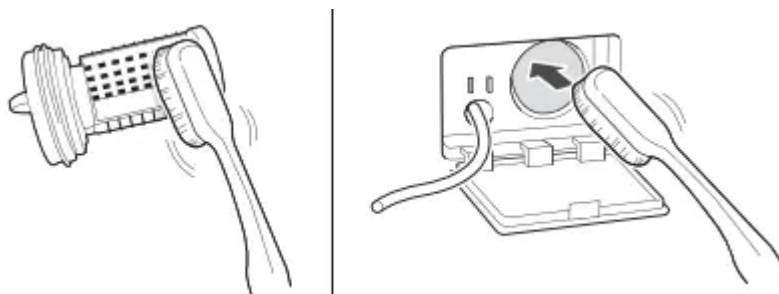

6 Recap the plug onto the drain hose and reattach the drain hose.

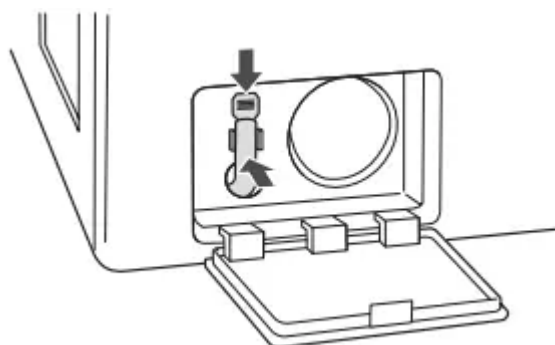

7 Insert the drain pump filter.

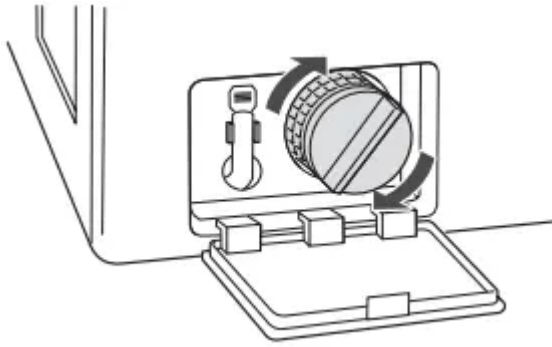

8 Close the drain pump filter cover.

### **WARNING**

- Make sure to pull out the plug before cleaning. Failure to do so may cause electric shock.
- Opening the drain filter will result in water overflowing if there is water in the washer tub. Make sure to check if the water is completely drained before opening the drain filter.
- If you use the washing machine with the drain filter reassembled incorrectly after cleaning it, or if you use the machine without the filter, it may cause leaks or malfunction of the washing machine.

**NOTE** An **DE** message blinks when the drain pump filter is clogged with dirt. Clean the drain pump filter.

### **Cleaning the door seal**

Clean the door seal once a month to prevent buildup of dirt in the door seal.

- 1 Wear rubber gloves and protective goggles.
- 2 Dilute 3/4 cup (177 ml) of liquid chlorine bleach in 1 gallon (3.8 L) of water.
- 3 Soak a sponge or a soft cloth in this diluted solution and wipe down all around the door seal.
- 4 Wipe any moisture with a dry towel or cloth after cleaning.
- 5 Leave the door open to allow the door seal to dry completely.

**CAUTION** Cleaning the door seal with undiluted bleach may cause malfunction of the door seal and washing machine parts. You must add water to the bleach before using it.

## **TROUBLESHOOTING**

### **Checking error messages**

If the following message appears on the display, check the following and take the appropriate corrective action.

Message	Possible Causes	Solutions
	<p>Item of clothing has gathered on one side of the tub.</p> <ul style="list-style-type: none"> <li>• There are not enough items in the machine.</li> <li>• Have your items gathered in one area, or is the load too small?</li> <li>• Did you wash a stuffed animal, a mat, or knitwear?</li> <li>• Did you wash two different blankets together?</li> </ul>	<ul style="list-style-type: none"> <li>• Rearrange items to help balance the load.</li> <li>• Stuffed animals or mats can become unbalanced during spinning and the washing machine may fail to drain. Rearrange the knitwear to help balance the load and drain it again.</li> <li>• Put one blanket in at a time.</li> </ul>
	<p>Water is not supplied or the water pressure is low</p> <ul style="list-style-type: none"> <li>• Is the faucet turned off?</li> <li>• Is the water supply stopped or the faucet frozen?</li> <li>• Is the water pressure low or is an inlet filter clogged?</li> <li>• Is the water line properly connected with the cold water inlet?</li> <li>• Is the water line pinched or bent?</li> </ul>	<ul style="list-style-type: none"> <li>• Turn on the faucets.</li> <li>• If a faucet is frozen, thaw it with warm water.</li> <li>• If the inlet filter is clogged, clean it. (see page 35)</li> <li>• Connect the water line properly with the cold water inlet. (see page 14)</li> <li>• Check that the water lines are not pinched or bent. Take extra care that water lines are not twisted or pinched by other objects.</li> </ul>
	<p>Water line leaks in connection</p> <ul style="list-style-type: none"> <li>• Are the water lines connected with the faucets properly?</li> </ul>	<ul style="list-style-type: none"> <li>• Connect the water lines properly with the faucets. (see page 14)</li> </ul>



	<p>The tub does not rotate</p> <ul style="list-style-type: none"> <li>• Is the door secured?</li> </ul>	<ul style="list-style-type: none"> <li>• Close and secure the door. If the message keeps appearing, unplug the power and contact your nearest LG service center.</li> </ul>
	<p>The washing machine drains slowly or not at all</p> <ul style="list-style-type: none"> <li>• Is the drain hose installed over 3 1/4 feet (1 m) beyond the end of the elbow bracket?</li> <li>• Is the drain hose pinched or clogged inside?</li> <li>• Is the drain hose frozen?</li> <li>• Is the drain hose clogged with foreign objects?</li> </ul>	<ul style="list-style-type: none"> <li>• Lower the drain hose within 3 feet below the end of the elbow bracket.</li> <li>• Place the drain hose on a smooth surface to prevent bending.</li> <li>• If the drain hoses are frozen, thaw them in warm water.</li> <li>• Open the drain pump plug cap and remove the dirt.</li> </ul>
	<p>A power failure has occurred.</p>	<ul style="list-style-type: none"> <li>• Press  to turn off the washing machine and press it again to turn it on.</li> </ul>
	<p>Control Error.</p>	<ul style="list-style-type: none"> <li>• Unplug the power cord and contact your nearest LG service center.</li> </ul>
	<p>The water supply does not stop</p> <ul style="list-style-type: none"> <li>• Do the water supply and the drain keep repeating in turn?</li> </ul>	<ul style="list-style-type: none"> <li>• Unplug the power cord and contact your nearest LG service center.</li> </ul>

	<p>The water level is not controlled</p> <ul style="list-style-type: none"> <li>• Is the water level too low or high compared with the size of the load?</li> </ul>	<ul style="list-style-type: none"> <li>• The water level sensor is not working correctly.</li> <li>• Unplug the power cord and contact your nearest LG service center.</li> </ul>
	<p>The tub does not rotate</p> <ul style="list-style-type: none"> <li>• Is the washing machine overloaded?</li> </ul>	<ul style="list-style-type: none"> <li>• Rearrange the load size and restart the washing machine.</li> <li>• If the load size is big, the tub may not rotate due to an overheated motor. Allow the washing machine to stand for a while and restart the cycle. Unplug the power cord and contact your nearest LG service center if the same error message appears.</li> </ul>
	<ul style="list-style-type: none"> <li>• Time to run the Tub Clean cycle.</li> </ul>	<ul style="list-style-type: none"> <li>• Empty the tub, insert bleach into the detergent dispenser and select the Tub Clean cycle.</li> <li>• To skip the Tub Clean cycle, turn the cycle selector knob or push option buttons to select desired cycle. The reminder message reappears for a few wash cycles then disappears until the next scheduled tub clean cycle.</li> </ul>



	<ul style="list-style-type: none"><li>• If the washing machine detects too many suds, it displays this error code and adds a Suds Reducing cycle. This adds about two hours to the cycle time. If too many suds are detected during spinning, the washing machine stops to help prevent leaking.</li></ul>	<ul style="list-style-type: none"><li>• Do not add more than the manufacturer's recommended amount of detergent.</li></ul>
--	--	--

### **Before calling for service**

Check the following before calling for service.



<b>Problem</b>	<b>Possible Causes</b>	<b>Solutions</b>
Clicking sound	Do you hear a sound when you close or lock and unlock the door?	This sound is normal and occurs when the door is closed, locked or unlocked.
Spraying or hissing sound	Is water spraying in the tub?	This sound is normal as water is spraying or circulating during the cycle.
Buzzing or gushing sound	Is the washing machine draining water?	This sound is normal as the drain pump drains water from the washing machine after the cycle.
Splashing sound	Is the washing machine washing a load of laundry?	This sound is normal as the load is moving up and down during the wash and rinse cycles.
Rattling and clanking noise	Are there any foreign objects such as keys, coins, or safety pins in the tub or drain filter?	Check if there are any foreign objects in the tub and drain the filter after stopping the cycle.  Unplug the power cord and contact your nearest LG
Thumping sound	Is the washing machine overloaded?  Is the load out of balance?	This sound is normal and occurs when the load is out of balance. Stop the cycle and rearrange the load for balancing.
Vibrating noise	<ul style="list-style-type: none"> <li>• Are the shipping bolts removed?</li> <li>• Is the load evenly distributed in the tub?</li> <li>• Is the washing machine level balanced?</li> <li>• Is the washing machine installed on a solid and smooth surface?</li> </ul>	<ul style="list-style-type: none"> <li>• See page 13, Unpacking and removing shipping bolts to remove the shipping bolts.</li> <li>• Stop the cycle and rearrange the load for balancing.</li> <li>• See page 16, Leveling the washing machine to level the washing machine.</li> <li>• Check if the floor is solid and level.</li> </ul>

<p>Water leaking around washer</p>	<p>Does water leak from a faucet or a water line?</p> <p>Is a drain pipe or a drain hose clogged?</p>	<p>Check the faucets or water lines.</p> <p>- If the water lines are loosely connected, see page 14, Connecting water lines to connect them properly.</p> <p>Unclog the drain pipe or drain hose. Contact a plumber if necessary.</p>
<p>Excessive suds or failure to rinse</p>	<p>Did you use more than the recommended amount of detergent?</p> <p>Is the soil level higher than the size of the load?</p>	<p>Use the recommended amount of detergent for load.</p> <p>If the contamination level is low, reduce the detergent quantity to less than the recommended level.</p> <p> Only use detergent with the HE (High-Efficiency) logo.</p>
<p>Staining</p>	<ul style="list-style-type: none"> <li>• Did you add detergent directly to the tub?</li> <li>• Did you remove the load immediately after it finished?</li> <li>• Did you sort and wash the clothes by color or soil?</li> </ul>	<ul style="list-style-type: none"> <li>• Make sure to load detergent into the detergent dispenser.</li> <li>• Remove the load immediately after it finishes.</li> <li>• Sort and separate dark colors from light or white ones, and heavily soiled items from lightly soiled ones. See page 19, Sorting laundry for details.</li> </ul>
<p>Wrinkling</p>	<ul style="list-style-type: none"> <li>• Did you remove the load immediately after it finished?</li> <li>• Did you overload the tub?</li> <li>• Did you reverse the hot and cold water inlets?</li> </ul>	<ul style="list-style-type: none"> <li>• Remove the load immediately after it finishes.</li> <li>• Do not overload the tub.</li> <li>• Hot water rinse can cause garments to wrinkle. Check the inlet hose connections.</li> </ul>

<p>Power is not turned on</p>	<p>Is the power cord plugged in properly?</p> <p>Has a house fuse blown, a circuit breaker tripped, or a power outage occurred?</p>	<p>Make sure that the plug is secured in a grounded 3-prong, 120 V (60 Hz) outlet.</p> <p>Reset the circuit breaker or replace the fuse. Do not increase the fuse capacity. If the problem is a circuit overload, have it corrected by a qualified electrician.</p>
<p>The door does not open when the cycle pauses or finishes</p>	<p>Is the temperature in the tub too high?</p> <p>Is the water level in washer high?</p>	<p>The washing machine has a safety lock built into the door to prevent burning. Leave the door closed and wait until the door lock icon disappears from the display.</p> <p>Allow the washer to complete the programmed cycle, or Press the Spin button.</p>
<p>The wash cycle time is longer than usual</p>	<p>Is the washing machine overloaded? Are other options added to the wash cycle?</p>	<p>This is normal. The washing machine automatically adjusts the cycle time for the amount of laundry, water pressure, water temperature, and other operating conditions.</p>
<p>It is musty or moldy in the tub</p>	<p>Has the incorrect detergent been used?</p> <p>Did you clean the tub periodically?</p>	<p>Use only HE (High-Efficiency) detergent recommended for a front-loading washing machine.</p> <p>See page 33, clean the inside and outside of the washing machine periodically.</p>
<p>Banging noise when washer is filling with water (Water Hammer)</p>	<p>Plumbing in the home moves or flexes when the water valves in the washer shut off.</p> <p>Household water supply pressure is very high.</p>	<p>Water hammer is not caused by a defect in the washer. Install water hammer arrestors (purchased separately at hardware or home improvement store) between the fill hose and the washer for best results.</p>



		Adjust household water supply regulator to a lower pressure or contact a plumber to have a regulator installed.
Odor	<ul style="list-style-type: none"> <li>• This odor is caused by the rubber attached to the washing machine.</li> <li>• If the rubber door gasket and door seal area are not cleaned regularly, odors can occur from mold or foreign substances.</li> <li>• Odors can occur if foreign substances are left in the drainage pump filter.</li> <li>• Odors can occur if the drainage hose is not properly installed, causing siphoning (water flowing back inside the washing machine).</li> <li>• Using the dry function, odors can occur from lint and other laundry matter sticking to the heater. (Dryer model only)</li> <li>• A particular odor can occur from drying wet clothes with hot air. (Dryer model only)</li> </ul>	<ul style="list-style-type: none"> <li>• It is the normal odor of new rubber and will disappear after the machine has been run a few times.</li> <li>• Be sure to clean the gasket and door seal regularly and check under the door seal for small items when unloading the washer.</li> <li>• Be sure to clean the drainage pump filter regularly.</li> <li>• When installing the drainage hose, be sure that it doesn't become kinked or blocked.</li> <li>• This is not a malfunction.</li> <li>• The odor will disappear after a short while.</li> </ul>

**Warning**



This content is compiled from multiple sources and is provided for reference purposes only. It may not be complete or fully applicable to all situations. If you are unable to resolve your issue, please contact the product manufacturer or an authorized service provider for official support.

---

Document generated by [ManualsFile](#)

