

Display area

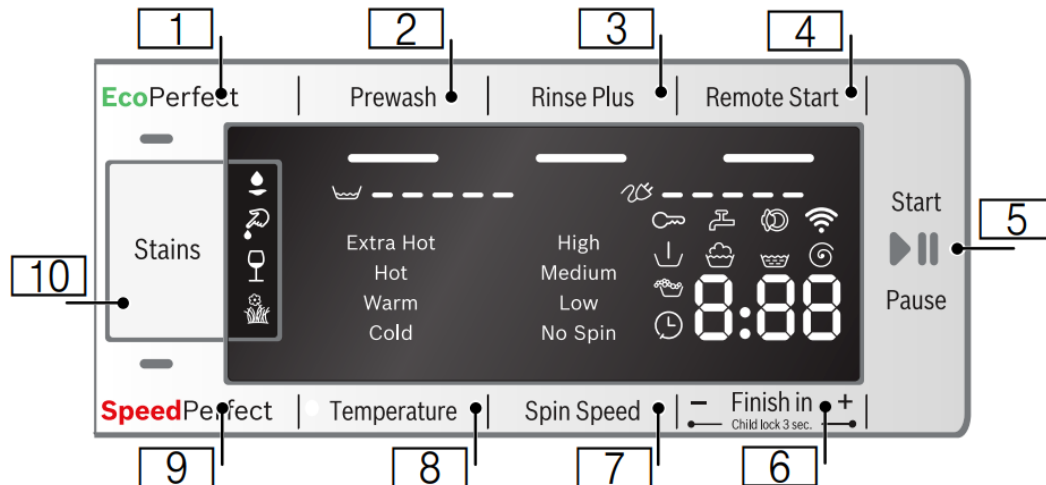

Buttons

Indicator	Description
	Lit: Child lock activated Flashing: A change to the programs or options is not allowed because Child lock is activated. Flashing will stop after a few seconds.
	Flashing: Tap not turned on, no water pressure
	Lit: The appliance door can be opened. Flashing: Door locking or unlocking is ongoing.
	OFF: Wi-Fi is off. Flashing: The appliance is trying to connect to your home network or broadcasting "Home Connect" hot-spot. Lit: Wi-Fi is on and the appliance is connected to your home network.
Information on energy and water consumption:	
	Water consumption display
	Energy consumption display
Information on energy and water consumption:	
	Water consumption display
	Energy consumption display
Washing cycle status sequence:	
	Prewash
	Wash
	Rinse
	Spin
e.g. 1:40	Expected program duration in hours and minutes
-P-	Pause Shown when Start/Pause button is pressed on control panel, Pause is activated from App.
-E-	Program end
Further information:	
	Lit: Excess foam detected
e.g. E:00 <-> -00	Fault display
e.g. H:00	Hint display

Operating Instructions

Before using the washer for the first time

Check to make sure your washer has been installed properly by following the installation instructions in this manual.

→ Installation instructions; Page 12

Check the machine. Never connect the utilities (power or water) to or start a damaged machine! Contact Customer Service!

Check to be sure your household electrical system voltage and the voltage specifications on the washing machine rating plate correspond. Check to be sure the washer's hot and cold water supply taps are turned on.

Turning the washing machine on and off

Center of the program selector is pressed to turn the appliance on or off.

Before loading your first load of laundry

Your new washing machine was tested before leaving the factory. This process involves running various wash cycles. As a result, a small amount of water may remain in the tub and drainage system. Run a Drum Clean cycle with no laundry to clean the system before your first load of laundry.

First add 1 to 2 tablespoons of detergent to the mainwash chamber II. Then run the Drum Clean cycle.

Wait for the cycle to finish.

Using the program selector to choose a wash program

NOTICE: If the Child lock is activated, you must deactivate it before you can select a program.

→ Child lock; Page 37

Use the program selector to select the desired wash program. The dial turns in both directions and when a cycle is selected its time duration appears in the display. The related preset options (temperature, spin speed, etc.) lights are activated.

Selecting optional program settings

By selecting the optional program settings, you can adjust the washing process to better suit the items you are washing.

The optional program settings can be selected and/or deselected depending if they are allowed (not all settings are allowed for all programs) and the cycle's progress.

The indicator lamps of the buttons light up if the setting is active.

→ Program selection table; Page 34

→ Optional program settings; Page 36

Loading the laundry

Loosen the laundry being loaded and mix small and large items

Unfold the sorted items and place them loosely in the drum. Mix small and large items to help them better distribute in the drum during the spin cycle.

Tip: Do not exceed the maximum load recommended for the type of wash. Overloading will cause poor wash results and will cause wrinkles.

Recommended Load Size

Recommended maximum load size can be found:

→ Standard features and helpful information; Page 9

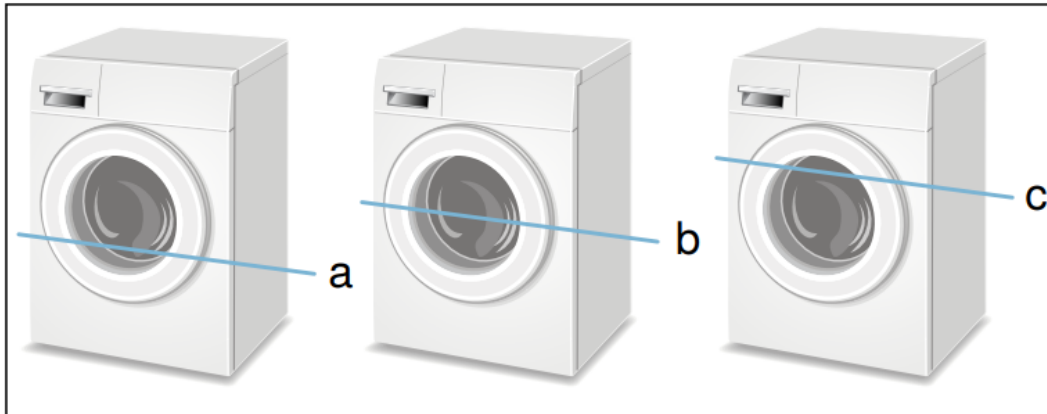

a. 1/3 Load - woolens, delicates, silk

b. 1/2 Load - cotton, synthetic fabrics, or knitted textiles

c. Full Load - cotton and linen

Tips

After loading, close the door carefully so as not to trap any items between the door and the rubber seal. The door should close easily and should not be forced to close.

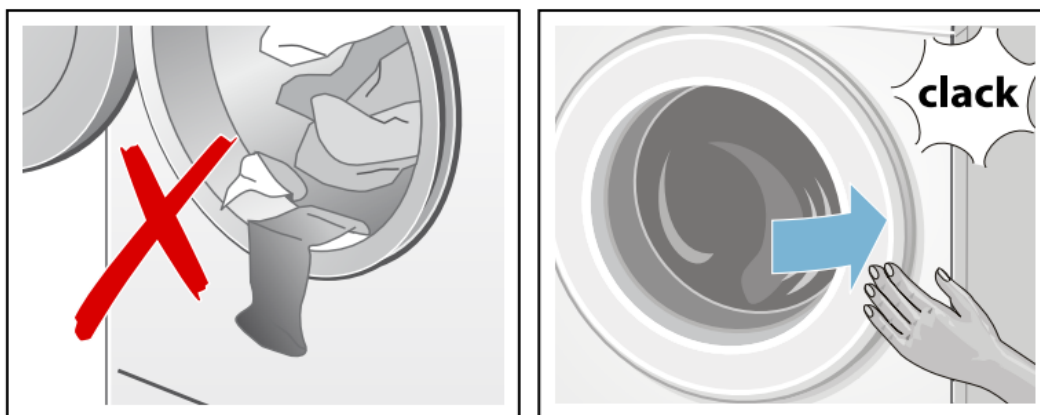

Foreign objects left in the drum may damage laundry. Before inserting any laundry, check to make sure no foreign objects are in the drum.

Filling the detergent and additives compartments

NOTICE: Damage to the appliance Detergent and laundry pre-treatment aids (e.g. spot remover, pre-wash sprays, etc.) can cause damage if they come into contact with the surfaces of the washer. Do not let these substances touch the surfaces of the washer. If necessary, wipe off spray traces and other traces/drops immediately with a soft cloth.

Measuring



Measure out the detergent and laundry care products according to:

- the water hardness; consult your water utility company for details
- the manufacturer's instructions on the packaging
- quantity of laundry
- amount of soiling (heavy, normal, light)

Filling

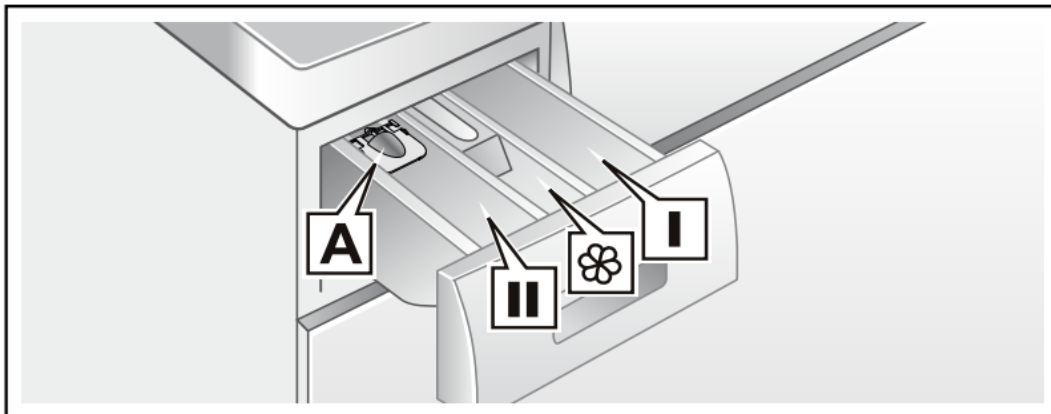
Pour the detergent and laundry care product into the appropriate chambers:



Liquid detergent insert A	for liquid detergent
for liquid detergent 	
Softener chamber 	<p>Fabric softener, starch</p> <p>Do not exceed max</p> <p>Tips</p> <p>Do not pour fabric softener directly into the wash load. Fabric softener is automatically dispensed during the last rinse cycle. Dilute concentrated or thick fabric softener or fabric conditioner with water. Use 2/3 water to the amount of softener to prevent blockage of the siphon.</p>
Main-wash chamber II	<p>Detergent for main wash, water softener, spot remover</p> <p>NOTICE: . Do not use Chlorine based or color safe bleaches as these could damage the washer. Detergents and/ or solid bleaching agents based on Oxygen (like Sodium Percarbonate) are safe to use.</p>

1. Open the detergent dispenser tray.
 2. Add detergent or additive. Avoid overfilling the compartment to prevent early dispensing.
 3. Close the detergent dispenser tray completely before starting the wash cycle.
- Tip: DO NOT operate the washer without the detergent compartment in place and fully closed.

Liquid detergent insert

To measure liquid detergent:

1. Pull out the detergent dispenser tray.
2. Push the liquid detergent insert forward and down as shown.
3. Pour liquid detergent into the chamber and do not exceed the maximum mark.
4. Reinsert the tray into its compartment.

Starting the program

Press the Start/Pause button. Indicator lamp lights up and the program starts.

NOTICE: If you want to protect the cycle against inadvertent adjustment, select the Child lock.

→ Child lock; Page 37

The display panel shows the "Finish in" time before the program starts or the program length and the program progress symbols when the washing program has started.

→ Display area; Page 22

Foam detection

If you use too much detergent, too much foam may be formed during the wash cycle. The symbol Å lights up. Foam may be also leaking out from the detergent drawer. In order to remove the foam, the appliance automatically activates additional rinse cycles. This extends program duration.

NOTICE: To prevent excess foaming use less detergent in subsequent wash loads.

Selecting a different program

If you have inadvertently started the wrong program, you can change this as follows:

1. Press Start/Pause.
2. Select another program.
3. Press Start/Pause. The new cycle starts from the beginning

Pausing/Adding a garment to the cycle

Pausing the wash cycle can be useful for several purposes. e.g. for soaking → Soaking; Page 35

Press Start/Pause. The indicator lamp  is blinking. Wash load will soak in water until continued by pressing Start/Pause. For adding a garment after the cycle begins.

1. Press Start/Pause. Door will unlock when safe to do so.
2. Open door carefully and add or remove laundry item. NOTICE: You can do this as long as the Start/Pause indicator flashes and it is safe to do so.
3. Close door.
4. Press Start/Pause. The cycle continues.

NOTICE: If the cycle is paused but the door will not unlock it could be for safety reasons (high water level, water temperature or drum speed).

Cancel program

For cycles with a high temperature:

1. Press Start/Pause.
2. Cool the laundry off: Select Rinse.
3. Press Start/Pause.

For cycles with a low temperature:

1. Press Start/Pause.
2. Select Spin/Drain and Spin Speed option to No Spin.
3. Press Start/Pause.

Program end

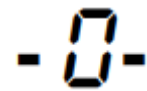

appears in the display field and the Start/Pause button indicator lamp is off.



NOTICE: If this symbol appears in the display, the washer has detected too much foam and it automatically adds an additional rinse cycle to remove the foam. Use less detergent the next time you run the washer with the similar load.

Removing laundry/switching the appliance off

1. Open the front door of the washer and remove the laundry.
2. Press the center of Program Selector to switch off the appliance.
3. Turn off the water taps.

NOTICES

- Do not leave any laundry in the drum. It can shrink or become discolored by the next laundry load.

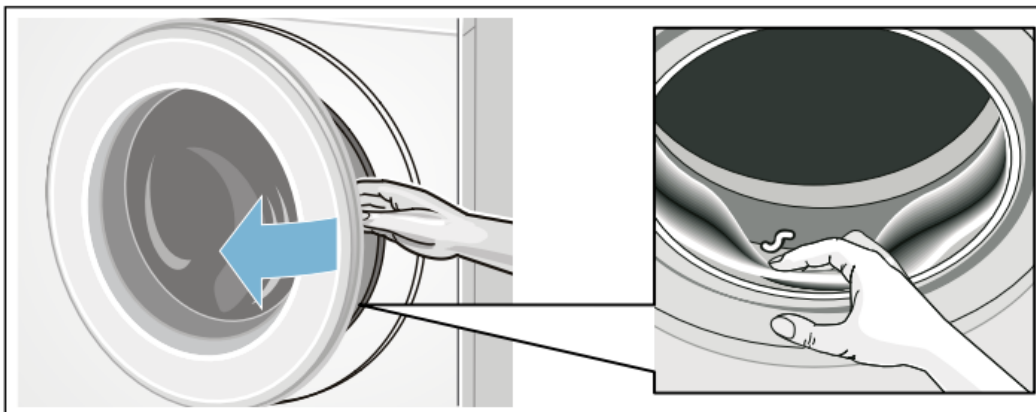

- Remove any remaining items from the drum and rubber gasket.

- Leave the front door and detergent drawer open so that any remaining water can dry.
- Always wait for the end of the cycle before switching off the appliance; otherwise, the appliance may still be locked. If locked, switch the appliance on and wait until it unlocks.
- If the display panel switches off and the Start/Pause button indicator is blinking at the end of a program, the Energy-saving mode is active. To activate the display, press any button.

Home Connect

Home Connect This appliance is Wi-Fi enabled and can be controlled remotely via a smartphone or tablet PC. With the Home Connect app, you can use your smartphone or tablet PC to do the following on this appliance:

- Select and start programs.
- Change program settings.
- Query program status.
- Change appliance settings.
- Switch off appliance.

Before you can use the Home Connect functions, you will need to install the Home Connect app on your smartphone or tablet PC, register, connect your appliance once automatically or manually to your home network, and then connect your mobile device to your appliance via the Home Connect app.

You can find information about the app on our Home Connect website

The availability of the Home Connect function depends on the availability of Home Connect services in your country. Home Connect services are not available in every country. You can find more information at the website

Connecting to your home network automatically



If your router has a WPS function, you can connect the appliance to your home network automatically. If your router does not have a WPS function, you will need to connect the appliance to your home network manually.

1. Switch the appliance on.

2. Press and hold Remote Start for at least 3 seconds.
(connect automatically) will appear on the display

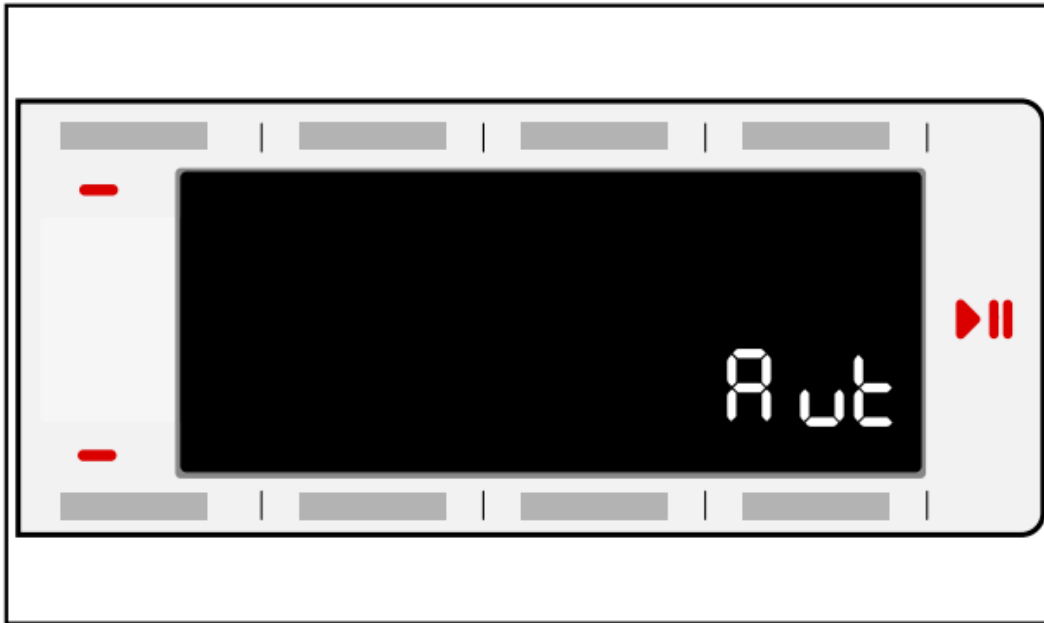



3. Press Start/Pause to connect to the network.  will flash on the display. The appliance will now try to connect to your home network.
4. Activate the WPS function on your home network router within the next 2 minutes. If the appliance has connected to your home network successfully, **CON** (connected) will appear on the display and  will be lit continuously.
5. Press Remote Start briefly to exit the Home Connect settings.

Connecting to your home network manually

If your appliance has already been automatically connected to your home network, you can skip the manual connection step. If your router does not have a WPS function, you will need to connect the appliance to your home network manually.

1. Switch the appliance on.
2. Press and hold Remote Start for at least 3 seconds. **Aut** (connect automatically) will appear on the display.



3. Turn the program selector to position 2. *SAP* (connect manually) will appear on the display.

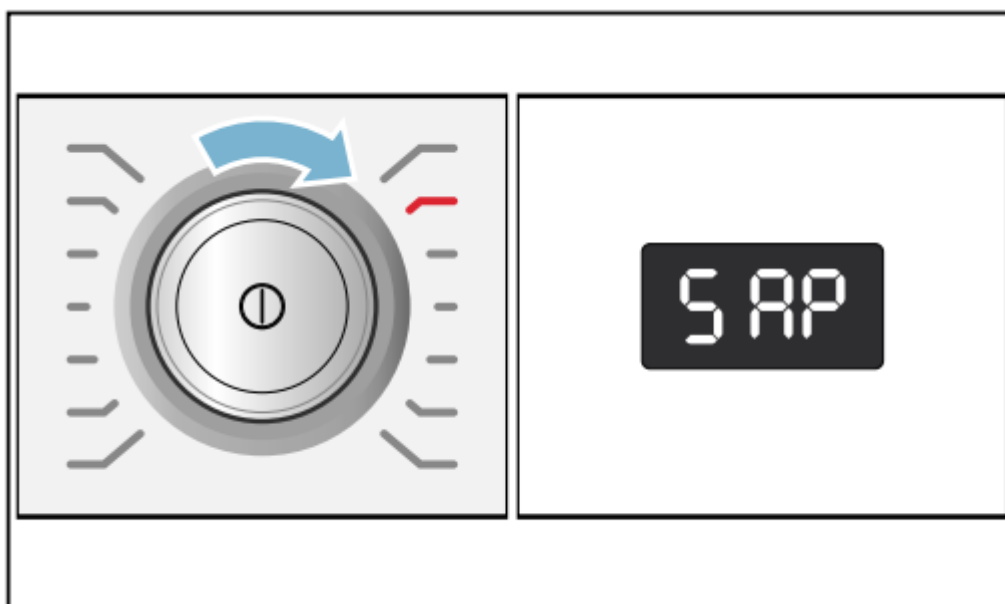

4. Press Start/Pause to connect to the network. | will flash on the display.

The appliance will now set up its own WiFi network with the name (SSID) Home Connect. You can access it on your smartphone or tablet PC.

5. Call up the Wi-Fi setting on the mobile device.

6. Connect your smartphone or tablet PC to the Home Connect WiFi network and enter the password (key) "HomeConnect".

Note: The connection process may take up to 60 seconds.

7. Once you have connected successfully, open the Home Connect app on the mobile device.

8. In the Home Connect app, enter the name (SSID) and password (key) for your home network and then select Transfer to appliance.

If the appliance has connected to your home network successfully, **CON**

(connected) will appear on the display and  will be lit continuously.

9. Press Remote Start briefly to exit the Home Connect settings.

Connecting to the Home Connect app

If your appliance is connected to your home network, you can connect it to the Home Connect app.

1. Switch the appliance on.

2. Press and hold Remote Start for at least 3 seconds. **Aut** (connect automatically) will appear on the display



3. Turn the program selector to position 3. **APP** (connect to app) will appear on the display

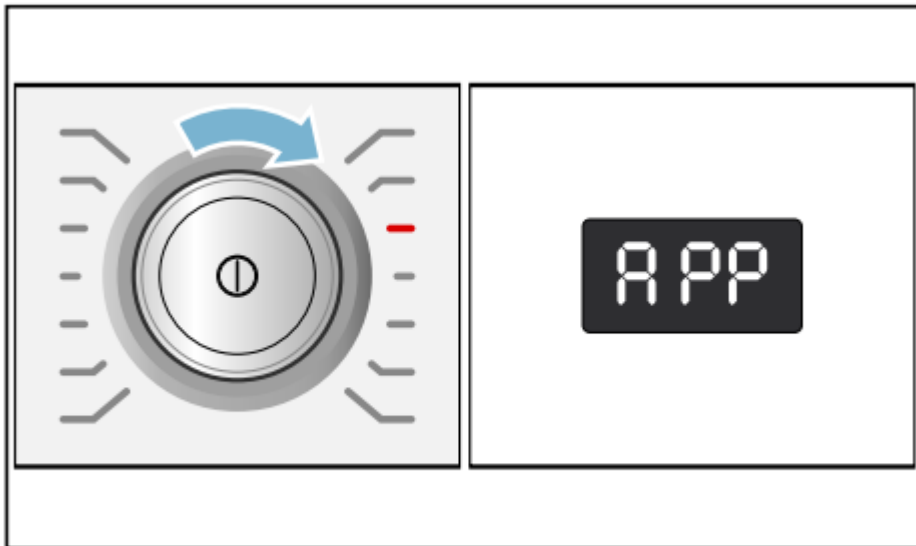

4. Press Start/Pause .

The appliance will now connect to your Home Connect app.

5. Open the Home Connect app on your smartphone or tablet PC and select Connect to add your new appliance.

Note: If your smartphone or tablet PC is still connected to the Home Connect network, you will need to connect it to your home network first.

6. If your appliance is not shown automatically, select Appliance search and then Connect an appliance in the Home Connect app.

7. Carry out the last steps in the Home Connect app to connect your appliance.

If the appliance has connected to your home network successfully, **CON** (connected) will appear on the display.

8. Press Remote Start briefly to exit the Home Connect settings

Activating/deactivating Wi-Fi

You can switch the Home Connect function on your appliance on or off permanently at any time.

1. Switch the appliance on.

2. Press and hold Remote Start for at least 3 seconds. **Aut** (connect automatically) will appear on the display



3. Turn the program selector to position 4. *Con* (WiFi function) will appear on the display.

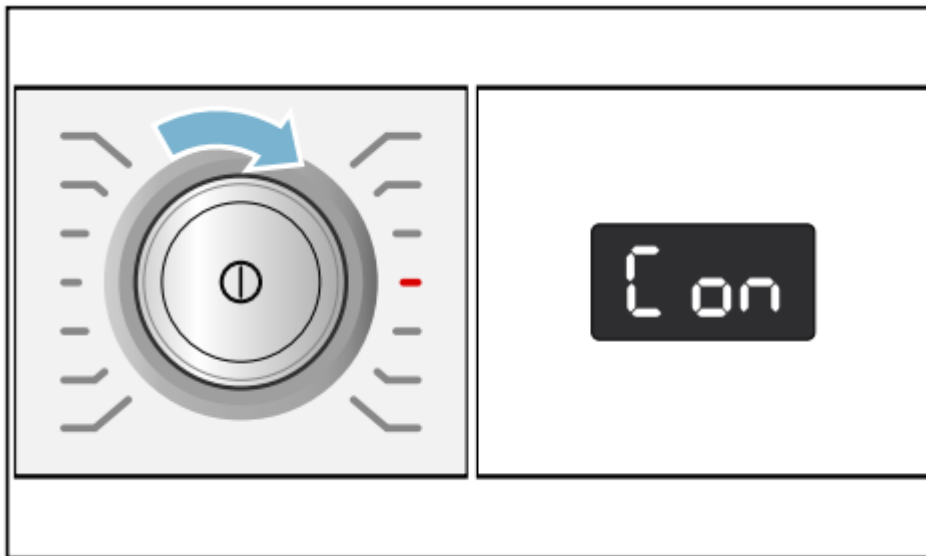

4. Press Start/Pause .

If *on* (switched on) appears on the display, the WiFi function on the appliance has been activated. If *off* (switched off) appears on the display, the WiFi function is not active.

5. Press Remote Start briefly to exit the Home Connect settings.

Resetting your network settings

You can clear the network settings and break the connection to your smartphone or tablet PC by resetting the network settings.

1. Switch the appliance on.

2. Press and hold Remote Start for at least 3 seconds. **Aut** (connect automatically) will appear on the display



3. Turn the program selector to position 5. **rES** (reset network settings) will appear on the display

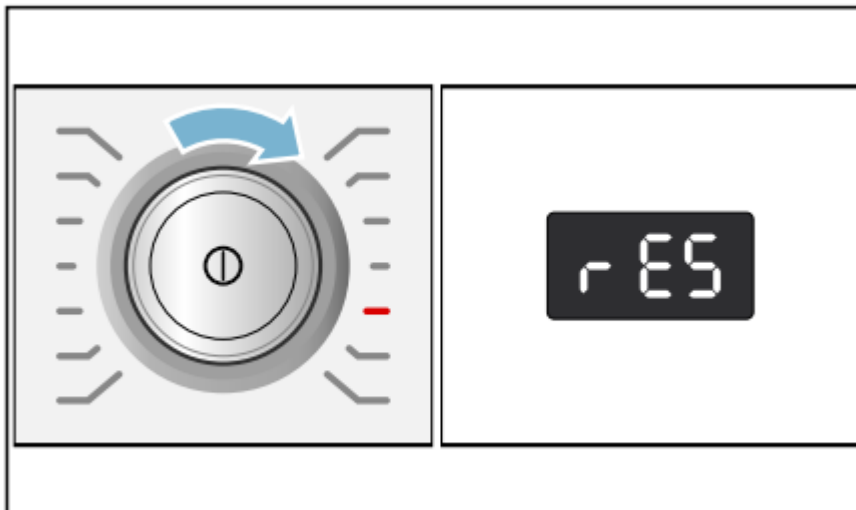

4. Press Start/Pause .

YES (yes) will appear on the display.

5. Press Start/Pause to confirm.

End (end) will appear on the display. The network settings have now been reset. Your appliance is no longer connected to your home network or the Home Connect app. 6. Press Remote Start briefly to exit the Home Connect settings.

Updating the software

You can update the Home Connect software on your appliance. As soon as a new update is available, *UPd* (update) will appear on the display.

You can install the update directly via the message on the display or, alternatively, you can do this manually.

1. Switch the appliance on.

2. Press and hold Remote Start for at least 3 seconds.

Aut (connect automatically) will appear on the display



3. Turn the program selector to position 6. *UPd* (update) will appear on the display.

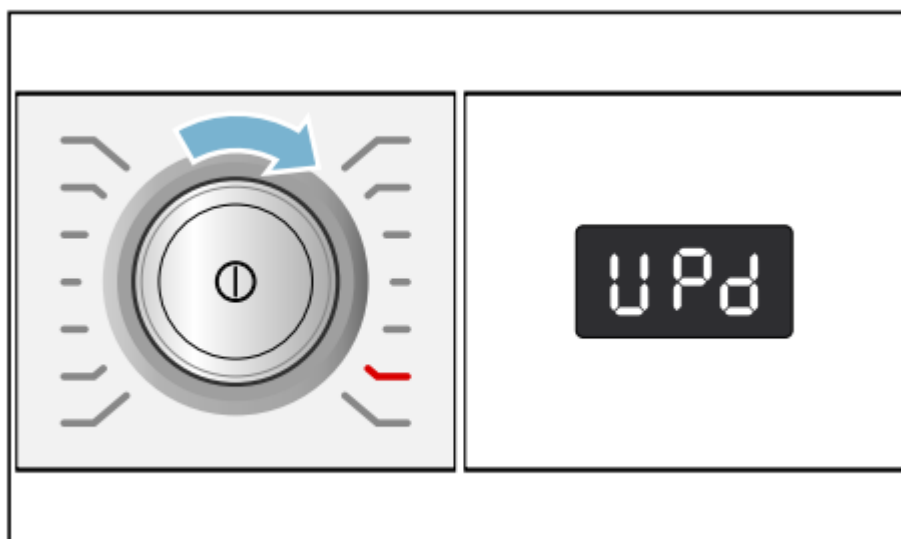

Start/Pause will flash if a software update is available.

4. Press Start/Pause .

YES
(yes) will appear on the display.

5. Press Start/Pause to confirm. Update installation will now start. This process may take several minutes. Do not switch the appliance off while updates are being installed.

6. Press Remote Start briefly to exit the Home Connect settings.

Laundry

Preparing the laundry

NOTICE: Damage to the appliance/fabrics Foreign objects (e.g. coins, paper-clips, needles, nails) may damage the laundry or components in the washing machine.

Therefore, note the following tips when preparing your laundry:

- Empty all pockets to ensure no loose debris (coins, keys, other hard objects) are placed in the washer drum.
- Close any fasteners (such as zippers and hooks) that could cause laundry to catch or become entangled.
- Remove any foreign objects or non-washable parts.
- Turn trousers and knitted wear inside out prior to washing.
- Place small items (such as socks and handkerchiefs) and underwired bras into a mesh bag prior to washing.
- When washing laundry to be tumble-dried, use the correct amount of detergent and textile care products as specified in the manufacturer's instructions. Some detergents

and textile care products, starch or softeners may contain chemicals that may become deposited on the moisture sensors negatively affecting their function and the drying result.

Sorting the laundry

Sort laundry items according to color, degree of soiling and recommended wash temperature range.

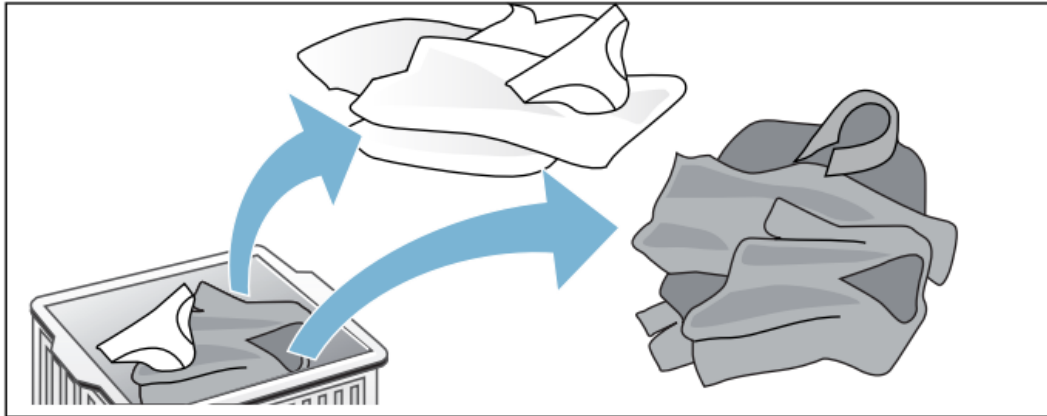

Wash white items separately from colored items. Otherwise, white items may tend to become grey

Observe laundry care labels

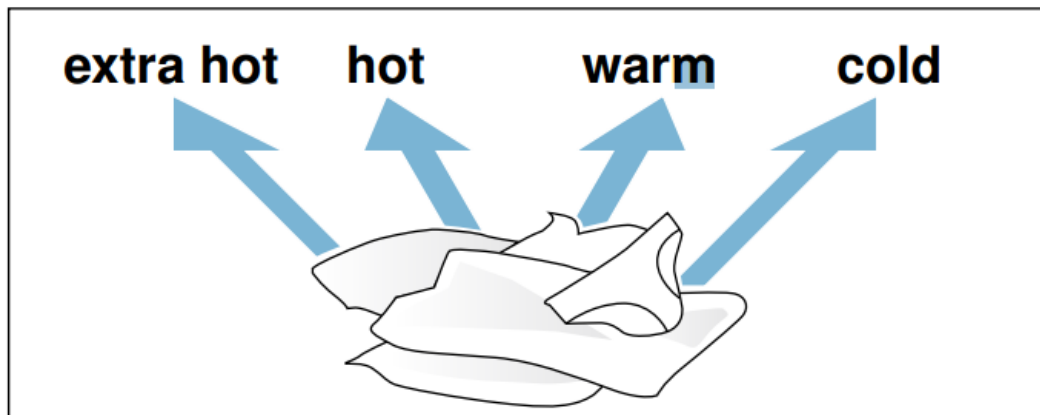

Check the care labels on each laundry item prior to washing. They provide valuable information as well as limitations about the laundry process (temperature etc.) to help you choose an appropriate cycle.

Determining degree of soiling

- Light soiling

No visible soiling or stains, but may have absorbed some odor. This could include light weight summer clothing such as T-shirts, shirts, or blouses worn only once. Also to freshen bed linen or guest towels.

• **Normal soiling**

Visible soiling and/or a few light stains. This could include clothing such as T-shirts, shirts, or blouses that have been sweated in or worn several times. Also tea towels, hand towels or bed linen used for up to one week or more. Curtains without stains that have not been washed for up to a half year.

• **Heavy soiling**

Visible soiling and stains. This could include kitchen towels, fabric napkins, baby bibs, children’s outer clothing or football jerseys and shorts stained with grass or dirt. It could also include working clothes such as overalls and jeans and other clothing worn for outside work and activities.

Identifying and treating stains

For mild and recent stains the Stains button for food based grease/oils, blood, red wine and grass can be used. For more stubborn and set in stains the below methods can be of help.

	Oils and grease: normal body skin oil, cooking oils/fats, sauces, mineral oil, or wax (containing fat/oil). Treatment: scrape residue from fabric. Pretreat. Wash using hottest water safe for the fabric. For heavy stains, apply non-flammable dry cleaning fluid to back of stain, replacing towels under stain frequently. Rinse thoroughly and wash using hottest water safe for the fabric.
	Beverages and juices: tea, coffee, red wine, fruit, vegetables. Treatment: Pretreat stain. Wash using cold water.
	Proteins and carbohydrates: blood, egg, milk, starch. Treatment: Rinse immediately in cold water. If stain remains, soak in cold water with an enzyme prewash.
	Soot, dirt, sand (pigments), red clay (such as soiling of tennis clothing). Brush off residue if present. Pretreat or soak with a laundry product containing enzymes.

Removing stains

- Remove/pretreat stains as soon as possible after they have occurred.
- Dab with a soapy solution. Do not rub.



- Select an appropriate wash cycle and wash the item. Several washing cycles may be required in order to remove stubborn or dried-in stains.

Laundry detergents and additives

Adding the correct amount of HE detergent

Avoid overuse of detergent. Measure out the detergent according to:

- The amount of laundry.
- The degree of soiling. → Sorting the laundry; Page 32
- The water hardness. This information can be obtained from your local water authority. Soft water requires less detergent.

Too much detergent

- Excessive foam will reduce washing agitation and cause poor washing and rinsing results.
- Not environmentally compatible (wastes detergent and is not good for the environment).

Too little detergent

- Laundry will not be washed clean.
- Eventually the laundry will take on a grey and hard appearance. Greyish-brown grease spots may stain the laundry, heating elements may begin to calcify.

The fabric care label is important for selecting the correct detergent, temperature and treatment of the laundry. If desired you can visit the following sites for additional information on detergents and fabric care.

- **Standard detergent with optical brighteners**

Suitable for white laundry made from linen or cotton Program: Cotton / Cold - Extra Hot

- **Detergent for colors without bleach or optical brighteners**

Suitable for colored laundry made from linen or cotton Program: Cotton / Cold - Hot

- **Detergent for colors/delicates without optical brighteners**

Suitable for colored laundry made from easy-care and synthetic fabrics. Program: Permanent Press / Cold - Hot

- **Detergent for delicates**

Suitable for delicate, fine fabrics, silk or viscose Program: Delicates / Cold - Hot

- **Detergent for woolens**

Suitable for wool

Hand Wash/Wool program: Cold - Warm

Saving energy and reducing detergent

For light and normal soiling, you can save energy (lower washing temperature) and detergent.

Saving	Soiling/note
Reduced temperature and detergent quantity as per the recommended dosage	Light e.g.: <ul style="list-style-type: none">• Light summer/sports clothing (worn for a few hours)• T-shirts, shirts, blouses (worn for up to one day)• Guest bed linen and hand towels (used for one day) No visible dirt or stains. Clothing has taken on some body odor.
Temperature as per the care label and detergent quantity as per the recommended dosage for heavy soiling	Normal e.g.: <ul style="list-style-type: none">• T-shirts, shirts, blouses (sweat soaked, worn a few times)• Towels, bedding (used for up to one week) Visible dirt or a few light stains. Heavy Dirt and/or stains clearly visible, e.g. tea towels, baby items, work clothing

Program selection table

Programs	Max. Load up to:	Selectable program settings, default settings (bold)		Type of laundry	Optional program settings; Information
		Temperature	Spin speed		
Cotton	full load	Extra Hot Hot Warm Cold	High 	Sturdy fabric, cotton or linen fabric that withstands very hot water	SpeedPerfect, EcoPerfect, Rinse Plus, Prewash, Stains
Towels	1/2 load	Extra Hot Hot Warm Cold	High Medium Low	Durable, cotton towels; especially terrycloth type towels	SpeedPerfect, EcoPerfect, Rinse Plus, Prewash, Stains
Whitest Whites	full load	Extra Hot Hot Warm Cold	High Medium Low	White sturdy fabric, cotton or linen fabric that withstands very hot water	Rinse Plus, Prewash, Stains
Sanitize	1/2 load	Extra Hot	High Medium Low	Sturdy fabric, cotton or linen fabric that withstands very hot water	SpeedPerfect, EcoPerfect, Rinse Plus, Prewash, Stains longer wash and rinse with more water for especially sensitive skin
Hand Wash/Wool	1/3 load	Hot Warm Cold	Medium Low No Spin	Hand and machine washable wool/wool blend fabrics	Especially gentle washing cycle to avoid shrinkage, long cycle pauses (clothing rests in suds and water)
Bulky/Large Items	full load (1 item)	Extra Hot Hot Warm Cold	High Medium Low	NOTICE: Wash large items separately. Use a detergent designed for delicates and follow the instructions on the item's care label. Use detergent sparingly.	SpeedPerfect, EcoPerfect, Rinse Plus
Drum Clean	empty		High	Special cycle for cleaning the drum	
Spin/Drain	full load		High Medium Low No Spin	Extra spin with selectable speed	
				Draining of the rinsing water	Draining of the rinsing water without extra spin at "No Spin"
Rinse	full load		High Medium Low No Spin	Extra rinse with spin	Rinse Plus
Quick 30 (approximately 30 minute cycle)	1/2 load	Hot Warm Cold	High Medium Low	Easy-care fabrics made of cotton, linen, synthetic fibers or blended fabrics; suitable for lightly soiled laundry	
SuperQuick 15 (approximately 15 minute cycle)	1/4 load	Hot Warm Cold	High Medium Low	Extra-short program of approximately 15 minutes, suitable for small item of lightly soiled laundry	
Delicates	1/4 load	Hot Warm Cold	Medium Low No Spin	For delicate, washable fabrics, e.g. made of cotton, satin, synthetic fibres or blended fabrics (e.g. curtains) bulky items (e.g. comforters)	SpeedPerfect, EcoPerfect, Rinse Plus, Prewash, Stains
Perm P Heavy Soil Permanent Press	1/2 load	Hot Warm Cold	High Medium Low	Cotton, linen synthetic or blended fabrics	SpeedPerfect, EcoPerfect, Rinse Plus, Prewash, Stains

Tips

Do not wash new multicolored laundry together with other laundry. The cycles are time-controlled for lightly soiled fabrics. If fabrics are heavily soiled, reduce the load. Rinse cycles use cold water only

Starching

NOTICE: Laundry must not be treated with fabric softener. Starching is possible in all wash programs if liquid starch is used. Measure starch into compartment M in accordance with the manufacturer's instructions (clean first if necessary).

Dyeing/bleaching

Dye should only be used in normal household quantities. Salt may damage stainless steel. Always follow the dye manufacturer's instructions. Do not use the washing machine to bleach clothes.

Soaking

1. Pour soaking agent/detergent into compartment II in accordance with the manufacturer's instructions.
2. Turn the program selector to Cotton program and select Cold temperature.
3. Press Start/Pause.
4. After approximately ten minutes, press Start/Pause.
5. After the required soaking time, press Start/Pause again to continue or change the program.

Optional program settings

At the factory, temperature and spin speed options, and cycle duration ("Finish in" time) are pre-set for all cycles. After selection of the cycle, these values are displayed in the display field.

EcoPerfect

Energy optimised washing by reducing the temperature while achieving a washing result that is consistent with the selected program, without the EcoPerfect setting.

Prewash

For heavily soiled washing. Pour 1/3 of normal detergent amount into pre-wash chamber I and remaining 2/3 into main wash chamber II.

Rinse Plus

This feature adds additional rinses to selected program which is helpful for locations with soft water supplies or to generally improve rinsing results. It will increase the program duration.

Remote Start

Briefly pressing the Remote Start button activates or deactivates the Remote start function. Activating the Remote start function enables the appliance to be started remotely via the Home Connect app.

Finish in

The program end (Finished in) time can be set in one hour increments to a maximum of 24 h (hours). After selecting the desired washing program (at the dial) but before pressing the Start/Pause button, press the Finish in button until the desired time is displayed, e.g. 8 h. Press the Start/Pause button to start the washer.

Spin Speed

Before and during the cycle, you can change the spin speed range depending on the cycle progress.

Touch the appropriate button until the desired setting is displayed.

No Spin: This option eliminates the final spin and the load remains saturated with the final rinse water. The pump is activated to remove all residual water.

→ Program selection table; Page 34

Temperature

Before and during the cycle, you can change the default temperature range depending on the cycle progress. Press the appropriate button until the desired setting is displayed. The maximum temperature range that can be set depends on the cycle selected.

→ Program selection table; Page 34

SpeedPerfect





For washing in a shorter time with a washing result comparable to that of the standard program.

NOTICE: Do not exceed the maximum load.

→ Program selection table; Page 34

Stains

There are four types of stain to choose from:

	Oils, food based
	Blood
	Red wine
	Grass



The washer adjusts the average washing temperature, drum movement and soaking time to the specific type of stain. Hot or cold water, gentle or intensive washing and long or short soaking ensure that the wash-program sequence is specially adapted to each type of stain. This makes sure that stains are treated in the best possible

Appliance settings

Child lock

You can secure the appliance against inadvertent changing of the set functions.

To do this, activate the Child lock after cycle start. To Activate/Deactivate, press Finish

in  and  for approximately 3 seconds. In the display field, you will see the  symbol light indicating the Child lock is active.

Activating setting mode

In order to change the default appliance settings described below, you will first need to enter or activate setting mode.

To enter or activate the setting mode:

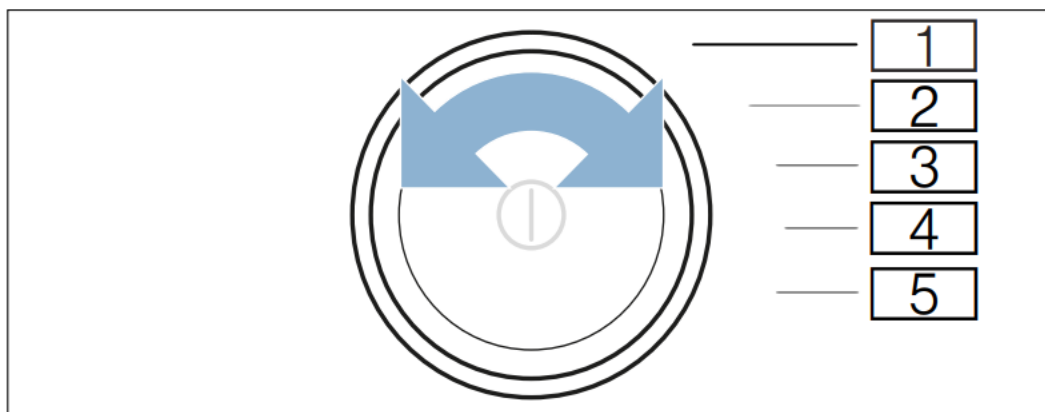

1. Switch on the appliance. The indicator lamp of the program on position 1

(1) lights up.

2. Press and hold Temperature button and, at the same time, turn the program

selector to position 2 (2).

3. Release Temperature button. The setting mode is now activated.

Changing the audible signal volume

You can adjust the volume of audible notification signals (that indicate that a program has ended, for example) and audible button signals by turning the program selector to the following positions:

• 2 (2): Audible notification signal volume selectable values: 0 = off, 1 = quiet, 2 = medium, 3 = loud, 4 = very loud

• 3 (3): Audible button signal volume selectable values: 0 = off, 1 = quiet, 2 = medium, 3 = loud, 4 = very loud

1. Turn the program selector to the required position.

2. Use the Finish in + or - button to set the volume you require (0 = off; 4 = very loud).

Switching the automatic switch-off function on/off

If the appliance is not used for an extended period, it may automatically switch itself off until a program starts or when a program has ended in order to save energy. It can be

switched back on again at any time by pressing the power button ⓘ

You can switch the appliance's automatic switch-off function on or off as follows:

1. Turn the program selector to position 4 (4).

2. Use the Finish in + or - button to switch the appliance's automatic switch-off function on (On) or off (OFF).



NOTICE: The automatic switch-off function cannot be activated if Wi-Fi is activated.

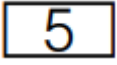

Switching the Drum Clean reminder on/off

A reminder to clean the drum is indicated by a light adjacent to the Drum Clean program. In order to switch the drum clean reminder on (or off, if desired):

1. Turn the program selector to position 5 ().

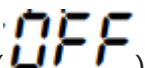
2. Use the Finish in  or  button to switch the drum clean reminder on () or off ().

Exiting setting mode

Once you have applied all the settings, press the power button  to switch off the appliance.

The settings you have selected will be saved and will take effect the next time the appliance is switched on.

Cleaning and maintenance

Cleaning the housing and control panel

As required, you may clean the washer housing and control panel.

- Use hot soapy water or a mild (non-abrasive) cleaning agent.
- Dry with a soft towel.
- Remove residue immediately.
- Do not use high-pressure spray

Cleaning the drum

Metallic debris left in the drum can produce rust spots on the drum. Never use steel wool to try to remove these. Use a chlorine-free cleaning agent and follow the manufacturer's instructions.

Descaling the washer

Provided that you use correct amounts of detergent with your wash loads, descaling is not necessary. If descaling the washer drum does become necessary, please follow the descaling product manufacturer's instructions. Small amounts of descaling agent can be used to remove white spots on the washer drum caused by lime or mineral deposits or small amounts of rust caused by metal objects left in the drum.

NOTICE: Descaling agents contain acids which may attack parts of the washing machine and may discolor the laundry.

Cleaning the detergent dispenser tray

If there is a buildup of residual detergent or additives, or if the softener compartment is not rinsed out well enough, it may be helpful to clean the dispenser.

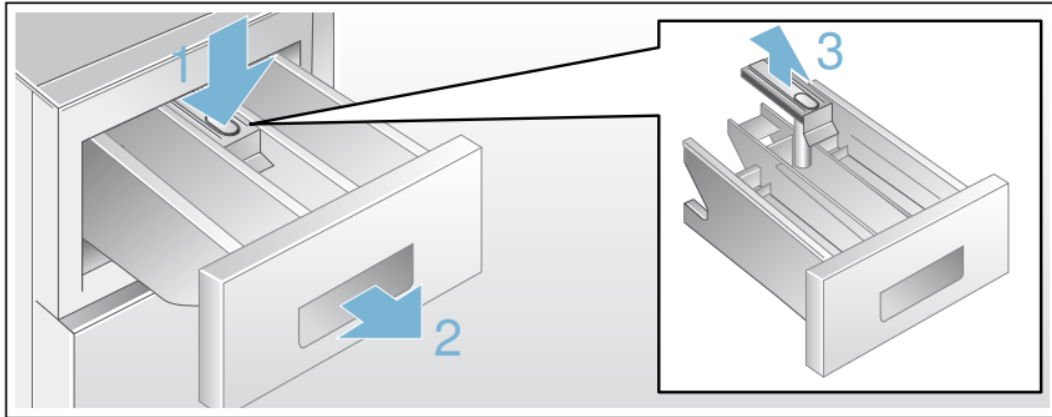

1. Open the detergent dispenser tray fully. Press down on the drawer catch (1) and pull the tray (2) from the washer housing.

2. Remove the insert (3) by grasping it and pulling it upwards from the detergent dispenser tray.

3. Clean the insert and the detergent dispenser tray by holding it under warm running water. Lightly wipe away any remaining detergent residue.

4. Attach the insert and slide the detergent dispenser tray back into place and close the tray securely.

Tip: Do not operate the washer without the detergent dispenser tray in place. Always keep the tray completely closed.

Cleaning the water inlet strainers

If the washer water supply slows or stops completely, the water inlet strainer may be blocked. Cleaning is recommended every 6 months in any event to reduce chances of valve blockage in areas using hard water.

Normal water pressure from your home, that remains in the supply hoses after turning off the taps, will cause a small amount of water to drip out when you remove the water supply hose from the back of the washer. Be sure to close the taps completely before removing the supply hoses to minimize the amount of water. Clean the strainers at the water tap end of the hose

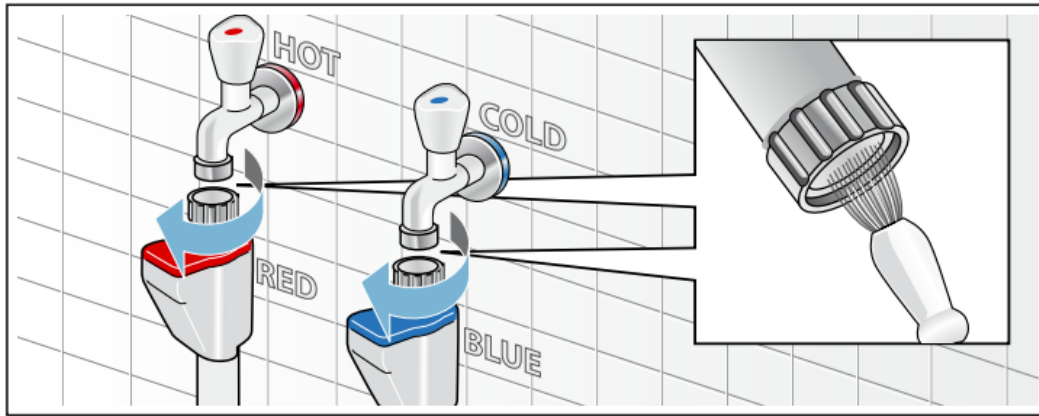

1. Remove the hose from the tap.
2. Rinse the strainer under running water. Look at the strainer to see if any visible debris is still present. Rinse again if necessary to remove the debris.
3. Reconnect the hose to the tap.

Clean the strainers at the washer end of the hose

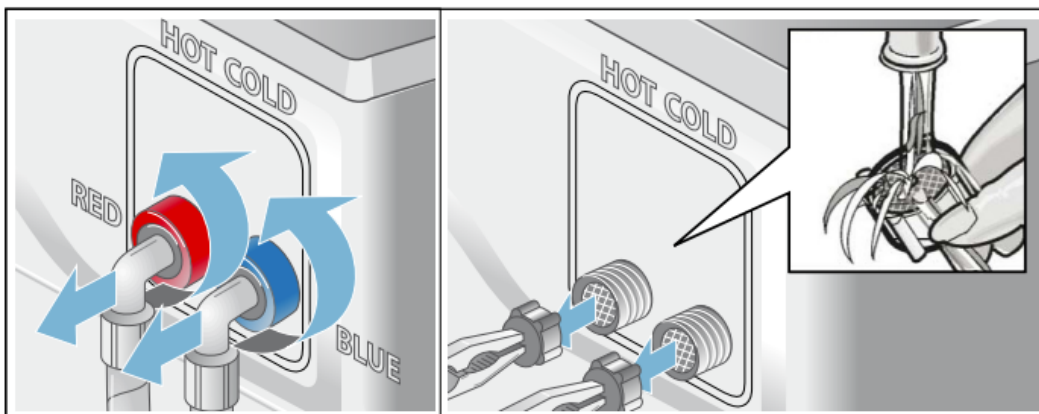

1. Remove the hose from the inlet on the back of the washer.
2. Using narrow pliers, grasp and pull the strainer from the inlet port.
3. Rinse the strainer under running water.
4. Reconnect the hose to the back of the washer and turn on the water tap. Check to see if water flows by starting a warm water wash cycle.

Cleaning the drain pump

It may be necessary to clean the washer drain pump if the washer fails to drain (sound of water being pumped from the washer cannot be heard when the washer should be draining and other nearby drains, such as a sink, are draining properly).

The washer pump can become blocked by loose debris (a good reason to check the drum and remove any visible debris after each load). Fabrics that give off large amounts of fluff may also cause blockage.

To access the washer drain pump, the service cover must first be removed (see steps below). With the service cover removed, proceed as follows:

1. If the washer has not been drained, try to drain it now. Turn the program selector to the Spin/Drain, select Spin Speed to No Spin and press the Start/Pause button. Wait a few moments to let the cycle drain the water from the drum. If the pump is totally blocked, the water will be unable to drain and the cycle will end.
2. Shut off the tap so that no more water flows in and has to be drained. Switch the appliance off. Unplug the power plug.
3. Open and remove the service cover.

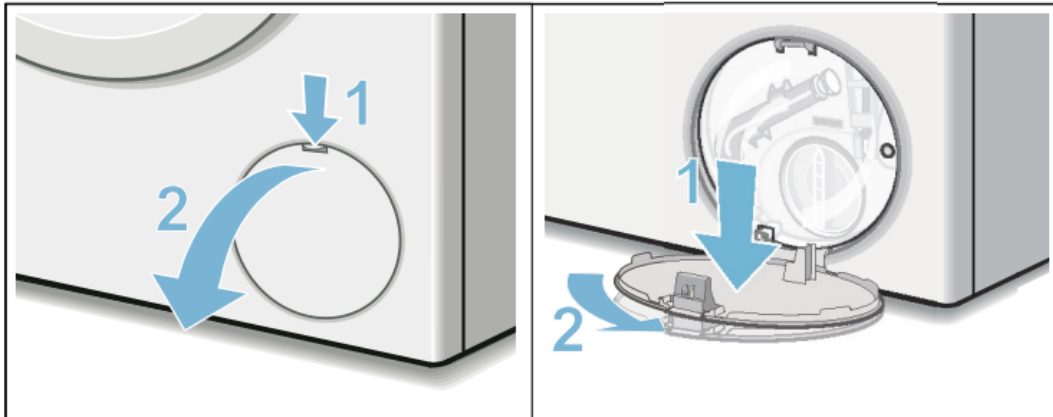

4. Loosen the screws and remove the protective film.

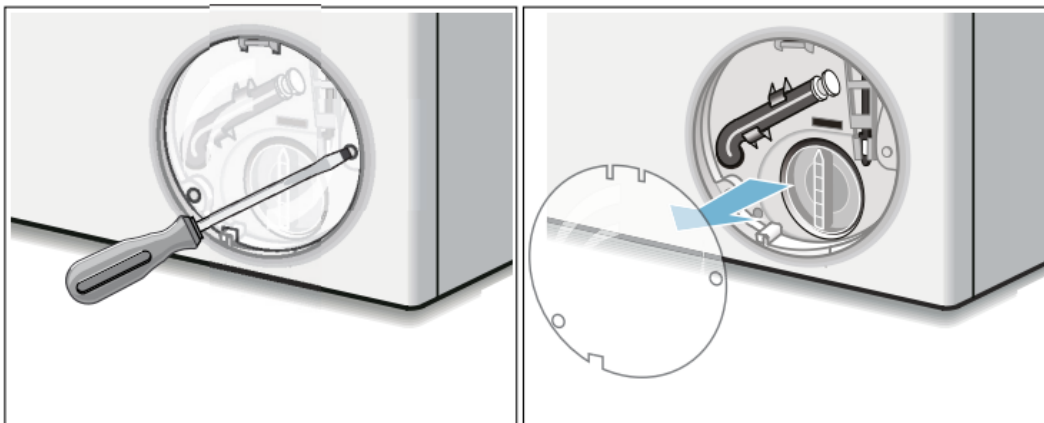

5. Use the pull-out drain hose located in the pump access opening to drain the remaining water into a suitable container (up to 5.3 U.S. gallons/20 liters of water may be drained). Pull the sealing cap from the hose and lay the hose over the side of the container and allow the water to finish draining from the drum.

When finished, replace the sealing cap into the end of the hose and restore the hose to its storage location.

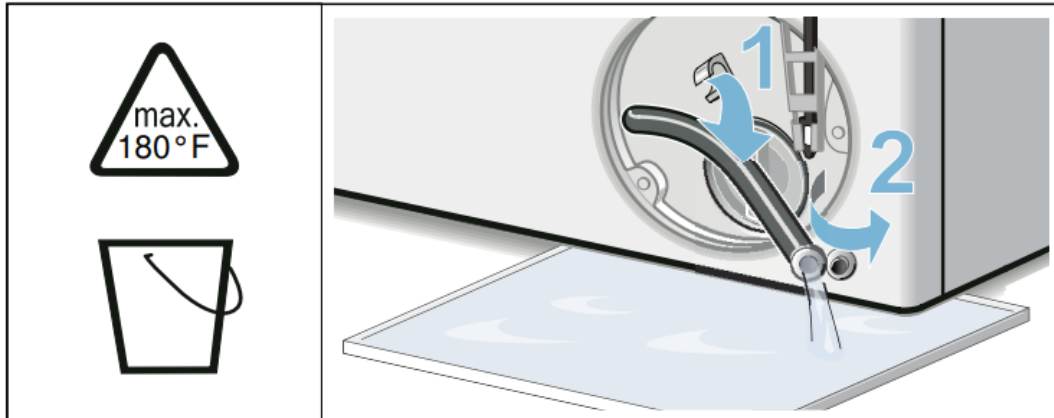

6. Turn the pump cover counterclockwise to remove it. A small amount of residual water may flow out when the cover is removed.

Clean the interior of the pump housing, removing any debris or foreign objects. Check to be sure the impeller wheel at the back of the pump housing can now turn freely.

Remove any lint, debris or detergent residue from the threads of the pump cover and the pump cover housing.

Replace the pump cover by screwing tightly into position. Handle must be vertical.

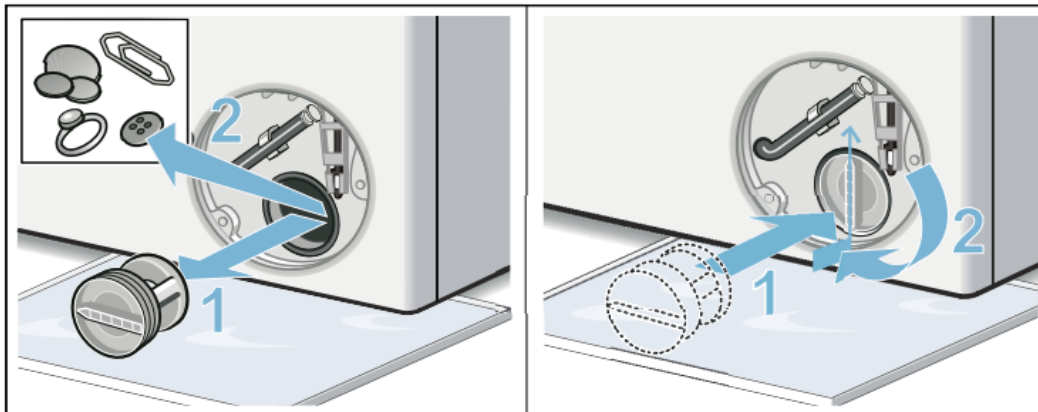

7. Reinstall the protective film over the pump access using both screws

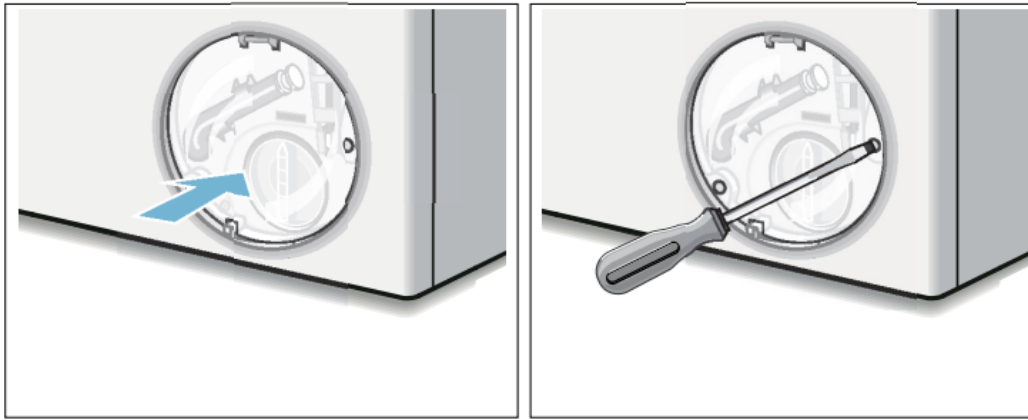

8. Snap the service cover in place at the hinges and close it. Wipe up any spilled water.

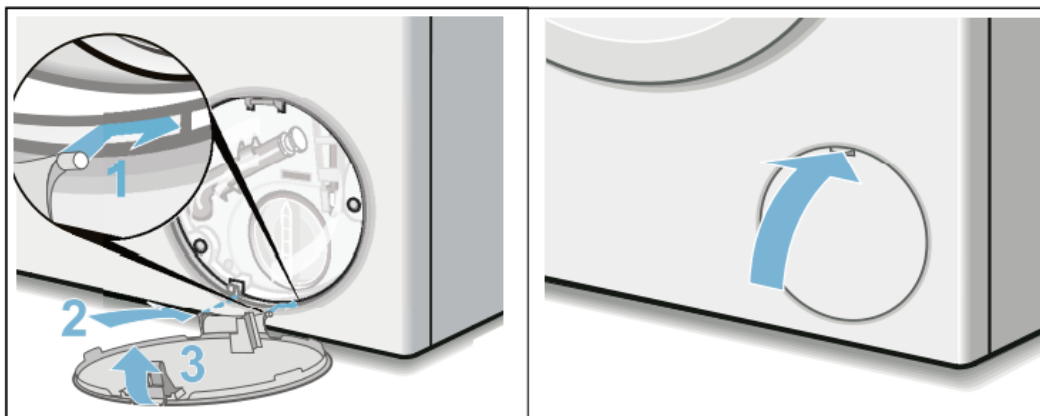

Troubleshooting

Emergency door lock release

In the event of a power interruption, the program will continue running when the power supply has been restored.

If the washer door must be opened and the normal door unlocks procedures do not work, the emergency door lock release rod can be actuated to open the door.

1. Press the center of Program Selector to switch off the appliance. Any running program will then be canceled. Disconnect the power plug.
2. Allow the water in the drum to cool off.
3. Allow the washer drum to come to a standstill (no longer spinning).
4. Before opening the washer door, perform the drain procedure included in the pump maintenance section.
 - Cleaning the drain pump; Page 40
5. Loosen screws and remove the protective foil.

6. The washing machine door can then be opened. Pull the emergency release downwards with a tool and release.

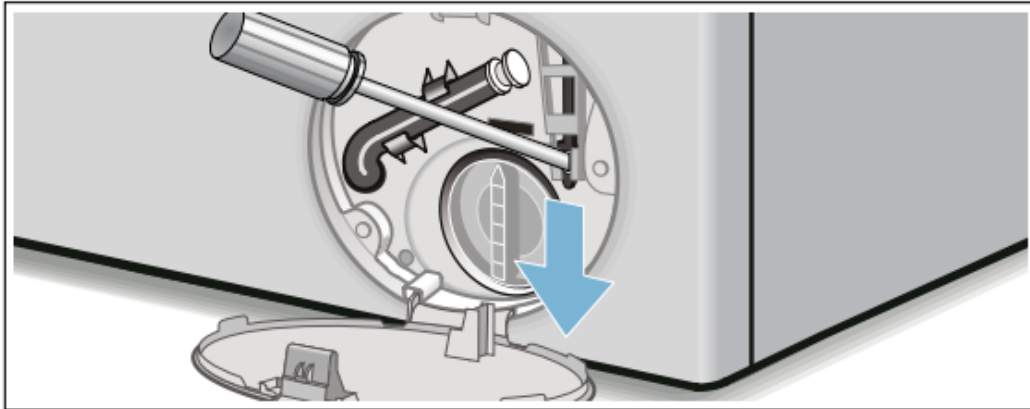

7. The door can now be opened.

General Troubleshooting

If you encounter a problem, consider the suggestions and instructions below before you call customer service.

If repairs are necessary and you cannot eliminate the fault with the aid of the table below, follow these steps:



1. Press the center of Program Selector to switch off the appliance.
2. Disconnect the appliance from the power outlet.
3. Turn off the water taps.
4. Call Customer Service. → Customer Service; Page 5

Determining the Problem

Problem	Possible cause(s)	Solution(s)
Washer door cannot be opened.	Child lock is activated.	Deactivate Child lock (press Finish in M approximately 3 seconds).
	A power failure occurred.	If a cycle is interrupted by a power failure when the power is restored. If power is restored, follow the cautions and instructions for: → Emergency door lock release; Page
	Cycle is running, or water level is too high and/or too hot or the drum is still spinning.	Wait until the cycle ends.
	Electric power cord has become loose or unplugged.	Make sure the electric cord is securely
	Appliance switched off before end of cycle.	Switch the appliance on.
Door still cannot be opened, even after turning the washer off and back on again.	Child lock is activated	Deactivate Child lock (press Finish in M approximately 3 seconds).
	Door is locked for safety reasons (high water level, water temperature too high, drum is spinning)	Run a Spin/Drain program to reduce the temperature and level.
Wash cycle time is increased.	<p>Your washer utilizes sensors to monitor certain characteristics of the wash load. Increases in wash cycle time could be due to:</p> <p>The automatic unbalanced load detection system spins the laundry several times to ensure even distribution.</p>	<p>Solutions are based on the specific reason the cycle time has been extended.</p> <p>Always load the washer with a mixture of large and small wash items (easier to distribute in</p>
	<p>Excess suds.  displays at end of cycle.</p>	Use less detergent.
	Energy-saving mode is activated.	Press any button to activate the display

The display panel and indicator lights switch off, Start/Pause indicator flashes		
The display panel and Start/Pause indicator switch off.	Automatic switch-off function is active.	Press the center of the Program Select the appliance.
Cycle does not start - Start/Pause flashes.	Start/Pause button not pressed?	Press the Start/Pause button to start the
	Washer door is not closed properly	Check if laundry is caught in the door. C until a click is heard. Press the Start/Pa start the cycle.
Cycle does not start - Finish in-time is displayed.	A delayed starting time has been selected and activated.	Wash cycle will begin at proper time to selected Finish in-time.
Cycle does not start -  symbol flashes	Child lock is activated.	Deactivate Child lock (press Finish in — approximately 3 seconds).
Detergent residue remains in the detergent dispenser.	Dry detergent may have been damp or lumpy.	Clean and dry the detergent dispenser.
	Excess liquid detergent may have been added.	See Adding the correct amount of HE d determine proper detergent usage. → A amount of HE detergent; Page 33
Water does not appear to be filling into the washer or detergent is not dispensed from detergent tray	Start/Pause not pressed.	Press Start/Pause.
	Water taps not turned on.	Turn on water taps.
	Supply hose kinked or pinched (reduce flow).	Eliminate the cause.
	Water supply hose strainers clogged.	Clean the water inlet strainers.
	Water pressure too low.	Eliminate the cause.



Water cannot be seen in the drum.	The water level in your high efficiency front load washer is below the visible part of the drum, this is normal.	No action needed.
Water has not drained completely.	Suds may be excessive (usually due to too much detergent or non-HE detergent being used).	Use less detergent for future loads. Be sure to use high efficiency HE-detergents.
	Pump is blocked.	Check and clean the drain pump, water filter, or the drain pipe.
	Drain hose or drain pipe is blocked.	Clean drainage pipe and/or drainage hose.
Water is coming out from underneath the washer.	Water supply hose is leaking: is not screwed on tight at both ends, or rubber washer not placed in hose.	Eliminate the cause: tighten the hose (both washer end), check for rubber washer in place.
	Drain hose is leaking.	Check the drain hose, be sure that it is secured securely with the clamp in place; replace if leaking continues.
Foam comes out of the detergent dispenser drawer.	Too much detergent was used, or a non-HE detergent was used; pump was not able to pump out the increased suds.  displays at end of cycle.	Immediate fix: mix 1 tablespoon of fabric softener with 1/2 liter (1 pint) of water and pour this mixture into the detergent compartment, except if there are heavy type textiles in the load then do not use softener. To prevent: use less detergent for future loads.
Repeated spinning.	The Unbalanced Load Detection system is attempting to balance the load through repeated spin cycles.	To prevent: always load the washer with a mix of large and small wash items (easier to distribute in drum).
No spin took place (laundry is still wet).	Load size too small.	Add more laundry.
	Large items may have become entangled in the drum and could not	

	<p>be distributed by the Unbalanced Load Detection system; spin cycle therefore canceled for safety reasons.</p>	<p>To prevent: always load the washer with large and small wash items (easier to distribute in the drum).</p>
	<p>Excessive suds: too much detergent was used, or a non-HE detergent was used.  displays at end of cycle.</p>	<p>Immediate fix: mix 1 tablespoon of fabric softener with 1/2 liter (1 pint) of water and pour this mixture into the detergent compartment, except if there are delicate type textiles in the load then do not use fabric softener to reduce the foam.</p> <p>To prevent: use less detergent for future loads.</p>
	<p>No Spin was selected</p>	<p>Select a spin speed setting (Low, Medium, High).</p>
<p>Detergent residue on the laundry.</p>	<p>Some phosphate free detergents contain water insoluble ingredients that may appear as light spots on the laundry.</p>	<p>Brush off when laundry is dry or execute an extra Rinse.</p>
<p>System shakes or shudders when spin speed increases.</p>	<p>The washer drum suspension system shifts during spinning as the speed increases. This may result in a slight shaking of the washer during the spin speed transition.</p>	<p>Mix small and large laundry items together to help minimize this effect. Check to be sure the load is level and all four feet press equally against the drum.</p> <p>→ <i>Leveling the washer; Page 18</i></p> <p>Check that transport bolts have been removed.</p> <p>→ <i>Remove the transport bolts; Page 14</i></p>
<p> does not appear in the display panel.</p>	<p>Wi-Fi is switched off.</p>	<p>To connect to your home network, switch Wi-Fi on.</p>
	<p>Wi-Fi is switched on but a connection to the home network cannot be established.</p>	<p>Check whether your home network is active and you are connected to it. If not, connect to your home network again.</p> <p>→ <i>Home Connect; Page 28</i></p>
<p>Home Connect is not working.</p>		<ul style="list-style-type: none"> You can find solutions to problems with Home Connect at www.home-connect.com The use of the Home Connect functions depends on the availability of the Home Connect Services in your country. Check here: Home Connect Services

connect.com, to see if the Home Co
are available in your area and further

Information on the display area

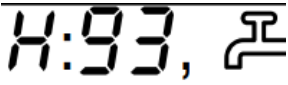

Problem	Possible cause(s)	Solution(s)
 flashes	Door not closed properly or attempting to lock or unlock.	Check that no laundry is caught between door and gasket and close door securely. Wait until door is locked or unlocked.
 flashes	Cold water tap not turned on.	Turn on the cold water tap.
	Supply hose for cold water kinked or pinched closed.	Eliminate the cause, replace the hose if necessary.
	Strainer in water supply hose clogged.	Clean the water inlet strainer. → <i>Cleaning the water inlet strainers; Page 38</i>
	Cold water pressure too low.	Eliminate the cause.
 lights up	Too much detergent used or non-HE detergent used.	Use less detergent for future loads. Only use HE detergents.
The Drum Clean program indicator flashes	Indicates Extra Hot wash temperature has not been used in recent wash cycles.	Run a Drum Clean or other program with extra hot temperature option selected and without laundry.
 is shown	Hot water tap not turned on.	Confirm hot water hose is correctly connected to the hot water tap.
	Supply hose for hot water kinked or pinched closed.	Eliminate the cause, replace the hose if necessary.
	Hot water pressure too low.	Eliminate the cause.
	Strainer in water supply hose clogged.	Clean strainers in supply hoses.

E: 00 <-> - 18	Pump is blocked (obstructed).	Clean the washer drain hose and/or the May need to perform pump maintenance blockage. → <i>Cleaning the drain pump; Page 40</i>
E: 00 <-> - 23	Water in the base, appliance leaking.	Turn off the water tap. Call the customer
Others		Turn off machine, wait 5 seconds, and t the the problem persists, call Customer

Warning

This content is compiled from multiple sources and is provided for reference purposes only. It may not be complete or fully applicable to all situations. If you are unable to resolve your issue, please contact the product manufacturer or an authorized service provider for official support.

