

CONTROL PANEL AND FEATURES

Not all features and cycles are available on all models.

NOTE: The control panel features a sensitive surface that responds to a light touch of your finger. To ensure your selections are registered, touch the control panel with your finger tip, not your fingernail. When selecting a setting or option, simply touch its name

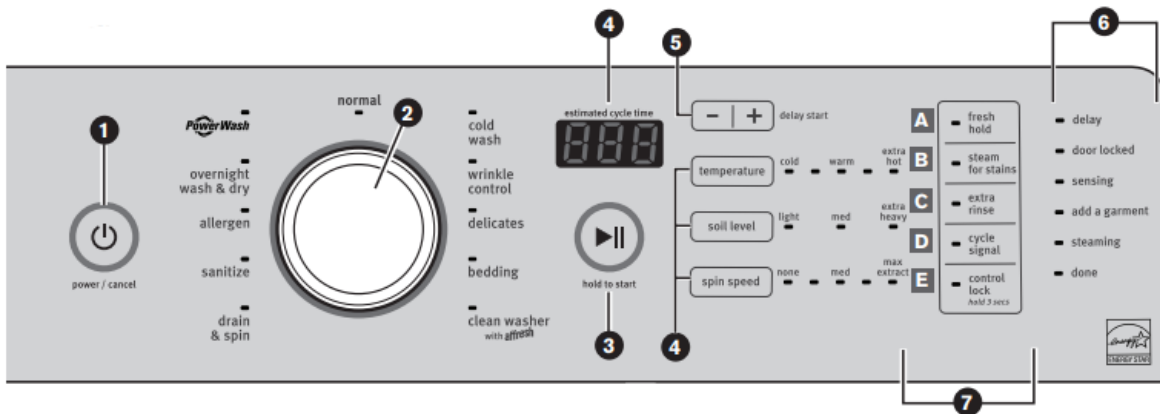

1. POWER/CANCEL

Touch to turn the washer on and off. Touch to stop/cancel a cycle at any time.

NOTE: Turning the Wash Cycle knob will also turn the washer on.

2. WASH CYCLE KNOB

Turn the knob to select a cycle for your laundry load. An LED will light up for the cycle selected.

NOTE: The Clean Washer with affresh® LED will flash when the washer has run 30 wash cycles as a reminder to run the Clean Washer with affresh® cycle.

See “Cycle Guide” for detailed descriptions of cycles.

NOTE: For best results when using the Overnight Wash & Dry cycle, use for loads weighing 2.5 pounds and less, such as a soccer uniform or a running tank and shorts.

3. START

Touch and hold until the light above START comes on to start a cycle, or touch once while a cycle is in process to pause it. If you want to add a garment, you can touch START when the “Add a Garment” LED is on.

4. LED DISPLAY AND SETTINGS

When you select a cycle, its default settings will light up and the Estimated Cycle Time will be displayed. Factors such as load size, wash temperature, and water pressure may affect



the time shown in the display during the cycle. Tightly packing garments, unbalanced loads, or excessive suds may cause the washer to adjust the cycle time, as well.

Touch the desired setting along the right of the display to adjust. See “Cycle Guide” for available settings on each cycle. Not all settings are available with all cycles.

Temperature

The recommended wash temperature is preset for each cycle. You may also select a wash temperature based on the type of fabric and soils being washed. For best results, follow the garment label instructions. All wash temperatures feature a cold rinse.

Soil Level

The Soil Level setting (wash time) is preset for each wash cycle. For most loads, use this preset soil level. When you change the soil setting, the cycle time will increase or decrease in the Estimated Cycle Time display.

For heavily soiled and sturdy fabrics, use the Soil Level setting to select more wash time. For lightly soiled and delicate fabrics, use the Soil Level setting to select less wash time. Lower soil level settings will help reduce tangling and wrinkling.

Spin Speed

This washer automatically selects the spin speed based on the cycle selected. Some preset speeds can be changed.

- Higher spin speeds mean shorter dry times, but may increase wrinkling in your load.
- Lower spin speeds reduce wrinkling, but will leave your load more damp.

5. DELAY START

Use + and – to delay the start of the wash cycle by 9 to 12 hours, depending on model. To turn off Delay Start, use + and – to set the delay time to “0,” or touch POWER/CANCEL.

6. CYCLE STATUS LIGHTS

NOTE: Not all Cycle Status Lights are available on all models.

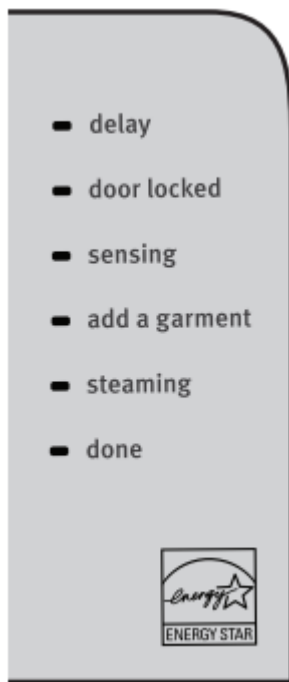

Delay

If a Delay Start is set, the Delay indicator will light and the delay time will count down in the display.

Door Locked

Door Locked will light to indicate that the door is locked and cannot be opened without first pausing or canceling the cycle.

Sensing

When START is touched and held, the washer will first perform a self-test on the door lock mechanism and the sensing light will come on. You will hear a click, the drum will make a partial turn, and the door will click again as it unlocks briefly. The door will click one more time when it locks again.

Once the door has locked the second time, the washer will begin tumbling and adding water. This sensing process will continue throughout the cycle. You may also hear water flowing through the dispenser, adding detergent to the load.

After the load size is sensed, the estimated time based on load size will be displayed. The actual cycle time may be lengthened; however, the display will continue to show the estimated time.

The sensing light will blink once a second at various times during the cycle, such as when the washer is reducing extra suds.

Add a Garment

When "Add a Garment" is lit, you may pause the washer, open the door, and add items. Touch and hold START to start the washer again.

Steaming

This will light to show that the cycle is using a steam boost for added cleaning power.

Done

Once the cycle is complete, this light will come on. Remove the load promptly for best results. The Done indicator is also lit during Fresh Hold® or Fresh Spin™ option.

7. OPTIONS

Touch to activate additional wash options or additional features on the washer. Not all options are available on all models.

A. Fresh Hold® Option (on some models)

The Fresh Hold® option will periodically tumble the load after the end of the cycle for 12 hours while the integrated fan circulates air through the washer to reduce humidity. To turn on the Fresh Hold® option, touch Fresh Hold. If, however, the Fresh Hold® option is turned on, it will stay on for all future cycles until turned back off – the washer remembers the last on/off status set. To turn off the Fresh Hold® option, touch Fresh Hold.

You may also activate the Fresh Hold® option without running a cycle by touching and holding POWER/CANCEL for one second, then touching and holding Fresh Hold for 3 seconds, then touching and holding START for 3 seconds.

To turn off the Fresh Hold® option when it is running, touch POWER/CANCEL.

NOTE: The door will lock while the Fresh Hold® option is active. To cancel the option and unlock the door, touch POWER/CANCEL.

A. Fresh Spin™ Option (on some models)

The Fresh Spin™ option will periodically tumble the load after the end of the cycle for up to 6 hours to reduce humidity. To turn on the Fresh Spin™ option, touch Fresh Spin. If, however, the Fresh Spin™ option is turned on, it will stay on for all future cycles until turned back off – the washer remembers the last on/off status set. To turn off the Fresh Spin™ option, touch Fresh Spin.

You may also activate the Fresh Spin™ option without running a cycle by touching and holding POWER/CANCEL for one second, then touching and holding Fresh Spin for 3 seconds, then touching and holding START for 3 seconds.

To turn off the Fresh Spin™ option when it is running, touch POWER/CANCEL.

NOTE: The door will lock while the Fresh Spin™ option is active. To cancel the option and unlock the door, touch POWER/CANCEL.

B. Steam for Stains

The Steam for Stains option adds additional soak and wash time to many cycles to help remove tough stains, as well as a steam boost for added cleaning power. An integrated heater helps to maintain optimal wash temperatures. See the “Cycle Guide” for cycles that allow the Steam for Stains option.

C. Extra Rinse

Activate this option to add an extra rinse to most cycles.

D. Cycle Signal

Use this option to turn on or off the signal that sounds at end of cycle.

To turn off the tones that sound when a setting is touched: Touch and hold CYCLE SIGNAL for about 3 seconds. Repeat to turn them on.

E. Control Lock

Touch and hold for 3 seconds to lock the controls to avoid unwanted changes or operation. Touch and hold 3 seconds again to unlock. For each second CONTROL LOCK is held down, the display will count down one second: you will see “3,” then “2,” then “1.” You may still touch START to pause the cycle, or touch POWER/CANCEL to turn off the washer.

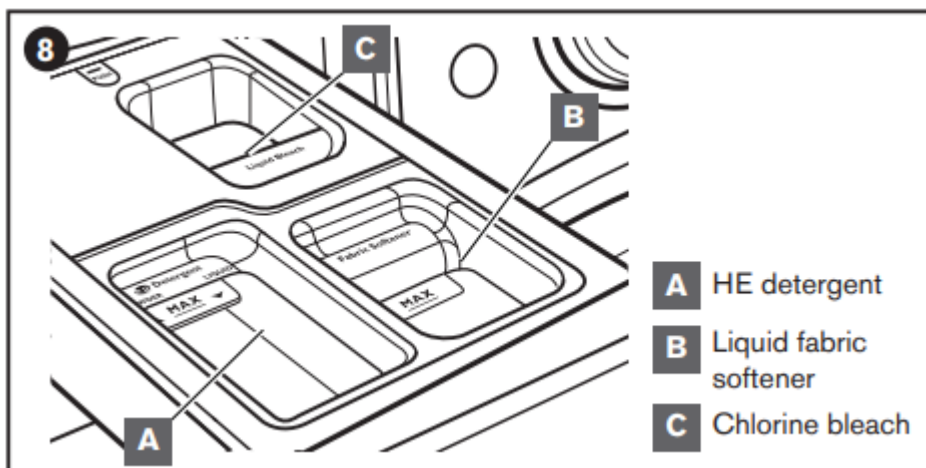

8. DISPENSER DRAWER

The dispenser drawer gives you the convenience of automatically adding HE detergent, liquid chlorine bleach, and liquid fabric softener to the wash load at the proper time. See “Using the Dispenser Drawer” for information on using the dispenser drawer.

A. High Efficiency “HE” detergent compartment

This compartment holds liquid or powdered HE detergent for your main wash cycle.

B. Liquid fabric softener compartment

Automatically dilutes and dispenses liquid fabric softener at the optimum time in the cycle.

Use only liquid fabric softener in this dispenser.

C. Liquid chlorine bleach compartment

Automatically dilutes and dispenses liquid chlorine bleach at the optimum time during the first rinse after the wash cycle. This compartment cannot dilute powdered bleach.

Choosing the Right Detergent

Use only High Efficiency detergents. The package will be marked “HE” or “High Efficiency.” Low-water washing creates excessive sudsing with a non-HE detergent. Using non-HE detergent will likely result in longer cycle times and reduced rinsing performance. It may also result in component failure and, over time, buildup of mold or mildew. HE detergents are low-sudsing and quick-dispersing to produce the right amount of suds for the best performance. They hold soil in suspension so it is not re-deposited onto clean clothes. Follow the manufacturer’s instructions to determine the amount of detergent to use.



Use only High Efficiency (HE) detergent.

USING THE DISPENSER DRAWER

1. Open the dispenser drawer.
2. Add laundry products as described in steps 4–6 in the “Using Your Washer” section.
3. Slowly close the dispenser drawer. Make sure it is completely closed.

NOTE: A small amount of water may remain in the dispensers from the previous wash cycle. This is normal.

Adding HE detergent to dispenser

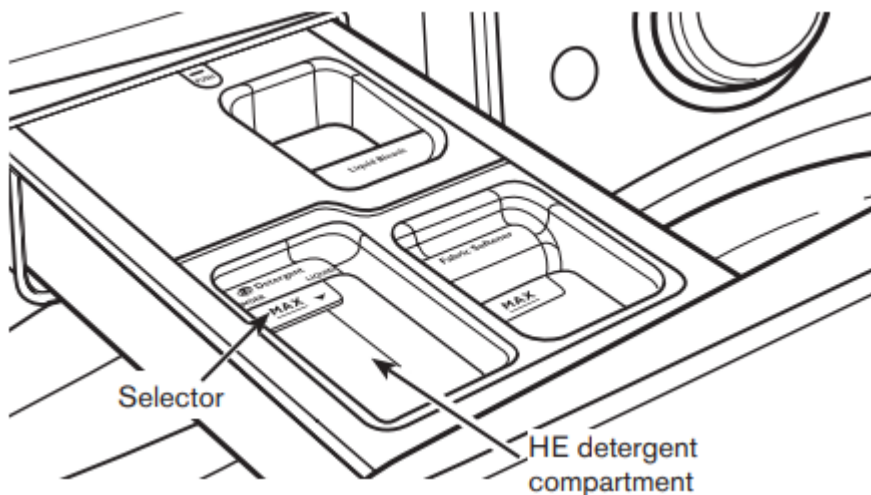

Pour a measured amount of HE detergent into detergent compartment. For powdered detergent, lift the selector to the high position. For liquid detergent, push down the selector to the low position.



Use only High Efficiency (HE) detergent.

Powdered detergent:

Lift the selector to the high position.

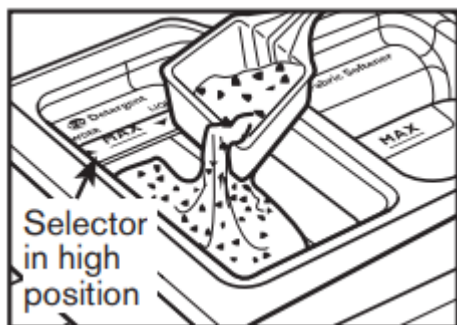

Liquid detergent:

Push down the selector to the low position

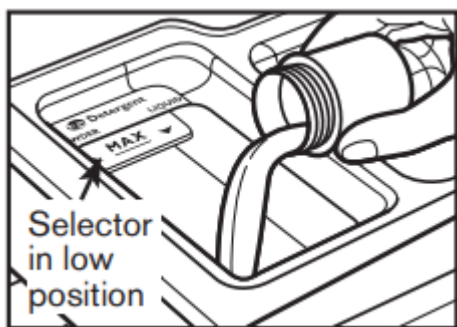

Do not overfill; adding too much detergent may cause detergent to be dispensed into the washer too early.

IMPORTANT:







- Do not add single-dose laundry packet to dispenser drawer.
- Use powdered detergent when using the Delay Start option. Liquid detergent may seep out before the wash begins.

CYCLE GUIDE







Settings and options shown in bold are default settings for that cycle. For best fabric care, choose the cycle, options, and settings that best fit the load being washed. Not all settings are available with each cycle, and some options cannot be used together.

NOTES:

- Not all cycles and options are available on all models
- All wash temperature selections feature a cold rinse.
- Not all temperatures or spin speeds are labeled on the control panel

Items to wash using default cycle settings:	Cycle:	Wash Temperature:	Spin Speed:	Soil Level:	Available Options:	Cycle Details:
Normally soiled cottons, linens, sheets, and mixed garment loads	Normal	Extra Hot Hot Warm Cool Cold	Max Extract™/ Extra High High Med None	Extra Heavy Heavy Med Light	Steam for Stains* Fresh Hold®/ Fresh Spin™ Extra Rinse Delay Start	 This cycle combines medium-speed tumbling and an extra-high-speed spin. This cycle is designed to provide the most energy efficiency.
Bright or darkly colored cottons, linens, casual and mixed loads.	Cold Wash	Cold	Max Extract™/ Extra High High Med None	Extra Heavy Heavy Med Light	Fresh Hold®/ Fresh Spin™ Extra Rinse Delay Start	 This cycle uses a concentrated detergent solution along with cold water throughout the cycle to gently lift out stains and care for fabrics.
Lightly soiled shirts, blouses, trousers, pants, and dresses	Wrinkle Control	Extra Hot Hot Warm Cool Cold	Max Extract™/ Extra High High Med Low None	Extra Heavy Heavy Med Light	Steam for Stains* Fresh Hold®/ Fresh Spin™ Extra Rinse Delay Start	 This cycle combines low-speed tumbling and medium-speed spin for gentle fabric care and reduced wrinkling.
Sheer fabrics, lingerie, sweaters, and lightly-soiled shirts, blouses, trousers, pants, and skirts	Delicates	Extra Hot Hot Warm Cool Cold	Max Extract™/ Extra High High Med Low None	Extra Heavy Heavy Med Light	Steam for Stains* Fresh Hold®/ Fresh Spin™ Extra Rinse Delay Start	 This cycle combines low-speed tumbling and low-speed spin for gentle fabric care and reduced wrinkling.
Normally soiled sheets, pillowcases, light blankets, or throws	Bedding	Extra Hot Hot Warm Cool Cold	Max Extract™/ Extra High High** Med Low None	Extra Heavy Heavy Med Light	Steam for Stains* Fresh Hold®/ Fresh Spin™ Extra Rinse Delay Start	 The wash action of this cycle is designed to keep large items from tangling and balling up.
Small loads of 2–4 lightly soiled garments	Rapid Wash	Extra Hot Hot Warm Cool Cold	Max Extract™/ Extra High High Med Low None	Extra Heavy Heavy Med Light	Steam for Stains* Fresh Hold®/ Fresh Spin™ Extra Rinse Delay Start	 For small loads (2–4 items) needed quickly. This cycle combines high-speed tumbling, a shortened wash time, and an extra-high-speed spin for reduced drying times.
No clothes in washer	Clean Washer with affresh®				Fresh Hold®/ Fresh Spin™ Delay Start	Use this cycle every 30 washes to keep the inside of your washer fresh and clean. This cycle uses a higher water level. Use with affresh® washer cleaner tablet or liquid chlorine bleach to thoroughly clean the inside of your washer. This cycle should not be interrupted. See "Washer Care." IMPORTANT: Do not place garments or other items in the washer during the Clean Washer with affresh® cycle. Use this cycle with an empty wash tub. See "Washer Care" in "Washer Maintenance."



Items to wash using default cycle settings:	Cycle:	Wash Temperature:	Spin Speed:	Soil Level:	Available Options:	Cycle Details:
Wet load of clothes	Drain & Spin	N/A	Max Extract™/ Extra High High Med Low None	N/A	Fresh Hold®/ Fresh Spin™ Delay Start	 Use Drain & Spin to remove excess water from the load. Spin speed can be set to a lower setting.
Swimwear, items that need rinsing	Drain & Spin with Extra Rinse	Extra Hot Hot Warm Cool Cold	Max Extract™/ Extra High High Med Low None	Extra Heavy Heavy Med Light	Fresh Hold®/ Fresh Spin™ Delay Start	 Select Drain & Spin; then select Extra Rinse to add water. The cycle includes an extra-high-speed spin. For some fabrics, you may wish to set the spin speed to a lower setting.
Clothing, bedding and towels requiring sanitization	Sanitize	Extra Hot	Max Extract™/ Extra High High Med Low None	Extra Heavy Heavy Med Light	Steam for Stains* Fresh Hold®/ Fresh Spin™ Extra Rinse Delay Start	 This cycle eliminates 99.99% of the most common bacteria found in clothes, sheets, and towels. The extra hot wash temperature ensures sanitization. Check recommended wash temperature of your items. Bacteria tested were K. pneumonia, P. aureginosa, and S. aureus.
Sturdy garments and household items exposed to possible allergens	Allergen†	Extra Hot Hot	Max Extract™/ Extra High High Med	Extra Heavy Heavy Med Light	Steam for Stains* Fresh Hold®/ Fresh Spin™ Extra Rinse Delay Start	 Uses more water to flush out allergens such as dust mites and pet dander from normally-soiled items.
2–4 lightly soiled synthetic garments, athletic uniforms, or workout wear	Overnight Wash & Dry	Extra Hot Hot Warm Cool Cold	Max Extract™/ Extra High	Extra Heavy Heavy Med Light	Steam for Stains* Fresh Hold® Extra Rinse Delay Start	 This short wash cycle has an extra-high-speed spin followed by intermittent tumbling and fan activation to circulate air through the clothes.
Heavily soiled fabrics	Power Wash	Extra Hot Hot Warm Cool Cold	Max Extract™/ Extra High High Med Low None	Extra Heavy Heavy Med Light	Steam for Stains* Fresh Hold®/ Fresh Spin™ Extra Rinse Delay Start	 Use this cycle for extremely soiled garments and household items that need additional cleaning power.

* Steam for Stains option is only available when warm, hot, or extra hot water temperature is selected.

** On some models, the default is Extra High.

Load Size Recommendations

For best results, follow the load size recommendations noted for each cycle.



Small load: Fill the washer drum with 3–4 items, not more than 1/4 full.



Medium load: Fill the washer drum up to about 1/2 full.



Large load: Fill the washer drum up to about 3/4 full.



Extra-large load: Fill the washer drum, but make sure clothes can tumble freely. For best results, avoid packing tightly.

USING YOUR WASHER

WARNING: Fire Hazard

- Never place items in the washer that are dampened with gasoline or other flammable fluids.
- No washer can completely remove oil.
- Do not dry anything that has ever had any type of oil on it (including cooking oils).
- Doing so can result in death, explosion, or fire.

WARNING: Electrical Shock Hazard

- Plug into a grounded 3 prong outlet
- Do not remove ground prong
- Do not use an adapter
- Do not use an extension cord
- Failure to follow these instructions can result in death, fire, or electrical shock.

First wash cycle without laundry

Before washing clothes for the first time, if not completed during the final installation step, choose the NORMAL cycle and run it without clothes. Use only HE detergent. Use 1/2 the manufacturer's recommended amount for a medium-size load. This initial cycle serves to ensure the interior is clean before washing clothes.

1. Sort and prepare your laundry

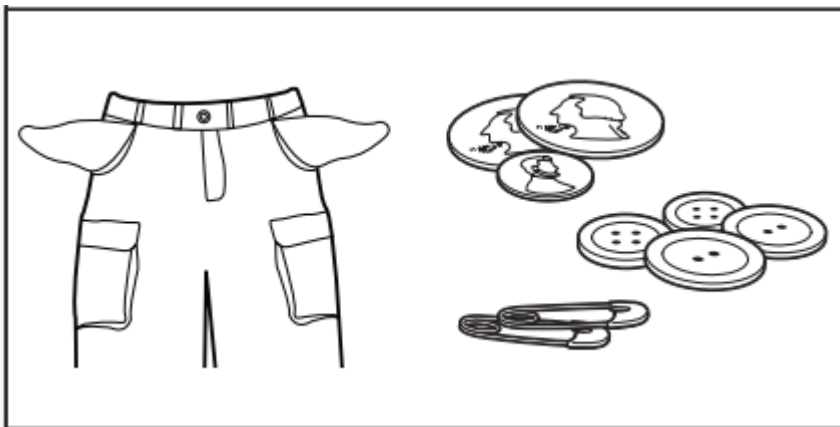

Sort items by recommended cycle, water temperature, and colorfastness. Separate heavily soiled items from lightly soiled. Separate delicate items from sturdy fabrics. Treat stains promptly and check for colorfastness by testing stain remover products on an inside seam.

IMPORTANT:

- Empty pockets. Loose change, buttons, or any small object can plug pumps and may require a service call.

- Close zippers, fasten hooks, tie strings and sashes, and remove non-washable trim and ornaments.
- Mend rips and tears to avoid further damage to items during washing.
- Turn knits inside out to prevent pilling. Separate lint-takers from lint-givers. Synthetics, knits, and corduroy fabrics will pick up lint from towels, rugs, and chenille fabrics.
- Do not dry garments if stains remain after washing, because heat can set stains into fabric.
- Always read and follow fabric care labels and laundry product instructions. Improper usage may cause damage to your garments.

2. Add laundry products

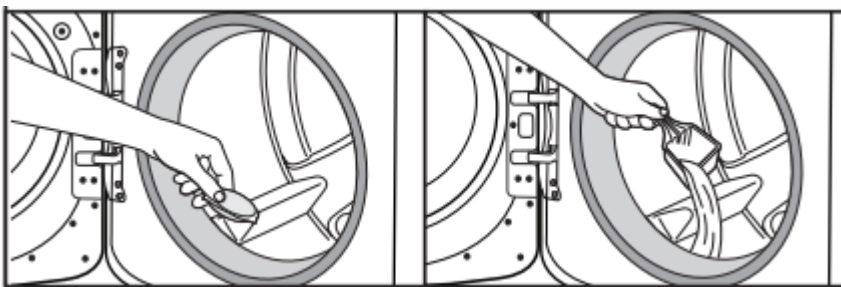

Single-dose laundry packet, Oxi-type boosters, color-safe bleach, or fabric softener crystals can be added to the drum prior to adding laundry.

NOTE: Do not add clothes to washer drum prior to adding laundry products. Always follow manufacturer's instructions.

3. Load laundry into washer

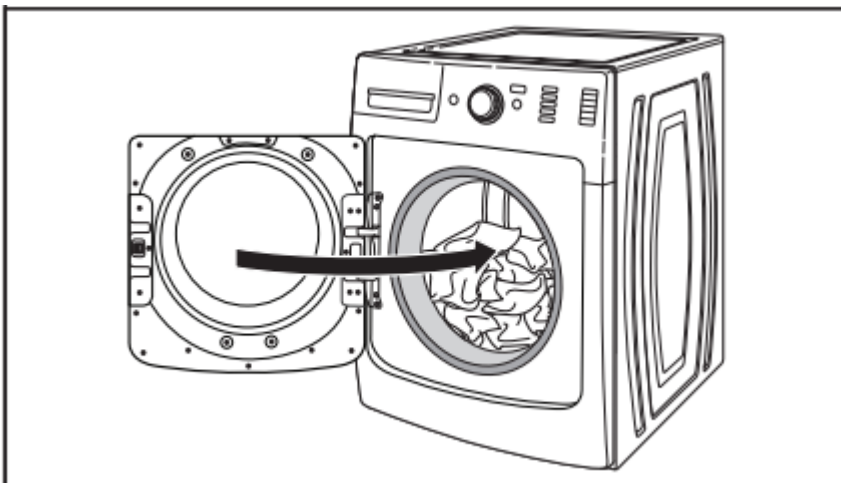

Place a load of sorted clothes loosely in the washer. Items need to move freely for best cleaning and to reduce wrinkling and tangling. Close the washer door by pushing it firmly until the latch clicks.

- Depending on load type and cycle, the washer can be fully loaded, but not tightly packed. Washer door should close easily. See “Cycle Guide” for loading suggestions.
- Mix large and small items and avoid washing single items. Load evenly.
- Wash small items in mesh garment bags. For multiple items, use more than one bag and fill bags equally

USING LAUNDRY PRODUCT DISPENSERS

NOTE: Do not add single-dose laundry packets, Oxi-type boosters, color-safe bleach, or fabric softener crystals to dispensers. They will not dispense correctly

4. Add HE detergent

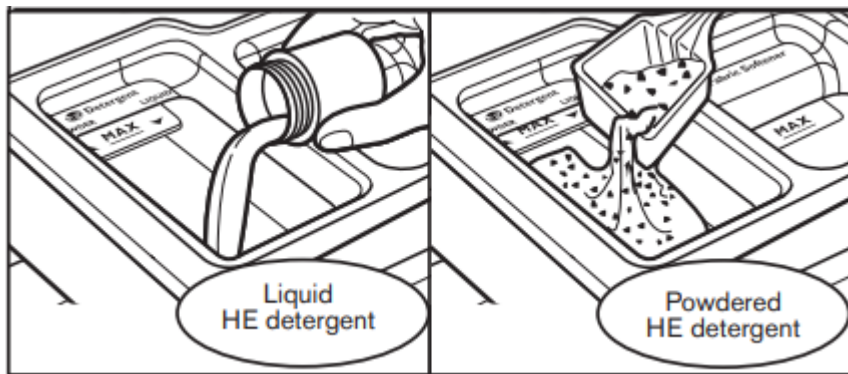

Adjust the selector, based on type of HE detergent used (either liquid or powdered). See “Using the Dispenser Drawer” instructions on how to use the dispenser.

5. Add liquid fabric softener to dispenser (if desired)

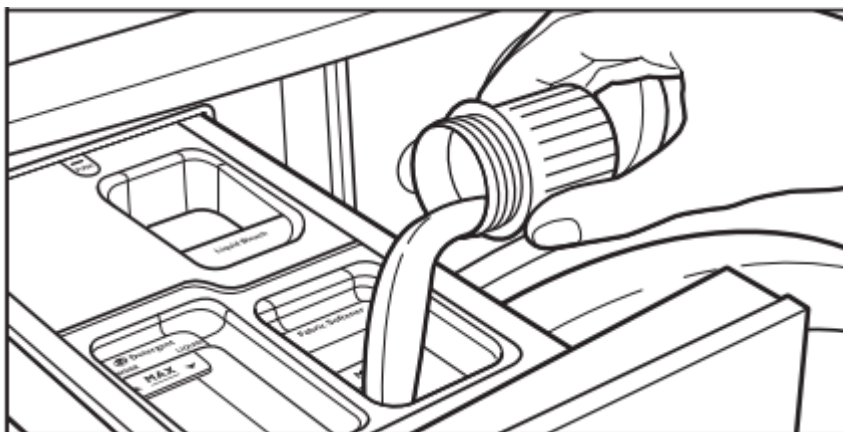

Pour a measured amount of liquid fabric softener into liquid fabric softener compartment. Always follow manufacturer’s directions for correct amount of fabric softener based on your load size.

Fabric softener is always dispensed in the last rinse, even if Extra Rinse is selected.

IMPORTANT: Do not overfill, dilute, or use more than ¼ cup (60 mL) of fabric softener. Do not fill past the MAX line. Overfilling dispenser will cause fabric softener to immediately dispense into washer.

- Do not spill or drip any fabric softener onto the clothes.
- Do not use liquid fabric softener dispenser balls in this washer. They will not dispense correctly

6. Add liquid chlorine bleach to dispenser (if desired)

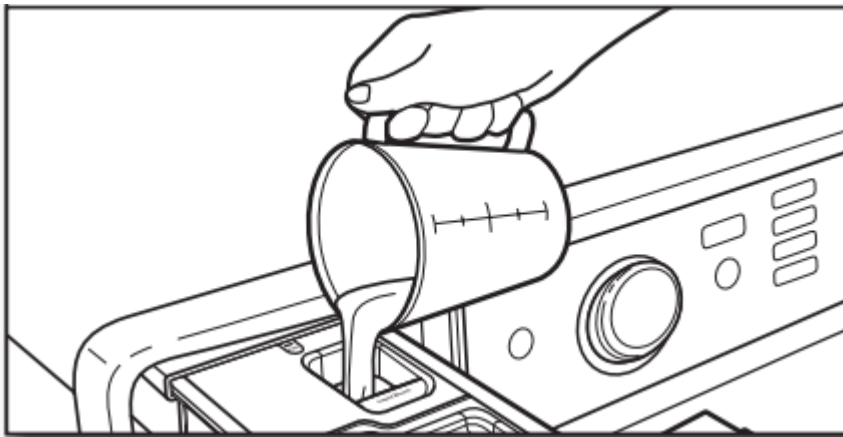

Add liquid chlorine bleach to the bleach compartment. Do not overfill, dilute, or use more than 2/3 cup (165 mL). Do not use color-safe bleach or Oxi in the same cycle with liquid chlorine bleach.

- Always measure liquid chlorine bleach. Use a measuring cup with a pour spout; do not guess.
- Do not fill beyond the “MAX” level. Overfilling could cause garment damage.

7. Touch POWER/CANCEL to turn on washer (optional)

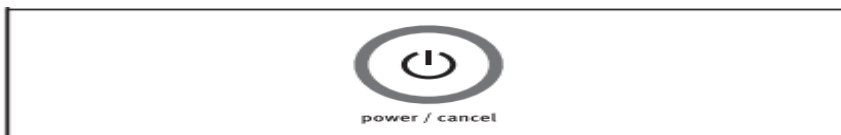

Slowly close the dispenser drawer. Make sure the drawer is closed completely, then touch POWER/CANCEL to turn on the washer or go to Step 8.

8. Select CYCLE*

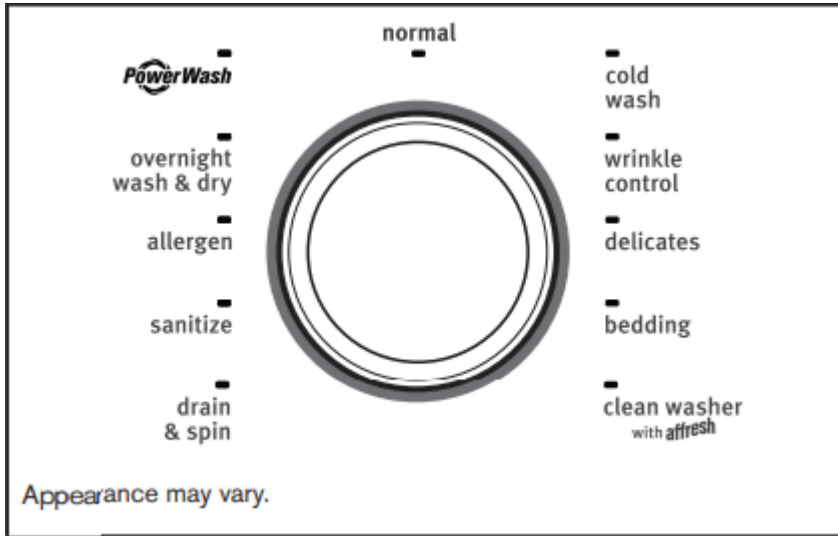

Turn cycle knob to select your wash cycle. See “Cycle Guide” for details on cycle features.

9. Adjust settings, if desired*

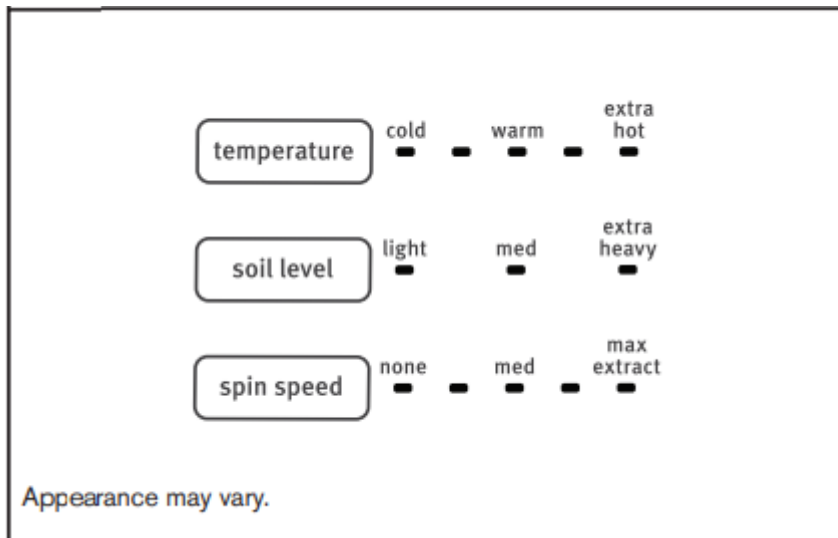

The display will show the default settings for the selected cycle. To adjust a setting, touch its name – Temperature, Soil Level, or Spin Speed. Adjusting settings will change the Estimated Cycle Time. Tightly packing the load, unbalanced loads, or excessive suds may also cause the washer to increase the cycle time.

10. Select any additional options*

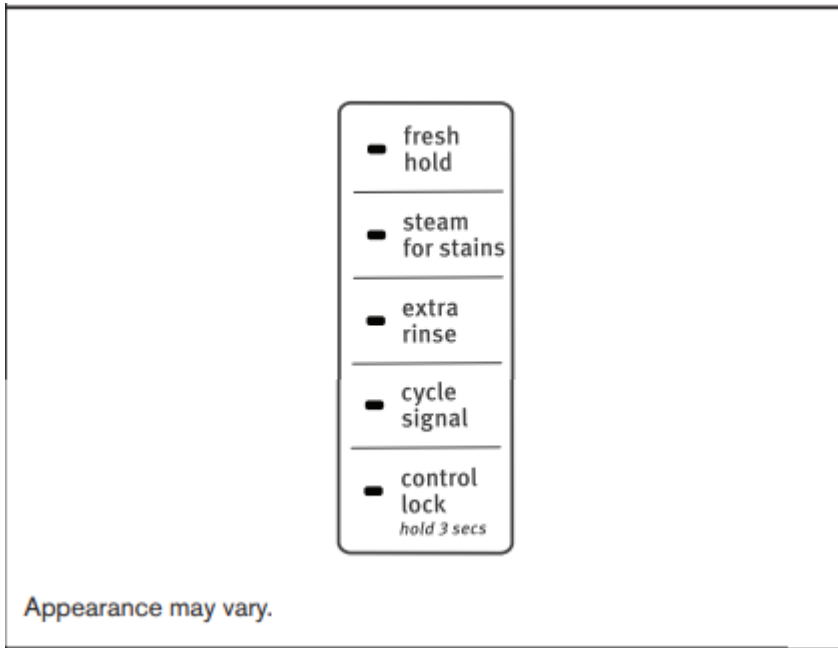

To add an option to the cycle, touch its name – Fresh Hold/Fresh Spin, Steam for Stains, Extra Rinse, Cycle Signal, or Control Lock. To remove an option from the selected cycle, touch the option again.

11. Setting a delayed start

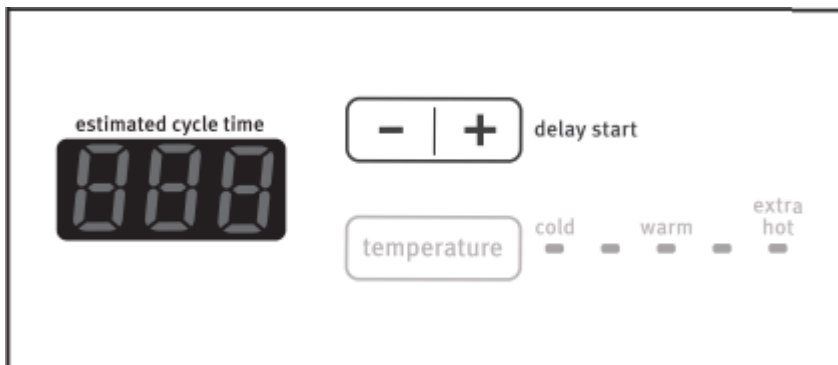

If you do not want to begin a cycle immediately, you may choose the DELAY START option. This will delay the start of the wash cycle by 9 to 12 hours.

To set a delayed start:

1. Touch DELAY START + and – buttons to set the desired delay time.
2. Touch and hold START to set the delay. The delay countdown has started when the START light stops blinking

12. Touch and hold START to begin wash cycle



Touch and hold START to start the wash cycle. To pause a cycle in progress, touch START once, then touch and hold again to continue the cycle. To cancel a cycle, touch POWER/CANCEL.

Once you touch and hold START, you will hear the door lock, unlock, and lock again. The washer door will remain locked during the wash cycle.

Unlocking the door to add garments:

If you need to open the door to add 1 or 2 missed garments, you may do so while the "Add a Garment" light is lit.



Touch START once; the door will unlock once the washer movement has stopped. This may take several minutes. Then close door and touch and hold START again to restart the cycle.



13. Remove garments promptly after cycle is finished

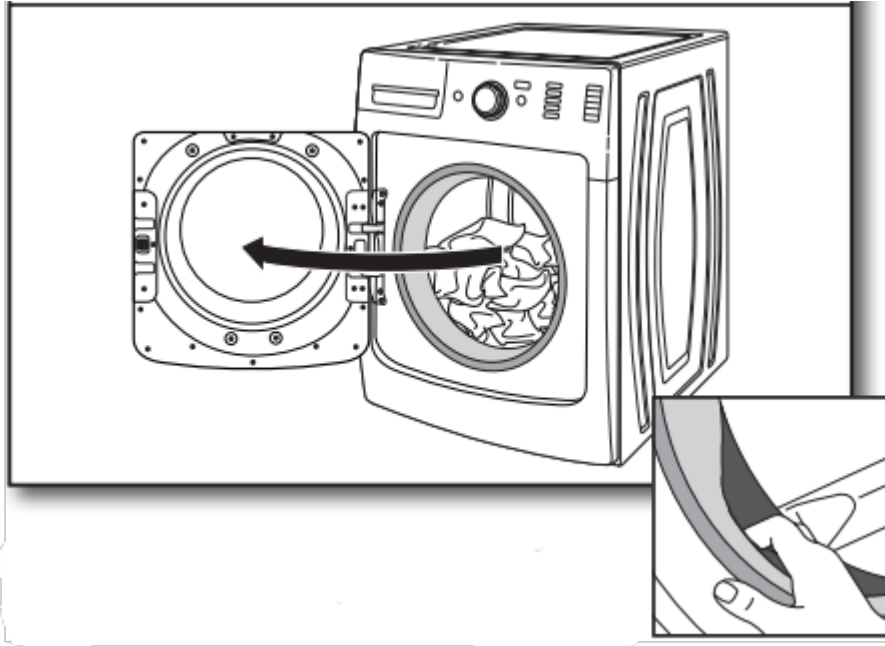

Promptly remove garments after cycle has completed to avoid odor and rusting of metal objects on garments. When unloading garments, pull back the door seal and check for small items between the tub and the washer drum.

If you will be unable to remove the load promptly, use the Fresh Hold® or Fresh Spin™ option (depending on model). If selected, the Fresh Hold® option will activate the fan and tumble the load periodically for up to 12 hours. The Fresh Spin™ option will tumble the load periodically for up to 6 hours. To turn off the Fresh Hold® or Fresh Spin™ option, touch POWER/CANCEL. To set the washer so that the Fresh Hold®/ Fresh Spin™ option does not come on for future cycles, touch Fresh Hold® or Fresh Spin™ option.

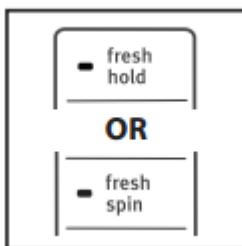

NOTE:

- The door will remain locked while the Fresh Hold®/Fresh Spin™ option is active. To cancel the option and unlock the door, touch POWER/CANCEL.
- A small amount of water may remain in the dispensers after the wash cycle is complete. This is normal.
- This washer has a tight seal to avoid water leaks. To avoid odors, leave the door open to allow the washer to dry between uses.

WASHER MAINTENANCE

WATER INLET HOSES

Replace inlet hoses after 5 years of use to reduce the risk of hose failure. Periodically inspect and replace inlet hoses if bulges, kinks, cuts, wear, or leaks are found.

When replacing your inlet hoses, mark the date of replacement on the label with a permanent marker.

WASHER CARE

Recommendations to Help Keep Your Washer Clean and Performing at its Best

1. Always use High Efficiency (HE) detergents and follow the HE detergent manufacturer's instructions regarding the amount of HE detergent to use. Never use more than the recommended amount because that may increase the rate at which detergent and soil residue accumulate inside your washer, which in turn may result in undesirable odor.
2. Use warm or hot water washes sometimes (not exclusively cold water washes), because they do a better job of controlling the rate at which soils and detergent accumulate.
3. Always leave the washer door slightly ajar between uses to help dry out the washer and avoid the buildup of odor-causing residue.
4. Periodically clean residue from the underside of the glass window.

Cleaning Your Front Loading Washer

Read these instructions completely before beginning the routine cleaning processes recommended below. This Washer Maintenance Procedure should be performed, at a minimum, once per month or every 30 wash cycles, whichever occurs sooner, to control the rate at which soils and detergent may otherwise accumulate in your washer.

Cleaning the Door Seal

1. Open the washer door and remove any clothing or items from the washer.
2. Inspect the colored seal between the door opening and the drum for stained areas or soil buildup. Pull back the seal to inspect all areas under the seal and to check for foreign objects.
3. If stained areas or soil buildup are found, wipe down these areas of the seal using either of the following two procedures:
 - a. **affresh® Grit Grabber™ Cloth Procedure:**
 - i. When the cycle is complete, gently pull back the rubber door seal and clean the entire surface with the rough side of the Grit Grabber™ cloth.
 - b. **Dilute Liquid Chlorine Bleach Procedure:**

- i. Mix a dilute bleach solution, using $\frac{3}{4}$ cup (177 mL) of liquid chlorine bleach and 1 gallon (3.8 L) of warm tap water.
- ii. Wipe the seal area with the dilute solution, using a damp cloth.
- iii. Let stand 5 minutes. iv. Wipe down area thoroughly with a dry cloth and let washer interior air dry with door open.

IMPORTANT:

- Wear rubber gloves when cleaning with bleach.
- Refer to the bleach manufacturer's instructions for proper use.

Cleaning the Inside of the Washer

This washer has a special cycle that uses higher water volumes in combination with affresh® Washer Cleaner or liquid chlorine bleach to thoroughly clean the inside of the washer. Steam washer models also utilize steam to enhance cleaning in this special cycle.

NOTE: Read these instructions completely before beginning the cleaning process.

Begin procedure

1. Clean Washer with affresh® Cycle Procedure (Recommended for Best Performance):

- a. Open the washer door and remove any clothing or items.
- b. Add an affresh® Washer Cleaner tablet to the washer drum.
- c. Do not add the affresh® Washer Cleaner tablet to the dispenser drawer.
- d. Do not add any detergent or other chemical to the washer when following this procedure.
- e. Close the washer door.
- f. Select the Clean Washer with affresh® cycle.
- g. On some models: Select the Fresh Hold®/Fresh Spin™ option to help dry the washer interior after the cycle is complete. NOTE: The washer remembers your last option selection and will use it for future wash cycles until you deselect that option. While the fan is on, the washer door will lock. To unlock the door, touch POWER/CANCEL.
- h. Touch and hold START to begin the cycle. The Clean Washer with affresh® Cycle Operation is described below.

2. Chlorine Bleach Procedure:

- a. Open the washer door and remove any clothing or items.

b. Open the dispenser drawer and add liquid chlorine bleach to the MAX level in both the bleach compartment and the fabric softener compartment. Either traditional or HE chlorine bleach can be used.

NOTE: Use of more liquid chlorine bleach than is recommended above could cause washer damage over time.

c. Close the washer door and the dispenser drawer.

d. Do not add any detergent or other chemicals to the washer when following this procedure.

e. Close the washer door.

f. Select the Clean Washer with affresh® cycle.

g. On some models: Select the Fresh Hold®/Fresh Spin™ option to help dry the washer interior after the cycle is complete. NOTE: The washer remembers your last option selection and will use it for future wash cycles until you deselect that option. While the fan is on, the washer door will lock. To unlock the door, touch POWER/CANCEL.

h. Touch and hold START to begin the cycle. The Clean Washer with affresh® Cycle Operation is described below.

NOTE: For best results, do not interrupt cycle.

Description of Clean Washer with affresh® Cycle Operation:

1. The Clean Washer with affresh® cycle. will determine whether clothing or other items are in the washer.

2. If no items are detected in the washer, it will proceed with the cycle.

a. If any items are detected in the washer, “rL” (remove load) will be displayed. The door will unlock. Open washer and remove any garments from the washer drum.

b. Touch POWER/CANCEL to clear the “rL” code.

c. Touch and hold START to restart the cycle.

3. Steam models only: During the first 20 minutes of the cycle, it will activate the steamer but the drum will not spin or fill with water. You may see condensation on the door glass during this initial phase. If you are using an affresh® Washer Cleaner tablet, it will not dissolve completely during the steam phase. This is normal.

After the cycle is complete, leave the door open slightly to allow for better ventilation and drying of the washer interior.

Cleaning the Dispensers

After a period of using your washer, you may find some residue buildup in the washer's dispensers. To remove residue from the dispensers, remove the drawer and wipe the surfaces with a damp cloth and towel dry either before or after you run the Clean Washer with affresh® cycle. Use an all-purpose surface cleaner, if needed.

IMPORTANT: Dispenser is not dishwasher safe.

Cleaning the Outside of the Washer

Use a soft, damp cloth or sponge to wipe up any spills. Occasionally wipe the outside of your washer to help keep it looking new. Use mild soap and water.

IMPORTANT: To avoid damaging the washer's finish, do not use abrasive products.

CLEAN WASHER CYCLE REMINDER

NOTE: Not all models have the Clean Washer with affresh® cycle reminder light:



The Clean Washer with affresh® LED will flash at the end of a wash cycle when the washer has run 30 wash cycles. This is a reminder to run the Clean Washer with affresh® cycle.

If the Clean Washer with affresh® cycle is not turned on, the LED will stop flashing at the end of a wash cycle after running 3 more regular wash cycles. After 30 more wash cycles are completed, the Clean Washer with affresh® LED will again flash at the end of a wash cycle as a reminder.

REMOVING THE DISPENSER

To remove:

1. Pull dispenser drawer out until it stops.

2. Press down on the release tab and pull straight out to remove the dispenser.

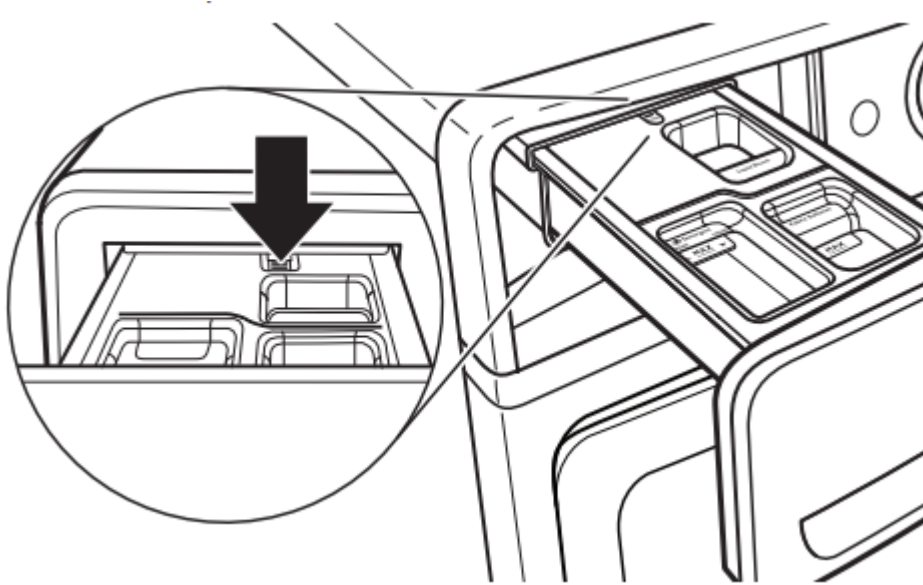

3. Lift off cover panel by pulling straight up.

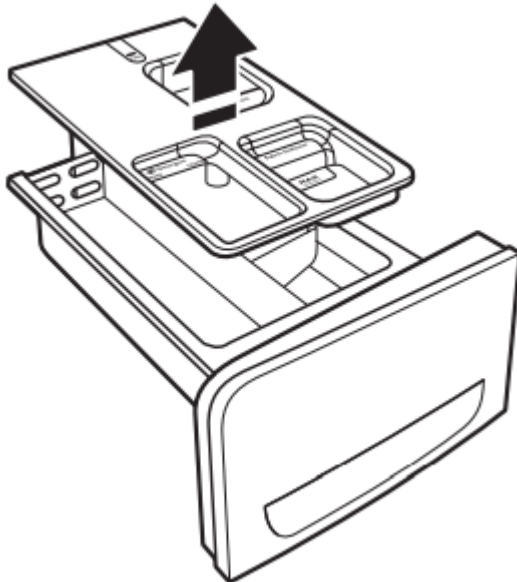

To replace:

1. Slide cover panel back onto posts on dispenser.



2. Align edges of dispenser with guides in washer, then slide dispenser back into slot.

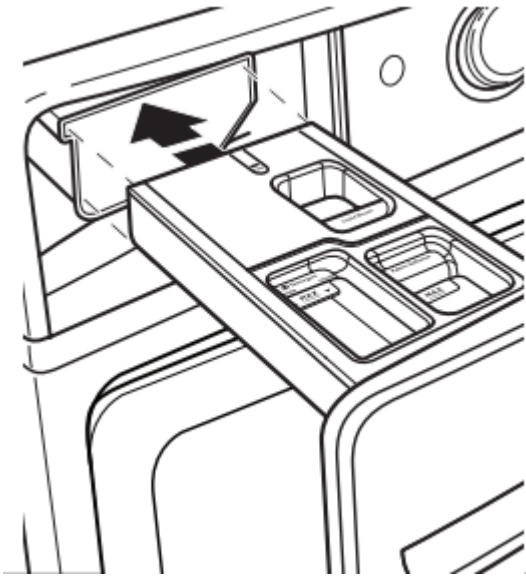

NON-USE AND VACATION CARE

Operate your washer only when you are home. If moving, or not using your washer for a period of time, follow these steps:

1. Unplug or disconnect power to washer.
2. Turn off water supply to washer to avoid flooding due to water pressure surges.
3. Clean dispensers. See “Cleaning the Dispensers.”

WINTER STORAGE CARE

IMPORTANT: To avoid damage, install and store washer where it will not freeze. Because some water may stay in hoses, freezing can damage washer. If storing or moving during freezing weather, winterize your washer.

To winterize washer:

1. Shut off both water faucets, disconnect and drain water inlet hoses.
2. Put 1 qt. (1 L) of R.V.-type antifreeze in washer drum and run washer on NORMAL cycle for about 2 minutes to mix antifreeze and remaining water.
3. Unplug washer or disconnect power.

TRANSPORTING YOUR WASHER

1. Shut off both water faucets. Disconnect and drain water inlet hoses.
2. If washer will be moved during freezing weather, follow WINTER STORAGE CARE directions before moving.
3. Disconnect drain hose from drain system and from back of washer.
4. Unplug power cord.

5. Place inlet hoses and drain hose inside washer drum.
6. Bundle power cord with a rubber band or cable tie to keep it from hanging onto the ground.

IMPORTANT: Call for service to install new transport bolts. Do not reuse transport bolts. Washer must be transported in the upright position. To avoid structural damage to your washer, it must be properly set up for relocation by a certified technician.

REINSTALLING/USING WASHER AGAIN

To reinstall washer after non-use, vacation, winter storage, or moving:

1. Refer to Installation Instructions to locate, level, and connect washer.
2. Before using again, run washer through the following recommended procedure:

To use washer again:

1. Flush water pipes and hoses. Reconnect water inlet hoses. Turn on both water faucets.
2. Plug in washer or reconnect power.
3. Run washer through NORMAL cycle to clean washer and remove antifreeze, if used. Use only HE detergent. Use half the manufacturer's recommended amount for a medium-size load.

WARNING: Electrical Shock Hazard

- Plug into a grounded 3 prong outlet
- Do not remove ground prong
- Do not use an adapter
- Do not use an extension cord
- Failure to follow these instructions can result in death, fire, or electrical shock.

TROUBLESHOOTING



If you experience	Possible Causes	Solution
Error Code Appears in Display		
Once any possible issues are corrected, touch POWER/CANCEL once to clear the code. Reselect and restart the cycle.		
"Sud" (Excess suds) appears in display	Excessive suds in washer. Washer is running a suds reduction routine.	Allow the washer to continue. Use only HE detergent, and base detergent. Follow detergent manufacturer's instructions.
Lo followed by FL or F8 followed by E1 (water supply error) appears in display	Check for proper water supply.	Unit will drain for 8 minutes while door remains closed. If drain cycle is complete, touch POWER/CANCEL once to cancel the cycle. Then touch POWER/CANCEL again to start the cycle. If error appears again, call for service.
		Both hoses must be attached and have water flowing to the inlet valve.
		Both hot and cold water faucets must be open.
		Inlet valve screens on washer may be clogged.
		Remove any kinks in the inlet hose.
If used, auto shut off connectors and hoses must be properly installed and in working order.		
F09 followed by E01 (drain pump system error) appears in display	Check plumbing for correct drain hose installation. Drain hose extends into standpipe farther than 4V2" (114 mm).	Check drain hose for proper installation.
		Make sure the drain hose is not kinked, bent, or twisted.
Remove any clogs from drain hose.		
Use drain hose form and securely attach to standpipe.		
Lower drain hose if the end is higher than the floor.		
Use only HE detergent. Always measure detergent according to manufacturer's directions based on load size.		
F05 followed by E02 (door will not lock) appears in display	Washer door not locking.	Touch POWER/CANCEL to cancel the cycle. Make sure the door is closed completely and latching. Check for items in the washer drum that may be keeping the door from locking completely.

If you experience	Possible Causes	Solution
"rL" (remove load) appears in display	Load detected in drum during Clean Washer with affresh® cycle.	Remove items from washer drum and rerun Clean Washer with affresh® cycle.
Washer making error beeps	Door has not been opened and closed for at least 3 cycles.	This code may appear when the washer door has not been opened and closed. Open and close the door to clear the display.
Washer beeps when START is touched	Door not closed.	Close the door completely.
F## E## code other than as described above appears in display	System error code.	Touch POWER/CANCEL once to clear the error code. Touch POWER/CANCEL again to restart wash cycle. If the error code appears again, call for service.
"Int" (interrupted) appears in display	The cycle was paused or cancelled.	The washer can take 20 to 30 minutes to drain and will display this error code during the drain cycle. Touch POWER/CANCEL once to clear the code. Touch POWER/CANCEL again to restart wash cycle.
Clean Washer LED flashing at end of wash cycle	The washer has run 30 wash cycles and is indicating a reminder to run the Clean Washer with affresh® cycle.	Run the Clean Washer with affresh® cycle. The Clean Washer with affresh® cycle is not turned on. The Clean Washer LED will flash at the end of a wash cycle after 30 regular wash cycles. After 30 more wash cycles are completed, the Clean Washer LED will flash at the end of a wash cycle as a reminder.
Vibration or Off-Balance		
Vibration, rocking, or "walking"	Feet may not be in contact with the floor and locked.	Front and rear feet must be in firm contact with the floor. The washer must be level to operate properly. Tighten the feet against the bottom of the cabinet.
	Washer may not be level.	Check floor for flexing or sagging. If floor is uneven, place a 1/2" (19 mm) piece of plywood under your washer. See "Level the Washer" in Installation Instructions.
	Load could be unbalanced or too large.	Avoid tightly packing the load. Avoid washing heavy items. Balance a single item such as a rug or jacket with extra items.

If you experience	Possible Causes	Solution
		Item or load not suitable for selected cycle and “Using Your Washer.”
	The shipping bolts are still in the back of the washer.	See “Remove transport bolts from washer” in the Instructions.
Noises		
Clicking or metallic noises	Door locking or unlocking.	The door will lock, unlock, and lock again. It clicks after touching and holding START/PAUSE.
	Objects caught in washer drain system.	Empty pockets before washing. Loose items could fall between washer drum and tub. If necessary, you may be necessary to call for service to inspect the drain system. It is normal to hear metal items on clothes, such as snaps, buckles, or zippers touch against the drum.
Gurgling or humming	Washer may be draining water.	The pump may make a humming sound or surging as final amounts of water are being spun/ drain cycles. This is normal at certain stages of the cycle.
Rolling or sloshing and occasional clicking (on low-speed spin)	Steel balls in the balancing system are balancing the load.	This is normal at certain stages of the cycle.
Water Leaks		
Check the following for proper installation	Fill hoses not attached tightly.	Tighten fill-hose connection.
	Fill hose washers.	Properly seat all four fill-hose flat washers.
	Drain hose connection.	Check that the drain hose is properly seated in the laundry tub.
	Check household plumbing for leaks or clogged sink or drain.	Water can back up out of a clogged sink or drain. Check all household plumbing for leaks (laundry water pipes, and faucets.)
	Not using HE detergent or using too much HE detergent.	Only use HE detergent. Suds from regular detergent can cause leaking from the door or rear of cabinet.



If you experience	Possible Causes	Solution
Water or suds leaking from door or rear of cabinet		measure detergent and follow manufacturer's instructions based on your load requirements.
	Residue on door glass.	Periodically clean the underside of the door glass to prevent potential leaks.
	Door opened during "Add a Garment."	Water can drip off the inside of the door when the door is opened after the start of a cycle.
Washer not performing as expected		
Load not completely covered in water	Water level not visible on door or does not cover clothes.	This is normal for an HE front load washer. The washer senses load sizes and adds the correct amount of water for optimal cleaning.
Washer won't run or fill, washer stops working	Check for proper water supply.	Both hoses must be attached and have the correct water pressure at the inlet valve.
		Both hot and cold water faucets must be open.
		Check that inlet valve screens have not become clogged.
		Check for any kinks in inlet hoses, which can restrict water flow.

WARNING: Electrical Shock Hazard

- Plug into a grounded 3 prong outlet
- Do not remove ground prong
- Do not use an adapter
- Do not use an extension cord
- Failure to follow these instructions can result in death, fire, or electrical shock.



Washer won't run or fill, washer stops working (cont.)	Check proper electrical supply.	Plug power cord into a grounded 3-prong outlet.
		Do not use an extension cord.
		Ensure there is power to outlet.
		Check electrical source or call an electrician if the voltage is low.
		Reset a tripped circuit breaker. Replace a blown fuse. NOTE: If problems continue, contact an electrician.
Normal washer operation.		Door must be completely closed and latched for washer to run.
		Washer will pause during certain phases to allow water to drain and interrupt cycle.
		The washer pauses for about 2 minutes during certain phases. Allow the cycle to continue. Some cycles include tumbling and soak.
		Washer may be stopped to reduce suds during certain phases.
		Cold Wash uses less water in the beginning to provide a high concentration of detergent for better cleaning action. Following this concentrated tumbling phase, more water is used to complete the wash.
		Steam Models only: During the first 20 minutes of the Wash cycle, the Washer with affresh® cycle, it will activate the steam phase. The drum will not spin or fill with water. You may see condensation on the door glass during this initial phase. If you use an affresh® Washer Cleaner tablet, it will melt during the steam phase. This is normal.
The washer door is not firmly shut.	The door must be closed during operation.	
Washer not loaded as recommended.		Remove several items, rearrange load evenly, and close door. Close door and touch and hold START.
		Do not add more than 1 or 2 additional items after the cycle has started to avoid tightly packing or unbalancing the load.



		Do not add more water to the washer.
	Not using HE detergent or using too much HE detergent.	Only use HE detergent. Suds from regular slow or stop the washer. Always measure detergent according to manufacturer's directions based on your load size. To remove suds, cancel cycle. Select DRAIN & SPIN. Touch and hold START. Do not add more detergent.
	Door not opened between cycles.	After 3 wash cycles in a row are completed, the door will not be opened and then closed before a new cycle begins.
Washer not draining/ spinning, loads are still wet	Drain hose extends into standpipe farther than 4.5" (114 mm).	Check drain hose for proper installation and securely attach to drainpipe or tub opening.
	The drain hose is clogged, or the end of the drain hose more than 96" (2.4 m) above the floor.	Lower drain hose if the end is higher than the floor. Remove any clogs from drain hose. See "Drainage Requirements" in Installation Instructions.
	The drain hose fits too tightly in the standpipe, or is it taped to the standpipe.	The drain hose should be loose yet fit snugly in the standpipe. Do not tape the drain hose with tape. The hose needs to be secured to the standpipe. See "Secure the Drain Hose" in Installation Instructions.
	Using cycles with a lower spin speed.	Cycles with lower spin speeds remove less water than cycles with high spin speeds. Use the recommended spin speed for your garment.
	Washer not loaded as recommended.	A tightly packed or unbalanced load may prevent the washer from spinning correctly, leaving the load wetter than normal. See "Cycle Guide" for load size recommendations.
	The load may be out of balance.	Avoid washing single items. Balance a sweater or rug or jeans jacket with a few extra items.
	Not using HE detergent or using too much HE detergent.	Use only HE detergent. Suds from regular detergent can slow or stop draining. Always measure and follow manufacturer's directions for detergent load. To remove extra suds, select DRAIN & SPIN. Do not add detergent.



	Small items may have been caught in the pump or stuck between the washer drum and the outer tub.	Check the drum for any items sticking to it. Empty pockets and use garment bags for items.
	There are too many clothes in the Wash & Dry cycle.	Only use the Overnight Wash & Dry cycle for synthetic garments, athletic uniforms, or
Door locked at end of wash cycle.	Water remaining in washer after cycle.	Select DRAIN & SPIN to remove any water from the washer. The washer door will unlock at the end of the cycle.
	Fresh Hold®/Fresh Spin™ option is on.	While this option is on, the fan blows (Fresh Spin™ only) and the load is tumbled periodically (Fresh Hold® option) or 6 hours (Fresh Spin™ option). The door remains locked during this time. To cancel the option by touching POWER/PAUSE.
Door will not unlock	Door locks when cycle has started.	If the “Add a Garment” light is lit, touch the button. The door will unlock.
Incorrect or wrong wash or rinse temperatures	Check for proper water supply.	Make sure hot and cold inlet hoses are attached to the correct valves.
		Both hoses must be attached to both water valves and have both hot and cold water flowing to the washer.
		Check that inlet valve screens are not clogged.
	Remove any kinks in hoses.	
	Washing many loads.	Your hot water tank may not have enough hot water to keep up with the number of hot or warm wash cycles.
Desired setting or option does not light	For best performance, not all settings are available with each cycle, and some options cannot be used together.	See the “Cycle Guide” for the available settings and options for each cycle.
Load not rinsed	Check for proper water supply.	Make sure hot and cold inlet hoses are attached to the correct valves.
		Both hoses must be attached and have both hot and cold water flowing to the inlet valve.
		Both hot and cold water faucets must be open.
		Inlet valve screens on washer may be clogged.



		Remove any kinks in the inlet hose.
	Not using HE detergent or using too much HE detergent.	<p>The suds from regular detergent can cause the washer to operate incorrectly.</p> <p>Use only HE detergent. Always measure detergent according to manufacturer's directions based on load size.</p>
	Washer not loaded as recommended.	<p>Avoid tightly packing the washer. The washer will operate better if loaded well if tightly packed. Load with dry items. See the "Load Size Guide" for load size recommendations for each cycle.</p> <p>Use cycle designed for the fabrics being washed.</p> <p>Add only 1 or 2 garments after washer has started.</p>
	The load may be out of balance.	When load unbalance occurs, a washing cycle will be interrupted to redistribute the load. This may lengthen the cycle. Avoid washing single items. Balance a single item with other items. For example, balance a pair of jeans jacket with a few extra items.
Load is wrinkled, twisted, or tangled	Washer not loaded as recommended.	<p>Add load loosely. Items need to move freely during the cycle to reduce wrinkling and tangling. See the "Cycle Guide" for load size recommendations for each cycle.</p> <p>Reduce tangling by mixing types of loads. Use the recommended cycle for the type of garment.</p>
	Wash action too long for load.	Select a lower soil level. Note that items may not be cleaned as deeply as when using a higher soil level.
	Spin speed too high for load.	Select a lower spin speed. Note that items may be damaged when using a higher speed spin.
	The washer is not unloaded promptly.	Unload the washer as soon as it stops. Use the Fresh Spin™ option if you will not be able to unload the washer at the end of the cycle.
	Not choosing the right cycle for the load being washed.	Use the Delicates cycle or another cycle with a lower spin speed to reduce wrinkling.
	The wash water was not warm enough to relax wrinkles.	If safe for load, use warm or hot wash water to help relax wrinkles.



Not cleaning or removing stains	Washer not loaded as recommended.	Add load loosely. Items need to move freely. See the “Cycle Guide” for load size recommendations for each cycle. Add only 1 or 2 garments after washer has started.
	Not using HE detergent or using too much HE detergent.	Use only HE detergent. Always measure detergent according to manufacturer's directions based on load size.
	Hard water or high level of iron (rust) in water.	You may need to install a water softener.
	Fabric softener dispensing ball used.	Dispensing balls will not operate correctly. Add liquid fabric softener to the fabric softener compartment.
	Powdered detergent used for low-speed cycle.	Consider using liquid detergent.
	Not using correct cycle for fabric type.	Use a higher soil level setting and warmer water temperature to improve cleaning.
		If using Rapid Wash cycle, wash only a few items.
		Use Power Wash cycle for tough cleaning. Add an extra rinse for heavily soiled loads.
	Not using dispensers.	Use dispensers to avoid chlorine bleach staining.
		Load dispensers before starting a cycle.
Avoid overfilling.		
Do not add products other than those specified for the load.		
Not washing like colors together.	Wash like colors together and remove promptly. Make sure rinse cycle is complete to avoid dye transfer.	
Not enough detergent used, or hard water.	Use more detergent for washing heavy soiled items or hard water.	
Odors	Monthly maintenance not done as recommended.	Run the Clean Washer with affresh® cycle every 30 wash cycles. See “Washer Care” in “Maintenance.”



		Unload washer as soon as cycle is complete. Use the Hold®/Fresh Spin™ option if load cannot be removed immediately after the wash is complete.
	Not using HE detergent or using too much HE detergent.	Use only HE detergent. Be sure to measure detergent correctly and follow the manufacturer's directions. See "Washer Care" section.
	Door not left open after use.	This washer has a tight seal to avoid water leaks and odors, leave the door open to allow the seal to dry between uses.
Fabric Damage	Sharp items were in pockets during wash cycle.	Empty pockets, zip zippers, and snap on buttons before washing to avoid snags and tears.
	Strings and straps could have tangled.	Tie all strings and straps before starting wash cycle.
	Items may have been damaged before washing.	Mend rips and broken threads in seams before washing.
	Fabric damage can occur if washer is tightly packed.	Avoid tightly packing the washer. Load washer with clothes loosely. Use cycle designed for the fabrics being washed.
		Add only 1 or 2 garments after washer is started.
	Liquid chlorine bleach may have been added incorrectly.	Do not pour liquid chlorine bleach directly into the washer. Wipe up any bleach spills.
		Undiluted bleach will damage fabrics. Do not use bleach if not recommended by manufacturer.
Gray whites, dingy colors	Load not sorted properly.	The transfer of dye can occur when mixing colors in a load. Sort dark clothes from whites.
	Wash temperatures too low.	Use hot or warm temperatures if safe for fabrics. Make sure your hot water system is adequate to provide the temperature for wash.
	Not enough detergent used, or hard water.	Use more detergent for washing heavy loads or in hard water.



Incorrect dispenser operation	Clogged dispensers or laundry products dispensing too soon.	Do not overfill dispenser. Overfilling causes overflowing and prevents proper dispensing.
		Load dispensers before starting a cycle.
		Homes with low water pressure may result in incomplete dispensing in the dispenser. To avoid, select a warmer water temperature if possible, depending on your load.
	Liquid chlorine bleach not used in bleach compartment.	Use only liquid chlorine bleach in the bleach compartment.
	Water in dispenser after cycle has finished.	It is normal for small amounts of water to remain in the dispenser at the end of the cycle.
Single-dose laundry packet not dissolving	Adding laundry packet incorrectly.	Be sure laundry packet is added to washer before clothes. Do not add packet to dispenser after clothes. Follow manufacturer's instructions to avoid damage to garments.
Cycle time changes or cycle time too long	Normal washer operation.	The cycle times vary automatically based on load size, water pressure, water temperature, detergent amount, and the options you select will also affect the cycle time.
	Excessive suds in washer.	When excessive suds are detected, a sensor will automatically start to remove extra suds by pausing the cycle and rinsing of your garments. This routine will extend the cycle beyond the original cycle.
	Load may be out of balance.	When load unbalance occurs, a washing machine sensor will redistribute the load. This may lengthen the cycle when washing single items. Balance a single item, such as a jeans jacket with a few extra items.
	Not using correct cycle for load type.	The Rapid Wash cycle is designed for small loads (such as 1-2 items) of lightly soiled garments. If large items are used in this cycle, cycle time will be increased. When using the Rapid Wash or Delicate cycle, always use a small load. This ensures a gentle wash for delicate garments without increasing cycle times.



The controls are not responding	Control Lock is on.	Touch and hold CONTROL LOCK for 3 seconds. For each second CONTROL LOCK is held down, the display will count down one second: "3," then "2," then "1"
---------------------------------	---------------------	---

Warning

This content is compiled from multiple sources and is provided for reference purposes only. It may not be complete or fully applicable to all situations. If you are unable to resolve your issue, please contact the product manufacturer or an authorized service provider for official support.

