

Connecting the TV to the One Connect

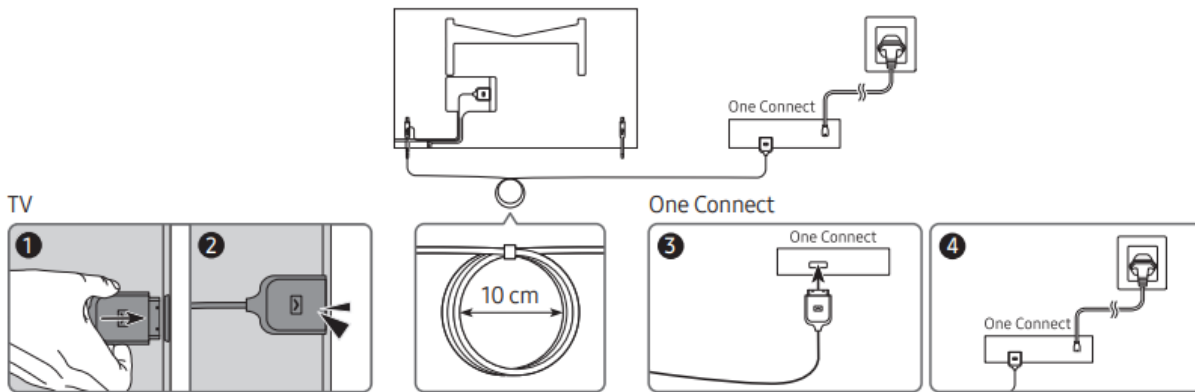

To connect the One Connect Cable to the One Connect and your TV, follow these steps:

1. After the TV is completely set up and placed in its final position, connect the One Connect Cable to the One Connect and the TV as shown in Steps 1 to 3 above.
WARNING: Make sure that both connectors are fully and firmly connected. If either connector is not connected properly, there is a danger of severe electric shock.
2. Connect the One Connect AC power cord to the One Connect, and then connect the cord to a wall outlet as shown in Step 4 above.
WARNING: Follow the directions exactly. Be sure to connect the power cord to the wall outlet as the last step. Always disconnect the power cord from the wall outlet before disconnecting the One Connect Cable from the back of the TV or from the One Connect.
– See the illustrated Quick Setup Guide for more information.
3. Connect your peripherals (cable box, Blu-ray player, etc.) to the One Connect.

WARNING:

- Do not use the One Connect in the upside-down or upright position.
- When connecting the One Connect Cable, pay attention to the shapes and sizes of its connectors so that they are connected correctly. Failure to do so may cause product malfunction.
- When connecting the One Connect Cable, be careful not to twist the cable of the One Connect Cable. Failure to do so may cause performance degradation of the TV or damage to the cable.
- When arranging the remaining cable, refer to the figure on the previous section for the correct arrangement.
- Take care not to subject the cable to any of the actions below. The One Connect Cable contains a power circuit. You could damage the cable and subject yourself to an electric shock.
- Handle the One Connect carefully. It is heavy.



Bending



Twisting



Pulling



Pressing on



Electric shock

TV Installation



Mounting the TV on a wall

WARNING: If you mount this TV on a wall, follow the instructions exactly as set out by the manufacturer. Unless it is correctly mounted, the TV may slide or fall and cause serious injury to a child or adult and serious damage to the TV.

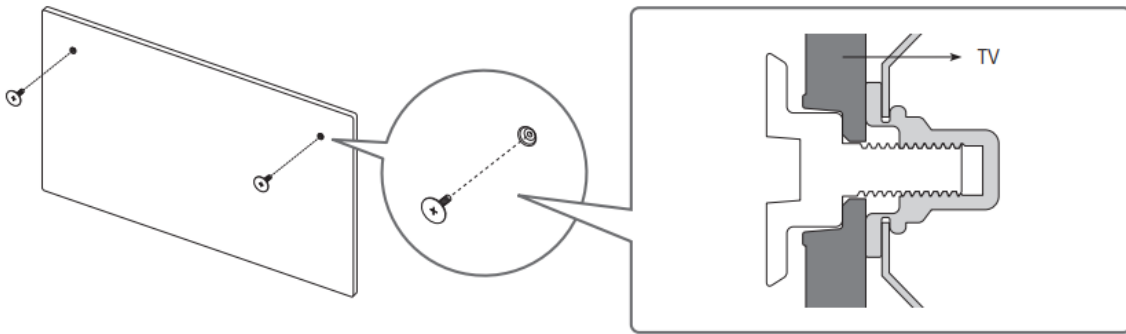
- Refer to the installation manual included with the Samsung wall mount kit.

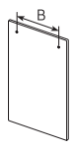

- Samsung Electronics is not responsible for any damage to the product or injury to yourself or others if you choose to install the wall mount on your own.
- You can install your wall mount on a solid wall perpendicular to the floor. Before attaching the wall mount to surfaces other than plaster board, contact your nearest dealer for additional information. If you install the TV on a ceiling or slanted wall, it may fall and result in severe personal injury.

Type	TV size in inches	Screw hole specs in millimetres	Screw	Quantity
	32	582.2	 M4	2
		277.5		

WARNING: Do not install your wall mount kit while your TV is turned on. This may result in personal injury from electric shock.

- Be sure to use only the screws provided with the product. (Otherwise, it may cause damage to the TV or the wall-mounted TV may fall from the wall.)
- Do not fasten the screws too firmly. This may damage the product or cause the product to fall, leading to personal injury. Samsung is not liable for these kinds of accidents.
- Samsung is not liable for product damage or personal injury when a non-specified wall mount is used or when the consumer fails to follow the product installation instructions.

Providing proper ventilation for your TV

When you install your TV and One Connect, maintain a distance of at least 10 cm between the TV and One Connect with other objects (walls, cabinet sides, etc.) to ensure proper ventilation. Failing to maintain proper ventilation may result in a fire or a problem with the product caused by an increase in its internal temperature.

- When you install your TV with a stand or a wall mount, we strongly recommend you use parts provided by Samsung Electronics only. Using parts provided by another manufacturer may cause difficulties with the product or result in injury caused by the product falling.

Safety Precaution: Securing the TV to the wall to prevent falling

CAUTION: Pulling, pushing, or climbing on the TV may cause the TV to fall. In particular, ensure your children do not hang on or destabilise the TV. This action may cause the TV to tip over, causing serious injuries or death. Follow all safety precautions provided in the Safety Flyer included with your TV.



WARNING: Never place a television set in an unstable location. The television set may fall, causing serious personal injury or death. Many injuries, particularly to children, can be avoided by taking simple precautions such as:

- Always use cabinets or stands or mounting methods recommended by the manufacturer of the television set.
- Always use furniture that can safely support the television set.
- Always ensure the television set is not overhanging the edge of the supporting furniture.

- Always educate children about the dangers of climbing on furniture to reach the television set or its controls.
- Always route cords and cables connected to your television so they cannot be tripped over, pulled or grabbed.
- Never place a television set in an unstable location.
- Never place the television set on tall furniture (for example, cupboards or bookcases) without anchoring both the furniture and the television set to a suitable support.
- Never place the television set on cloth or other materials that may be located between the television set and supporting furniture.
- Never place items that might tempt children to climb, such as toys and remote controls, on the top of the television or furniture on which the television is placed.

If the existing television set is going to be retained and relocated, the same considerations as above should be applied.

- When installed on a stand, the display of this product is tilted slightly backward and its angle cannot be adjusted.
- If any object is placed on the stand or the floor is tilted, the product may fall over, which causes malfunction or personal injury

Preventing the TV from falling

1. Using the appropriate screws, firmly fasten a set of brackets to the wall. Confirm that the screws are firmly attached to the wall.
 - You may need additional material such as wall anchors depending on the type of wall.
2. Using the appropriately sized screws, firmly fasten a set of brackets to the TV.
 - For the screw specifications, refer to the Screw part in the table under "Mounting the TV on a wall".
3. Connect the brackets fixed to the TV and the brackets fixed to the wall with a durable, heavy-duty string, and then tie the string tightly.
 - Install the TV near the wall so that it does not fall backwards.
 - Connect the string so that the brackets fixed to the wall are at the same height as or lower than the brackets fixed to the TV.

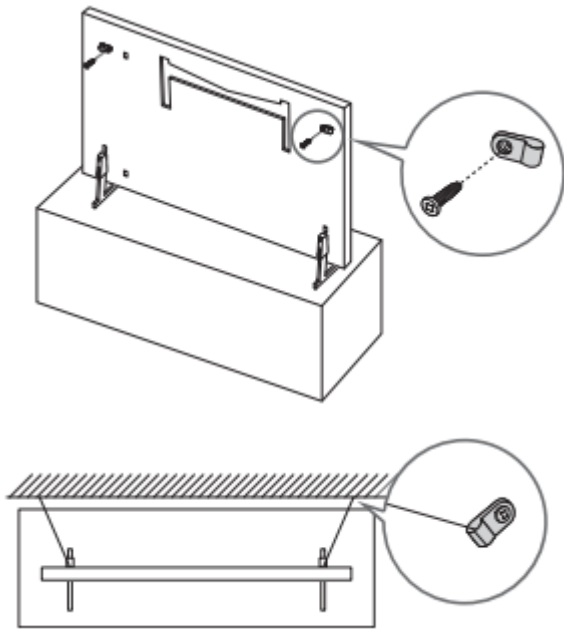

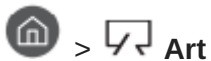

- The product colour and shape may vary depending on the model.

Using Art Mode



You can use **Art** mode function to display image content such as artworks or photos when you are not watching TV in full screen mode.

- Press the  button on the remote control to switch to TV mode or **Art** mode.
- Press the  button in **Art** mode to switch to TV mode.
- To turn off the TV completely, press and hold the  button on the remote control, or press the TV Controller button at the top left of the TV.
 - If you use a remote control other than the Samsung Smart Remote, the TV may not be turned off completely.
- In **Art** mode, the brightness and colour tone of your TV are automatically adjusted depending on the ambient, and the TV can be automatically turned off.
 - The TV is set by default so that the screen turns off automatically when the ambient light dims in **Art** mode.
- In **Art** mode, you can connect your mobile device to the TV using the SmartThings app on the mobile device to view photos on the mobile device.
 - This function may not be supported depending on the TV model or mobile device.
 - Supported features may differ depending on the version of the SmartThings app.

Viewing images

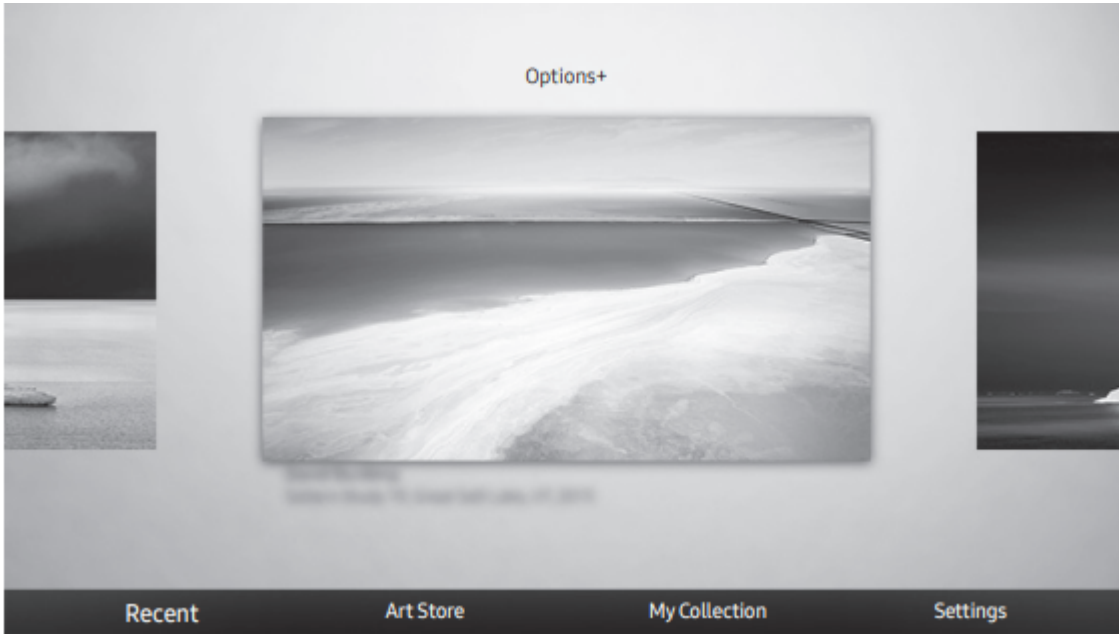

- The image on your TV may differ from the image above depending on the model and geographical area.

To view an image in Art mode, select one of the menus below. To switch to the sub menu where you can select images, press the Select button, one of the four directional buttons, or  button in Art mode. Then, use the directional buttons on the remote control to move to desired image, and then press the Select button. Set appears at the top of the selected image, and you can view the selected image in Art mode.

- Recent
You can manipulate the last selected images.
- Art Store
You can go to Art Store to purchase various images.
 - The Art Store may not appear depending on the network connection status.
- My Collection
You can view a list of artworks and photos that you set as  Favourite in Favourites. You can also select the desired ones among the images saved on an external storage device or a mobile device and save them in My Photos.
 - In order to fetch the images from your mobile device, the SmartThings app must have been installed in your mobile device.

Viewing images by time

1. Use the directional buttons on the remote control to move to My Collection.

2. Use the directional buttons to move to Favourites or My Photos.
To view the images on the mobile device connected via the USB or SmartThings app, select the desired images on the connected device and then save them into My Photos.
3. Use the directional buttons on the remote control to move to Options+ at the top of the screen.
4. Press the Select button when the Start Slideshow item appears.
5. Use the directional buttons on the remote control to select the time that images will be replaced, and then press the Select button.

Import images from an external storage device

1. Connect an external storage device that contains images to the TV.
2. Use the directional buttons on the remote control to move to My Collection, and then move to the connected external storage device.
3. Use the directional buttons on the remote control to move to Save to My Photos at the top of the screen, and then press the Select button.
4. Use the directional buttons on the remote control to move to an image, and then press the Select button.
 - You can select multiple images.
5. Use the directional buttons on the remote control to move to Save Selected at the top of the screen, and then press the Select button.
6. The selected image or images are saved in My Photos.
 - Recommended resolutions: 1920 x 1080 (16:9)

Buying images from Art Store

1. Use the directional buttons on the remote control to move to Art Store.
2. Use the directional buttons on the remote control to move to a topic, and press the Select button. You can select any subtopics or images on the screen.
 - The entry path may differ by each topic.
3. Use the directional buttons on the remote control to move to an image, and press the Select button.
4. Use the directional buttons on the remote control to move to Options+ at the top of the screen, and then select Get Trial Membership or Buy to buy the selected image.
 - Displays Get Trial Membership if you have not joined Art Store Membership.
5. Use the directional buttons on the remote control to select payment methods, and then press the Select button.
6. Follow the on-screen instructions to procedure payment.

Subscribing to Art Store Membership

When you subscribe to Art Store Membership, you can use Art Store unlimitedly and enjoy various art works by replacing them with new ones according to your preferences.

1. Use the directional buttons on the remote control to move to Art Store.
2. Use the directional buttons on the remote control to move to Membership.
3. Follow the on-screen instructions to enter your membership information

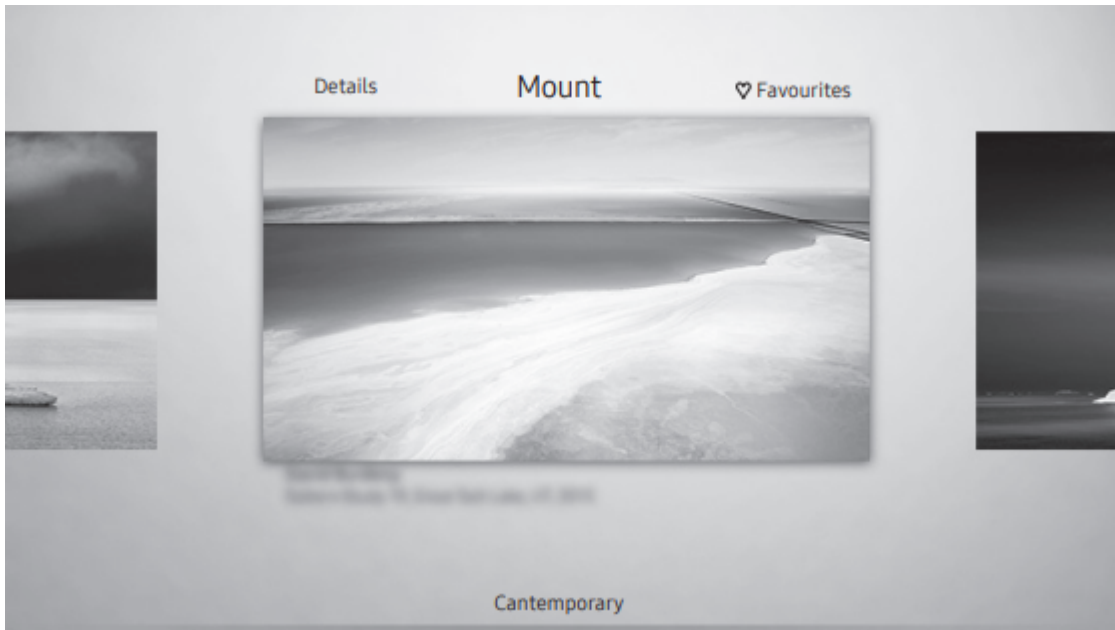

Setting the style of the selected image



- The image on your TV may differ from the image above depending on the model and geographical area.

Use the directional buttons on the remote control to move to Options+ at the top of the screen. You can use the following menus:

- Details
You can find more information about the image.
- Photo Filter
You can apply the selected filter's effect to the image according to your preferences.
– This function is only available for saved images on My Photos.
- Mount
You can apply various border styles and colours to the image according to your preferences.
– This function is only available for saved images on My Photos.
- Favourite
You can set (or not set) an image that you prefer as a favourite item by pressing the Select button on the remote control. You can view a list of items set as your favourites in My Collection > Favourites.

-  Favourite: Not set as a favourite.
-  Favourite: Set as a favourite.

Apply a border style and a colour to an image

1. Using the directional buttons on the remote control to move to the image whose border style and colour you want to change, move to Options+ at the top of the screen, and then select Mount.
2. Use the directional buttons on the remote control to select the border style and colour that you want.
3. Change the border style and colour, and then press the Select button to move the focus to the image.
 - If you want to change only either the border style or the color, change it, and then press the Select button to save the changes.
4. To save the selected border style and colour, press the Select button again.
 - If you press the  button to exit, the border style and colour you changed are not saved.

Setting up Art mode

In Art mode, use the directional buttons on the remote control to move to the Settings menu item at the bottom. You can adjust the following functions:

- Brightness

Use the directional buttons on the remote control to move to Modify at the top, and then press the Select button. In the next screen, adjust the picture brightness. After selecting the desired settings, press the Select button on the remote control.

 - To immediately set Brightness while enjoying Art mode, press the  button on the remote control.
- Sleep After

If no motion is detected around the TV for the set time, the TV turns off automatically. Use the directional buttons on the remote control to move to the top items. After selecting the desired time, press the Select button on the remote control.
- Night Mode

When this function is turned on, the TV turns off automatically if no light is detected around the TV. Use the directional buttons on the remote control to move to the top items, and then turn this function on or off.

Remove images from My Collection

You can remove the saved images from My Collection.

1. Use the directional buttons on the remote control to move to My Collection.
2. Use the directional buttons on the remote control to move to Favourites or My Photos.
3. Use the directional buttons on the remote control to move to Options+ at the top of the screen.
4. Move the focus to Remove, and then press the Select button on the remote control.
5. Use the directional buttons on the remote control to move to an image, and then press the Select button.
 - You can select multiple images.
6. Use the directional buttons on the remote control to move to Remove Selected at the top of the screen, and then press the Select button.

Using Art mode with the SmartThings app

Once you have installed the SmartThings app on your mobile device, you can use the following functions:

You can download the SmartThings app from Google Play Store, Samsung Apps, or the App Store.

– The features or terminology may vary depending on the version of the SmartThings app.

– On tablet devices, Art mode features may not be supported by the SmartThings app.

- Selecting images
- Subscribing to Art Store Membership
- Creating Collage: Combine multiple images into one image.
- Applying border styles and colours to images
- Setting the brightness for Art mode
- Setting Sleep After: When no motion is detected for the time specified in Art mode, the TV turns off automatically.
- Setting Night Mode: Set The Frame to turn off automatically if no light is detected in the room.

The Samsung Smart Remote

About the Buttons on the Samsung Smart Remote

The images, buttons, and functions of the Samsung Smart Remote may differ depending on the model.

(Power)

When watching TV, press to switch to **Art mode**. In **Art mode**, press to switch to watching TV.

- Press and hold to turn off the TV completely.

(Bixby)

Runs Bixby. Press and hold the button, say a command, and then release the button to run Bixby.

When you press the button, the **Explore Now** menu appears at the bottom of the screen.

- The supported Bixby's languages and features may differ by geographical region.

123 (Number button)

When pressed, a number strip appears on the bottom of the screen. Select numbers and then select **Done** to enter a numeric value. Use to change the channel, enter a PIN, enter a ZIP code, etc.

- When you press the button and then select **TTX/MIX** from the pop-up list, the **TTX** menu appears.

(Colour button)

Use these coloured buttons to access additional options specific to the feature you are using.

- To immediately set **Brightness** while enjoying **Art mode**, press the button.

Select

Selects or runs a focused item. When pressed while you are watching a broadcast programme, detailed programme information appears.

Directional button (up/down/left/right)

Moves the focus and changes the values seen on the TV's menu.

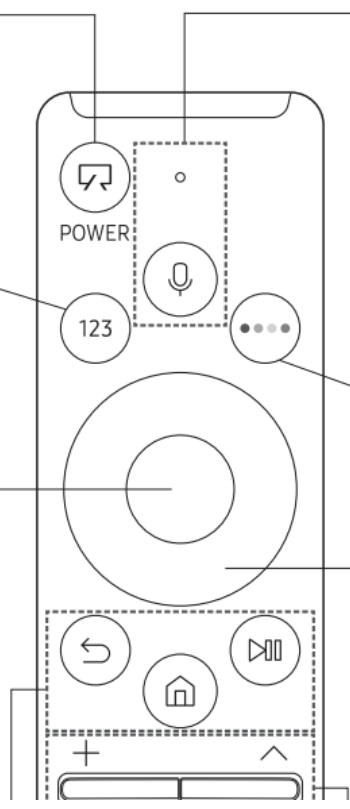

(Return)

Returns to the previous menu. When pressed for 1 second or more, the running function is terminated. When pressed while you are watching a programme, the previous channel appears.

(Play/pause)

When pressed, the playback controls appear. Using these controls, you can control the media content that is playing.

(Smart Hub)

Returns to the Home Screen.

- Press in **Art mode** to switch to TV mode.

+ / - (Volume)

Move the button up or down to adjust the volume. To mute the sound, press the button. When pressed for 1 second or more, the **Accessibility Shortcuts** menu appears.

^ / ∨ (Channel)

Move the button up or down to change the channel. To see the **Guide** or **Channel List** screen, press the button. (The **Guide** or **Channel List** screen appears depending on the geographical area.)

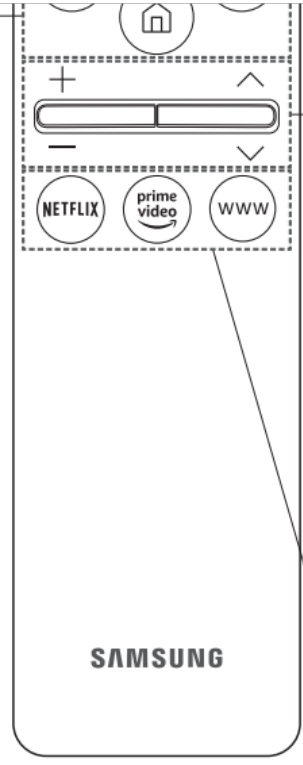



Press each button to run its function. (These buttons may vary depending on the geographical area.)

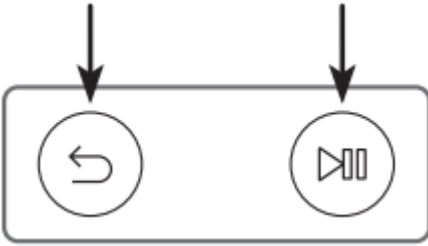

Pairing the TV to the Samsung Smart Remote



When you turn on the TV for the first time, the Samsung Smart Remote pairs to the TV automatically. If the Samsung Smart Remote does not pair to the TV automatically, point it at the remote control sensor of the TV, and then press and hold the buttons labelled  and  as shown in the figure on the left simultaneously for 3 seconds or more.

Installing batteries into the Samsung Smart Remote

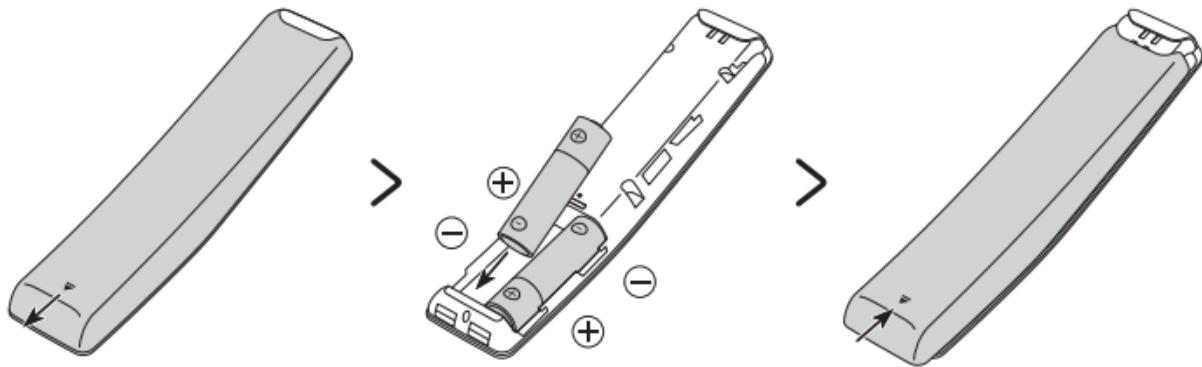

To install the batteries (1.5V AA type), push the rear cover open in the direction of the arrow at the bottom of the illustration, and then insert the batteries as shown in the figure. Make sure that the positive and negative ends are facing in the correct direction. Close the rear cover as shown.



- Alkaline batteries are recommended for longer battery life.

Running the Initial Setup

When you turn on your TV for the first time, it immediately starts the Initial Setup. The Initial Setup allows you to configure the basic settings for the TV to operate, such as broadcast reception, channel search, and network connection, at one time.

- Before starting the Initial Setup, be sure to connect external devices first.
- To use the TV's smart features, the TV must be connected to the Internet.
- To perform Initial Setup using the SmartThings app, you must connect your mobile device via Wi-Fi.

- If the pop-up for setup does not appear automatically in the SmartThings app on your mobile device, continue setup manually after adding the TV using Add Device on the dashboard of the SmartThings app.
- The SmartThings app is available for mobile devices running Android 6.0 or higher or iOS 10 or higher.
- Noise may occur temporarily when the TV communicates with mobile devices.
- TV setup has been optimised for Landscape mode.

You can also start the Initial Setup using the TV's menu ( >  Settings > General > Reset).

Follow the instructions displayed on the Initial Setup screen and configure the TV's basic settings to suit your viewing environment.

Using the TV Controller

You can turn on the TV with the TV Controller button at the top left of the TV, and then use the Control menu. The Control menu appears when the TV Controller button is pressed while the TV is On. For more information about its usage, refer to the figure below.

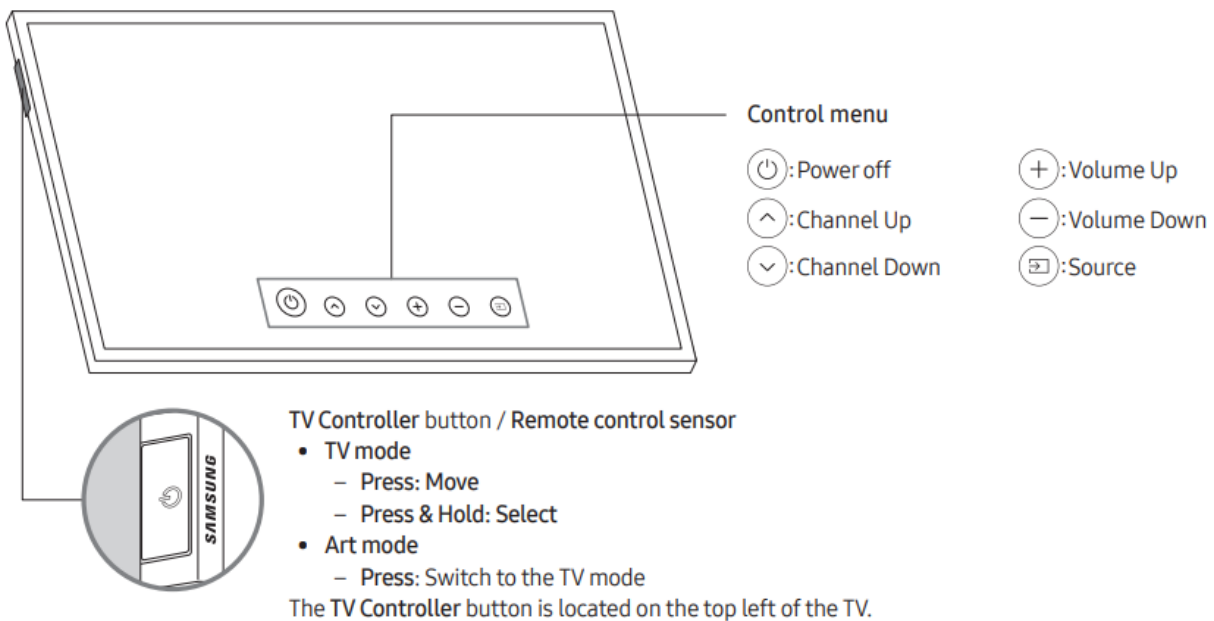

- In Art mode, the power indicator at the top left of the TV remains off

Connecting to a Network

Connecting the TV to a network gives you access to online services, such as Smart Hub, as well as software updates.

Network Connection - Wireless

Connect the TV to the Internet using a wireless access point or modem

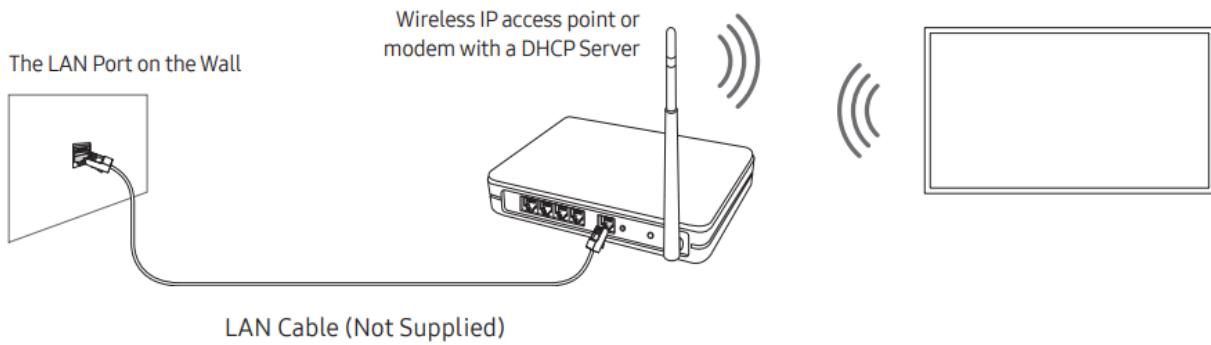

Mobile Network

Depending on the model or geographical area.

While connecting to the mobile network, some functions might be unavailable.

Refer to the following diagram and insert the Mobile Dongle into the USB port. The Mobile Dongle must be connected to the TV in order to connect to the mobile network. However, the Mobile Dongle is sold separately and is not available from Samsung.

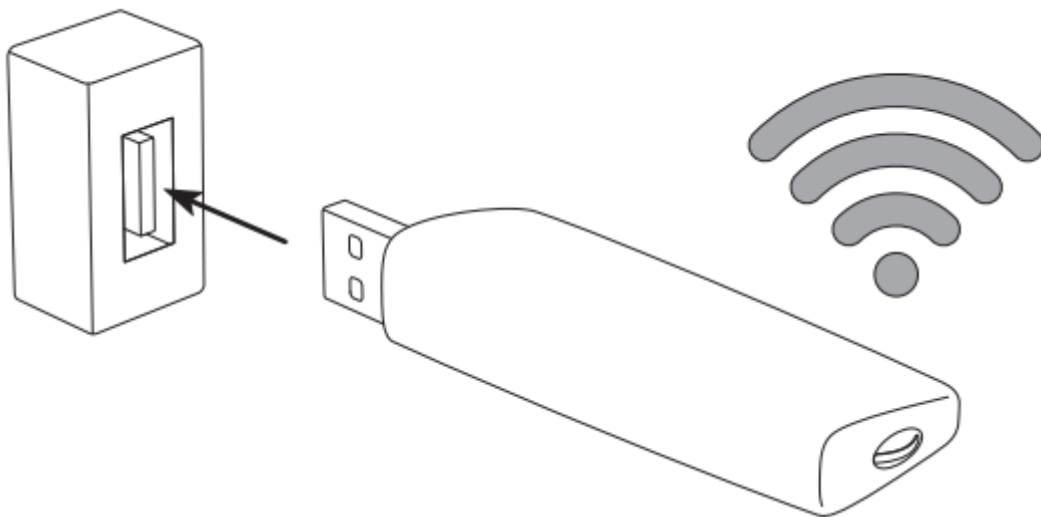

If you have any problems using online services, please contact your Internet service provider.

- When you use a large mobile dongle(Data Card), USB devices may not work properly due to interferences among the USB ports, or the wireless network may not work properly due to interferences from the peripherals and surroundings. In this case, use a USB extension cable to connect a large mobile dongle to a USB port.



Troubleshooting and Maintenance







Troubleshooting

- This TFT LED panel is made up of sub pixels which require sophisticated technology to produce. There may be, however, a few bright or dark pixels on the screen. These pixels will have no impact on the performance of the product.
- To keep your TV in optimum condition, upgrade to the latest software. Use the Update Now or Auto update functions on the TV's menu ( >  Settings > Support > Software Update > Update Now or Auto update).
- In Portrait Mode, some apps or external inputs may not support the full screen.

The TV won't turn on

- Make sure that the AC power cord is securely plugged in to the One Connect and the wall outlet.
- Make sure that the wall outlet is working and the remote control sensor at the top left of the TV is lit and glowing a solid red.
- Try pressing the TV Controller button at the top left of the TV to make sure that the problem is not with the remote control. If the TV turns on, refer to "The remote control does not work".

There is no picture/video/sound, or a distorted picture/video/sound from an external device, or "Weak or No Signal" is displayed on the TV, or you cannot find a channel.

- Make sure the connection to the device is correct and that all cables are fully inserted.
- Remove and reconnect all cables connected to the TV and the external devices. Try new cables if possible.
- Confirm that the correct input source has been selected ( >  Source).
- Perform a TV self diagnosis to determine if the problem is caused by the TV or the device ( >  Settings > Support > Device Care > Self Diagnosis > Picture Test or Sound Test).
- If the test results are normal, reboot the connected devices by unplugging each device's power cord and then plugging it in again. If the issue persists, refer to the connection guide in the user manual of the connected device.
- If you are not using a cable box or satellite box, and your TV is receiving TV signals from an antenna or a cable wall connector, run Auto Tuning to search for channels ( >  Settings > Broadcasting > (Auto Tuning Settings) > Auto Tuning).
 - The Auto Tuning Settings may not appear depending on the model or geographical

area.

– If you are using a cable box or satellite box, please refer to the cable box or satellite box manual



The remote control does not work.

- Check if the power indicator at the top left of the TV blinks when you press the remote's Power button. If it does not, replace the remote control's batteries.
- Make sure that the batteries are installed with their poles (+/-) in the correct direction.
- Try pointing the remote directly at the TV from 1.5-1.8 m away.
- If your TV came with a Samsung Smart Remote (Bluetooth Remote), make sure to pair the remote to the TV.



The cable box or satellite box remote control doesn't turn the TV on or off or adjust the volume.

- Programme the cable box or satellite box remote control to operate the TV. Refer to the cable box or satellite box user manual for the SAMSUNG TV code.

The TV settings are lost after 5 minutes.

- The TV is in the Retail Mode. Change the Usage Mode in the General Menu to Home Mode ( >  Settings > General > System Manager > Usage Mode > Home Mode).

Intermittent Wi-Fi

- Make sure the TV has a network connection ( >  Settings > General > Network > Network Status).
- Make sure the Wi-Fi password is entered correctly.
- Check the distance between the TV and the modem or access point. The distance should not exceed 15.2 m.
- Reduce interference by not using or turning off wireless devices. Also, verify that there are no obstacles between the TV and the modem or access point. (The Wi-Fi strength can be decreased by appliances, cordless phones, stone walls/fireplaces, etc.)

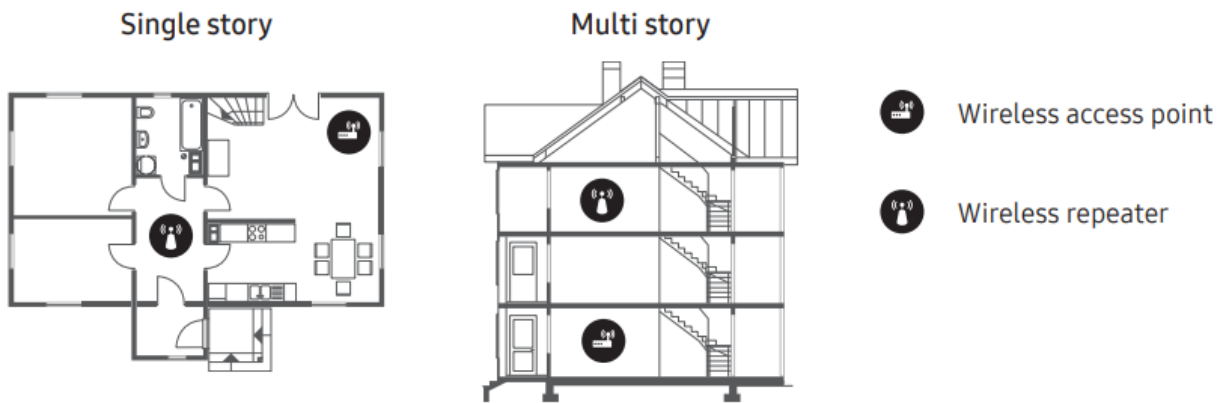

- Contact your Internet Service Provider (ISP) and ask them to reset your network circuit to re-register the MAC addresses of your modem or access point and the TV.

Video Apps problems (Youtube etc)

Change the DNS to 8.8.8.8. Select > Settings > General > Network > Network Status > IP Settings > DNS setting > Enter manually > DNS Server > enter 8.8.8.8 > OK.

Reset by selecting > Settings > Support > Device Care > Self Diagnosis > Reset Smart Hub.

Precautions when using Art mode

- The performance of the sensor may vary depending on the TV installation and operating environment.
 - The screen brightness and colour tone may be affected depending on the colour of the floor on which the TV stands.
 - If the area around the TV is too dark or bright, the screen brightness may be limited or the sensor may not work normally.
 - If the TV is installed too high or too low, the sensor may not work normally.
- Depending on the Auto Power Off (> Settings > General > Eco Solution > Auto Power Off) function settings, the TV may turn off when there is no user input in Art mode, such as inputs from the remote control.
- > Settings > General > System Manager > Time > Sleep Timer and Off Timer function does not work in Art mode.
- > Settings > General > System Manager > Auto Protection Time function does not work in Art mode.



What is Remote Support?

Samsung Remote Support service offers you one-on-one support with a Samsung Technician who can remotely:

- Diagnose your TV
- Adjust the TV settings for you
- Perform a factory reset on your TV
- Install recommended firmware updates

How does Remote Support work?



You can easily get Samsung Remote Support service for your TV:

1. Call the Samsung service center and ask for remote support.
2. Open the menu on your TV and go to the Support menu. ( >  Settings > Support)
3. Select Remote Management, then read and agree to the service agreements. When the PIN screen appears, provide the PIN number to the technician.
4. The technician will then access your TV.

Eco Sensor and screen brightness



Eco Sensor adjusts the brightness of the TV automatically. This feature measures the light in your room and optimises the brightness of the TV automatically to reduce power consumption. If you

want to turn this off, go to  >  Settings > General > Eco Solution > Ambient Light Detection.

- If the screen is too dark while you are watching TV in a dark environment, it may be due to the Ambient Light Detection function.
- The eco sensor is located at the top left of the TV. Do not block the sensor with any object. This can decrease picture brightness

Caring for the TV

- If a sticker was attached to the TV screen, some debris can remain after you remove the sticker. Please clean the debris off before watching TV.
- The exterior and screen of the TV can get scratched during cleaning. Be sure to wipe the exterior and screen carefully using a soft cloth to prevent scratches.

- Do not spray water or any liquid directly onto the TV. Any liquid that goes into the product may cause a failure, fire, or electric shock.
- To clean the screen, turn off the TV, then gently wipe away smudges and fingerprints on the panel with a micro-fiber cloth. Clean the body or panel of the TV with a micro-fiber cloth dampened with a small amount of water. After that, remove the moisture with a dry cloth. While cleaning, do not apply strong force to the surface of the panel because it can damage the panel. Never use flammable liquids (benzene, thinner, etc.) or a cleaning agent. For stubborn smudges, spray a small amount of screen cleaner on a micro-fiber cloth, and then use the cloth to wipe away the smudges.

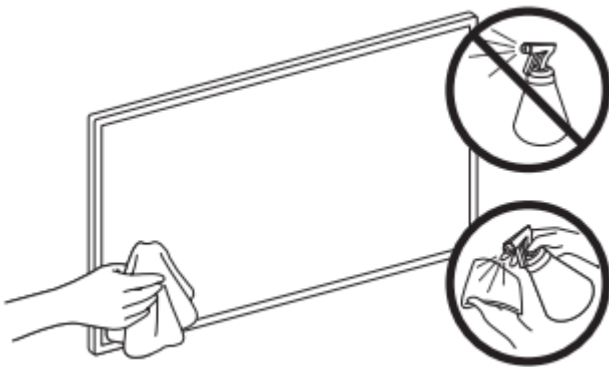

Warning

This content is compiled from multiple sources and is provided for reference purposes only. It may not be complete or fully applicable to all situations. If you are unable to resolve your issue, please contact the product manufacturer or an authorized service provider for official support.