

Getting Started

Appliance overview

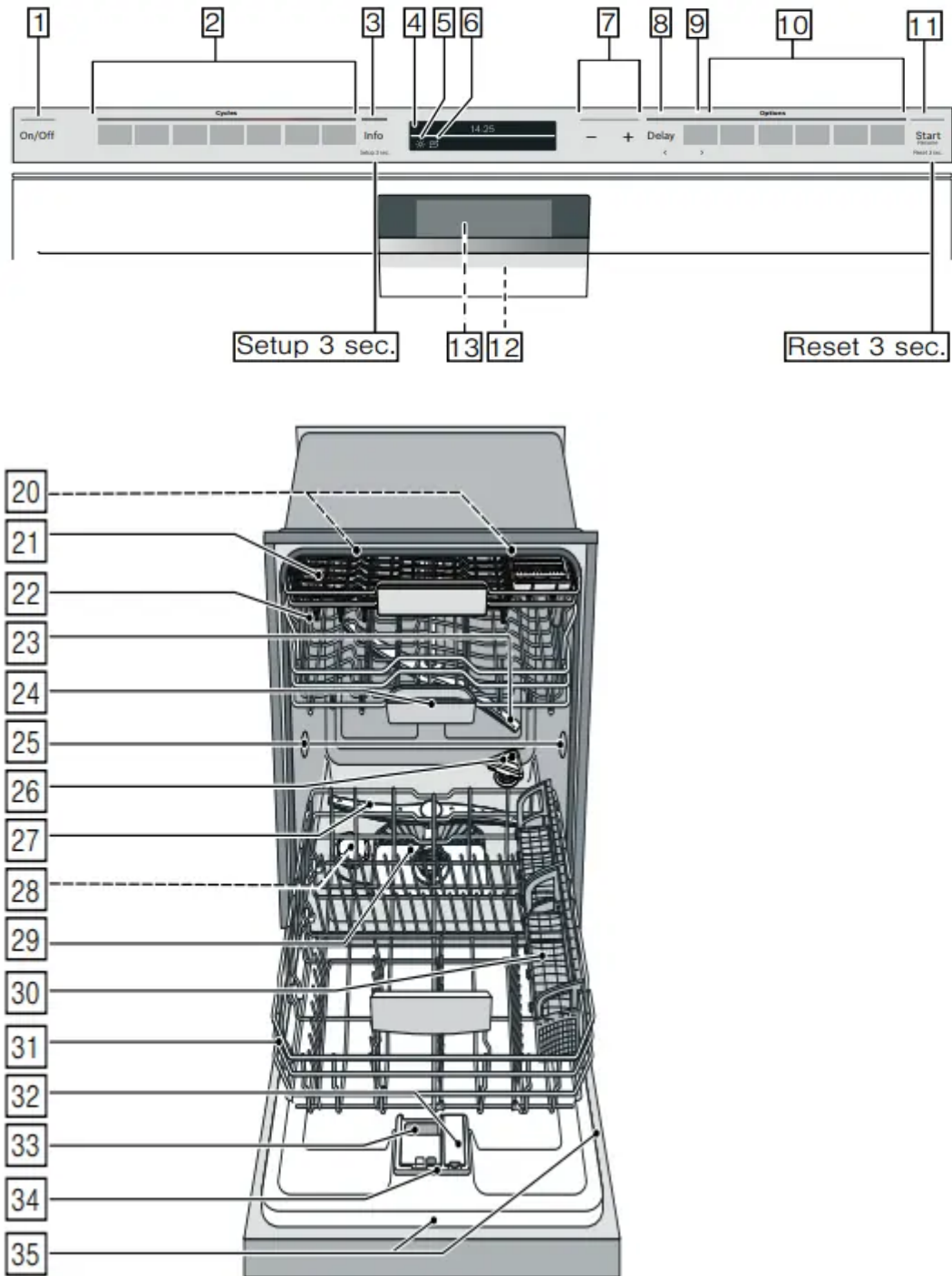

The numbers stated below refer to the overview images on the previous page of this manual.

Operating panel

- 1 On/Off button
- 2 Wash cycles**
- 3 Info button **i**
- 4 Digital display
- 5 Rinse aid refill indicator
- 6 Salt refill indicator
- 7 Selection buttons
- 8 Delay start / < button
- 9 Remote start / > button
- 10 Wash cycle options**
- 11 START button
- 12 Door handle*
- 13 Front display*

* optional feature which may or may not be included with your dishwasher.

** the wash cycles and options will vary by model

Dishwasher interior components

- 20 Interior light *
- 21 Third rack
- 22 Upper rack
- 23 Upper spray arm
- 24 Detergent tab tray
- 26 Zeolite outlet cover (zeolite container)
- 27 Lower spray arm
- 28 Dispenser for special salt
- 29 Filters
- 30 Silverware basket *
- 31 Lower rack
- 32 Rinse aid dispenser
- 33 Detergent dispenser
- 34 Lock for detergent dispenser
- 35 Rating plate

* optional feature which may or may not be included with your dishwasher.

Display indicators

- 0:00** **Cycle time remaining**
- *** **Refill rinse aid indicator**
Lights up when rinse aid is low
- S** **Refill salt indicator**
Lights up when salt is low

Info button

The Info button **3** can be used to display additional wash cycle information.

1. Press the Info button .
2. Press the wash cycle button. Information on the selected wash cycle is indicated on the display window at the top .
3. To leave, press Info button .

Time setting

When the appliance is switched on for the first time, the time starts at 12:00 o'clock.

Set the time as follows:

1. Open the door.
2. Switch on On/Off switch .
3. Press Info button for 3 seconds until the following text is indicated on the display window at the top :
Scroll with < >
Set with - +
Leave with Setup 3 sec.
4. Keep pressing button > until the time setting is indicated on the display window at the top .
5. Make the setting with setting buttons + - . If the selection buttons + - are held down, the set values are changed in 10-minute increments.
6. Press and hold the Info button for 3 seconds.

The selected setting has now been stored.

Note: If the appliance was disconnected from the power supply for a prolonged period, the time starts at 12:00 o'clock. Set the time.

Switching on the appliance for the first time

When the dishwasher is switched on for the first time, you are taken directly to the settings for switching on the appliance for the first time.

The following text is indicated on the display window at the top .

- Scroll with < >
Set with + -
Leave with Setup 3 sec.

The required settings for switching on the appliance for the first time are listed in the table below.

Change the setting as follows:

1. Keep pressing button > **8** until the required setting is displayed.
2. Make the selection with setting buttons + - **7**.
3. Press and hold the Info button **3** for 3 seconds. The selected setting has now been stored.

Settings Switching on the appli- ance for the first time	Factory setting	Infotext by pressing Info button
Language	American English	Language selection.
Time format	12h	12h or 24h.
Time setting	12:00	Set the current time.
Water hardness	°E0-8 Soft	Setting water hardness. When using Multitabs, select the lowest setting.
Rinse aid dispenser	Level 5	Amount of rinse aid affects drying. When using Multitabs, select setting 0.

Settings

The dishwasher has been preset with certain settings for your convenience. You can change these factory settings.

Change the setting as follows:

1. Open the door.
2. Switch on On/Off switch **1**.
3. Press Info button **3** for 3 seconds until the following text is indicated on the display window at the top **4**:

Scroll with < >

Set with - +

Leave with Setup 3 sec.

4. Keep pressing button > **8** until the required setting is displayed.
5. Make the selection with setting buttons + - **7**.
6. Press and hold the Info button **3** for 3 seconds.

The chosen setting has now been stored.

You have the option of resetting all changed settings back to the original factory settings.

Note: When you reset your dishwasher to the factory settings, you are taken directly to the settings for switching on the dishwasher for the first time.

Setting	Factory setting	Infotext by pressing Info button
Time setting	12:00	Set the current time.
Time format	12h	12h or 24h.
Time display	Time	Show end of wash cycle with display "Finish in" or "Finish at".
Language	American English	Language selection.
Water hardness	°E 0	Setting water hardness. When using Multitabs, select the lowest setting.
Rinse aid disp.	Level 5	Amount of rinse aid affects drying. When using Multitabs, select setting 0.
Sensor setting	Standard	Adjusting water clarity detection for best cleaning results.
Extra dry	Off	Improved drying for glasses and plasticware.
Eco forecast	Off	Show the water and energy consumption.
Auto Power Off	Off	Appliance automatically switches off at end of rinsing process.
Emotion Light *	On	Interior light.
Front display *	On	The front display can be selected.
Remaining time proj. *	On	While wash cycle is running, status information is projected onto floor.
Infolight *	On	Light is projected to signal an active wash cycle.

* depending on the features of your dishwasher

Setting	Factory setting	Infotext by pressing Info button
Start program	Auto 130-150° F	When switching on, the last selected wash cycle appears.
Tone volume	Level 2	Volume of signal at end of wash cycle.
Button volume *	Level 2	Volume when using buttons.
Wi-Fi	on/off	Switch wireless network connection on or off.
Network login	Manual or Autom./ WSP	Check WPS function on router. No WPS function: Manual WPS function: Automatic
Connect to the app	Start with +	Connect appliance to mobile terminal device.
Greeting	On	When switching on the appliance, the brand logo can be deselected.
Factory setting	Reset	Resetting to the factory setting.

* depending on the features of your dishwasher

Notes

- The "Network login" menu option is only available if Wi-Fi has been switched on.
- The "Connect to App" menu option is only available if a connection to the home network has been established.

Home Connect

This dishwasher is Wi-Fi capable and can be remotely controlled via a mobile device.

If your dishwasher does not connect to the home network, you can also operate the dishwasher manually by pressing the buttons.

Refer to appliance overview for the location of the buttons. → "Appliance overview" on page 12

Info button

The Info button 8 can be used to display additional wash cycle information.

1. Press the Info button **3**.
2. Press the wash cycle button. Information on the selected wash cycle is indicated on the display window at the top **4**.
3. To leave, press Info button **3**.

Setting up the app

To be able to operate the appliance via Home Connect, the Home Connect app must be installed on your mobile device.

Observe the supplied Home Connect documents with regard to this.

Follow the steps specified by the app to implement the settings.

Setting up Home Connect

You can set your dishwasher by pressing the remote start button **9** or proceed as follows:

1. Open the door.
2. Switch on the On/Off switch **1**.
3. Press Info button **3** for 3 seconds until the following text is indicated on the display window at the top **4**:

Scroll with < >

Set with - +

Leave with Setup 3 sec.
4. Keep pressing button > **8** until the required setting is indicated on the display window at the top **4**.
5. Make the setting with setting buttons + - **7**. See table in section ~ "Settings" on page 15

6. Press and hold the Info button 3 for 3 seconds.

The chosen setting has now been stored.

Wi-Fi

In the Wi-Fi menu you can activate the wireless network connection with “on” and deactivate it with “off”.



Notes

- If you have selected the Wi-Fi “off” setting, the “Network login” and “Connect to App” settings are not available.
- Remote control of the appliance requires a stable wireless network connection.

Network login

The “Network login” menu option is not available unless you have activated Wi-Fi.

In the “Network login” menu you can select between “Autom./WPS” and “Manual” to connect the dishwasher to your home network.

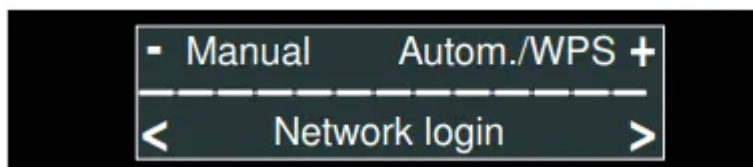

Automatic: Connect to the home network using the WPS function of your router.

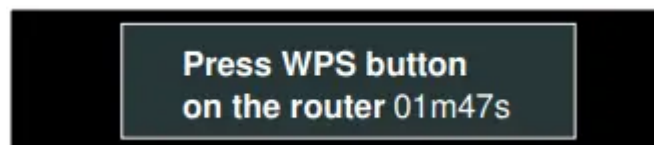

Manual: Connect your mobile device to the Home Connect network. The network settings are then manually entered using the Home Connect App to connect to your home network.

Following successful connection, the following text is indicated on the display window at the top 4.

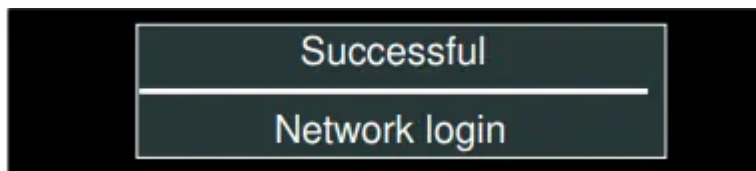

Observe the supplied Home Connect documents with regard to this.

Connect to App

The “Connect to App” menu option is not available unless there was a connection to the home network.

The “Connect to App” setting establishes the link between the dishwasher, App and your user account.

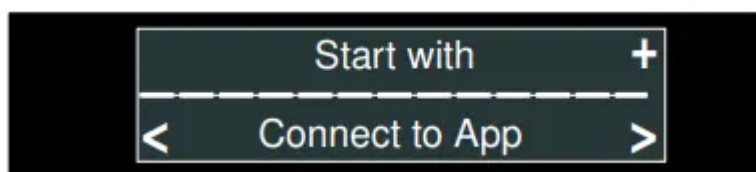

Following successful connection, the following text is indicated on the display window at the top 4.

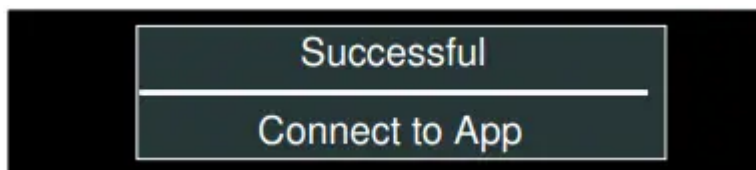

Observe the supplied Home Connect documents with regard to this.

About data protection:

When your Home Connect dishwasher is connected for the first time to a WLAN network which is connected to the Internet, your Home Connect dishwasher transmits the following categories of data to the Home Connect server (initial registration):

- Unique appliance identification (consisting of appliance codes as well as the MAC address of the installed Wi-Fi communication module).
- Security certificate of the Wi-Fi communication module (to ensure a secure IT connection).
- The current software and hardware version of your dishwasher.
- Status of any previous resetting to factory settings.

This initial registration prepares the Home Connect functions for use and is activated the first time you use these Home Connect functions.



Please note that the Home Connect functions can be used only in conjunction with the Home Connect App. Information on data protection can be accessed in the Home Connect App.

Remote start button



Once the dishwasher is connected to the home network, press the remote start button  to control the dishwasher from your device.

If the dishwasher has still not logged into Home Connect, access the Home Connect settings by pressing the remote start button .

Follow the directions in Home Connect app.

Note: Your dishwasher is protected against unintentional operation. If the appliance door remains open for more than 4 seconds after pressing the Remote Start button , the operation will be paused. Press the Remote Start button  again and close the appliance door. Also see section → "Protection against unintentional operation" on page 43

Notes

- When the login process is complete, the Remote Start button  goes out.
- To activate the remote control, press the Remote Start button .
- If the Home Connect Assistant was aborted during start-up, press the Remote Start button  again.
- If the connection to the router fails, the Wi-Fi symbol flashes on the display.
- Opening the door deactivates Remote control.

Wi-Fi without a connection to the Home Connect server

You can use the Home Connect App to disconnect from the Home Connect server.

The appliance is then locally connected to your mobile device without any connection to the Home Connect server.



Note: If you did not deactivate the connection to the Home Connect server, check your Internet connection.

Remote diagnosis

Customer Service can use Remote Customer Service  to access your appliance if you contact them.

Notes

- You have to confirm Customer Service access on your appliance.

- You can switch off Remote Customer Service  using the On/Off switch  or deactivate Customer Service access in the Home Connect App.

Rinse Aid

To achieve proper drying, always use a liquid rinse aid, even if your detergent contains a rinse aid or drying additive.

Note: The dishwasher indicates low rinse aid by turning on the Rinse Aid indicator. If this indicator lights up, you need to refill the rinse aid dispenser  by following the directions below.

Adding rinse aid

NOTICE To avoid oversudsing or clogging, do not overfill the rinse aid dispenser . Wipe up any spills with a damp cloth.

1. Open the rinse aid dispenser  by pressing on the latch of the lid and pull it open.

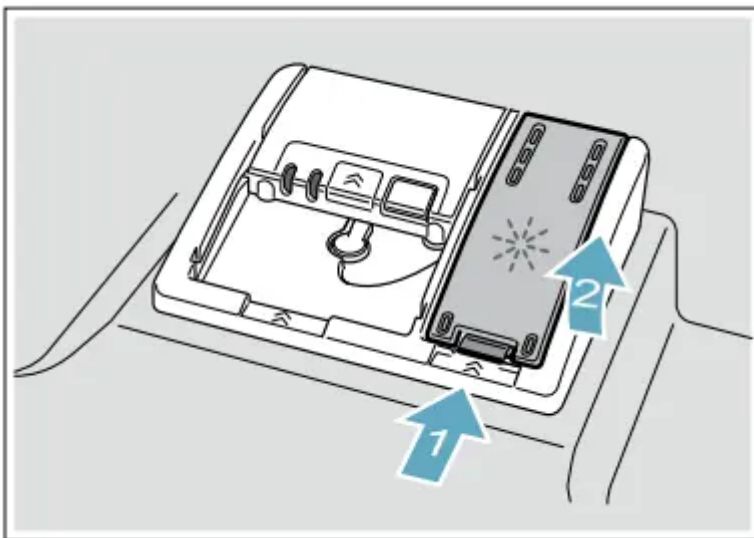

2. Add liquid rinse aid to the dispenser  until it is full. Do not overfill. Avoid spilling into air vent hole.

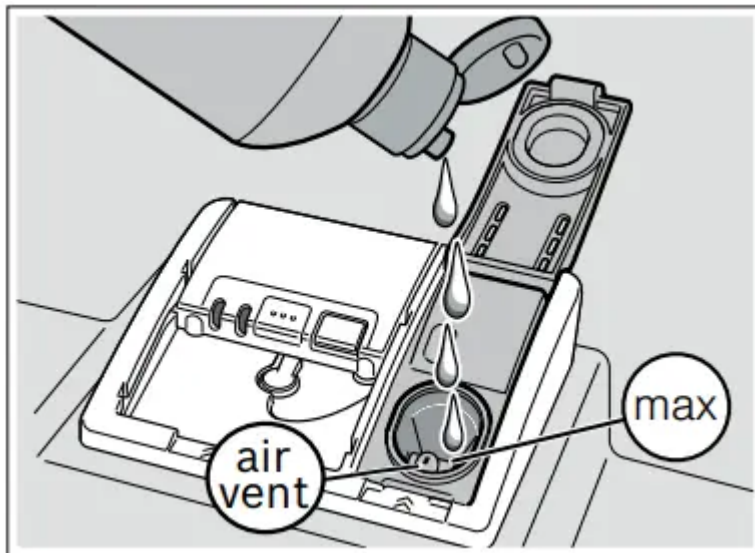

3. Close the lid. Lid must be fully closed until it clicks in order to seal.

4. Wipe up any excess rinse aid that may have puddled when the dispenser reservoir is full.

The indicator light will go out a few moments after the dishwasher door is shut.

Tip: For easier pouring, remove lid from the rinse aid bottle.

NOTICE Do not fill the rinse aid dispenser **32** with detergent. Doing so will damage the dishwasher.

Setting the amount of rinse aid used

The amount of rinse aid dispensed can be set from 0 to 6. Set the amount of rinse aid to be dispensed to 5 to obtain a very good drying result.

You should only change the setting if streaks remain on the dishes (lower the amount), or if dishes are not getting dry enough (increase the amount).

Set the amount of rinse aid as follows:

1. Open the door.

2. Switch on On/Off button **1**.

3. Press Info button **3** for 3 seconds until the following text is indicated on the display window at the top **4**:

Scroll with < >

Set with - +

Leave with Setup 3 sec.

4. Keep pressing button > **8** until the rinse aid dispenser is indicated on the display window at the top **4**.

5. Make the selection with setting buttons + - .

6. Press and hold the Info button for 3 seconds.

The chosen setting has now been stored.

Turning off rinse aid indicator

Proceed as described in the section “Setting the amount of rinse aid used” and set value to 0. The rinse aid indicator is now turned off.

NOTICE Using no rinse aid or setting the dispenser to 0 may result in longer cycle times consuming more energy and water. The higher temperatures and longer cycle times can damage fine china or glassware.

Loading the Dishwasher

Dishware material

Note: Before using your dishwasher for the first time, check the information in this section. Some items are not dishwasher-safe and should be hand washed; others require special loading.

Recommended

Aluminum	Colored anodized aluminum may fade over time. Minerals in your water may cause the aluminum to darken or spot. This can usually be removed with a soap-filled steel wool pad.
China, Crystal, Stoneware	Some hand-painted utensils may discolor, fade or spot. Hand wash these utensils. Position fragile glassware so that it will not topple over or come in contact with other utensils during the wash cycle.
Glass	Make sure to use dishwasher-safe glass. Milk glass may discolor or become yellow.
Non-stick Coatings	Apply a light coating of vegetable oil to non-stick surfaces after drying.
Plastics	Make sure the plasticware is dishwasher-safe.
Stainless Steel, Sterling Silver and Silver Plates	Load these so they do not come in contact with other metals, stainless steel dishwasher tub walls or the inner door.

Not Recommended

Acrylic	Crazing or small cracks throughout the acrylic, may occur.
AdhesiveJoined Pieces	Adhesives that join materials such as plastic, wood, bone, steel, copper, tin, etc. may loosen.
Bone-Handled Utensils	Handles may separate.
Iron	Iron will rust. Hand wash and dry immediately
Non-Dishware Items	Your dishwasher is intended for use in cleaning ONLY standard household dishware and kitchenware.
Pewter, Brass, Bronze	These items will tarnish. Hand wash and dry immediately.
Tin	Tin will stain. Hand wash and dry immediately.
Wood	Wooden bowls, wooden utensils and utensils with wooden handles can crack, warp and lose their finish.

Loading the racks

For best dishwashing results, observe the following when loading the dishwasher:

- Do not pre-wash items with loosely attached food soil.
- Remove all food particles, bones, toothpicks and excessive grease.
- Pre-treat items having burned-on, baked-on or starchy soils.
- Load dishes in the dishwasher racks so the insides of bowls, pots and pans are facing the spray arms.
- Avoid nesting and contact points between dishes.
- Separate items of dissimilar metals. Use care to not block movement of the spray arms.
- Only wash household dishware and kitchenware rated as dishwasher-safe.

Refer to the Dishware Materials section for more information about dishware suitability.

NOTICE To avoid dishwasher damage, do not load the dishwasher with paper products, plastic bags, packing materials or anything other than normal, dishwasher safe dishware and kitchenware.

Loading the upper rack

Ensure items do not protrude through the bottom of the racks and block the spray arms.

Note: When pushing the upper rack **22** into the dishwasher, push it until it stops against the back of the tub so the upper rack spray arm **23** connects to the water supply at the back of the tub. Do not push racks in using the door.

Loading the lower rack

Place large items in the lower rack **31**. Load pots, pans and bowls upside down. Do not block the vent hole **25** with tall baking sheets.

Load these items on the right side of the dishwasher.

Dishwasher Cycle Options

Delay

Allows you to delay the start time of your dishwasher up to 24 hours.

SpeedPerfect™

SpeedPerfect™ is an option that allows saving time without sacrificing wash and dry performance. Selecting this option ensures the same final temperatures as the underlying cycle by starting the heat period at an earlier phase in the program.

Selecting this option also increases energy consumption while reducing cycle time.

Half Load

Can reduce water consumption when washing small, lightly soiled loads that fill approximately half or less of the dishwasher's capacity.

Delicate

This option's reduced time and temperature are best for lightly soiled items with easy to remove food soils.

The option also reduces the likelihood of cloudy glasses. Rinse aid is recommended for the high gloss drying function (even when using combination detergents).

Sanitize

Increases the temperatures and retains them for an extra long time to obtain a defined disinfecting performance. Continuous use of this function increases the hygiene status. This additional option is ideal for cleaning items such as chopping boards and baby bottles.

"Sanitized" will appear in the display window when sanitation requirements are met. Using the Sanitize option may also improve drying. There is a slight increase in energy consumption.

CrystalDry™

Patented CrystalDry™ technology thoroughly dries dishes and plastics such as baby bottles and food storage containers. Natural minerals transform moisture into heat up to 176F to get dishes, even plastics 60% drier.*

* Based on aggregate average drying performance of Bosch Dishwashers with CrystalDry™ on combined household load including plastics, glass, steel, and porcelain as compared to Bosch Dishwashers with PureDry. Drying performance may vary by dish type.

Operating the Dishwasher

Note: With hidden controls, the door must be opened before changing settings and closed after changing settings.

Protection against unintentional operation

Your dishwasher is equipped with a function that helps to prevent unintentional operation (e.g. by children).

After starting the dishwasher, the dishwasher door has to be closed within 4 seconds, otherwise the operation will be paused. There will be a signal on the control panel advising you to press the Start button again and close the door.

This function will be activated when:

- pressing Start to begin a wash cycle
- setting Delay time and pressing Start
- opening the door while Delay time is active
- opening the door during a wash cycle.

Note: This function cannot be deactivated.

Operating the touch buttons

Buttons are sensitive and should be touched gently. Avoid any grease or food particles resting on the buttons as they could activate the dishwasher.

Wiping and cleaning can also activate the dishwasher. For best results, use bare, clean hands when touching the buttons.

To clean the touch buttons wipe them with a dry or slightly damp cloth.

Changing the settings

The dishwasher has been preset with certain settings for your convenience.

You can change these factory settings.

Change the setting as follows:

1. Open the door.
2. Switch on On/Off button .
3. Press Info button for 3 seconds until the following text is indicated in the digital display :
 - Scroll with < >
 - Set with - +
 - Leave with Setup 3 sec.
4. Keep pressing button > until the required setting is indicated in the display window at the top .
5. Make the selection with setting buttons + - .
6. Press and hold the Info button for 3 seconds.

The chosen setting has now been stored.

Tip: If you change several settings, first make all changes in succession. Now press the Info button for 3 seconds. This saves all set values in the appliance.

AquaSensor

The AquaSensor is an optical measuring device which measures the cleanliness of the rinse water.

The AquaSensor is used according to the wash cycle. If the AquaSensor is active, "clean" rinse water can be transferred to the next rinse and water consumption can be reduced by 0.8–1.5 gal (3–6 liters). If the rinse water is not yet clear, the water is drained and is replaced with fresh water. In the automatic wash cycles the temperature and running time can also be adjusted to the degree of soiling.

Time display

The wash cycle time is determined during the wash cycle by the water temperature, the amount of dishes, as well as the degree of soiling and may vary (depending on the selected wash cycle). You can change the time display into time of day or hours/minutes so that the remaining cycle time of the wash cycle appears in the display window "Finish at" (for example 15:20 o'clock) or "Finish in" (for example 3:25 hours).

Sensor setting

The wash cycle sequence is optimized in Auto wash cycles with the aid of sensors. The sensors adjust the wash cycle strength of Auto wash cycles depending on the amount and type of soiling. You can adjust the sensitivity of the sensors in 3 stages.

Standard: This setting is recommended for daily regular or typical use. This is the most energy efficient setting.

Sensitive: This setting adjusts the wash cycle strength for the effective removal of food remnants, even if the amount of soiling is low. The energy and water consumption is increased accordingly.

Very sensitive: This setting adjusts the wash cycle strength for difficult conditions of use, for example firmly dried on food remnants. This setting is recommended if using biological or eco detergents which contain lower amounts of active agents. The energy and water consumption is increased accordingly.

Extra Dry

The final rinse uses a higher temperature which improves the drying result. The cycle time may increase slightly. (Caution if utensils are delicate!) You can switch the Extra Dry function on or off. There is a slight increase in energy consumption.

Eco forecast

When Eco forecast is activated, the average water and energy consumption of the selected wash cycle is briefly displayed in the digital display .

Auto power off

This setting determines the length of time the control panel stays illuminated after the cycle is complete.

To save energy, the recommended setting is “after one minute”.

Possible settings are:

- off: The appliance does not switch off automatically.
- After one minute: The appliance switches off after 1 minute. This is the most energy efficient setting.
- After two hours: The appliance switches off after 2 hours.

Tone volume

The end of the wash cycle is indicated by a buzzer. You can also change this setting.

Button volume

When you are operating the dishwasher, a signal sounds whenever a button is pressed. You can control the volume of the signal. If you do not like the button volume, you can switch it off.

Greeting

When you switch on the dishwasher, the brand logo appears. You can switch off the brand logo.

Factory setting

You can reset all settings to the factory setting.

Switching the appliance on

1. Turn the water supply on fully.
2. Open the door.
3. Switch on On/Off switch . The Auto wash cycle has been preset as a default whenever the appliance starts. This wash cycle remains selected if no other wash cycle button is pressed.
4. Press Start button .
5. Close the door.

Wash cycle sequence starts.

Note: Your dishwasher is protected against unintentional operation. If the appliance door remains open for more than 4 seconds after pressing the Start button, the operation will be paused. Press the Start button again and close the appliance door.

Delay start time

You can delay the start of the wash cycle by up to 24 hours. Depending on the setting of the time display, the end of cycle is indicated with "Finish in" (for example 3h 25m) or "Finish at" (for example 15:20 hours).

1. Open the door.
2. Switch on On/Off switch .
3. Select wash cycle .
4. Press Delay start button .
5. Keep pressing the setting buttons + - until the displayed time corresponds with your requirements.

6. Press Start button , timer programming is activated.
7. To delete the Delay start time, press Start button for about 3 seconds.
8. Close the door.

Note: Your dishwasher is protected against unintentional operation. If the appliance door remains open for more than 4 seconds after pressing the Start button, the operation will be paused. Press the Start button again and close the appliance door.

InfoLight® *

* depending on the features of your dishwasher

While the wash cycle is running, a light spot shines on the floor under the appliance door.

Do not open the appliance door until the light point is no longer visible on the floor.

If the appliance door is not completely closed, the light spot flashes.

If the appliance is installed at eye-level, with flush furniture front, the light point is not visible.

In darkened rooms, some light scattering may be visible. This is normal and cannot be changed.

You can switch the Infolight on or off.

EmotionLight

The EmotionLight is on when the door is open irrespective of whether the On/Off switch is switched on or off. When the door is closed, the EmotionLight is off. You can switch the EmotionLight on or off.

Note: Note that when the door is open the EmotionLight is automatically switched off after 1 hour.

Wash cycle end

The wash cycle has ended when "Finished" is indicated on the digital display(s).

Switching off the appliance

Short time after the end of the wash cycle:

1. Press On/Off button .
2. Remove the dishes when they have cooled down.

Care and Maintenance

Care and Maintenance A regular inspection and maintenance of your machine will help to prevent faults. This saves time and prevents future problems.

Cleaning the dishwasher

- Regularly wipe the front of the appliance with a damp cloth - water and a small amount of liquid soap is adequate.
- For black stainless steel and anti-fingerprint surfaces, use a soft, dry towel. For stubborn dirt, use warm water diluted with a non-abrasive, mild cleansing soap. Never use stainless steel polish.
- For stainless steel appliances (excluding black stainless and anti-fingerprint), use a stainless steel polish to seal and protect the surface.
- Clean the outer edges of the inside door panel regularly to remove debris that may collect from normal loading. If spots begin to appear on the stainless steel, make sure the rinse aid dispenser is full and functioning properly.
- Clean the door seal regularly with a damp cloth to remove food particles that may collect from normal loading and cause odor. A soiled door seal may not seal properly.

NOTICE

- Never use a steam cleaner to clean your dishwasher. The manufacturer is not liable for any resulting damage.
- Do not use sponges as they could scratch the surfaces.
- Do not use bleach-based wipes as they could damage the surface or printing.
- Never use stainless steel polish on a black stainless finish or anti-fingerprint surfaces.

Filters

The Bosch® filter system  is designed to prevent the need to pre-rinse normally attached food soils from your dishes. Simply scrape leftover food soils off of dishware before loading. This process will conserve time, water and the energy require to heat your household water supply.

Your dishwasher filter system is designed to filter 100% of the water entering the spray arms to provide a continuous supply of clean water to remove food soils from your dishware.

Filter components

The filter system  consists of three parts.

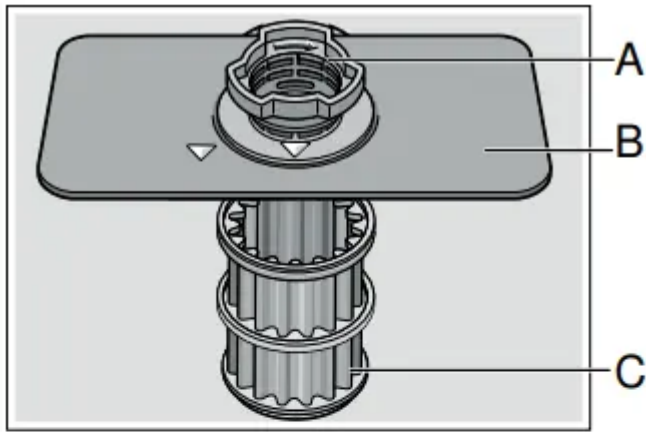

- A Large Object Trap**
Prevents objects that should not be placed in your dishwasher from damaging the dishwasher pump system or clogging your household drain.
- B Flat Fine Filter**
Prevents food particles from entering the wash chamber and directs particles toward the micro filter.
- C Micro Filter**
Directs the smallest of particles to the household plumbing drain.

Cleaning intervals

The filter system 29 is designed to minimize maintenance while providing premium cleaning performance and minimum energy consumption.

Depending on use habits and water hardness, the filter system will require some maintenance to sustain premium cleaning performance.

Your filter system may need to be cleaned when:

- You notice food soils remaining on the filter system or objects trapped in the Large Object Trap.
- A drop in cleaning performance or a gritty film forms on the dishware.

When washing normally attached food soils that have been scraped before loading, in a household that runs the dishwasher every other day, your filter should be cleaned:

Cleaning interval	Usage
3-6 times a year	light to average use
8-12 times a year	heavy use

Note: Clean the filter system after washing loads with large amounts of food soils or loads with a heavy starch content, like potatoes and pasta, to maintain optimal performance.

To check or clean the filter system:

1. Unscrew the Large Object Trap as illustrated and remove the entire filter system.

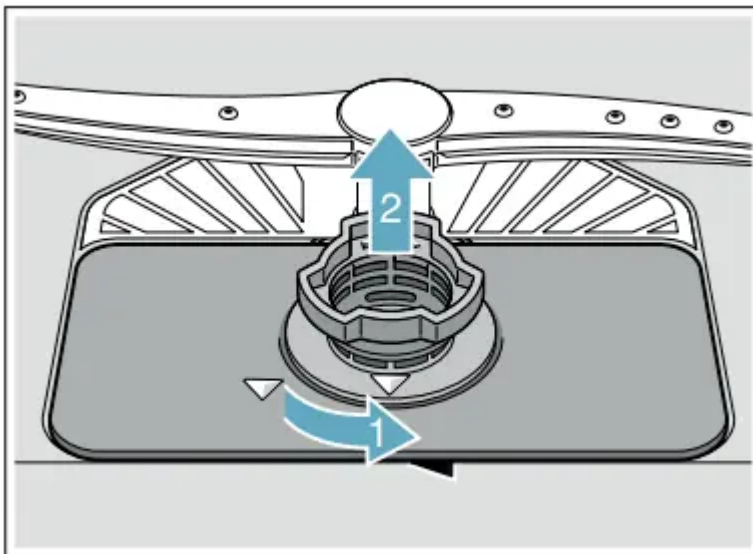

2. Remove the microfilter from the fine filter for easier cleaning.

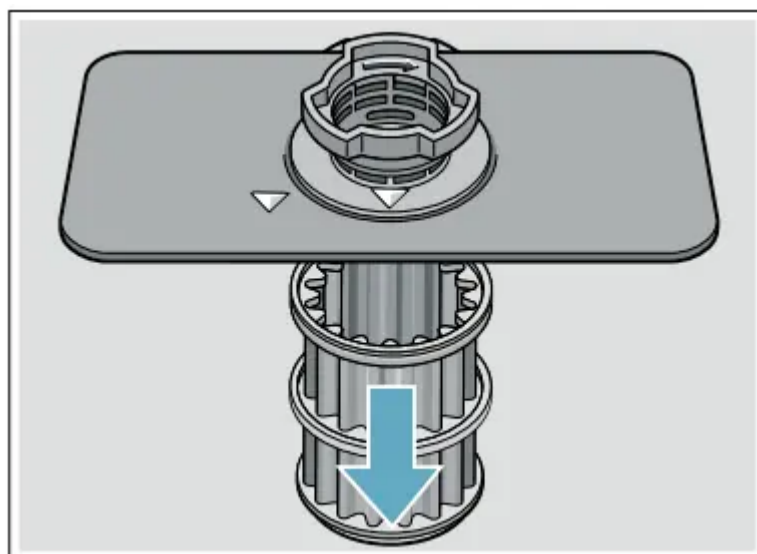

3. Rinse the filters under running water and use a soft brush to clean.

Note: do not use abrasive brushes or steel wool, etc., as they may damage the filter.

4. Reinstall the filter system in reverse sequence and lock into place by screwing the Large Object Trap until the marking arrows align.

Spray arms

Check spray arms **23**, **27** for grease and limescale deposits. If you find such deposits:

- Fill detergent dispenser **33** with detergent and start the appliance without utensils in the cycle with the highest rinsing temperature. → "Wash Cycle Information" on page 41
- Clean the appliance with detergents/appliance cleaners which are particularly suitable for use with dishwashers.
- Unscrew the upper spray arm **23** and pull off the lower spray **27** arm as shown. Inspect for deposits.

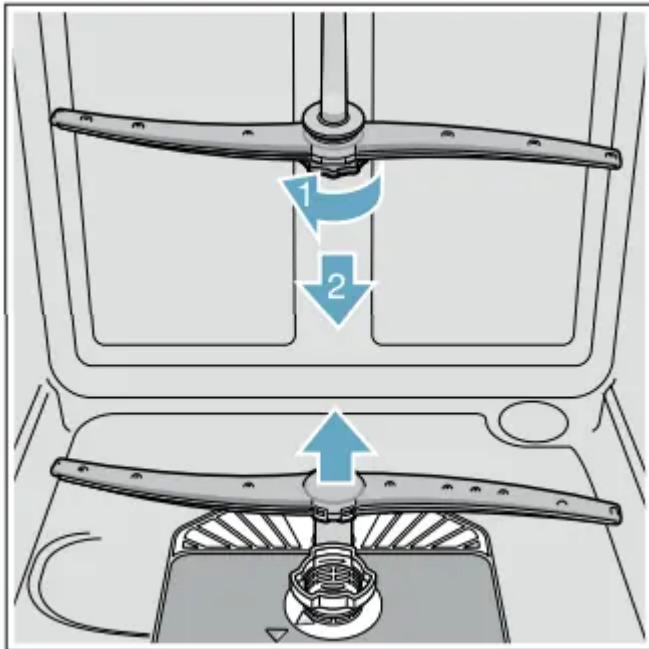

Drain pump

Large food remnants in the rinsing water not retained by the filters may block the waste water pump. In this case:

- Disconnect the appliance from the power supply.
- Remove the filters. → "Filters" on page 49
- Scoop out standing water - use a sponge if necessary.
- Using a spoon, pry off the pump cover until it clicks, then grip the cover and pull upward until it resists and then pull forward.

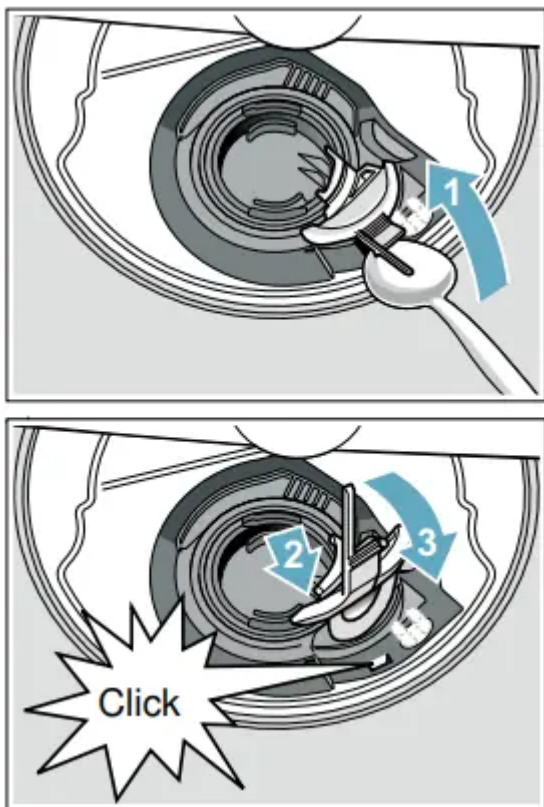

- Check inner compartment and remove any foreign objects.
- Place cover in the original position, press down and engage.
- Reinstall filters.

Note: The drain pump will not work properly if the drain pump cover is not snapped in completely until it clicks.

Troubleshooting

Dishwashers may occasionally exhibit problems that are unrelated to a malfunction of the dishwasher itself.

The following information may help you with a dishwasher problem without involving a repair professional.

Problem	Cause	Action
Error code E:18 is lit.	Supply hose kinked.	Install supply hose without kinks.
	Water supply turned off.	Turn on the water supply.
	Water supply line is clogged.	Unclog water line.
Error code E:22 is lit.	Water in sump since sump filters 29 are dirty or blocked.	Clean filters.
Error code E:24 is lit.	Drain line is clogged.	Unclog drain line.
	Drain hose is kinked, clogged or blocked.	Replace drain hose.
	Drain pump impeller (vanes) is clogged or blocked.	Remove drain pump cover, clean around pump impeller and replace cover.
	Drain pump cover was loose.	Lock drain pump cover into place in the sump.
Error code E:25 is lit.	Drain pump is blocked or pump cover is loose.	Clean drain pump and lock drain pump cover into place in the sump.
Error code E:27 is lit.	Supply voltage too low (less than 98 volts).	Not a dishwasher fault; have the supply voltage and electrical installation checked.
A different error code is indicated on the digital display. (E:01 to	A technical fault has probably occurred.	Switch off dishwasher with the On/Off switch 1 . After a short time restart the dishwasher.

<i>E:30)</i>		<p>If the problem recurs, turn off the tap and pull out the power supply plug.</p> <p>Call customer service and mention the error code.</p>
Home network is not loading.	Wi-Fi is not active on the router.	Check the wireless network connection of your router.
Wi-Fi display flashes	Connection to the home network is not available.	Activate the wireless network on your router.
Home Connect cannot be implemented correctly.	Possible setting errors or a technical fault.	Refer to the supplied documents and support information for Home Connect.



Dishwasher does not start.	Door may be ajar or not be properly latched.	Close door securely until door latch clicks.
	No power to the dishwasher (display won't come on). Fuse may have been blown, circuit breaker may have tripped, power cord may have been unplugged or dishwasher may have been turned off.	Replace blown fuse or reset tripped circuit breaker. Plug power cord into outlet securely. Press the on/off button  to turn the dishwasher on.
	Can't select a wash cycle since the previous wash cycle may not have finished or the dishwasher hasn't been reset.	Reset the dishwasher by pressing and holding the START button for at least three seconds.
	Delay start or Child lock may be activated.	Reset Delay start or Child lock functions (refer to the appropriate section in this manual).
	The door may have been closed without selecting a wash cycle.	Select a wash cycle and close the door.
	Water supply may not be turned on or connected.	Check and turn on water supply.
Wash cycle won't resume after door was opened and closed.	The door has been open for more than 4 seconds after pressing the Start button.	Press Start button again and close the dishwasher door within 4 seconds (see "Protection against unintentional operation" section in this manual).
Wash cycle abruptly stops.	Door may be ajar or not properly latched.	Close door securely until door latch clicks.

<p>Objects placed into the upper rack handle tray prevented the door from being closed securely.</p>	<p>Remove objects from upper rack handle tray and close door securely until door latch clicks.</p>
<p>Power and/or water supply interrupted.</p>	<p>Restore power and/or water supply.</p>



Dishwasher runs a long time.	Incoming water is not warm enough.	Before starting a cycle, run hot water faucet at the sink closest to the dishwasher.
	Cycle time depends on wash cycle chosen and amount of soil on dishes (dishwasher sensors increase cycle times to ensure dishes are clean when heavy soil is detected).	Scrape food off of dishes and use less intensive wash cycles.
	Rinse aid dispenser 32 is empty, or rinse aid setting = 0. Without rinse aid, wash cycle defaults to longest time with most number of washes and rinses.	Add rinse aid and change rinse aid setting depending on water hardness.
	Dishwasher is connected to cold water supply.	Connect dishwasher to hot water supply.
Dishes aren't clean enough	Spray arms are blocked or misaligned where they cannot rotate freely.	Make sure spray arms 23 , 27 can rotate freely.
	Little or no water spray due to clogged spray arm nozzle.	Clean out spray arm nozzles and filters of all debris and obstructions. → "Spray arms" on page 50
	Little or no water spray due to clogged or misaligned filters 29 .	Clean filters and make sure they're installed correctly. → "Filter components" on page 49
		Space dishes apart so spray jets can reach the surface of the dishes and

	Dishes are nested or placed too closely together and racks are overfilled.	dishes don't contact each other. → <i>"Loading the Dishwasher" on page 25</i>
	Improper or ineffective wash cycle or detergent used.	Choose a more intensive wash cycle and use appropriate dishwasher detergents. → <i>"Wash Cycle Information" on page 41</i>
	Detergent is made less effective due to hard water.	Install a water softener and choose a more intensive wash cycle.
Removable spots or streaks on glasses and silverware.	Too much rinse aid causes streaks and too little rinse aid can cause spots.	Add rinse aid and check rinse aid setting (recommended setting 4-5). → <i>"Rinse Aid" on page 23</i>
	Mineral deposits from hard water.	Install a water softener.
	Water from top (3rd) or upper rack dripped on racks below.	Unload lower rack 1st, upper rack 2nd and top (3rd) rack last.

Dishes not dry.	Rinse aid dispenser 32 is empty or incorrect rinse aid amount is set.	Add rinse aid or adjust setting - the use of rinse agent improves drying, use the Auto cycle, use the Sanitize option.
	Extra Dry heat option not chosen.*	Activate Extra Dry heat option.*
	Water collected in depressions on the dishes and silverware.	Arrange dishes in upper rack to slope so water can drain.
	Door was opened or dishes removed before wash cycle was completed.	Wait until wash cycle ends before opening door or removing dishes.
	Plastics don't absorb heat like cutlery or china and don't dry as well.	Use more intensive wash cycles (with hotter rinse water) or activate Extra Dry heat option.*
	Silverware not arranged properly in the silverware basket or top rack.	Arrange silverware properly and separate them so they don't contact each other.
Refill indicator for salt and/or rinse-aid is displayed or lit.*	No rinse aid.	Refill rinse aid.
	No salt (or sensor doesn't detect salt tablets).	Refill with dishwasher softener salt.
Odor Note: Water testing is done	Food debris in the dishwasher sump and door seal.	Clean sump filters, sump and door seal as needed. → <i>"Care and Maintenance" on page 48</i>

in the factory.
Occasionally water may still appear in dish-

washer at purchase which may create an odor.	Food debris left on dishes too long.	Run dishwasher more frequently.
	Not using rinse aid or using improper detergent.	Use rinse aid and the proper detergent.
	Residual standing water in the sump.	Make sure previous wash cycle has finished.
	Drain line is clogged or drain hose is kinked, clogged or blocked. Or drain hose was not installed with a high loop.	Unclog drain line or replace drain hose. Be sure drain hose is installed with high-loop. Note: If odor still persists, run the Normal/Regular cycle until it flushes and interrupt the cycle and place an 8 oz. cup of distilled white vinegar solution on the upper rack and then finish the cycle.
Dishwasher isn't filling with water (or "Check water supply" display occurs)	Water supply hose is kinked.	Install new supply hose (without kinks).
	Previous wash cycle was not completed or current wash cycle was interrupted.	Complete wash cycle or reset dishwasher.
	Delay start or Child lock may be activated.	Reset Delay start or Child lock functions (refer to the appropriate sections in this manual).
	Water supply line is clogged.	Unclog water line.
	Water supply was turned off.	Turn on water supply.



Fascia panel is discolored or scratched.	Panel was cleaned with bleach-based wipes or abrasive cleaners/cleaning pads.	Use mild detergents with soft damp cloth.
Noise from dishes rattling or water striking tub walls.	Dishes weren't loaded properly, allowing dishes to hit each other or spray arms.	Load dishes properly into racks. → <i>"Loading the Dishwasher"</i> on page 25
	Light dishes or lightly loaded racks allow dishes to move or water sprays to strike tubs.	Load more dishes or distribute dishes more evenly/securely in the dishwasher.
Water leaks from tub or from around door.	Suds from using the wrong detergent (i.e. dish) or overfilling/spilling rinse aid.	Use an appropriate dishwasher detergent, don't overfill rinse aid and clean any spilled rinse aid. If suds still persist, add one tablespoon of vegetable oil and run the desired cycle.
	Door seal was misaligned or pulled from its track.	Make sure the door seal is securely inserted into its track.
	Condensation vent is blocked.	Clean out vent and move tall items like trays away from the vent.
	Improper installation.	Have an authorized service professional remount the dishwasher.
White limes-cale on dishes, tub, racks or door.	White residue coats dishwasher interior and racks wheels squeak from lime scale deposits in hard water.	Use a dishwasher cleaner every few months. If dishwasher has a water softener, increase the setting.

	Hard water kept 3 in 1 detergent or Eco detergent from being effective.	Use separate dishwasher detergent, rinse aid and dishwasher softener salt (if dishwasher has a softener).
	Under dosing of detergent.	Use more detergent or change to a more effective detergent.
	Rinse temperature is too low.	Select more intensive wash cycles with higher washing temperatures.
Rust spots on stainless steel tub or door.	Rusting steel (e.g. cookie sheets), silverware or cast iron cookware allowed to rest against tub walls.	Clean stainless steel tub walls and make sure steel cookware and cutlery doesn't rest against tub walls. Wash cast iron cookware by hand.
	Bleach-based wipes or abrasive cleanser used to clean tub or door.	Use only mild detergents with a soft damp cloth to clean stainless steel tub and doors.
Rust spots on cutlery ("silverware") or steel cookware.	Cutlery isn't rust-resistant (e.g. knife blades) or is washed with rusting cutlery or cookware.	Use rust-resistant cutlery and cookware and don't wash rusting cutlery and cookware. Keep silverware and stainless steel cutlery separated.
	Salt content was too high due to salt dispenser cap not being fastened securely or salt was spilled during refilling*.	Fasten salt dispenser cap securely and remove spilled salt.*

Colored (blue, yellow, brown), film in the dishwasher or on stainless steel cutlery/ cookware.	Film from mixture of food and mineral deposits.	Can be partly removed with dishwasher cleaner or mechanical cleaning.
	Film formed by oxidation of silver or aluminum cookware.	Can be partly removed with dishwasher cleaner or mechanical cleaning.
Colored (yellow, orange, brown), easily removable film inside the dishwasher (mainly in the floor area)	Soapy film from mixture of food and hard water.	Use water softener* - refill with salt or increase setting where necessary. Use dishwasher detergent instead of a 3 in 1 or Eco detergent.
Plastic parts stained or discolored.	Water drops form on plastic surfaces and leave visible stains after drying.	Use more intensive wash cycles (which provide more water changes), arrange dishes in a sloping position and use rinse aid. If dishwasher has a water softener, increase softening setting.
	Plastic parts inside the dishwasher may become discolored over time.	Some plastics discolor normally, which is not due to the dishwasher.
	Rinse temperature is too low.	Select more intensive wash cycles with higher washing temperatures.
	Dishes pre-cleaned too well, so dishwasher defaults to a less intensive wash cycle and stubborn soiling isn't removed.	Do not pre-rinse dishes and remove only large food deposits.
Detergent residue in tub, detergent dispenser or detergent tab tray.	Detergent dispenser cover 33 was blocked by dishes and doesn't open fully.	Don't place dishes above the detergent tab tray 24 . Do not place dishes or fragrance dispenser in the detergent tab tray.

<p>Spray arms are blocked by dishes and detergent isn't rinsed out.</p>	<p>Make sure spray arms can rotate freely.</p>
<p>Detergent dispenser cover 24; blocked by the detergent tab.</p>	<p>Detergent tab must be inserted flat and not upright.</p>
<p>The detergent dispenser was damp when filled.</p>	<p>Make sure the detergent dispenser is dry before adding detergent.</p>
<p>Detergent tab used in the quick or short wash cycle. Dissolving time of the detergent is not reached in the selected short wash cycle.</p>	<p>When using quick or short wash cycles use a detergent powder or select a more intensive wash cycle.</p>
<p>Old detergents can be ineffective and not dissolve well.</p>	<p>Replace with fresh detergent.</p>



<p>Irreversible clouding of glassware.</p>	<p>Glassware not dishwasher-proof or water is too soft, causing minerals in glassware to change.</p>	<p>Use only dishwasher-proof glasses. Remove glasses promptly after cycle ends. Use lower temperature wash cycles. Set water softener according to water hardness or one setting lower. Use a detergent with glass protection. → <i>"Rinse Aid" on page 23</i></p>
<p>Tea or lipstick residue on dishes.</p>	<p>Selected wash cycle is too weak.</p>	<p>Select a more intensive wash cycle.</p>
	<p>Under dosing of detergent.</p>	<p>Use more detergent or change to a more effective detergent.</p>
	<p>Dishes pre-cleaned too well, so dishwasher defaults to a less intensive wash cycle and stubborn soiling isn't removed.</p>	<p>Do not pre-rinse dishes and remove only large food deposits.</p>
<p>Detergent dispenser cover will not shut</p>	<p>Cover guides are blocked by sticky detergent residue.</p>	<p>Remove detergent residue. → <i>"Detergent" on page 37</i></p>
<p>Unable to select desired cycle</p>	<p>Previous cycle not finished.</p>	<p>→ <i>"Operating the Dishwasher" on page 43</i></p>
<p>Touch sensitive keys not activating easily or activating without being touched</p>	<p>Water or other liquid on the surface.</p>	<p>Wiping the fascia with a wet cloth may cause unwanted activation. Wipe the fascia with a soft, dry cloth when possible. If you must use a damp cloth to clean, dry immediately. Never pour water on the controls.</p>



	Touch keys not being activated properly.	<p>Press the center of the touch key with the flat area of your fingertip. A beep will sound to indicate that the selection has been made. Touching the keys lightly should work.</p> <p>Note: There is a built-in delay to prevent someone from launching several actions at once by accidentally wiping their hand (or a cleaning cloth) across the control panel.</p>
*This is an optional feature which may or may not be included with your dishwasher.		

Warning

This content is compiled from multiple sources and is provided for reference purposes only. It may not be complete or fully applicable to all situations. If you are unable to resolve your issue, please contact the product manufacturer or an authorized service provider for official support.

