

## INSTALLATION INSTRUCTIONS

### Unpack the Refrigerator

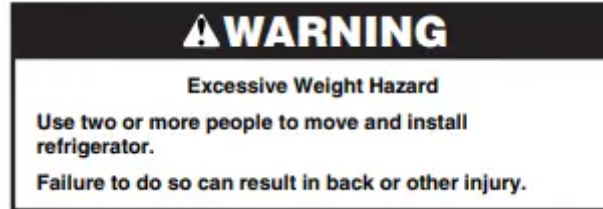

### Remove the Packaging

- Remove tape and glue residue from surfaces before turning on the refrigerator. Rub a small amount of liquid dish soap over the adhesive with your fingers. Wipe with warm water and dry.
- Do not use sharp instruments, rubbing alcohol, flammable fluids, or abrasive cleaners to remove tape or glue. These products can damage the surface of your refrigerator. For more information, see “Refrigerator Safety.”
- Dispose of/recycle all packaging materials.

**When Moving Your Refrigerator:** Your refrigerator is heavy. When moving the refrigerator for cleaning or service, be sure to cover the floor with cardboard or hardboard to avoid floor damage. Always pull the refrigerator straight out when moving it. Do not wiggle or “walk” the refrigerator when trying to move it, as floor damage could occur.

### Clean Before Using

After you remove all of the package materials, clean the inside of your refrigerator before using it. See the cleaning instructions in “Refrigerator Care.”

### Location Requirements

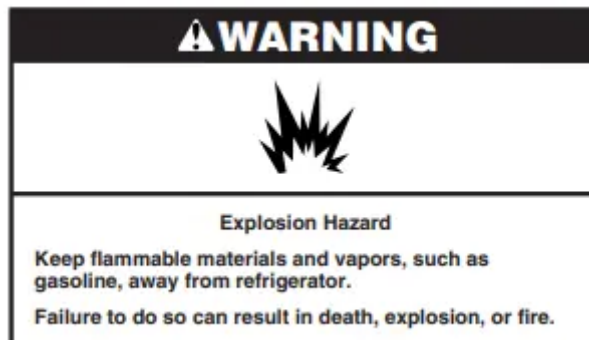

**IMPORTANT:** This refrigerator is designed for indoor, household use only. This appliance is intended to be used in household and similar applications such as:

- Staff kitchen areas in shops, offices and other working environments.
- Farm houses and by clients in hotels, motels and other residential type environments.
- Bed and breakfast type environments.
- Catering and similar non-retail applications.

To ensure proper ventilation for your refrigerator, allow for  $\frac{1}{2}$ " (1.25 cm) of space on each side and at the top. Allow for 1" (2.54 cm) of space behind the refrigerator. If your refrigerator has an ice maker, allow extra space at the back for the water line connections. When installing your refrigerator next to a fixed wall, leave  $2\frac{1}{2}$ " (6.3 cm) minimum on the hinge side (some models require more) to allow for the door to swing open.

**NOTE:** This refrigerator is intended for use in a location where the temperature ranges from a minimum of 55°F (13°C) to a maximum of 110°F (43°C). The preferred room temperature range for optimum performance, which reduces electricity usage and provides superior cooling, is between 60°F (15°C) and 90°F (32°C). It is recommended that you do not install the refrigerator near a heat source, such as an oven or radiator.

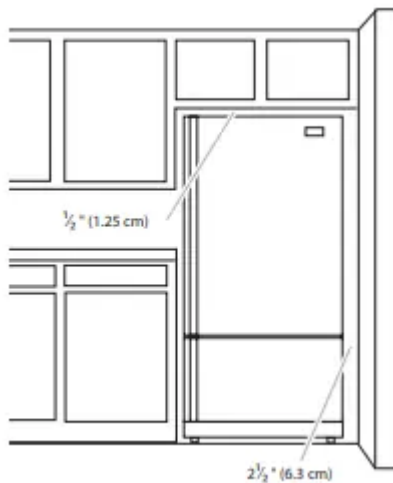

## Electrical Requirements

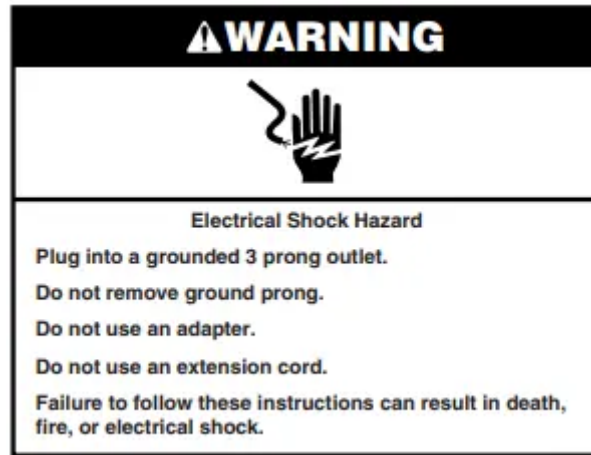

Before you move your refrigerator into its final location, it is important to make sure you have the proper electrical connection. If the supply cord is damaged, it must be replaced by the manufacturer or its service agent or a similarly qualified person. Do not use a cord that shows cracks or abrasion damage along its length or at either the plug or connector end.

### Recommended Grounding Method

A 115 Volt, 60 Hz, AC only 15 or 20 A fused, grounded electrical supply is required. It is recommended that a separate circuit serving only your refrigerator be provided. Use an outlet that cannot be turned off by a switch. Do not use an extension cord.

NOTE: Before performing any type of installation, cleaning, or removing a light bulb, turn the refrigerator to OFF. Depending on your model, either turn the freezer control to the word OFF, or press the Minus sign touch pads repeatedly until a dash (–) appears in both the Freezer and Refrigerator displays as shown. Disconnect the refrigerator from the electrical source. When you are finished, reconnect the refrigerator to the electrical source and reset the temperature controls to the desired setting. See “Using the Controls.”



## Water Supply Requirements

Gather the required tools and parts before starting installation. Read and follow the instructions provided with any tools listed here.

### TOOLS NEEDED:

- Flat-blade screwdriver
- ¼" Nut driver
- 7/16" and ½" Open-end or two adjustable wrenches

- ¼" Drill bit
- Cordless drill

**IMPORTANT:**

- Connect to a potable water supply only.
- All installations must meet local plumbing code requirements.
- Do not use a piercing-type or ⅜" (4.76 mm) saddle valve which reduces water flow and clogs more easily.
- Use copper tubing and check for leaks. Install copper tubing only in areas where the household temperatures will remain above freezing.
- For models with water filters, the disposable water filter should be replaced at least every 6 months.

**Water Pressure**

A cold water supply with water pressure of between 35 and 120 psi (241 and 827 kPa) is required to operate the water dispenser and ice maker. If you have questions about your water pressure, call a licensed, qualified plumber.

**Reverse Osmosis Water Supply**

**IMPORTANT:** The pressure of the water supply coming out of a reverse osmosis system going to the water inlet valve of the refrigerator needs to be between 35 and 120 psi (241 and 827 kPa).

If a reverse osmosis water filtration system is connected to your cold water supply, the water pressure to the reverse osmosis system needs to be a minimum of 40 to 60 psi (276 to 414 kPa). If the water pressure to the reverse osmosis system is less than 40 to 60 psi (276 to 414 kPa):

- Check to see whether the sediment filter in the reverse osmosis system is blocked. Replace the filter if necessary.
- Allow the storage tank on the reverse osmosis system to refill after heavy usage.
- If your refrigerator has a water filter, it may further reduce the water pressure when used in conjunction with a reverse osmosis system. Remove the water filter. See "Water Filtration System."

If you have questions about your water pressure, call a licensed, qualified plumber.

**Connect the Water Supply**

Read all directions before you begin.



**IMPORTANT:**

- Plumbing shall be installed in accordance with the International Plumbing Code and any local codes and ordinances.
- The gray water tubing on the back of the refrigerator (which is used to connect to the household water line) is a PEX (cross-linked polyethylene) tube. Copper and PEX tubing connections from the household water line to the refrigerator are acceptable, and will help avoid off-taste or odor in your ice or water. Check for leaks.
- If PEX tubing is used instead of copper, we recommend the following part numbers: W10505928RP (7 ft [2.14 m] jacketed PEX), 8212547RP (5 ft [1.52 m] PEX), or W10267701RP (25 ft [7.62 m] PEX).
- Install tubing only in areas where temperatures will remain above freezing.
- If you turn on the refrigerator before the water line is connected, turn off the ice maker to avoid excessive noise or damage to the water valve.

**Connect to Water Line**

1. Unplug refrigerator or disconnect power.
2. Turn OFF main water supply. Turn ON nearest faucet long enough to clear line of water.
3. Find a ½" to 1¼" (12.7 mm to 31.8 mm) vertical cold water pipe near the refrigerator.

**IMPORTANT:**

- Make sure it is a cold water pipe.
  - Horizontal pipe will work, but the following procedure must be followed: Drill on the top side of the pipe, not the bottom. This will help keep water away from the drill. This also keeps normal sediment from collecting in the valve.
4. Determine the length of copper tubing you need. Measure from the connection on the lower right rear of the refrigerator to the water pipe. Add 7 ft (2.1 m) to allow for cleaning. Use ¼" (6.35 mm) O.D. (outside diameter) copper tubing. Be sure both ends of copper tubing are cut square.
  5. Using a cordless drill, drill a ¼" hole in the cold water pipe you have selected.



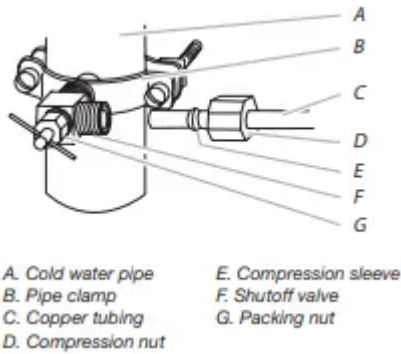

6. Fasten the shutoff valve to the cold water pipe with the pipe clamp. Be sure the outlet end is solidly in the ¼" drilled hole in the water pipe and that the washer is under the pipe clamp. Tighten the packing nut. Tighten the pipe clamp screws slowly and evenly so the washer makes a watertight seal. Do not overtighten.

7. Slip the compression sleeve and compression nut on the copper tubing as shown. Insert the end of the tubing into the outlet end squarely as far as it will go. Screw compression nut onto outlet end with adjustable wrench. Do not overtighten or you may crush the copper tubing.

8. Place the free end of the tubing in a container or sink, and turn ON the main water supply. Flush the tubing until water is clear. Turn OFF the shutoff valve on the water pipe.

### **Connect to Refrigerator**

Depending on your model, the water line may come down from the top or up from the bottom. Follow the connection instructions for your model.

#### **Style 1**

1. Remove plastic cap from water valve inlet port. Attach the copper tube to the valve inlet using a compression nut and sleeve as shown. Tighten the compression nut. Do not overtighten. Confirm copper tubing is secure by pulling on copper tubing.

2. Create a service loop with the copper tubing. Avoid kinks when coiling the copper tubing. Secure copper tubing to refrigerator cabinet with a "P" clamp.

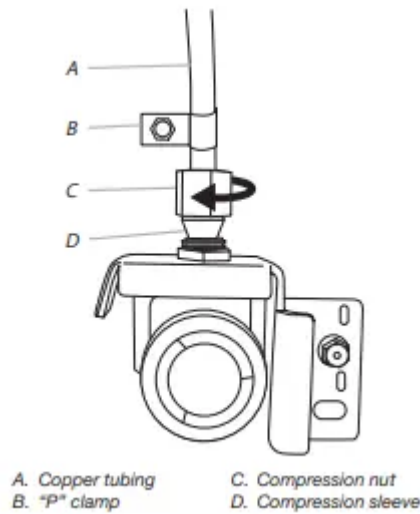

3. Turn on water supply to refrigerator and check for leaks. Correct any leaks.

### Style 2

1. Create a service loop (minimum diameter of 2 ft [61 cm]) with the copper tubing. Avoid kinks when coiling the copper tubing.
2. Remove the plastic cap from water valve inlet port. Place a compression nut and sleeve on the copper tubing.
3. Insert the end of the copper tubing into the water valve inlet port. Shape tubing slightly so that the tubing feeds straight into the port to avoid kinks.
4. Slide the compression nut over the sleeve and screw into the water valve inlet

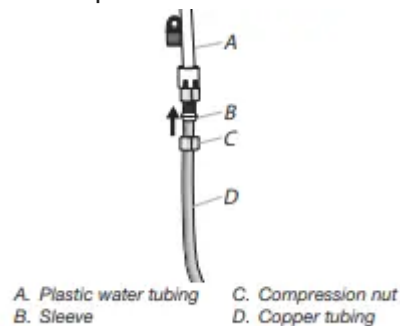

port.

5. Using an adjustable wrench, hold the nut on the plastic water line to keep it from moving. Then, with a second wrench turn the compression nut on the copper

tubing counterclockwise to completely tighten. Do not overtighten.

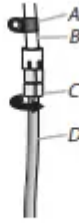

A. "P" clamp  
B. Plastic water line  
C. Compression nut  
D. Copper tubing

6. Check connection by pulling on copper tubing. Attach the plastic water line to the refrigerator cabinet with a "P" clamp.
7. Turn on water supply to the refrigerator and check for leaks. Correct any leaks.

### Complete the Installation

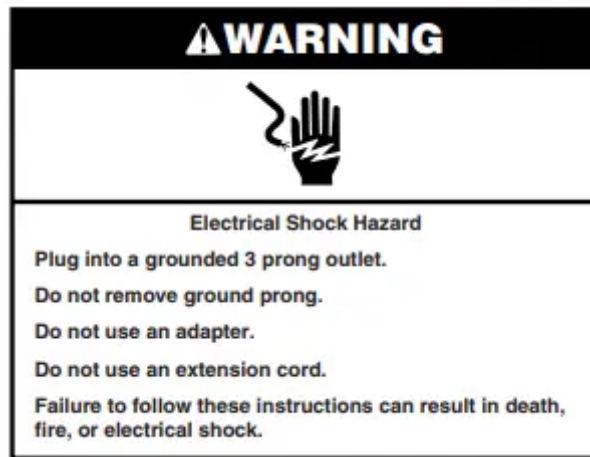

1. Plug into a grounded 3 prong outlet.

NOTE: Allow 24 hours to produce the first batch of ice. Discard the first three batches of ice produced. Allow 3 days to completely fill the ice storage bin.

### Refrigerator Door(s) and Drawer

TOOLS NEEDED: 5/16", 3/8", 1/4" hex head socket wrenches, a #2 Phillips screwdriver, and a flat-blade screwdriver.

IMPORTANT:

- Your refrigerator has a standard reversible refrigerator door with either a freezer door or freezer drawer, or French doors.
- Follow the instructions specific to the door style of your model.
- All graphics referenced in the following instructions are included later in this section after "Final Steps." The graphics shown for the standard door are for a right-hand swing refrigerator (hinges factory installed on the right).

- If you only want to remove and replace the doors see “Remove Doors and Hinges” and “Replace Doors and Hinges.”
- Before you begin, turn the refrigerator control OFF, and remove food and adjustable door or utility bins from the doors. Replace and Remove Handles.

## Replace and Remove Handles

### Standard Door

- To replace the handle, align the handle on the door or drawer as shown. Using a Phillips screwdriver, attach the handle with the handle screws.
- To replace the handle trim pieces, using your hand, apply firm pressure on the face of the trim and slide the trim piece toward the center of the handle.
- To remove handles, reverse directions.

### French Doors

- To remove the handle, use a  $\frac{3}{32}$ " hex key to loosen the two setscrews located on the side of each handle. Pull the handle straight out from the door or drawer. Make sure you keep the screws for reattaching the handles. See Handle graphics 1 and 2.
- To replace the handles, reverse the directions.

## Remove Doors and Hinges

### Standard Door



*Hex Head Top Hinge Screw*

### Freezer drawer models

1. Unplug refrigerator or disconnect power.
2. Keep the refrigerator door closed until you are ready to lift it free from the cabinet.
3. Remove the parts for the top hinge as shown in Top Hinge graphic. Lift the refrigerator door free from the cabinet.
4. Remove the parts for the bottom hinge as shown in Bottom Hinge graphic.

### Freezer door models

1. Unplug refrigerator or disconnect power.
2. Keep the freezer door closed until you are ready to lift it free from the cabinet.
3. Remove the parts for the top hinge as shown in Top Hinge graphic. Lift the refrigerator door free from the cabinet.

4. Remove the center hinge pin and remove the hinge screws as shown in the Center Hinge graphic. Lift the freezer door free from the cabinet.
5. Remove the base grille by grasping the grille firmly with both hands and pulling it toward you.
6. Remove the parts for the bottom hinge as shown in Bottom Hinge graphic.

## French Doors

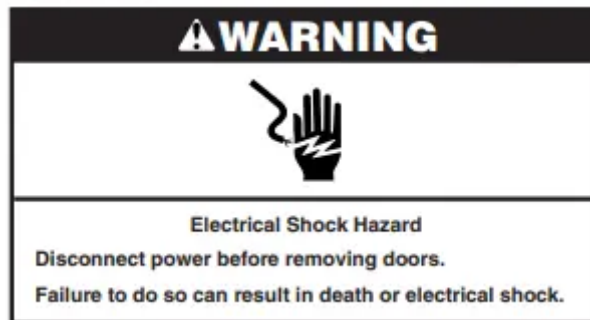

1. Unplug refrigerator or disconnect power.
2. Keep the refrigerator doors closed until you are ready to lift them free from the cabinet. NOTE: Provide additional support for the refrigerator door while the hinges are being removed. Do not depend on the door gasket magnets to hold the door in place while you are working.
3. Starting with the right-hand side door, remove the parts for the top hinge as shown in Top Hinge graphic. Lift the refrigerator door from the bottom hinge pin.
4. Remove the hinge pin cover from the bottom hinge pin and keep it for later use. See Bottom Hinge graphic.
5. Before removing the left-hand side door, disconnect the wiring plug located on top of the top hinge by wedging a flatblade screwdriver or your fingernail between the two sections. See Wiring Plug graphic. NOTE: The green, ground wire remains attached to the hinge.
6. Remove the parts for the left-hand side door top hinge as shown in the Top Hinge graphic. Lift the door from the bottom hinge pin.

NOTE: Remove the hinge pin cover from the bottom hinge pin and keep it for later use. See Bottom Hinge graphic.

## Reverse Door - Standard Door (optional)

IMPORTANT: If you want to reverse your door so it opens from the opposite side, follow these steps. If you are not reversing the door, see "Replace Door(s) and Hinges."

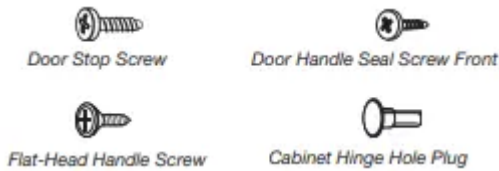

## Cabinet

1. Remove hinge screws from handle side and move them to opposite side. See Graphic 1.

## Refrigerator door

1. Remove the refrigerator handle assembly as shown in
2. Graphic 2. Keep all parts together.
3. Remove door handle seal screw front. Move to opposite side of refrigerator door as shown in Graphic 5.
4. Remove the door stop. Move it to the opposite side of the refrigerator door as shown in Graphic 3.
5. Attach refrigerator handle on opposite side of the refrigerator door with the two screws as shown in Graphic 2. Replace handle trim, as shown.
6. Tighten all screws. Set aside the door until hinges and freezer compartment drawer are in place.

## Freezer door

1. Remove the freezer handle assembly as shown in Graphic 4. Keep all parts together.
2. Remove door stop. Move to opposite side of freezer door as shown in Graphic 3.
3. Attach handle to opposite side of freezer door.
4. Tighten all screws. Set the door aside.
5. Remove the base grille by grasping the grille firmly with both hands and pulling it toward you. NOTE: Place a shim under the bottom front edge of the refrigerator cabinet to take the weight off the roller brackets.
6. Remove the screws from both roller brackets. See Graphic 6.
7. Remove the hinge plate located behind the roller bracket and move it to the opposite side of the refrigerator. Move the hinge pin and shim to the outside hole on the hinge plate. See Graphic 6.

## Replace Doors and Hinges

### Standard Door

NOTE: Graphics may be reversed if door swing is reversed.

### Freezer drawer models

1. Replace the parts for the bottom hinge as shown. Tighten screws. NOTE: Provide additional support for the door while the hinges are being moved. Do not depend on the door gasket magnets to hold the door in place while you are working.
2. Assemble the parts for the top hinge as shown in Top Hinge graphic. Do not tighten screws completely.
3. Adjust the door so that the bottom of the refrigerator door is aligned with the top of the freezer drawer. Tighten all screws.

### Freezer door models

1. Make sure the hinge plate is securely fastened behind the roller bracket and that the hinge pin is inserted into the outside hole. Fully tighten all roller bracket screws. See Graphic 6.
2. Remove the shim that you placed under the front edge of the refrigerator cabinet. Replace the freezer door. NOTE: Provide additional support for the door while the hinges are being moved. Do not depend on the door gasket magnets to hold the door in place while you are working.
3. Assemble the parts for the center hinge as shown in the Center Hinge graphic, and tighten all the screws. Replace the refrigerator door.
4. Assemble the parts for the top hinge as shown in the Top Hinge graphic. Do not tighten the screws completely.
5. Adjust the doors so that the bottom of the refrigerator door is aligned with the top of the freezer door. Tighten all screws.

### French Doors

1. Assemble the parts for the top hinges as shown in Top Hinge graphic. Do not tighten the screws completely.
2. Replace the parts for the bottom hinges as shown in Bottom Hinge graphic. Tighten screws. Replace the refrigerator doors. NOTE: Provide additional support for the refrigerator doors while the hinges are being moved. Do not depend on the door gasket magnets to hold the doors in place while you are working.
3. Align each door so that the bottom of the refrigerator door aligns evenly with the top of the freezer drawer. Tighten all screws.
4. Reconnect the wiring plug on top of the left-hand side refrigerator door.
5. Replace the top hinge covers.

### **Remove and Replace Freezer Drawer**

#### IMPORTANT:

- Two people may be required to remove and replace the freezer drawer.

- All graphics are included later in this section after “Final Steps.”

#### Remove Drawer Front

1. Open the freezer drawer to full extension.
2. Loosen the four screws attaching the drawer glides to the drawer front. See Drawer Front Removal graphic. NOTE: Loosen screws three to four turns. Keep the screws in the drawer front.
3. Lift drawer front upward and off the screws. See Drawer Front Removal graphic.

#### Replace Drawer Front

1. Slide the drawer glides out of the freezer compartment. Insert the screws in the top of the drawer front into the slots in the drawer brackets. See Drawer Front Replacement graphic.
2. Pull the drawer brackets toward you to insert the two screws in the bottom of the drawer front into the brackets. See Drawer Front Replacement graphic.
3. Completely tighten the four screws.

#### Final Steps

1. Check all holes to make sure that hole plugs and screws are in place. Reinstall top hinge cover as shown in Top Hinge graphic.
2. Replace the base grille.
3. Plug into a grounded 3 prong outlet.
4. Return all removable door parts to door and food to refrigerator

#### Standard Door - Freezer Door

## Door Removal & Replacement

### Top Hinge

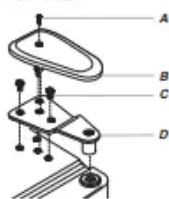

- A. Hinge Cover Screw
- B. Top Hinge Cover
- C.  $\frac{1}{2}$ " Hex-Head Hinge Screws
- D. Top Hinge

### Center Hinge

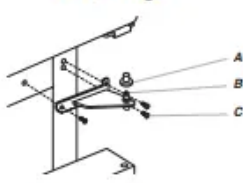

- A. Hinge Pin Cover
- B. Center Hinge
- C. Hinge Screws

### Bottom Hinge

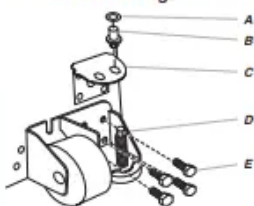

- A. Hinge Pin Shim
- B. Bottom Hinge
- C. Hinge Plate
- D. Roller Bracket
- E.  $\frac{3}{8}$ " Hex-Head Hinge Screws

## Door Swing Reversal (optional)

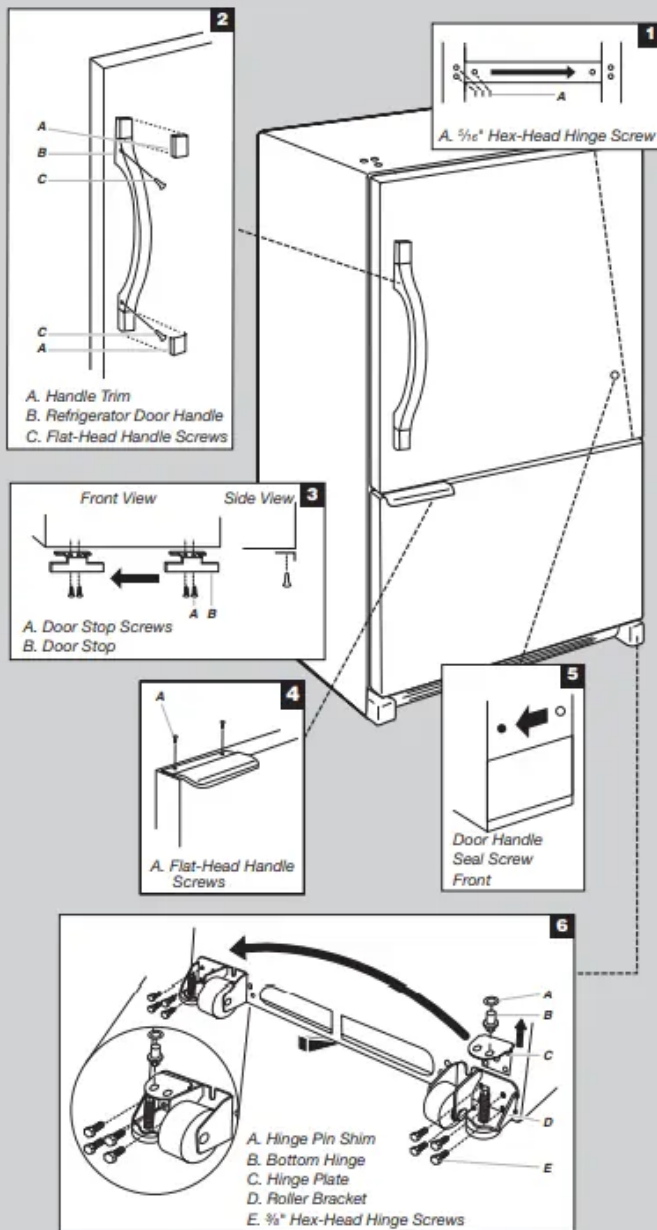

### Door Removal & Replacement

#### Top Hinge

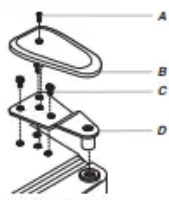

- A. Hinge Cover Screw
- B. Top Hinge Cover
- C. 3/16" Hex-Head Hinge Screws
- D. Top Hinge

#### Bottom Hinge

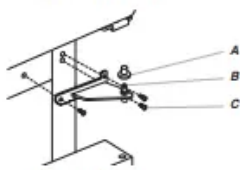

- A. Hinge Pin Cover
- B. Bottom Hinge
- C. Hinge Screws

### Door Swing Reversal (optional)

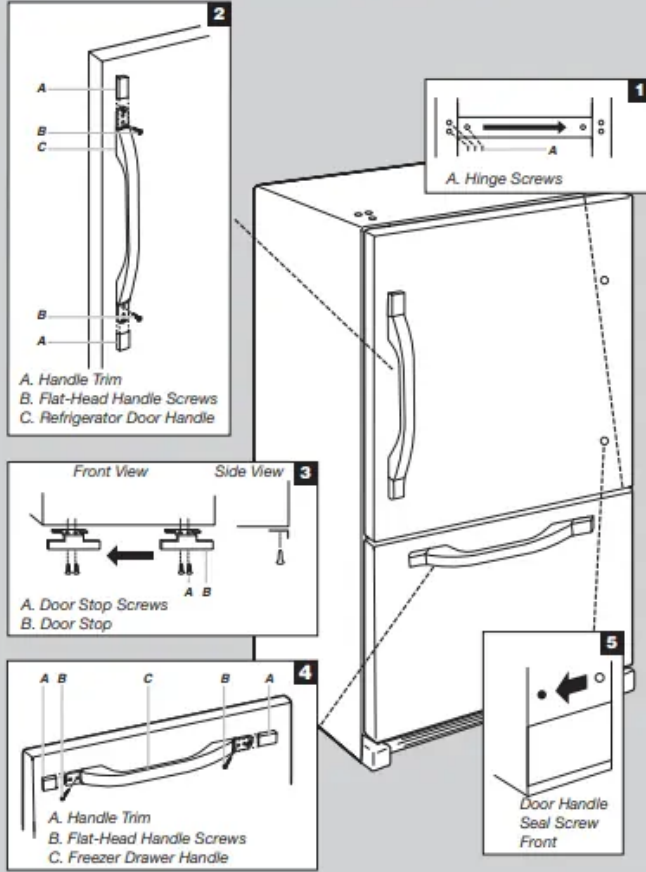

### Drawer Front Removal

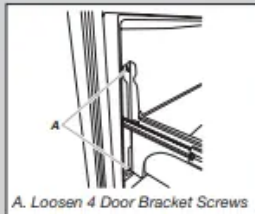

### Drawer Front Replacement

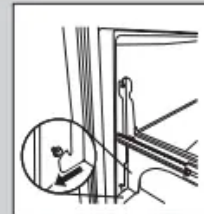
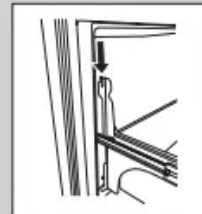
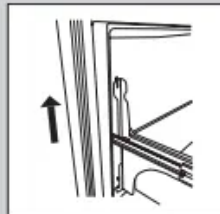

### French Doors





## ⚠ WARNING

Electrical Shock Hazard

Disconnect power before removing doors.

Failure to do so can result in death or electrical shock.

### Door Removal and Replacement

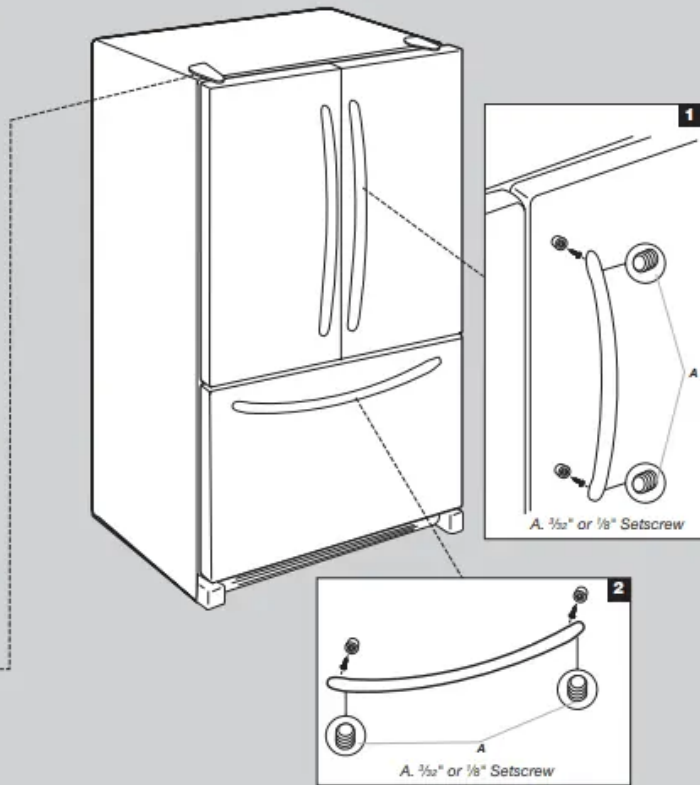
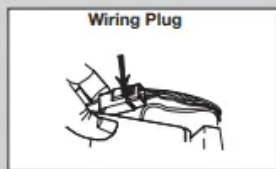
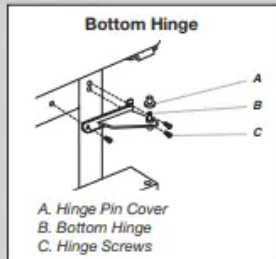
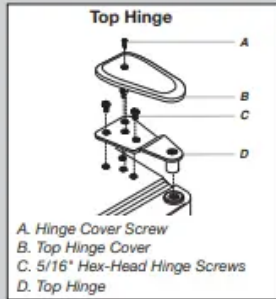

### Drawer Front Removal

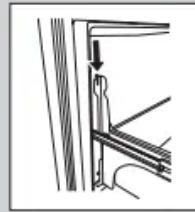
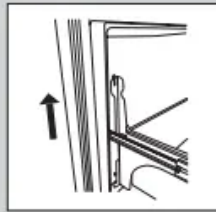
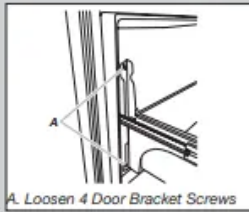

### Drawer Front Replacement

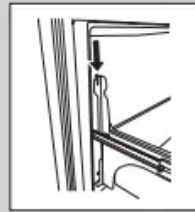
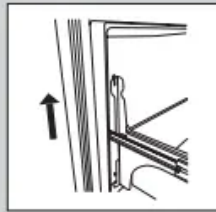
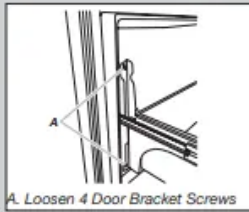

## Door Closing and Door Alignment

The base grille covers the leveling screws and roller assemblies located at the bottom of the refrigerator cabinet below the freezer door or drawer. Before making adjustments, remove the base grille and move the refrigerator to its final location.

1. Remove the two screws fastening the base grille to the cabinet, and set the screws aside. Grasp the grille and pull it toward you.

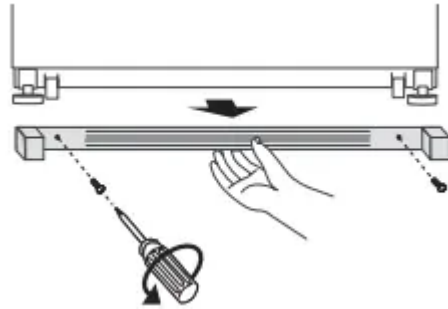

2. Move the refrigerator to its final location. NOTE: To allow the refrigerator to roll easier, raise the leveling legs off the floor by turning the leveling screws counterclockwise. The front rollers will be touching the floor.
3. So the doors will close easier, use a ¼" hex driver to turn both leveling screws clockwise. This will raise the front of the refrigerator tilting it slightly downward to the rear. Turn both leveling screws the same amount. NOTE: Having someone push against the top of the refrigerator takes some weight off the leveling screws.

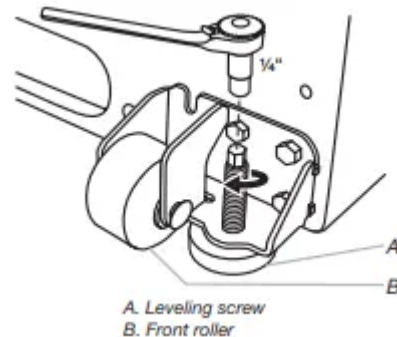

This makes it easier to turn the screws.

4. Open and close the doors to make sure they close as easily as you like. If not, increase the tilt by turning both leveling screws clockwise. It may take several turns of the leveling screw to allow the doors to close easier.
5. Check for door alignment. If one door is lower than the other, adjust the leveling screw, on the lower side of the refrigerator. Using a ¼" hex driver, turn the screw clockwise to raise that side of the refrigerator until the doors are aligned. It may take several turns of the leveling screw to raise the refrigerator. NOTE: Having

someone push against the top of the refrigerator takes some weight off the leveling

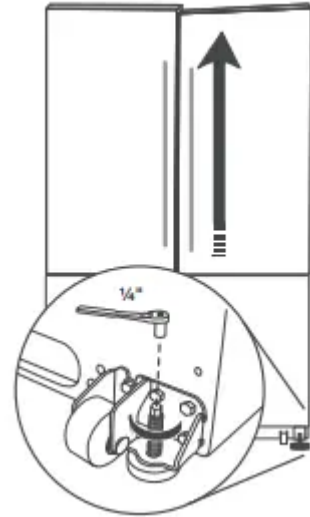

screws. This makes it easier to turn the screws.

6. Make sure the refrigerator is steady. If the refrigerator seems unsteady or rolls forward when the door or drawer is opened, adjust the leveling screws. Using a 1/4" hex driver, turn the leveling screw on each side clockwise until the rollers are up and the leveling feet are firmly against the floor.
7. Replace the base grille by aligning the holes in the grille with the holes in the cabinet and fasten using the screws removed in Step 1.

## REFRIGERATOR USE

### Opening and Closing Doors (French door models)

There are two refrigerator compartment doors. The doors can be opened and closed either separately or together.

There is a vertically-hinged seal on the left-hand refrigerator door.

- When the left-hand door is opened, the hinged seal automatically folds inward so that it is out of the way.
- When both doors are closed, the hinged seal automatically forms a seal between the two doors.

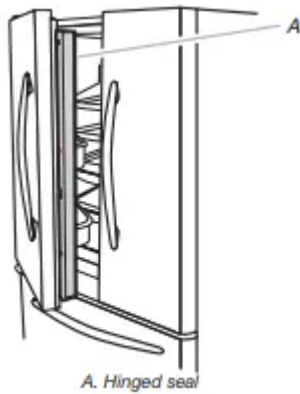

A. Hinged seal

## Using the Controls

The control center is located at the top front of the refrigerator compartment.

### Temperature Controls

For your convenience, your temperature controls are preset at the factory. When you first install your refrigerator, make sure the controls are still set to the recommended set points as shown.

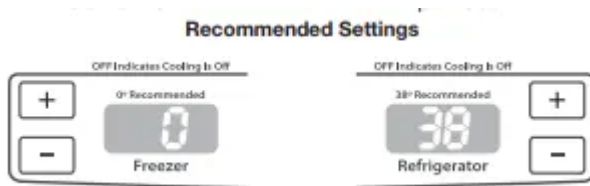

### IMPORTANT:

- The recommended settings should be correct for normal household refrigerator use. The controls are set correctly when milk or juice is as cold as you like and when ice cream is firm.
- When the power is on, the temperature display shows the set point temperature of the compartment.
- Wait 24 hours for your refrigerator to cool completely before adding food. If you add food before the refrigerator has cooled completely, your food may spoil.

NOTE: Adjusting the refrigerator and freezer temperature controls to a colder than recommended setting will not cool the compartments any faster.

- If the temperature is too warm or too cold in the refrigerator or freezer, first check the air vents to be sure they are not blocked before adjusting the controls.

### To Turn Your Refrigerator Off/On:

- Press the freezer (+) touch pad repeatedly until “OFF” appears in the freezer display. Allow a few seconds for the refrigerator to shut off. Neither compartment will cool.
- Press either the refrigerator or freezer (-) touch pad to turn on the refrigerator.

### Adjusting Controls

The REFRIGERATOR control adjusts the refrigerator compartment temperature. The FREEZER control adjusts the freezer compartment temperature.

If you need to adjust the temperature in either the refrigerator or freezer compartment, use the settings listed in the chart as a guide.

### To Adjust Set Point Temperatures:

The first touch of the (+) or (-) touch pad displays the current temperature set point.

- Press the (+) or (-) touch pads until the desired temperature set point is displayed.

NOTE: Except when first turning on the refrigerator, do not adjust either temperature control more than one setting at a time. Wait 24 hours between adjustments for the temperature to stabilize

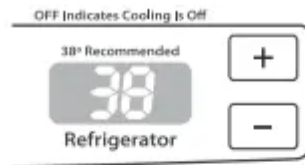

CONDITION/REASON:	ADJUSTMENT:
REFRIGERATOR too warm	REFRIGERATOR Control 1° lower
FREEZER too warm/too little ice	Adjust FREEZER Control 1° lower
REFRIGERATOR too cold	Adjust REFRIGERATOR Control 1° higher
FREEZER too cold	Adjust FREEZER Control 1° higher

### Additional Control Center Features

#### Max Ice

The Max Ice feature assists with temporary periods of heavy ice use by increasing ice production.

- Press the Max Ice feature touch pad to set the freezer to the lowest temperature setting. Press the Max Ice feature touch pad again to return to the normal freezer set point.

NOTE: The Max Ice feature will automatically shut off in approximately 24 hours.



## Humidity Control

The Humidity Control feature turns on a heater to help reduce moisture on the door hinge seal. Use in humid environments or when you notice moisture on the door hinge seal. The refrigerator uses more energy when Humidity Control is on.

- Press Humidity Control when the environment is warm and more humid, or if you notice moisture on the door hinge seal. The indicator light will be lit when humidity control is ON.
- Press Humidity Control to save energy when the environment is less humid.



## Temp Alarm

The Temp Alarm feature provides temperature information in the event of a power outage.

Power outage: During a power outage, if the temperatures in the refrigerator and freezer compartments exceed normal operating temperatures, the highest temperature reached will be displayed.

- Press the Temp Alarm touch pad until the indicator light is lit, to turn on this feature. Press and hold Temp Alarm for 3 seconds until the indicator light goes off to turn off this feature.

Temperature alarm: An alarm will sound repeatedly if the freezer or refrigerator compartment temperatures exceed normal operating temperatures for an hour or more.

The temperature displays will alternately show the current temperatures and the highest temperatures the compartments reached.

- Press the Temp Alarm touch pad once to stop the audible alarm and alternating temperature displays. The Temp Alarm light will continue to flash until the refrigerator returns to the set temperature.

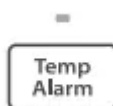

## Door Alarm

The Door Alarm feature sounds a chime every few seconds when the refrigerator door has been left open for 5 continuous minutes.

The chime will sound until the door is closed or Door Alarm is turned off.

- Press the Door Alarm touch pad to turn this feature on or off. The indicator light will be lit when the Door Alarm feature is on.



## Max Cool

The Max Cool feature assists with periods of high refrigerator use, full grocery loads, or temporarily warm room temperatures.

- Press Max Cool to set the freezer and refrigerator to the lowest temperature settings. Press Max Cool again to return to the normal refrigerator set point.

NOTE: The Max Cool feature will automatically shut off in approximately 12 hours.



## Filter Reset

The Filter Reset control allows you to restart the water filter status tracking feature each time you replace your water filter. See "Water Filtration System."

- Press and hold the Filter Reset touch pad for 3 seconds, until the Order or Replace light turns off.



## User Preferences

The control center allows you to set user preferences, if desired.

### Temperature Display (F\_C)

This preference allows you to change the temperature display.

F - Temperature in degrees Fahrenheit

C - Temperature in degrees Celsius

### Alarm (AL)

This preference allows you to turn off the sound of all alarms.

ON - You will hear the alarm sound.

OFF - You will not hear the alarm sound.

#### **To Access the User Preferences Menu:**

1. Press and hold the Door Alarm touch pad for 3 seconds. The preference name will appear in the Freezer display and the preference status (F or C) or (ON or OFF) will appear in the Refrigerator display.
2. Use the Freezer (+) or (-) touch pads to scroll through the preference names. When the desired preference name is displayed, press the Refrigerator (+) or (-) touch pads to change the preference status.
3. Set your preferences by pressing and holding the Door Alarm touch pad for 3 seconds, or by shutting the refrigerator compartment door.

### **Ice Maker**

**IMPORTANT:** Flush the water system before turning on the ice maker. See “Water Dispenser.”

#### **Turning the Ice Maker On/Off**

To turn the ice maker ON, simply lower the wire shutoff arm.

To manually turn the ice maker OFF, lift the wire shutoff arm to the OFF (arm up) position and listen for the click.

**NOTE:** Your ice maker has an automatic shutoff. As ice is made, the ice cubes will fill the ice storage bin and the ice cubes will raise the wire shutoff arm to the OFF (arm up) position. Do not force the wire shutoff arm up or down.

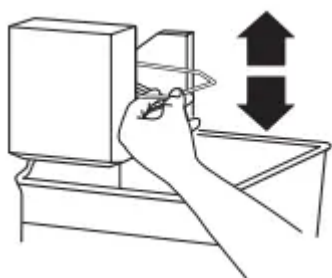

**NOTE:** Turn off the ice maker before removing the ice storage bin to serve ice or to clean the bin. This will keep the ice cubes from dropping out of the ice maker and into the freezer compartment. After replacing the ice storage bin, turn on the ice maker.

#### **Ice Production Rate**

- The ice maker should produce a complete batch of ice approximately every 3 hours.

- To increase ice production, lower the freezer and refrigerator temperature. See “Using the Controls.” Wait 24 hours between adjustments.

### **Remember**

- Allow 24 hours to produce the first batch of ice. Allow 3 days to completely fill the ice storage bin. Discard the first three batches of ice produced.
- The quality of your ice will be only as good as the quality of the water supplied to your ice maker. Avoid connecting the ice maker to a softened water supply. Water softener chemicals (such as salt) can damage parts of the ice maker and lead to poor quality ice. If a softened water supply cannot be avoided, make sure the water softener is operating properly and is well maintained.
- Do not store anything on top of the ice maker or in the ice storage bin.

### **Water Dispenser**

#### **IMPORTANT:**

- After connecting the refrigerator to a water source or replacing the water filter, flush the water system. Use a sturdy container to depress and hold the water dispenser lever for 5 seconds, then release it for 5 seconds. Repeat until water begins to flow. Once water begins to flow, continue depressing and releasing the dispenser lever (5 seconds on, 5 seconds off) until a total of 4 gal. (15 L) has been dispensed. This will flush air from the filter and water dispensing system, and prepare the water filter for use. Additional flushing may be required in some households. As air is cleared from the system, water may spurt out of the dispenser.

NOTE: After 5 minutes of continuous dispensing, the dispenser will stop dispensing water to avoid flooding. To continue dispensing, press the dispenser button again.

- Allow 24 hours for the refrigerator to cool down and chill water. Dispense enough water every week to maintain a fresh supply.

### **Dispensing Water**

1. Hold a container under the dispenser while pressing the button.
2. Release the button to stop dispensing.

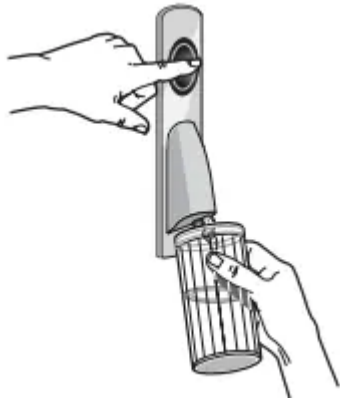

## **Water Filtration System**

The water filter is located in the upper right-hand corner of the refrigerator compartment.

**IMPORTANT:** The disposable water filter should be replaced at least every 6 months. If the water flow to the water dispenser or ice maker decreases noticeably before 6 months have passed, replace the water filter more often.

### **Replacing the Water Filter**

To purchase replacement water filters, model UKF8001AXX-750 or model UKF8001AXX-200, contact your dealer or call

U.S.A. or 1-800-807-6777 Canada.

**IMPORTANT:** Air trapped in the water system may cause water and filter to eject. Always dispense water for at least 2 minutes before removing the filter or blue bypass cap.

1. Turn filter counterclockwise to remove.
2. Remove sealing label from replacement filter and insert the filter end into the filter head.
3. Turn the filter clockwise until it stops. Snap the filter cover closed.
4. Flush the water system. See “Water and Ice Dispenser(s).”

**NOTE:** The dispenser feature may be used without a water filter installed. Your water will not be filtered. If this option is chosen, replace the filter with the blue bypass cap.

# REFRIGERATOR CARE

## Cleaning



Both the refrigerator and freezer sections defrost automatically. However, clean both sections about once a month to avoid buildup of odors. Wipe up spills immediately.

### IMPORTANT:

Because air circulates between both sections, any odors formed in one section will transfer to the other. You must thoroughly clean both sections to eliminate odors. To avoid odor transfer and drying out of food, wrap or cover foods tightly.

For stainless steel models, stainless steel is corrosion resistant and not corrosion-proof. To help avoid corrosion of your stainless steel, keep your surfaces clean by using the following cleaning instructions.

### To Clean Your Refrigerator:

NOTE: Do not use abrasive or harsh cleaners such as window sprays, scouring cleansers, flammable fluids, muriatic acid, cleaning waxes, concentrated detergents, bleaches or cleansers containing petroleum products on exterior surfaces (doors and cabinet), plastic parts, interior and door liners or gaskets. Do not use paper towels, scouring pads, or other harsh cleaning tools.

1. Unplug refrigerator or disconnect power.
2. Hand wash, rinse, and dry removable parts and interior surfaces thoroughly. Use a clean sponge or soft cloth and a mild detergent in warm water
3. Clean the exterior surfaces.

Painted metal: Wash painted metal exteriors with a clean, soft cloth or sponge and a mild detergent in warm water. Rinse surfaces with clean, warm water and dry immediately to avoid water spots.

Stainless steel: Wash stainless steel surfaces with a clean, soft cloth or sponge and a mild detergent in warm water. Rinse surfaces with clean, warm water and dry immediately to avoid water spots.

NOTE: When cleaning stainless steel, always wipe in the direction of the grain to avoid cross-grain scratching.

4. There is no need for routine condenser cleaning in normal home operating environments. If the environment is particularly greasy or dusty, or there is significant pet traffic in the home, the condenser should be cleaned every 2 to 3 months to ensure maximum efficiency.

If you need to clean the condenser:

- Remove the base grille.
- Use a vacuum cleaner with a soft brush to clean the grille, the open areas behind the grille and the front surface area of the condenser.
- Replace the base grille when finished.

5. Plug in refrigerator or reconnect power.

### Changing the Light Bulb

IMPORTANT: The light bulbs in both the refrigerator and freezer compartments of your new refrigerator use LED bulbs, incandescent bulb or a combination of the two. If the lights do not illuminate when the refrigerator and/or freezer door is opened, call for assistance or service. See “Warranty” for phone numbers.

1. Unplug the refrigerator or disconnect power.

2. Remove the light shield (on some models).

- Top of the refrigerator compartment - Slide the light shield toward the back of the compartment to release it from the light assembly.



3. Replace the burned-out bulb(s) with a bulb of the same size, shape and wattage.

- To replace the burned-out LED bulb with an LED bulb, order Part Number W10565137 (3.6 watts).

NOTE: Some LED replacement bulbs are not recommended for wet/damp environments. The refrigerator and freezer compartments are considered to be wet/damp environments. If using a brand of LED bulb other than the recommended LED bulb, before installation, read and follow all instructions on the LED packaging.

- When replacing an incandescent bulb, use only incandescent bulbs for household appliances with a maximum of 40 watts. Replace bulb shield/shroud after replacing incandescent bulb.

4. Replace the light shield.

5. Plug in refrigerator or reconnect power.

## **Vacation and Moving Care**

### **Vacations**

If You Choose to Leave the Refrigerator On While You're Away:

1. Use up any perishables and freeze other items.
2. If your refrigerator has an automatic ice maker, and is connected to the household water supply, turn off the water supply to the refrigerator. Property damage can occur if the water supply is not turned off.
3. If you have an automatic ice maker, turn off the ice maker. NOTE: Depending on your model, raise the wire shutoff arm to OFF (arm up) position, or press the switch to OFF.
4. Empty the ice bin.

Models with Vacation Mode Feature

- Turn on Vacation mode. See "Using the Controls."

NOTE: Activating Vacation mode does not turn off the ice maker.

If You Choose to Turn Off the Refrigerator Before You Leave:

1. Remove all food from the refrigerator.
2. If your refrigerator has an automatic ice maker:
  - Turn off the water supply to the ice maker at least one day ahead of time.
  - When the last load of ice drops, raise the wire shutoff arm to the OFF (up) position or press the switch to OFF, depending on your model.
3. Empty the ice bin.
4. Turn off the Temperature control(s). See "Using the Control(s)."
5. Clean refrigerator, wipe it, and dry well.
6. Tape rubber or wood blocks to the tops of both doors to prop them open far enough for air to get in. This stops odor and mold from building up.

### **Moving**

When you are moving your refrigerator to a new home, follow these steps to prepare it for the move.

1. If your refrigerator has an automatic ice maker:
  - Turn off the water supply to the ice maker at least one day ahead of time.
  - Disconnect the water line from the back of the refrigerator.

- When the last load of ice drops, raise the wire shutoff arm to the OFF (up) position or press the switch to OFF, depending on your model.
2. Remove all food from the refrigerator and pack all frozen food in dry ice.
  3. Empty the ice bin.
  4. Turn off the Temperature control(s). See “Using the Control(s).”
  5. Unplug refrigerator.
  6. Clean, wipe, and dry thoroughly
  7. Take out all removable parts, wrap them well, and tape them together so they don’t shift and rattle during the move.
  8. Depending on the model, raise the front of the refrigerator so it rolls more easily OR raise the leveling screws so they don’t scrape the floor. See “Adjust the Door(s)” or “Door Closing and Door Alignment.”
  9. Tape the doors closed and tape the power cord to the back of the refrigerator.

When you get to your new home, put everything back and refer to the “Installation Instructions” section for preparation instructions. Also, if your refrigerator has an automatic ice maker, remember to reconnect the water supply to the refrigerator.

## TROUBLESHOOTING

### Refrigerator Operation

The refrigerator will not operate

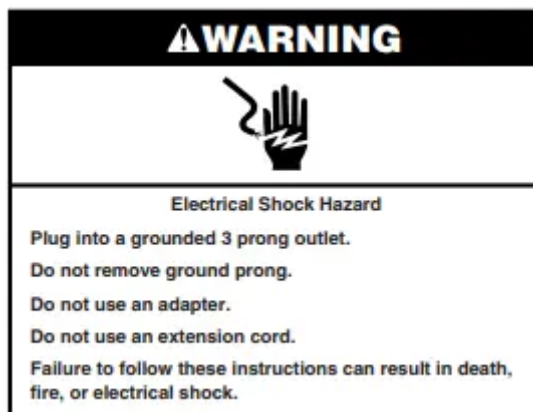

- Power cord unplugged? Plug into a grounded 3 prong outlet.
- Is outlet working? Plug in a lamp to see if the outlet is working.
- Household fuse blown or circuit breaker tripped? Replace the fuse or reset the circuit breaker. If the problem continues, call an electrician.

- Are controls on? Make sure the refrigerator controls are on. See “Using the Control(s).”
- New installation? Allow 24 hours following installation for the refrigerator to cool completely.

NOTE: Adjusting the temperature controls to coldest setting will not cool either compartment more quickly.

### **The motor seems to run too much**

Your new refrigerator may run longer than your old one due to its high-efficiency compressor and fans. The unit may run even longer if the room is warm, a large food load is added, doors are opened often, or if the doors have been left open.

### **The refrigerator seems noisy**

Refrigerator noise has been reduced over the years. Due to this reduction, you may hear intermittent noises from your new refrigerator that you did not notice from your old model. Below are listed some normal sounds with explanations.

- Buzzing - heard when the water valve opens to fill the ice maker
- Pulsating - fans/compressor adjusting to optimize performance
- Hissing/Rattling - flow of refrigerant, movement of water lines, or from items placed on top of the refrigerator
- Sizzling/Gurgling - water dripping on the heater during defrost cycle
- Popping - contraction/expansion of inside walls, especially during initial cool-down
- Water running - may be heard when ice melts during the defrost cycle and water runs into the drain pan
- Creaking/Cracking - occurs as ice is being ejected from the ice maker mold.

### **The doors will not close completely**

- Door blocked open? Move food packages away from door.
- Bin or shelf in the way? Push bin or shelf back in the correct position.

### **The doors are difficult to open**

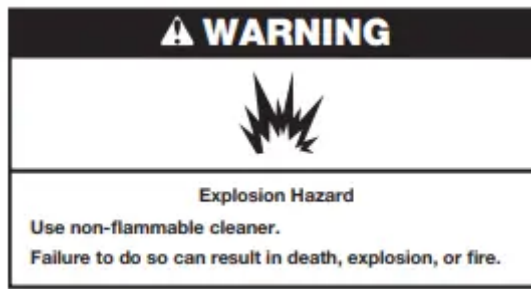

- Gaskets dirty or sticky? Clean gaskets and contact surfaces with mild soap and warm water. Rinse and dry with soft cloth.

## Temperature and Moisture

### Temperature is too warm

- New installation? Allow 24 hours following installation for the refrigerator to cool completely.
- Door(s) opened often or left open? Allows warm air to enter refrigerator. Minimize door openings and keep doors fully closed.
- Large load of food added? Allow several hours for refrigerator to return to normal temperature.
- Controls set correctly for the surrounding conditions? Adjust the controls a setting colder. Check temperature in 24 hours. See “Using the Control(s).”

### There is interior moisture buildup

NOTE: Some moisture buildup is normal.

- Humid room? Contributes to moisture buildup.
- Door(s) opened often or left open? Allows humid air to enter refrigerator. Minimize door openings and keep doors fully closed.

## Ice and Water

### The ice maker is not producing ice or not enough ice

- Refrigerator connected to a water supply and the supply shutoff valve turned on? Connect refrigerator to water supply and turn water shutoff valve fully open.
- Kink in the water source line? A kink in the line can reduce water flow. Straighten the water source line.
- Ice maker turned on? Make sure wire shutoff arm or switch (depending on model) is in the ON position.
- New installation? Wait 24 hours after ice maker installation for ice production to begin. Wait 72 hours for full ice production.

- Freezer door closed completely? Firmly close the freezer compartment door. If the freezer compartment door will not close all the way, see “The doors will not close completely,” earlier in this section.
- Large amount of ice recently removed? Allow 24 hours for ice maker to produce more ice.
- Ice cube jammed in the ice maker ejector arm? Remove ice from the ejector arm with a plastic utensil.
- Water filter installed on the refrigerator? Remove filter and operate ice maker. If ice volume improves, then the filter may be clogged or incorrectly installed. Replace filter or reinstall it correctly.
- Reverse osmosis water filtration system connected to your cold water supply? This can decrease water pressure. See “Water Supply Requirements.”

### **The ice cubes are hollow or small**

NOTE: This is an indication of low water pressure.

- Water shutoff valve not fully open? Turn the water shutoff valve fully open.
- Kink in the water source line? A kink in the line can reduce water flow. Straighten the water source line.
- Water filter installed on the refrigerator? Remove filter and operate ice maker. If ice quality improves, then the filter may be clogged or incorrectly installed. Replace filter or reinstall it correctly.
- Reverse osmosis water filtration system connected to your cold water supply? This can decrease water pressure. See “Water Supply Requirements.”
- Questions remain regarding water pressure? Call a licensed, qualified plumber.

### **Off-taste, odor or gray color in the ice**

- New plumbing connections? New plumbing connections can cause discolored or off-flavored ice.
- Ice stored too long? Discard ice. Wash ice bin. Allow 24 hours for ice maker to make new ice.
- Odor transfer from food? Use airtight, moisture proof packaging to store food.
- Are there minerals (such as sulfur) in the water? A water filter may need to be installed to remove the minerals.
- Water filter installed on the refrigerator? Gray or dark discoloration in ice indicates that the water filtration system needs additional flushing. Flush the water system before using a new water filter. Replace water filter when indicated. See “Water Filtration System.”

### **The water dispenser will not operate properly**

- Refrigerator connected to a water supply and the supply shutoff valve turned on? Connect refrigerator to water supply and turn water shutoff valve fully open.
- Kink in the water source line? Straighten the water source line.
- New installation? Flush and fill the water system. See “Water Dispenser.”
- Is the water pressure at least 35 psi (241 kPa)? The water pressure to the home determines the flow from the dispenser. See “Water Supply Requirements.”
- Water filter installed on the refrigerator? Remove filter and operate dispenser. If water flow increases, the filter may be clogged or incorrectly installed. Replace filter or reinstall it correctly.
- Refrigerator door closed completely? Close the door firmly. If it does not close completely, see “The doors will not close completely,” earlier in this section.
- Recently removed the doors? Make sure the water dispenser wire/tube assembly has been properly reconnected. See “Refrigerator Door(s) and Drawer.”
- Reverse osmosis water filtration system connected to your cold water supply? This can decrease water pressure. See “Water Supply Requirements.”

### **Water is leaking from the dispenser system**

NOTE: One or two drops of water after dispensing is normal.

- Glass not being held under the dispenser long enough?
- Hold the glass under the dispenser 2 to 3 seconds after releasing the dispenser lever.
- New installation? Flush the water system. See “Water Dispenser.”
- Recently changed water filter? Flush the water system.
- See “Water Dispenser.”
- Water on the floor near the base grille? Make sure the water dispenser tube connections are fully tightened. See “Refrigerator Door(s) and Drawer.”

### **Water from the dispenser is warm**

NOTE: Water from the dispenser is only chilled to 50°F (10°C).

- New installation? Allow 24 hours after installation for the water supply to cool completely.
- Recently dispensed large amount of water? Allow 24 hours for water supply to cool completely.
- Water not been recently dispensed? The first glass of water may not be cool. Discard the first glass of water.

- Refrigerator connected to a cold water pipe? Make sure the refrigerator is connected to a cold water pipe. See “Water Supply Requirements.”

**Warning**

This content is compiled from multiple sources and is provided for reference purposes only. It may not be complete or fully applicable to all situations. If you are unable to resolve your issue, please contact the product manufacturer or an authorized service provider for official support.

---

Document generated by [ManualsFile](#)