

## USING THE DISHWASHER

### Getting started

Features and appearance will vary throughout this manual

Match the control panel for your unit to a similar control panel below.

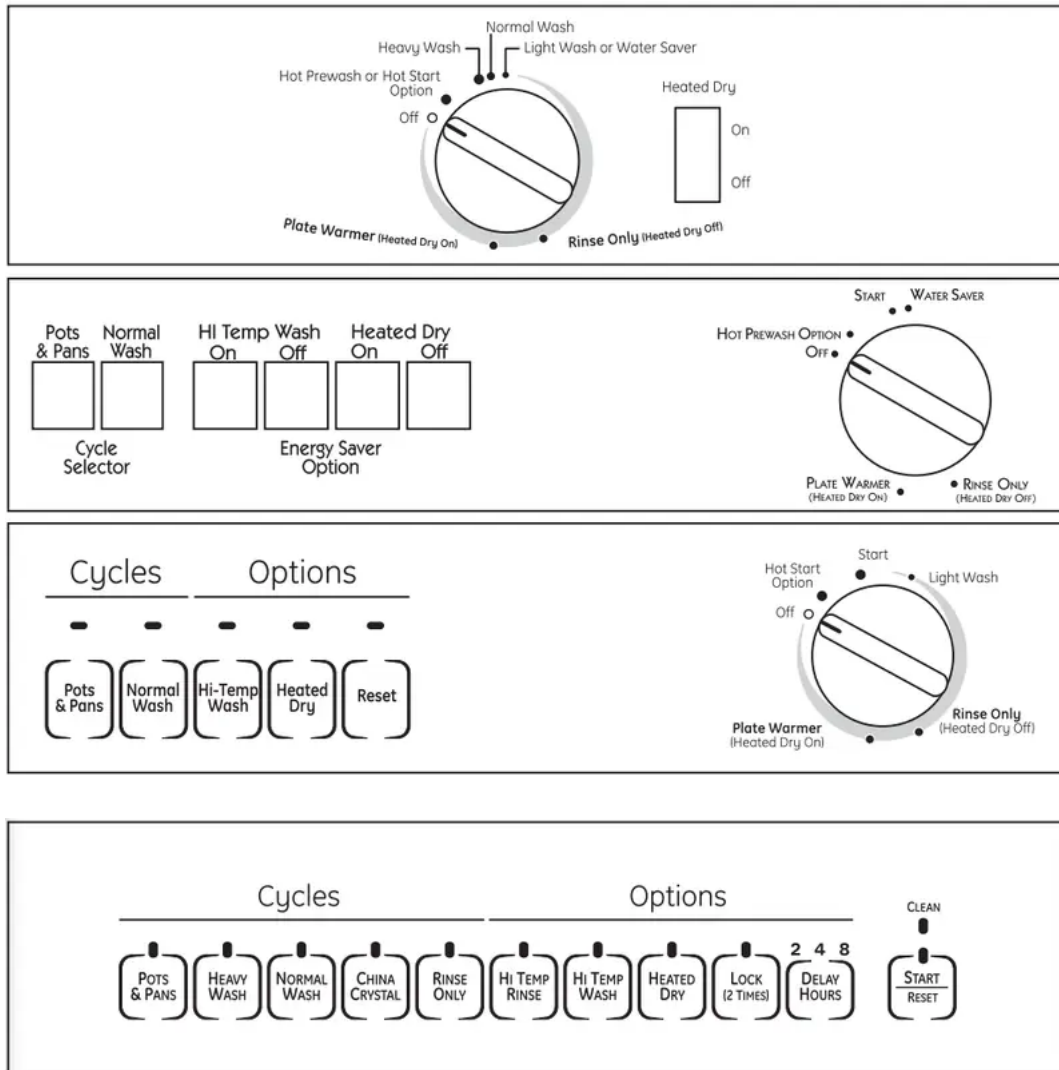

# 1

## Load Dishwasher

For best dishwashing results, follow the loading guidelines found in the Loading section. No pre-rinsing of normal food soil is required. Scrape off hard soils, including bones, toothpicks, skins, and seeds. Remove leafy vegetables, meat trimmings, and excessive amounts of grease or oil.



## 2 Add Detergent

Add needed amount of detergent to the detergent dispenser. Use detergent such as Finish® Quantum® Automatic Dishwashing Detergent. See Dispensers section.

## 3 Add Rinse Agent

Add rinse agent such as Finish® Jet-Dry® Rinse Aid to the rinse agent dispenser. See Dispensers section.

## 4 Select Cycle

On some models, an indicator light above the selected pad will be on to indicate which CYCLE has been selected.

**NOTE:** Actual cycle times vary based on soil level, water temperature, and options selected. Jet-Dry® Rinse Aid to the rinse agent dispenser. See Dispensers section.

<b>POTS &amp; PANS/ HEAVY WASH</b> (on some models)	For heavily soiled dishes or cookware with dried-on or baked-on soils. Everyday dishes may be included. This cycle will not remove burned-on foods.
<b>NORMAL/ NORMAL WASH</b>	This cycle is meant for daily, regular, or typical use to completely wash a full load of normally soiled dishes and is designed to conserve both water and energy.
<b>SHORT WASH</b> (on some models)	For quickly washing loads of everyday dishes with medium soils that have not dried on, such as loads consisting mostly of glasses.
<b>WATER SAVER/ LIGHT WASH</b> (on some models)	For dishes with light soils.
<b>RINSE ONLY</b>	For rinsing partial loads that will be washed later. <b>Do not use detergent.</b>
<b>DRYING/ PLATE WARMER</b> (on some models)	For warming clean dishes and serving plates. This cycle will take approximately 30 minutes.
<b>HOT PREWASH/ HOT START</b> (on some models)	Preheats wash water to the correct temperature.
<b>CHINA CRYSTAL</b> (on some models)	For lightly soiled china and crystal.

## Cycle Chart

Models	Cycle	Water Usage (gallons)	Cycle Time (minimum)
Timer Models	Hot Start Option <sup>1</sup>	2.5	10
	Heavy Wash	4.9 - 7.0	120
	Pots & Pans	6.0 - 7.0	118
	Normal Wash*	3.5 - 5.0	106
	Light Wash/Water Saver	3.9 - 5.5	114
	Rinse Only	2.2	58
	Plate Warmer/Drying	0.0	45
Electronic Models	Pots & Pans	8.8	121
	Heavy Wash	7.5	115
	Normal Wash	3.5	109
	China/Crystal	6.3	87
	Rinse Only	1.3	5

**Hot Start Option** adds water amount and cycle time shown when selected.

**Normal Wash** button should be pushed to run this cycle.

**NOTE:** Not all models have every cycle listed.

## 5 Select Options

On some models, an indicator light above the selected pad will be on to indicate which CYCLE has been selected.

**NOTE:** Actual cycle times vary based on soil level, water temperature, and options selected.

<b>HI TEMP RINSE</b> (on some models)	Turns on the heater in all final rinse cycles to help prevent spotting on dishware. This option may be turned <b>ON</b> or <b>OFF</b> during the wash cycle.
<b>HI TEMP WASH</b>	Energizes the heater to boost water temperature in prewash and main wash fill cycles. Recommended for use with heavily soiled dishes. Option may be turned <b>ON</b> or <b>OFF</b> during the wash cycle.
<b>HEATED DRY OFF</b>	Shuts off the drying heat option. Dishes air dry naturally and energy is saved. Open the dishwasher door to speed drying.
<b>HEATED DRY ON</b>	Turns the heater on for fast drying. This cycle will extend the time to your wash cycle by 30 minutes. <b>DO NOT</b> use with <b>RINSE ONLY</b> cycle.
<b>LOCK</b> (electronic models only)	When the <b>LOCK</b> pad is touched twice within 3 seconds, all pads become inoperative. You can lock the controls to prevent any selections from being made. Or you can lock the controls after you have started a cycle or selected <b>DELAY START</b> so the cycle or <b>DELAY START</b> is not interrupted. Children cannot accidentally start dishwasher by touching pads with this option selected. To unlock the dishwasher after it has been locked, touch the <b>LOCK</b> pad twice within 3 seconds. The light above the <b>LOCK</b> pad will turn off.
<b>DELAY HOURS</b> (on some models)	Delays the start of a wash cycle for up to 8 hours.
<b>RESET</b> (timer models only)	Touch <b>RESET</b> to cancel options.
<b>START/RESET</b> (electronic models only)	Touch <b>START/RESET</b> one time to start dishwasher cycle. Touch <b>START/RESET</b> a second time to pump out and then turn off the dishwasher. Do not touch <b>START/RESET</b> more than one time unless you intend to end the cycle.

## Starting the dishwasher - Models with a cycle dial

### Rinse Only

For rinsing partial loads that will be washed later. Do not use detergent.

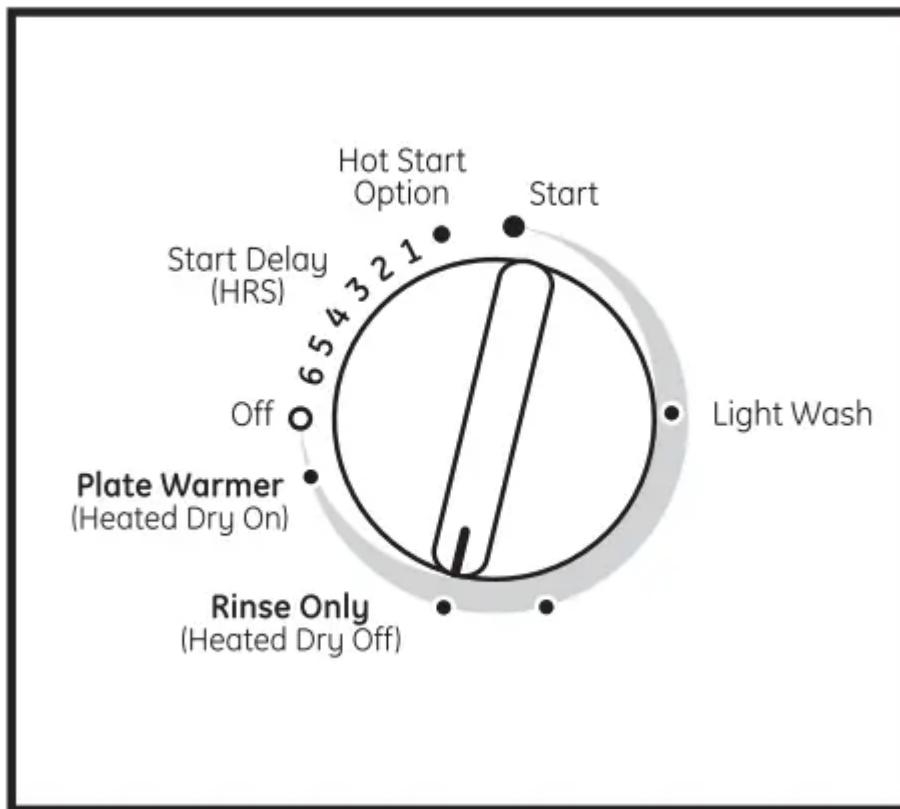

1. Make sure HEATED DRY is not selected.
2. Be sure the door is unlatched.
3. Slowly turn the dial to RINSE ONLY.
4. Latch the door to start the cycle.

### **Plate Warmer or Drying**

For warming clean dishes and serving plates. This cycle will take approximately 39 minutes.

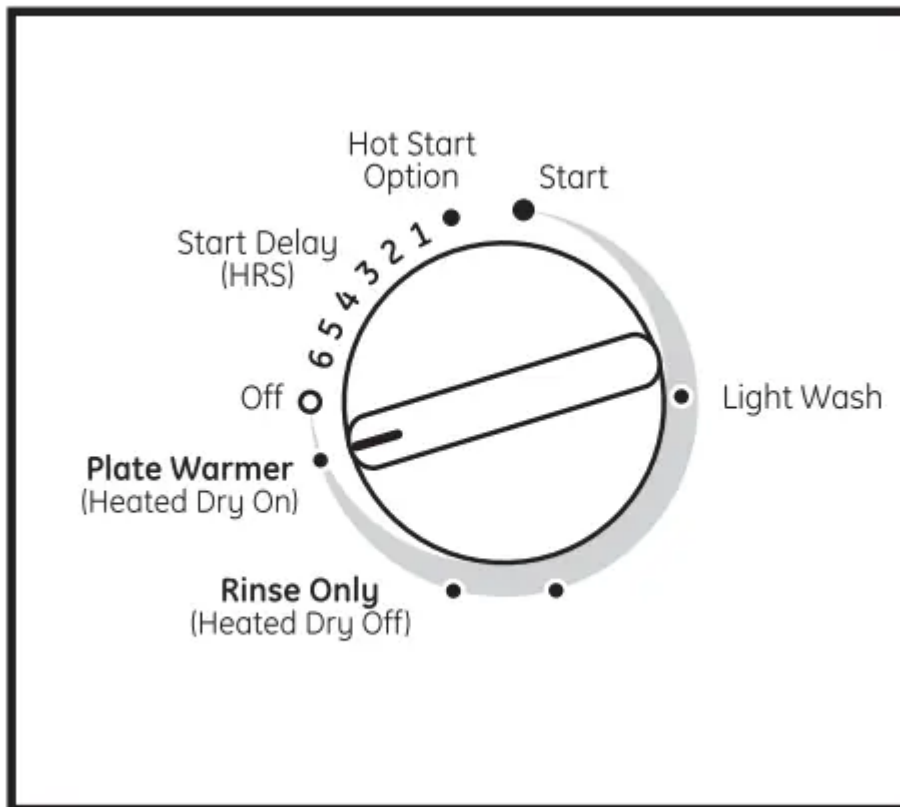

1. Load clean dishware to be warmed.
2. Select HEATED DRY ON.
3. Be sure the door is unlatched.
4. Slowly turn the dial to PLATE WARMER or DRYING.
5. Latch the door to start the cycle.

### **Hot Start or Hot Prestart Option**

Preheats wash water.

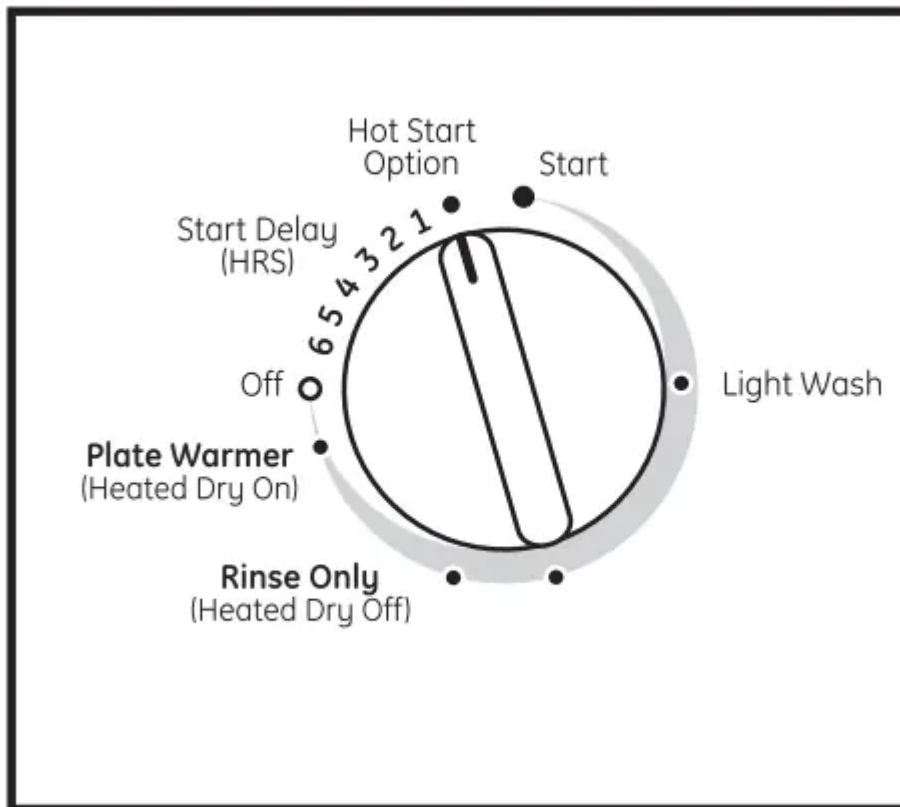

1. Select the HOT START or HOT PRESTART cycle and any other option on the push button pad.
2. Be sure the door is unlatched.
3. Slowly turn the dial to HOT START or HOT PRESTART.
4. Latch the door to start the cycle.

### **Short Wash or Light Wash or Water Saver**

For quickly washing loads of everyday dishes with light to medium soils that have not dried on.

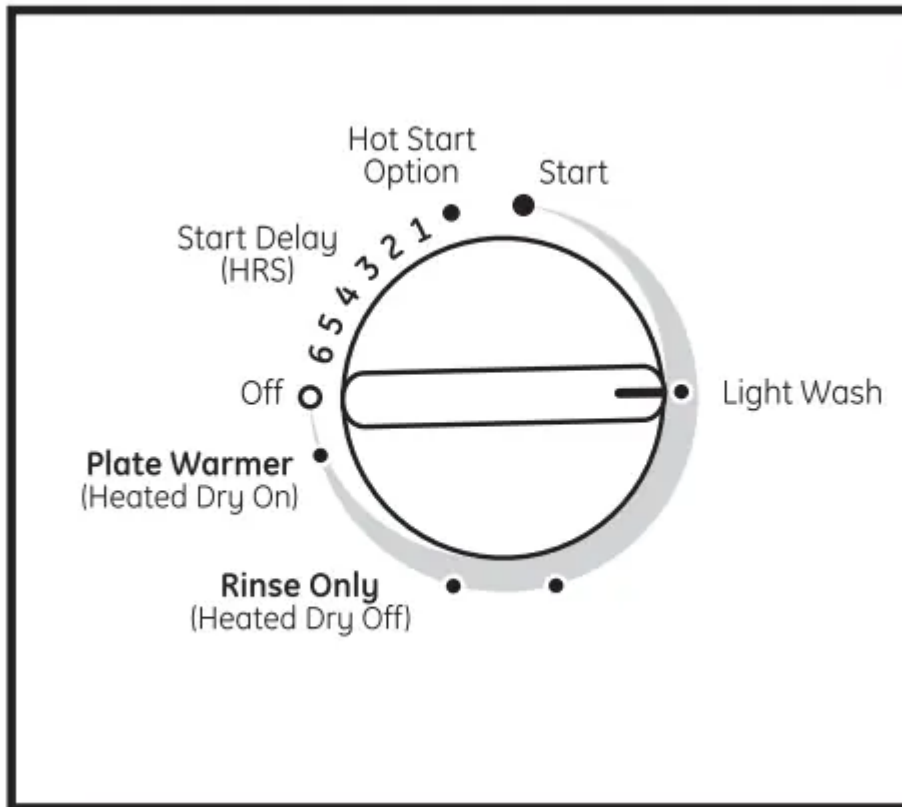

1. Be sure the door is unlatched.
2. Slowly turn the Dial to SHORT WASH, LIGHT WASH or WATER SAVER.
3. Latch the door to start the cycle.

**Start (Models with a Dial)**

Slowly turn the dial to the START or ON position, or the selected cycle. Don't turn it past the START, ON or cycle position; you could accidentally miss a prewash.

There is a time delay between start-up and water fill so you will not hear any wash action right away.

- Latch the door to begin the cycle.

**Starting the dishwasher - Model GSD4000 only**

**Start**

1. The door must be closed and locked into place to select a LOAD SELECTION or an OPTION.
2. If the door is opened during a cycle and left open, the dishwasher will beep once every 30 seconds until the door is closed and latched into place.

Close and latch the door. Touch the START/RESET pad to begin the cycle. Water fill begins and approximately 60 seconds later the wash action begins.



**NOTE:** The dishwasher remembers your last cycle so you don't have to reprogram each time. When the dishwasher is loaded and the door latch is in the locked position, the control panel lights will be on and display the last settings you selected.

If you don't want to change any of the settings, simply touch the START/RESET pad to begin the cycle.



Also, if a power failure occurs, NORMAL and HEATED DRY will automatically be programmed.

Make any new selections and touch the START/RESET pad to begin the cycle.

### Clean

This light is illuminated when a wash cycle is complete. The light will stay ON until the door is opened.

### Flashing Display Lights

Lights	What It Means	What to do
	This is normal. The START/RESET pad has been pressed.	Allow the dishwasher to drain and reset before you start a new wash cycle.
 Plus a beeping sound	Control Error	Press the START/RESET pad to turn off the beeper. If the CLEAN light continues to flash, call for service.
 Plus a beeping sound	Control Error	Press the START/RESET pad to turn off the beeper and the dishwasher will attempt to reset. Restart the wash cycle. If this error continues, turn off the power to the dishwasher at the circuit breaker for 30 seconds. Try the dishwasher again. If the error is still present, call for service.

### Dispensers

#### Check the Water Temperature

The entering water should be at least 120°F (49°C) and not more than 150°F (66°C) for effective cleaning and to prevent dish damage. Check the water temperature with a candy or meat thermometer.

Turn on the hot water faucet nearest the dishwasher, place the thermometer in a glass and let the water run continuously into the glass until the temperature stops rising.

Adjust the maximum/minimum temperature of the water heater if necessary to deliver water at the proper temperature.

#### Use a Rinse Agent

Rinse agents, such as Finish® Jet-Dry® Rinse Aid are designed for great drying action and to protect against spots and film build-up on your dishes, glasses, flatware, cookware, and plastic.

## Filling the Rinse Agent Dispenser

Fill the rinse agent dispenser until it reaches the bottom of lip inside the opening. Replace cap.

To check if rinse agent is needed, remove the cap and look into the dispenser.

A full dispenser should last about one month.

If the rinse agent spills, wipe up the excess.

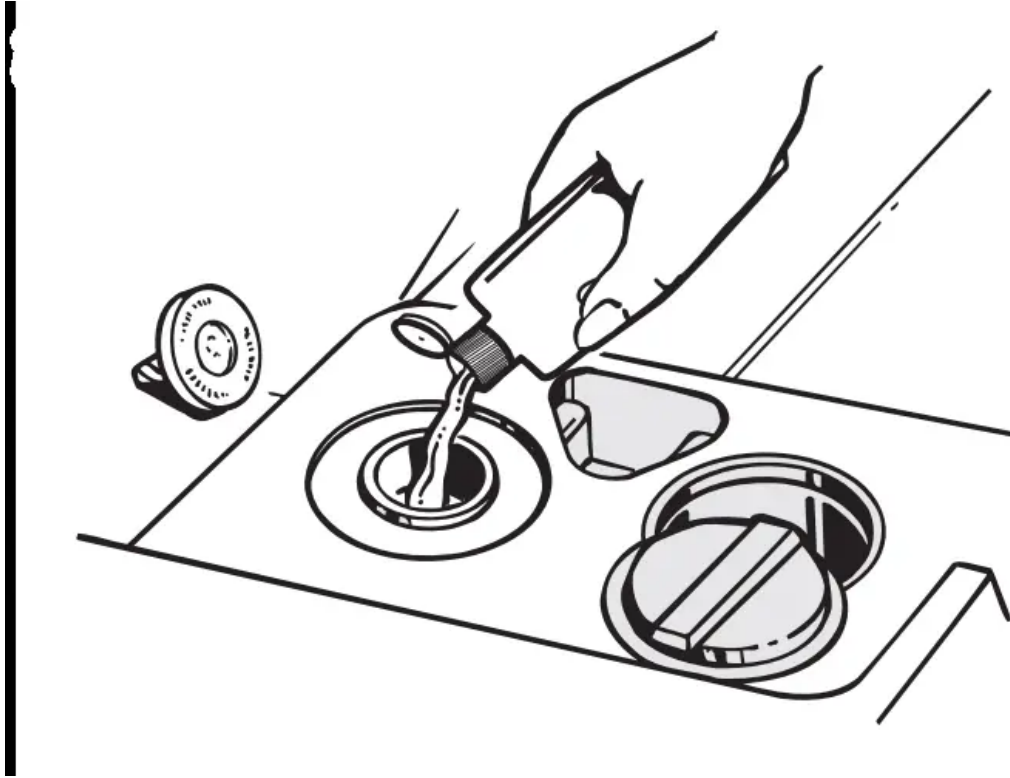

## Detergent Dispenser

Use only detergent specifically made for use in dishwashers. Finish® Quantum® Automatic Dishwashing Detergents have been approved for use in all GE Appliances dishwashers. Keep your detergent fresh and dry. Don't put powder detergent into the dispenser until you're ready to wash dishes.

The amount of detergent to use depends on whether your water is hard or soft. With hard water, you need extra detergent. With soft water, you need less detergent.

Protect your dishes and dishwasher by contacting your water department and asking how hard your water is.

Twelve or more grains is extremely hard water. A water softener is recommended. Without it, lime can build up in the water valve, which could stick while open and cause flooding.

You'll find two detergent dispensers on the inside door of your dishwasher. All wash cycles require detergent in the main cup. When using automatic dishwashing detergent tabs, such as Finish® Quantum® Powerball®, simply place one tab in the main cup and close.

Be sure the dial is OFF before adding detergent.

Otherwise, the detergent cup will not close and latch properly. Add detergent then close the main cup.



**NOTE:** To open detergent cup after it has been closed, simply turn the detergent cup handle counterclockwise until it releases. A snapping sound may be heard.

Use the table as a starting point and then adjust the amount of detergent you use. Use just enough to get good wash performance. Using just the right amount of detergent will provide great wash performance without wasting detergent or etching glassware.

Number of Grains/Gal.	Detergent Cup(s) to Fill
Less than 4	Fill cup to 1/3 full
4 to 8	Fill cup to 2/3 full
8 to 12	Fill cup completely full
Greater than 12	Fill both main wash cup and open cup

Using too much detergent with very soft and/or very hot water may cause a condition called etching on your glassware. Etching is a permanent cloudiness in your glassware. This condition is irreversible. However, using too little detergent will cause poor wash performance.

**DO NOT USE HAND DISH DETERGENT**

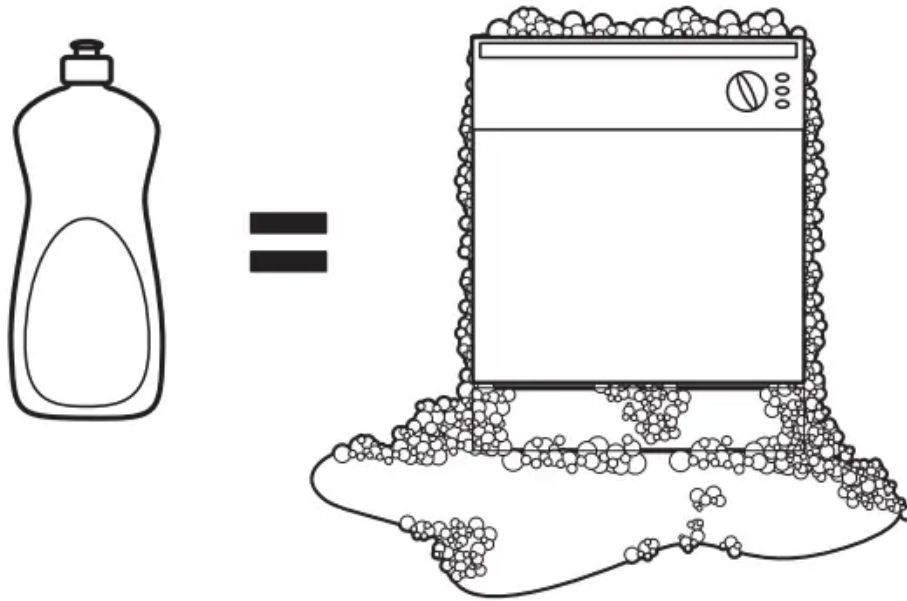

**NOTE:** Using a detergent that is not specifically designed for dishwashers will cause the dishwasher to fill with suds.

During operation, these suds will spill out of the dishwasher vents, covering the kitchen floor and making the floor wet.

Because so many detergent containers look alike, store the dishwasher detergent in a separate space from all other cleaners. Show anyone who may use the dishwasher the correct detergent and where it is stored.

While there will be no lasting damage to the dishwasher, your dishes will not get clean using a dishwashing detergent that is not formulated for automatic dishwashers.

## Loading

For best dishwashing results, follow these loading guidelines. Features and appearance of racks and silverware baskets may vary from your model.

### Upper Rack

The upper rack is for glasses, cups and saucers. Cups and glasses fit best along the sides. This is also a secure place for dishwasher-safe plastics. The upper rack is good for all kinds of odd-shaped utensils. Saucepans, mixing bowls and other items should be placed face down.

**Secure larger dishwasher-safe plastics over two fingers when possible.**

**Make sure small plastic items are secure so they can't fall onto the heating element.**

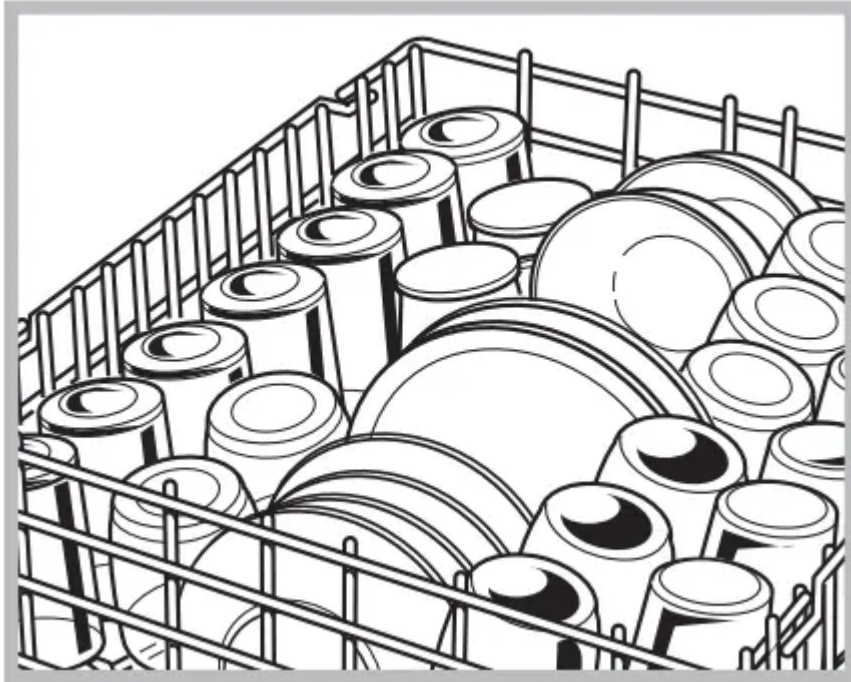

### **Lower Rack**

The lower rack is best used for plates, saucers and cookware. Large items such as broiler pans and racks should go along the sides. Load platters, pots and bowls along the sides, in corners or in the back.

The soiled side of items should face the center of the rack.

**When loading the lower rack, do not load large platters or trays in the front right corner. They may prevent detergent from circulating during the wash cycle.**



### Wash Tower

**Keep the center area clear in the lower rack.**

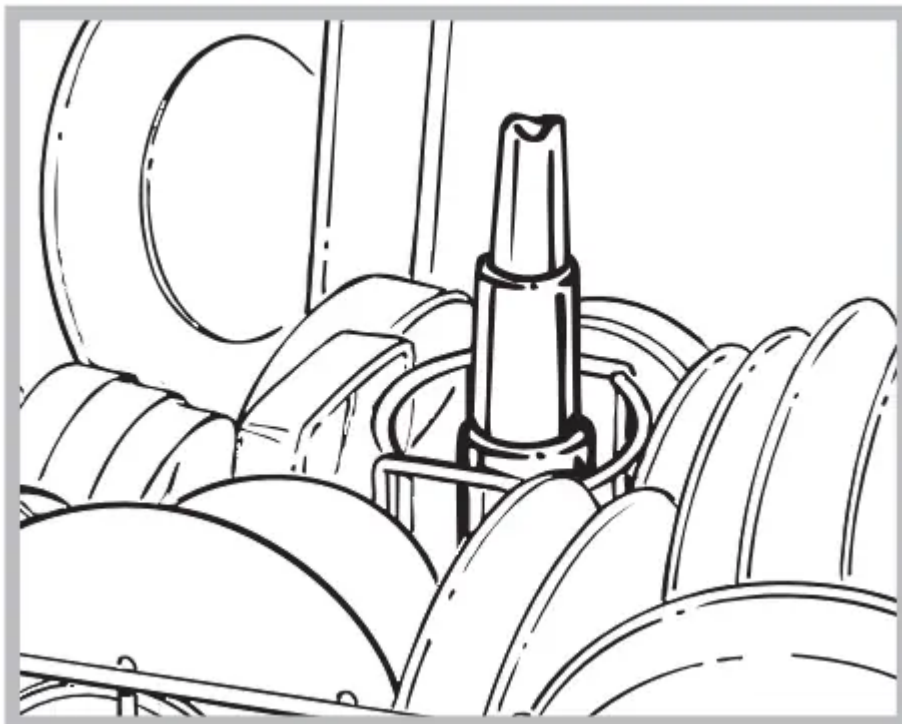

The wash tower rises through the center of the lower rack during the wash and rinse portions of the cycle.

**Don't block the wash tower or load tall things next to it.**



Be sure items don't fall through rack and block rotation of the spray arm.

Also, be careful not to let a portion of an item such as a pot or dish handle extend through the bottom rack. This could block the wash arm and cause poor washing results.

Don't block the upper rack wash tower.

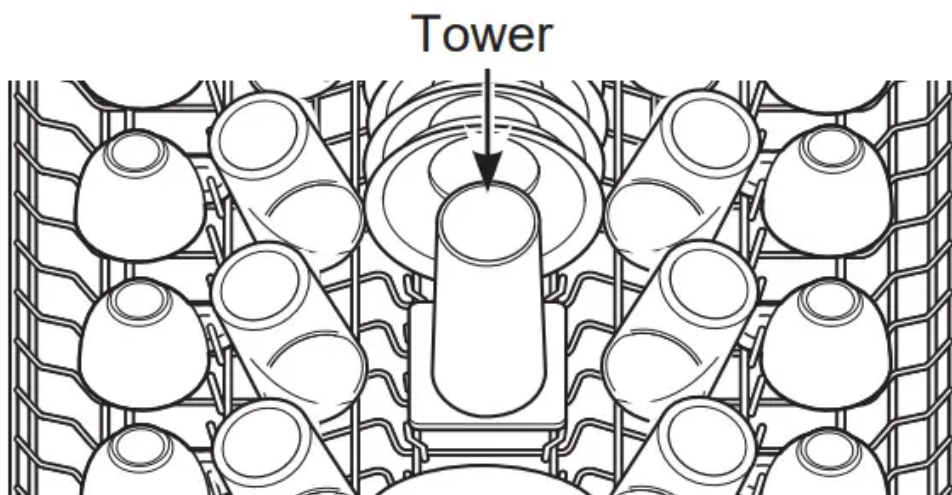

Do not cover upper rack tower (not present on all models)

**Silverware Basket**

Put flatware in the removable basket with fork and knife handles up to protect your hands. Place spoons in the basket with handles down. Mix knives, forks and spoons so they don't nest together.

Distribute evenly. Small plastic items, such as measuring spoons and lids from small containers, should go in the bottom of the silverware basket with silverware on top

**Don't let any item extend through bottom of silverware basket and rack, to ensure proper function of spray arm.**



For best dishwashing results, follow these loading guidelines. Features and appearance of racks and silverware baskets may vary from your model.

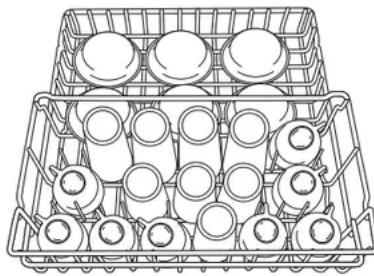

Upper Rack—8 place settings  
Undersink Models

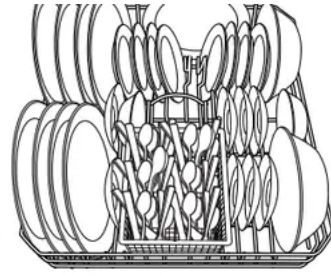

Lower Rack—8 place settings  
Undersink Models

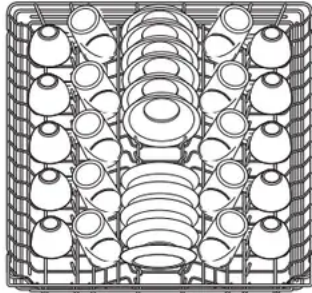

Upper Rack—10 place settings

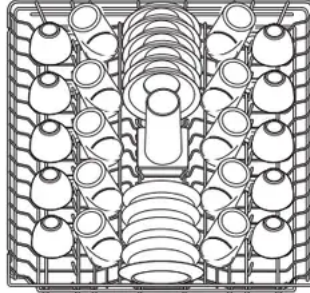

Upper Rack—10 place settings

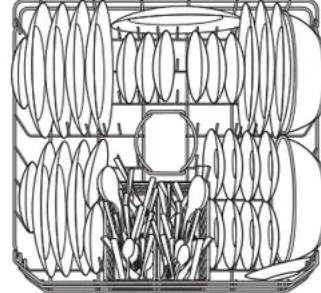

Lower Rack—10 place settings

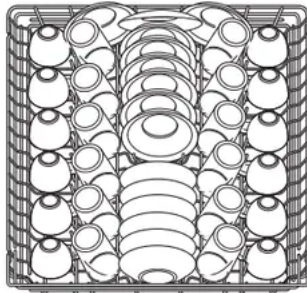

Upper Rack—12 place settings

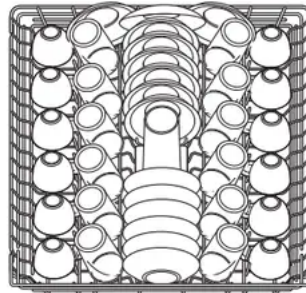

Upper Rack—12 place settings

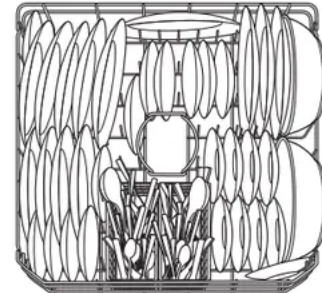

Lower Rack—12 place settings

## Forget to Add a Dish?

A forgotten dish can be added any time before the main wash.

1. Push the door latch to the left.
2. Once the water calms, open the door. Steam may rise out of the dishwasher.
3. Add forgotten dish.
4. Close the door and push the latch to the far

## Care and cleaning

### Control Panel

To clean the control panel, use a lightly dampened cloth.

Then dry thoroughly

### Exterior Door Panel

Use a clean, soft, lightly dampened cloth, then dry thoroughly.

Do not use scouring pads or powered cleaners because these products can scratch the finish.

### **Stainless Steel Door Panel**

For cleaning rust and tarnish, cleaners with oxalic acid such as Bar Keepers Friend Soft Cleanser™ will remove rust, tarnish and small blemishes. Use only a liquid cleanser free of grit and rub in the direction of the brush lines with a damp soft sponge. Do not use appliance wax or polish on the stainless steel.

For other blemishes and marks, use Stainless Steel Magic or a similar product using a clean soft cloth. Do not use appliance wax, polish, bleach or products containing chlorine on Stainless Steel. You can order Stainless Steel Magic # WX10X29 through GE Appliances Parts by calling 877.959.8688. In Canada, call 1-800-661-1616.

### **Dishwasher Interior**

To clean and de-odorize your dishwasher, use citric acid or Finish® Dishwasher Cleaner, a detergent additive. Finish® Dishwasher Cleaner will break up mineral deposits, and remove hard water film and stains.

You can order citric acid GE Appliances kit # WD35X151 through GE Appliances Parts by calling 877-959-8688. In Canada, call 1-800-661-1616. You can purchase Finish® Dishwasher Cleaner at your local grocery store.

### **Stainless Steel Inner Door and Tub**

The stainless steel used to make the dishwasher tub and inner door provides the highest reliability available in a GE Appliances dishwasher.

If the dishwasher tub or inner door should be scratched or dented during normal use, they will not rust or corrode. These surface blemishes will not affect their function or durability.

### **Protect Against Freezing**

If your dishwasher is left in an unheated place during the winter, ask a service technician to:

1. Turn off electrical power to the dishwasher. Remove fuses or trip circuit breaker.
2. Turn off the water supply and disconnect the water inlet line from the water valve.
3. Drain water from the water inlet line and water valve. (Use a pan to catch the water.)
4. Reconnect the water inlet line to the water valve.

5. Remove the plastic sump cover in the tub bottom and use a sponge to soak up water in the rubber boot

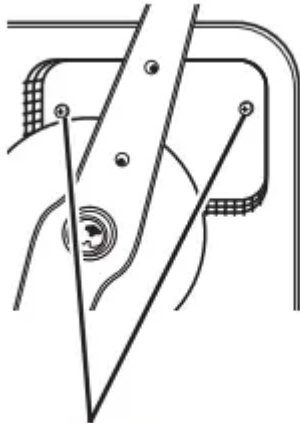

Sump cover screws

### Does Your Dishwasher Have an Air Gap?

An air gap protects your dishwasher against water backing up into it if a drain clogs. The air gap is not a part of the dishwasher. It is not covered by your warranty. Not all plumbing codes require air gaps, so you may not have one. The air gap is easy to clean.

## Air gap



Check the air gap any time your dishwasher isn't draining well.

1. Turn off the dishwasher and lift off the air gap cover.
2. Remove the plastic cap under the cover and clean with a toothpick.
3. Replace the cap and cover when the air gap is clean.

### Troubleshooting Tips...

Before you call for service

<b>Problem</b>	<b>Possible Cause</b>	<b>What To Do</b>
<b>Dishes and flatware not clean</b>	<b>Low inlet water temperature</b>	Raise the water heater temperature to 120°F. Use HOT START, POTS & PANS or HEAVY WASH and HI TEMP WASH.
	<b>Poor performing detergent</b>	Use a highly rated detergent such as Finish® Quantum® Automatic Dishwashing Detergent.
	<b>Old or damp powdered detergent</b>	See USING THE DISHWASHER section, refer to Detergent Dispenser for detergent recommendations.
	<b>Water pressure is temporarily low</b>	Turn on a faucet. Is water coming out more slowly than usual?  If so, wait until pressure is normal before using your dishwasher.  Normal water pressure to the dishwasher should be 20-120 psi.
	<b>Air gap or disposer clogged</b>	Clean the air gap or flush the disposer.
	<b>Improper rack loading</b>	Make sure large dishware does not block the detergent dispenser or the wash arm. See the Loading section.
	<b>High drain loop or air gap not installed</b>	Refer to the Installation Instructions for proper drain line installation.

<b>Spots and filming on glasses and flatware</b>	<b>Extremely hard water</b>	Use rinse agents such as Finish® Jet-Dry® Rinse Aid to prevent spots and prevent new film build-up.  If water is extremely hard, a softener may be required.
	<b>Low inlet water temperature</b>	Make sure water temperature is at least 120°F (49°C).
	<b>Overloading or improper loading of the dishwasher</b>	Load dishwasher as shown in the Loading section.
	<b>Old or damp powder detergent</b>	Make sure detergent is fresh. Use a highly rated detergent such as Finish® Quantum® Automatic Dishwashing Detergent.
	<b>Rinse agent dispenser empty</b>	Refill with rinse agent such as Finish® Jet-Dry® Rinse Aid.
	<b>Too little or low performing detergent</b>	Make sure you use the proper amount of highly rated detergent.
<b>Cloudiness on glassware</b>	<b>Combination of soft water and too much detergent</b>	This is called etching and is permanent. To prevent this from happening, use less detergent if you have soft water.
	<b>Low performing phosphatefree detergent</b>	See A white film on glassware, dishware and the interior in this TROUBLESHOOTING section.

	<p><b>Water temperature entering dishwasher exceeds 150°F</b></p>	<p>This could be etching. Lower the water heater temperature.</p>
<p>A white film on glassware, dishware and the interior</p>	<p><b>This problem is likely caused by a low quality phosphate-free dishwasher detergent</b></p>	<p>To remove the white film, run your dishes through a dishwasher cycle with citric acid. Use a WD35X151 citric acid kit found online. Otherwise, use Finish® Dishwasher Cleaner found at your local grocery store. Pour the citric acid in the detergent cup and close the cover. Place the filmed but otherwise clean glassware and dishware in the dishwasher. Leave silverware and other metal items out of the dishwasher. Turn the dishwasher on and let it run through a complete cycle without detergent. The glassware, dishware, and dishwasher should come out film free. Alternatively, a vinegar rinse may be used. Pour 1 cup of vinegar into dishwasher just after the detergent cup opens and let the dishwasher complete its cycle. This may be repeated several times a year as needed. The use of a rinse agent such as Finish® Jet-Dry® Rinse Aid may help minimize a repeat build up of film. Also, the use of a highly rated detergent such as Finish® Quantum® Automatic Dishwashing</p>



		Detergent will help prevent film build-up.
<b>Suds in the tub</b>	<b>Wrong detergent</b>	Use only automatic dishwasher detergents to avoid sudsing. Finish® Quantum® Automatic Dishwashing Detergent has been approved for use in all GE Appliances dishwashers. To remove suds from the tub, open the dishwasher and let suds dissipate. Add 1 gallon of cold water to the tub. On Models with a dial: Close and latch the dishwasher. Pump out water by slowly turning the dial until a drain period is reached. Repeat if necessary. On Models with Electronic Control: Pump out water by pressing the START/RESET pad, then 10 seconds later, press START/RESET pad again. Repeat if necessary.
	<b>Rinse agent was spilled</b>	Always wipe up rinse agent spills immediately
<b>Detergent cup lid won't latch</b>	<b>Dial is not in the OFF position</b>	Turn the timer dial to OFF.
<b>Detergent left in dispenser cups</b>	<b>Dishes or utensils are blocking the detergent cup</b>	Reposition the dishes. See the Loading section.
<b>Black or gray marks on dishes</b>	<b>Aluminum utensils have rubbed against dishes</b>	Remove marks with a mild, abrasive cleaner.
<b>Dishes don't dry</b>	<b>Low inlet water temperature</b>	Make sure inlet water temperature is at least 120°F. Select HEATED



		<p>DRY. Use HOT START and ADDED HEAT options. Select a higher cycle, such as POTS &amp; PANS or HEAVY WASH.</p>
	<b>Rinse agent dispenser is empty</b>	<p>Check the rinse agent dispenser and fill as required.</p>
<b>Control panel responded to inputs but dishwasher never filled with water</b>	<b>Door latch may not be properly seated</b>	<p>Call for service.</p>
	<b>Water valve may be turned off</b>	<p>Make sure water valve (usually located under the sink) is turned on.</p>
<b>Stained tub interior</b>	<b>Some tomato-based foods can cause reddish stains</b>	<p>Use of the RINSE ONLY cycle after adding the dish to the load can decrease the level of staining.</p>
	<b>Tea or coffee stains</b>	<p>Remove the stain by hand, using a solution of 1/2 cup bleach and 3 cups warm water.</p> <p><b>CAUTION</b> Before cleaning interior, wait at least 20 minutes after a cycle for the heating elements to cool down. Failure to do so can result in burns.</p>
	<b>An overall yellow or brown film can be caused by iron deposits in water</b>	<p>A special filter in the water supply line is the only way to correct this problem. Contact a water softener company.</p>
	<b>White film on inside surface— hard water minerals</b>	<p>GE Appliances recommends Finish® Jet-Dry® Rinse Aid to help prevent hard water mineral deposits from</p>



		forming. Run dishwasher with citric acid to remove mineral deposits. Citric acid (Part number: WD35X151) can be ordered through GE Appliances Parts. See Consumer Support section for ordering information. Alternatively, purchase Finish® Dishwasher Cleaner and follow the directions on the label.
<b>Dishwasher won't run</b>	<b>Fuse is blown or circuit breaker is tripped</b>	Replace fuse or reset circuit breaker. Remove any other appliances from the circuit.
	<b>Power is turned off</b>	In some installations, the power to the dishwasher is provided through a wall switch, often located next to the disposer switch. Make sure it is on
<b>Control panel lights go off when you're setting controls</b>	<b>Time too long between touching of selected pads</b>	Each pad must be touched within 30 seconds of the others. To relight, touch any pad again or unlatch and relatch the door.
<b>Water standing in the bottom of the tub</b>	<b>This is normal</b>	A small amount of clean water around the outlet on the tub bottom at the back of the tub keeps the water seal lubricated.
<b>Water won't pump out of the tub</b>	<b>Drain is clogged</b>	If you have an air gap, clean it. See the Care and Cleaning section. If the dishwasher drains into a disposer, run disposer clear. Check to see if your kitchen



		sink is draining well. If not, you may need a plumber.
<b>Steam</b>	<b>This is normal</b>	Warm, moist air comes through the vent during drying and when water is being pumped out. This is necessary for drying.
<b>Sanitized light does not illuminate at the end of the cycle</b>	<b>The door was opened and the cycle was interrupted during final rinse</b>	Do not interrupt the cycle by opening the door during the wash cycle.
	<b>The incoming water temperature was too low</b>	Raise the water heater temperature to between 120°F and 150°F
<b>Noise</b>	<b>Normal operating sounds: Hard food disposer shredding action. Drain valve opening to pump water out. Timer control as cycle progresses. Detergent cup opening. The motor stopping during the drying period. Water draining out of tub immediately after touching the start/reset pad.</b>	These are all normal. No action is required.
	<b>Utensils are not secure in rack or something small has dropped into rack</b>	Make sure everything is secured in dishwasher.
	<b>Rattling dishes when the spray arm rotates</b>	Make sure dishes are properly loaded. See the Loading section.
	<b>Rattling silverware against door during wash</b>	Tall utensils may be placed in the upper rack to avoid bumping against inner door during wash cycle.



	<b>Motor hums</b>	Dishwasher has not been used on a regular basis. If you do not use your dishwasher often, set it to fill and pump out once every week. This will help keep the seal moist.
--	-------------------	--

**Warning**

This content is compiled from multiple sources and is provided for reference purposes only. It may not be complete or fully applicable to all situations. If you are unable to resolve your issue, please contact the product manufacturer or an authorized service provider for official support.

