

Getting to know your Hoover® FUSION™ Cordless Vacuum

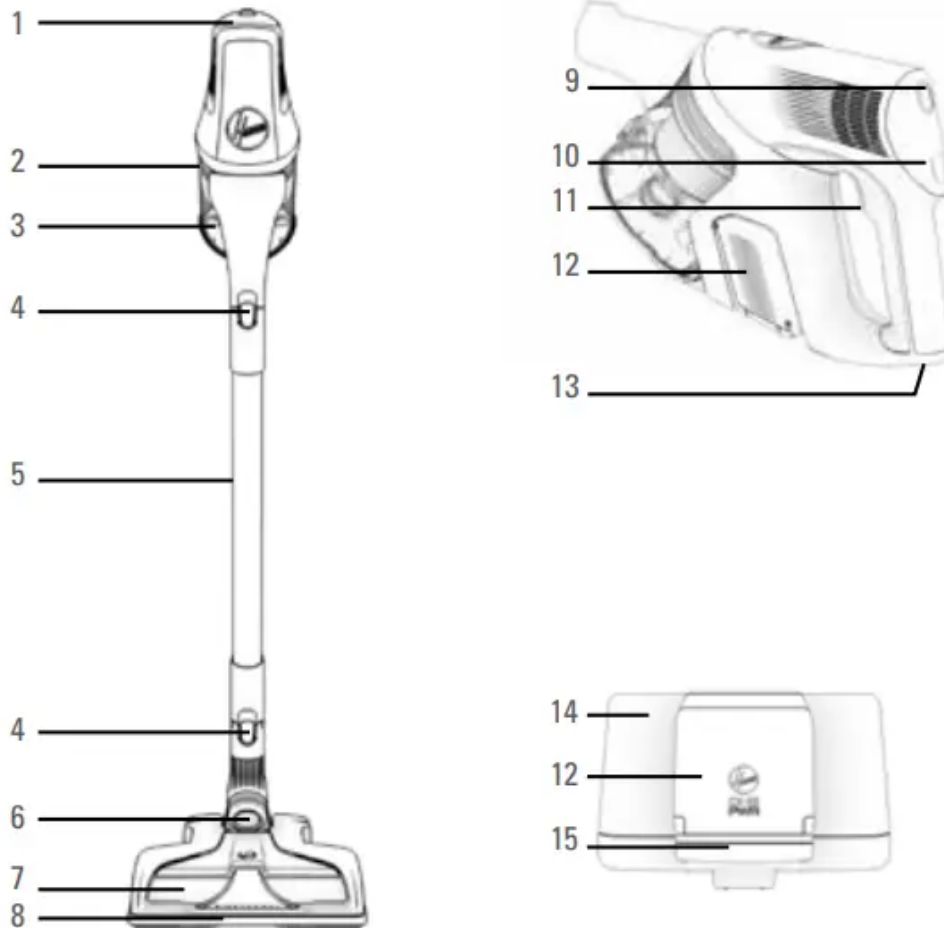

1. Hoover® Dashboard
2. XL Easy Empty Dirt Cup
3. Dirt Empty Button
4. Release Button
5. Reach Wand
6. Swivel Steering
7. Easy Clean Brush Roll
8. Powered Nozzle with WindTunnel® Technology
9. Battery Level Indicator
10. Mode Button
11. Power Trigger
12. ONE PWR™ Lithium Battery



13. ONE PWR™ Lithium Battery Release Button

14. ONE PWR™ Charger

15. Charger Dashboard

Assembly

1

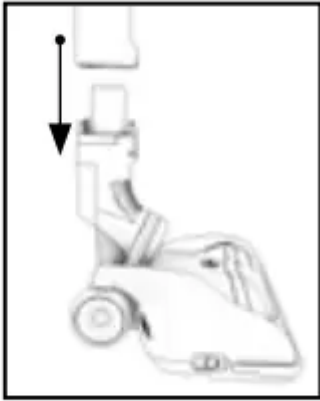

- Push the Reach Wand down onto the Powered Nozzle until it clicks into place.

2

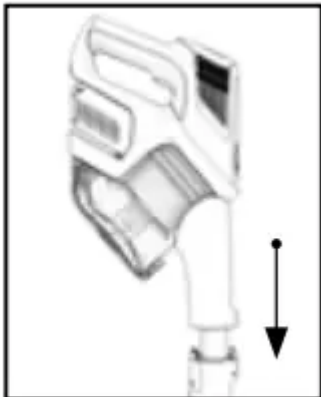

- Push the Handheld down onto the Reach Wand until it clicks into place.

3



- Before first use be sure to fully charge the battery. TIP: Charging your ONE PWR™ Lithium Battery may take up to 3 hours

WARNING: To reduce the risk of personal injury, remove battery before cleaning or servicing.

IMPORTANT: This vacuum cleaner is not free standing. In between uses or when carrying out any maintenance always lie flat on the floor in a suitable location so it does not become a trip hazard or can be stepped on.

Mounting the Wall Bracket

First, fully assemble the vacuum but do not attach the battery.

1

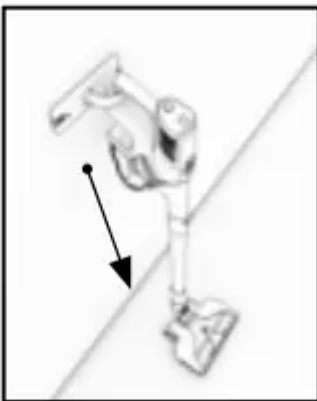

- Install the Wall Bracket arm to the Wall Bracket. Hold the vacuum against the wall. Position the Wall Bracket behind the Handheld so that the hook holds the vacuum. TIP: The Floor Nozzle must be flat on the ground for proper wall mounting.

2



- Set the vacuum aside. Mark the Wall Anchor locations. Install the anchors and screw the Wall Bracket to the wall. **IMPORTANT:** Use **BOTH** screws to mount the Wall Bracket to wall.

3

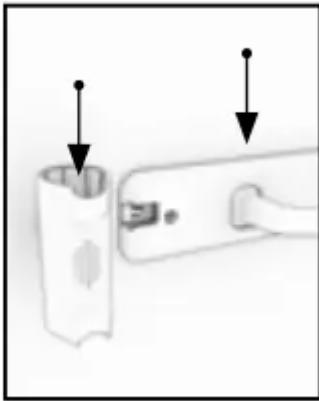

- Slide tool storage part into the slot on the wall mount bracket until it locks into place.

Charging your ONE PWR™ Lithium Battery

1



- Charge the battery fully before first use, this will take up to 3 hours. NOTE: Due to federal regulations the battery does not come fully charged.

2







- When charging, the charger will illuminate to indicate charging progress. See below for charger indicator explanation.

3



- Once charge is complete, remove the ONE PWR™ Lithium Battery from the charger and place it into the handheld for cleaning.

	Continuous white light, battery is charged
	Pulsing white light, battery is charging
	Pulsing yellow light, battery waiting to charge will resume shortly
	Solid red light, please refer to Maintenance sections for Troubleshooting

The Hoover® Dashboard



1

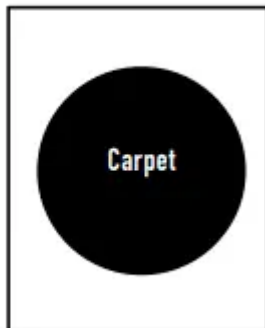

- The Hoover® Dashboard illuminates when the vacuum is ON. The default setting is Carpet. The brush roll is at full speed.

2



- Press the Mode button to transition to Hard Floor. Hard Floor will illuminate and brush roll speed will be Low.

3

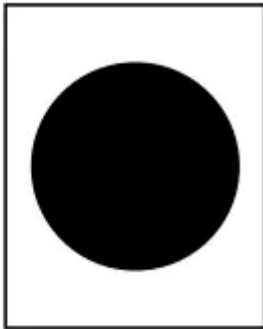

- When no words are illuminated on the Hoover® Dashboard, the vacuum is running on suction only. The brush roll is OFF.

4



- The Hoover® Dashboard will light up if there is a System error. Refer to the Maintenance section for further information.

Quick Start



1. Multi-Floor Cleaning
2. Handheld Cleaning
3. Up High Cleaning

Using your Vacuum

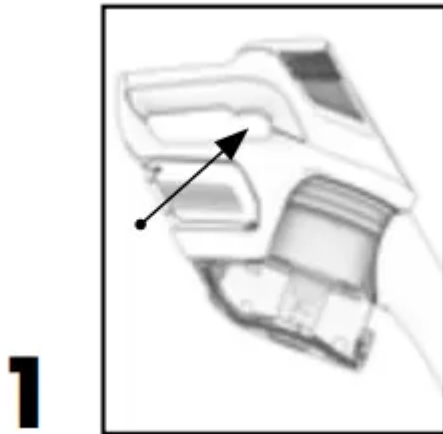

- Squeeze the trigger to turn the vacuum ON. Release the trigger to shut the vacuum OFF.
NOTE: When power is ON, the Hoover® Dashboard will light up

2

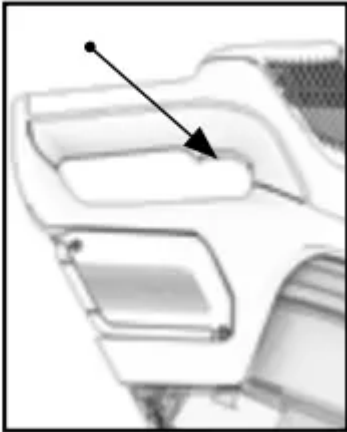

- For continuous power, double-click the trigger. Power should remain ON. Pull trigger again to power OFF.

3



- Push the “Mode” button on the Hoover® Dashboard to go between Carpet, Hard Floor, and Suction Only mode. The vacuum will default to “Carpet” mode. NOTE: If there’s no words illuminated, the vacuum will be in “Suction Only Mode”.

4



- When in use, the Hoover® Dashboard will display the battery level and selected mode. When the battery level is getting low, recharge the battery.

WARNING: This vacuum cleaner has a constantly rotating brush roll when the Hoover® Dashboard displays “Carpet” or “Hardfloor”. Never leave the vacuum cleaner in one spot for an extended period of time as this may damage the floor surface.

WARNING: Risk of personal injury – the brush roll may suddenly restart. Turn power switch OFF and remove the battery before cleaning or servicing the brush roll.

Using your Vacuum as a Handheld

1

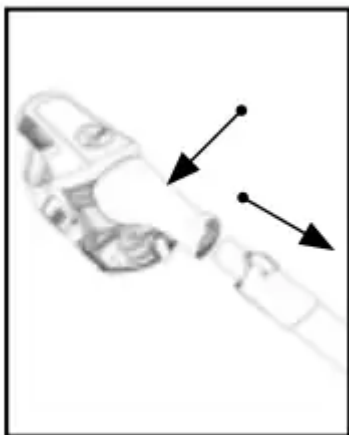

- Press the Handheld release button. Pull to separate the Handheld from the Reach Wand.

2



- Choose an accessory. (All accessories not available on all models).

3

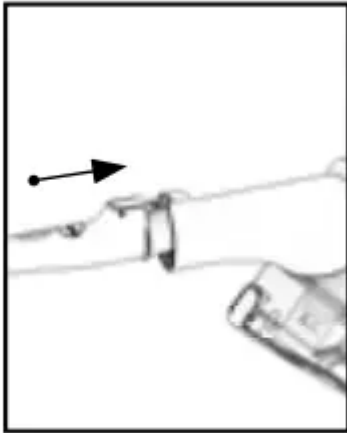

- Push the chosen accessory into the Handheld until it clicks into place. TIP: All available accessories can be attached directly onto the Handheld.

IMPORTANT: Not to be used for grooming a pet.

IMPORTANT: This vacuum cleaner is not free standing. In between uses or when carrying out any maintenance always lie flat on the floor in a suitable location so it does not become a trip hazard or can be stepped on.

Using your Vacuum to Clean Up High

1

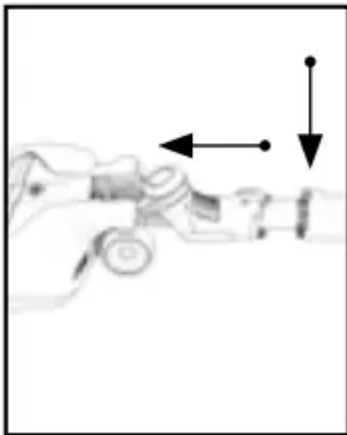

- Press the Powered Nozzle release button and pull to remove the Powered Nozzle from the Reach Wand.

2



- Choose an accessory (all accessories not available on all models).

3

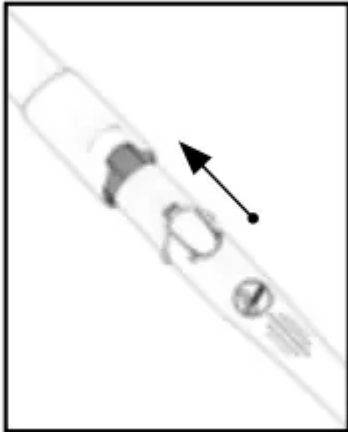

- Push the chosen accessory into the Reach Wand until it clicks into place. TIP: The Reach Wand can be used for hard-to-reach places.

IMPORTANT: This vacuum cleaner is not free standing. In between uses or when carrying out any maintenance always lie flat on the floor in a suitable location so it does not become a trip hazard or can be stepped on.

Maintenance

Removing the ONE PWR™ Lithium Battery

1



- Lie the Handheld on its side on a flat stable surface. Pull the “Battery Release Button” back to release the ONE PWR™ Lithium Battery

2

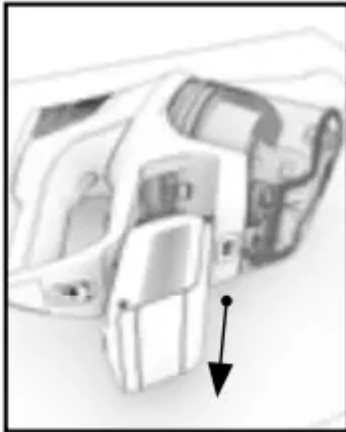

- Slide the ONE PWR™ Lithium Battery out from the bottom of the Handheld.

3



- Place ONE PWR™ Lithium Battery on charger.

WARNING: To reduce the risk of personal injury, remove battery before maintaining or servicing your vacuum.

Emptying the Dirt Cup

1

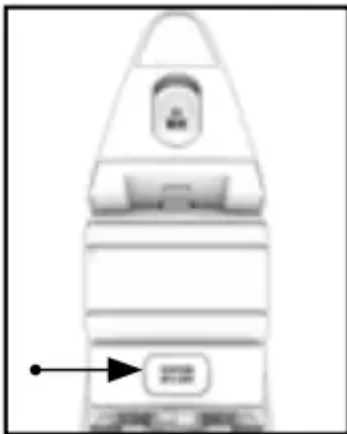

- Press the Handheld release button. Pull to separate the Handheld from the Reach Wand.

2



- Ensure the ONE PWR™ Lithium Battery has been removed and hold the Handheld over a trash bin. TIP: Wrap bag around dirt cup to capture dirt and dust.

3



- Press the dirt cup release button.

WARNING: To reduce the risk of personal injury, remove battery before maintaining or servicing your vacuum.

IMPORTANT: This vacuum cleaner is not free standing. In between uses or when carrying out any maintenance always lie flat on the floor in a suitable location so it does not become a trip hazard or can be stepped on.

Cleaning the Filter, Dirt Cup and Separator

1

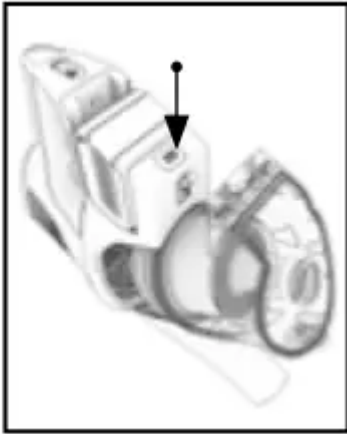

- Remove the Reach Wand. Press the Dirt Cup release button and pull the Dirt Cup away

2



- Pull the filter away and tap over a trash bin to remove dirt. Rinse filter under warm water until water is clear. Allow filter to dry for 24 hours or until completely dry before reinstalling.

3



- To clean the separator, lift to remove. Clean dirt & debris, then place back into dirt cup.

4



- To reassemble, align the hook to the front. Push the dirt cup backwards, until it locks in place.

WARNING: To reduce the risk of personal injury, remove battery before cleaning or servicing.

IMPORTANT: Do not use soap or other chemicals to clean. Dry filter completely, for up to 24 hours, before reinstalling into the product.

Removing and Replacing the Brush Roll

1



- Remove Powered Nozzle from Reach Wand. Turn the Powered Nozzle upside down. Slide the Brush Roll Release Button.

2

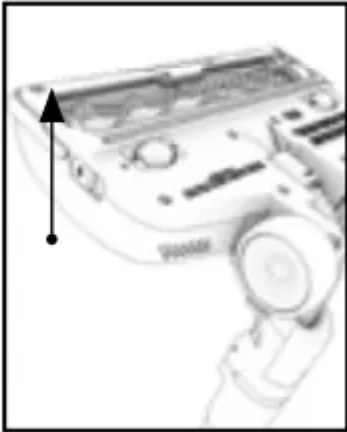

- Lift the end of brush roll to remove from the Powered Nozzle.

3



- Clear any threads or hair from both ends of the brush roll and any dirt or debris inside the housing of the Powered Nozzle.

4



- Re-fit the brush roll into the housing

WARNING: Risk of personal injury – the brush roll may suddenly restart. Turn power OFF and remove the battery before cleaning or servicing the brush roll.

Troubleshooting

1. My Hoover® FUSION™ Cordless Vacuum won't turn on.

- Your battery may not be charged. Check the Charge Level Indicator and charge the battery if it's low. Charge time may take up to 3 hours. Due to federal regulations the battery does not come fully charged.

2. My Hoover® FUSION™ Cordless Vacuum isn't picking up well.

- You may have a clogged filter. Your filter should be rinsed every 4-6 times you fill the dirt cup or at least once a month. Remove the filter. Rinse with clear warm water for two minutes. Let it dry for 24 hours or until completely dry before reinstalling it.

3. If your suction power seems low.

- You may also have a clog in the system. Check the Reach Wand for any clogged debris. If found, remove the clog.

4. My Hoover® FUSION™ Cordless Vacuum is not picking up well on carpet.

- Make sure that your display shows that you're in "Carpet" mode. If you're not, push the mode button until "Carpet" illuminates on the display.

WARNING: To reduce the risk of personal injury, remove battery before cleaning or servicing.

Warning

This content is compiled from multiple sources and is provided for reference purposes only. It may not be complete or fully applicable to all situations. If you are unable to resolve your issue, please contact the product manufacturer or an authorized service provider for official support.