

INSTALLATION

This Use & Care Guide provides general operating instructions for your model. Use the refrigerator only as instructed in this Use & Care Guide. Before starting the refrigerator, follow these important first steps.

Location

- Choose a place that is near a grounded electrical outlet. Do Not use an extension cord or an adapter plug.
- If possible, place the refrigerator out of direct sunlight and away from the range, dishwasher or other heat sources.
- The refrigerator must be installed on a floor that is level and strong enough to support a fully loaded refrigerator.
- Consider water supply availability for models equipped with an automatic ice maker. If you do not hook up water to the refrigerator, remember to turn the ice maker off.

CAUTION

Do Not install the refrigerator where the temperature will drop below 55°F (13°C) or rise above 110°F (43°C). The compressor will not be able to maintain proper temperatures inside the refrigerator.

Do Not block the toe grille on the lower front of your refrigerator. Sufficient air circulation is essential for the proper operation of your refrigerator.

Installation

Installation clearances

- Allow the following clearances for ease of installation, proper air circulation, and plumbing and electrical connections:

Sides & Top ½ inch

Back 1 inch

NOTE

If your refrigerator is placed with the door hinge side against a wall, you may have to allow additional space so the door can be opened wider.

Leveling

All four corners of your refrigerator must rest firmly on a solid floor. Your refrigerator is equipped with adjustable front rollers or front leveling screws to help level your unit.

To level your refrigerator:

1. Remove toe grille.



2. Use flatblade screwdriver or $\frac{3}{8}$ " socket wrench to adjust front rollers. Use adjustable wrench to adjust leveling screws.

NOTE Raise the front of the refrigerator enough so the doors close freely when opened halfway. The refrigerator should slope $\frac{1}{4}$ " to $\frac{1}{2}$ " from front to back. Then level the refrigerator from side-to-side.

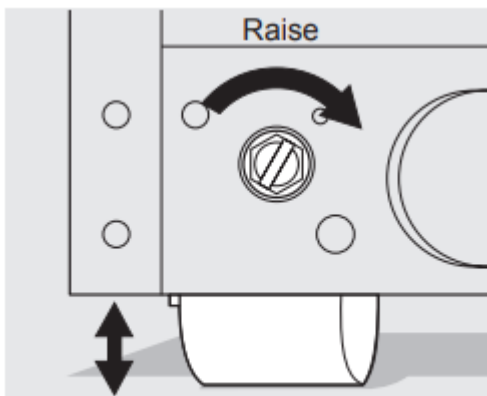

Adjustable Front Roller (some models)

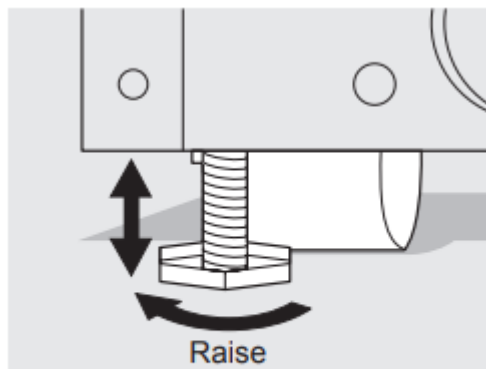

Stationary Front Roller with Leveling Screw (some models)

DOOR REMOVAL INSTRUCTIONS

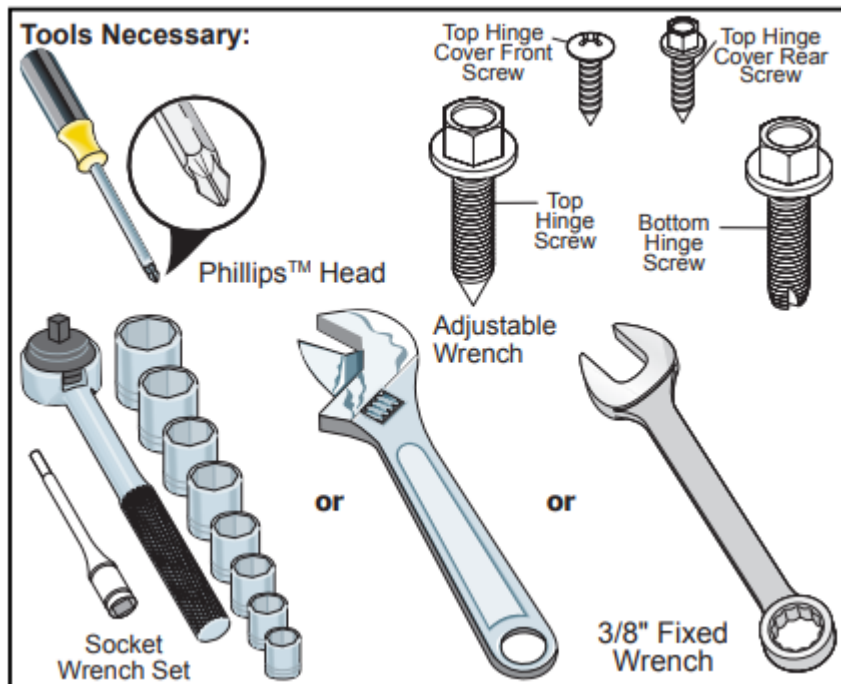

Door removal and reversal instructions:

1. Remove toe grille.
2. Remove top hinge cover. Trace around the hinge with a soft lead pencil. This makes reinstallation easier. Remove top hinge and lift door off center hinge pin. Set door aside.
3. Unscrew center hinge pin using adjustable wrench and save for reassembly. Ensure plastic washer stays on hinge pin.
4. Lift refrigerator door off of bottom hinge and set aside.
5. Remove center hinge and shim by removing inside screw and loosening two outside screws enough to allow hinge and shim to slide out. Tighten screws.
6. Loosen two outside screws on opposite side of refrigerator, remove inside screw and install center hinge.
7. Remove two screws on bottom hinge with $\frac{5}{8}$ " socket wrench.
8. Install bottom hinge on opposite side with the two screws removed from step 7.
9. Unscrew bottom hinge pin using adjustable wrench. Move hinge pin to other hole in hinge and tighten with adjustable wrench.
10. Reverse door handles (see instruction on next page).
11. Move freezer and refrigerator door stops to opposite side. Before starting screws, use an awl to puncture the foam.
12. Position refrigerator door onto bottom hinge pin and screw center hinge pin through center hinge into top of door. Close refrigerator door to help align hinge hole.

13. Tighten center hinge pin with adjustable wrench.
14. Remove cabinet and hinge hole plugs and move to opposite side.
15. Lower freezer door onto center hinge pin.
16. Close freezer door. Have an assistant lift up on opposite side of door while tightening screws to install top hinge.
17. Flip toe grille and reinstall.
18. Plug in electrical power cord and turn refrigerator temperature control to center position.
Adjust setting as necessary.

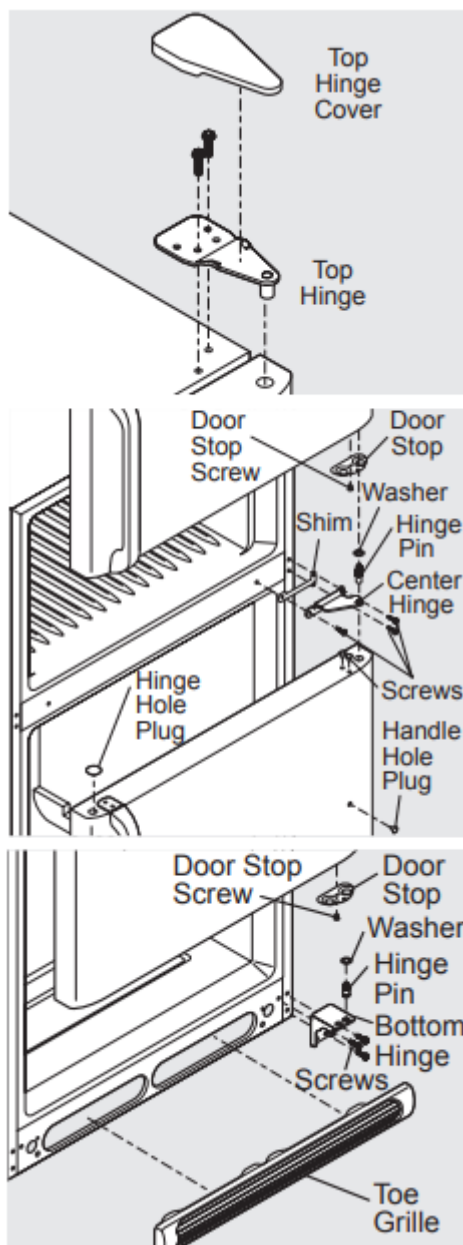

HANDLE INSTALLATION

To ensure proper installation of handles, please review these instructions and illustrations thoroughly prior to installing the handles.

Additionally, before installing the door handles, make sure the door swing is correct. Your model will have either a right hand or left hand door swing. Follow instructions in the Use & Care Guide to reverse the doors, if necessary.

To attach metal refrigerator handle:

1. Place rounded part of handle onto shoulder screw on face of door and align the two holes in top of handle with the two holes in top of door. Do not tighten the set screw yet.
2. Install the two screws into the top of the handle.
3. Tighten the set screw on the rounded part of the handle until the handle is flush with the door, then tighten another 1/2 turn.



To attach metal freezer handle:

1. Place rounded part of handle onto shoulder screw on face of door and align the two holes in bottom of handle with the two holes in bottom of door. Do not tighten the set screw yet.
2. Install the two screws into the bottom of the handle.
3. Tighten the set screw on the rounded part of the handle until the handle is flush with the door, then tighten another 1/2 turn.



Stainless Steel Models

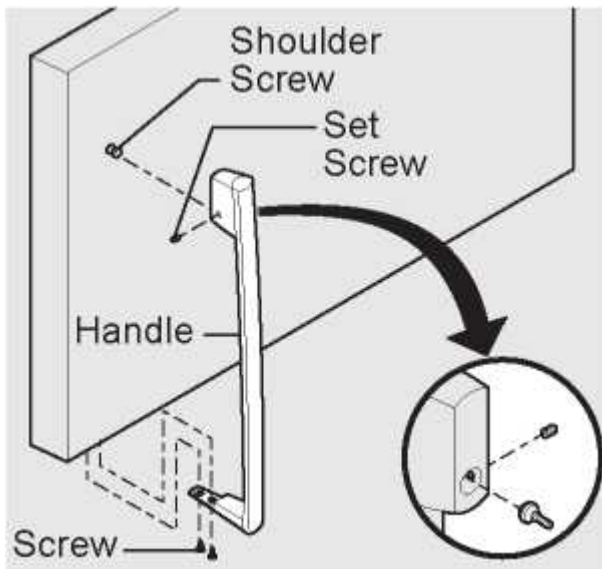
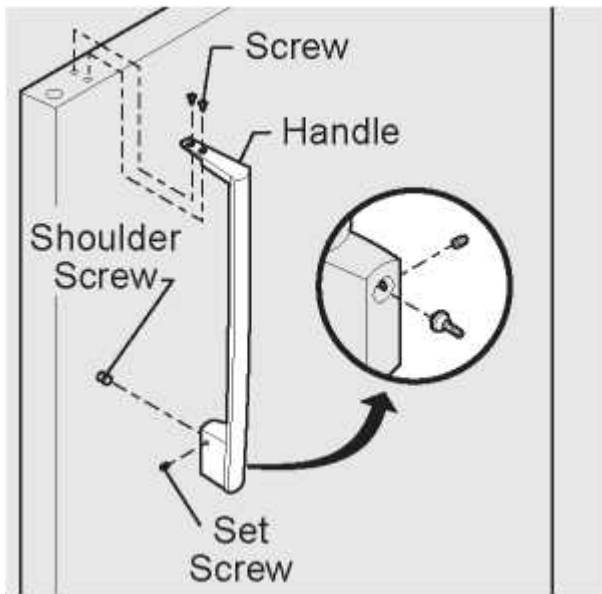

To attach plastic refrigerator handle:

1. Place top of handle over dovetail screw, pull handle straight down until handle is aligned with screw holes on top of door.
2. Secure top of handle with two screws.



To attach plastic freezer handle:

1. Place top of handle over dovetail screw, pull handle straight up until handle is aligned with screw holes on bottom of door.
2. Secure bottom of handle with two screws.



To reverse refrigerator/freezer handles:

Handles may be easier to reverse while doors are off. Reverse freezer and refrigerator handles as shown.



CONNECTING THE WATER SUPPLY

Before Installing The Water Supply Line, You Will Need:

- Basic Tools: adjustable wrench, flat-blade screwdriver, and Phillips™ screwdriver
- Access to a household cold water line with water pressure between 30 and 100 psi.
- A water supply line made of 1/4 inch (6.4 mm) OD, copper or stainless steel tubing. To determine the length of tubing needed, measure the distance from the ice maker inlet valve at the back of the refrigerator to your cold water pipe. Then add approximately 7 feet (2.1 meters), so the refrigerator can be moved out for cleaning (as shown).
- A shutoff valve to connect the water supply line to your household water system. DO NOT use a self-piercing type shutoff valve.
- A compression nut and ferrule (sleeve) for connecting a copper water supply line to the ice maker inlet valve.

To Connect Water Supply Line To Ice Maker Inlet Valve

1. Disconnect refrigerator from electric power source.
2. Place end of water supply line into sink or bucket. Turn ON water supply and flush supply line until water is clear. Turn OFF water supply at shutoff valve.
3. Remove plastic cap from water valve inlet and discard cap.
4. If you use copper tubing - Slide brass compression nut, then ferrule (sleeve) onto water supply line. Push water supply line into water valve inlet as far as it will go (1/4 inch / 6.4 mm). Slide ferrule (sleeve) into valve inlet and finger tighten compression nut onto valve. Tighten another half turn with a wrench; DO NOT over tighten. See Figure 1.

If you use stainless steel tubing - The nut and ferrule are already assembled on the tubing. Slide compression nut onto valve inlet and finger tighten compression nut onto valve. Tighten another half turn with a wrench; DO NOT over tighten. See Figure 2.

5. With steel clamp and screw, secure water supply line (copper tubing only) to rear panel of refrigerator as shown.

6. Coil excess water supply line (copper tubing only), about 2% turns, behind refrigerator as shown and arrange coils so they do not vibrate or wear against any other surface.

7. Turn ON water supply at shutoff valve and tighten any connections that leak.

8. Reconnect refrigerator to electrical power source.

9. To turn ice maker on, lower wire signal arm (side mounted) or set the ice maker's On/Off power switch to the "I" position (rear mounted).



Figure 1



Figure 2

ICE SERVICE

If your refrigerator has an automatic ice maker, minimal ice will be produced during the first 24 hours of operation. Air in new plumbing lines may cause the ice maker to cycle two or three times before making a full tray of ice. With no usage, it will take approximately one to two days to fill the

ice container. New plumbing connections may cause the first production of ice cubes to be discolored or have an odd flavor. Discard ice made during the first 24 hours

Turning your Ice Maker On

After the plumbing connections have been completed, the water supply valve must be opened. Place the ice container under the ice maker, pushing it as far back as possible. Lower the wire signal arm to its "down" or ON position.

To stop the ice maker, lift the wire signal arm until it clicks and locks in the "up" or OFF position. The ice maker also turns off automatically when the ice container is full.



IMPORTANT Your ice maker is shipped from the factory with the wire signal arm in the ON position. To ensure proper function for your ice maker, hook up water supply immediately or turn ice maker OFF by lifting the wire signal arm until it clicks and locks in the UP position. If the ice maker is on and the water supply is not connected, the water valve will make a loud chattering noise.

MECHANICAL CONTROLS

Cool Down Period

To ensure safe food storage, allow the refrigerator to operate with the doors closed for at least 8 hours before loading it with food.

Refrigerator & Freezer Controls (some models)



Temperature Adjustment

- Adjust temperature gradually: move the knob in small increments, allowing the temperature to stabilize.

Turning the refrigerator/freezer control will change temperatures in both compartments. The auxiliary freezer control has no effect on electrical power to the refrigerator.

To maintain temperatures, a fan circulates air in the refrigerator and freezer compartments. For good circulation, do not block cold air vents with food items.

ELECTRONIC CONTROLS

Cool Down Period

To ensure safe food storage, allow the refrigerator to operate with the doors closed for at least 8 hours before loading it with food.

Refrigerator & Freezer Controls (some models)



Auxiliary Freezer Control



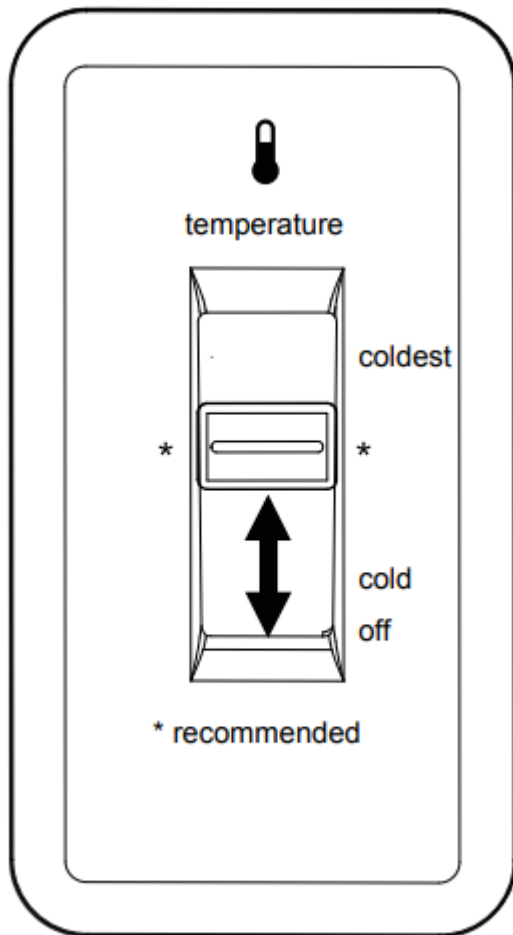

Refrigerator/Freezer Control

Temperature Adjustment

- Adjust temperature gradually: move the knob in small increments, allowing the temperature to stabilize.

Turning the refrigerator/freezer control will change temperatures in both compartments. The auxiliary freezer control has no effect on electrical power to the refrigerator.

To maintain temperatures, a fan circulates air in the refrigerator and freezer compartments. For good circulation, do not block cold air vents with food items.

NORMAL OPERATING SOUNDS AND SIGHTS

Understanding the sounds you may hear

Your new, high-efficiency refrigerator may introduce unfamiliar sounds. These sounds normally indicate your refrigerator is operating correctly. Some surfaces on floors, walls, and kitchen cabinets may make these sounds more noticeable.



Following is a list of major components in your refrigerator and the sounds they can cause:

- A. **Evaporator** Refrigerant through the evaporator may create a boiling or gurgling sound.
- B. **Evaporator fan** You may hear air being forced through the refrigerator by the evaporator fan.
- C. **Defrost heater** During defrost cycles, water dripping onto the defrost heater may cause a hissing or sizzling sound. After defrosting, a popping sound may occur.
- D. **Automatic ice maker** When ice has been produced, you will hear ice cubes falling into the ice bin. The ice maker will produce 2.5 to 3 pounds of ice every 24 hours depending on usage conditions.
- E. **Automatic defrost control** These parts can produce a snapping or clicking sound when turning the cooling system on and off.
- F. **Condenser fan** You may hear air being forced through the condenser.
- G. **Compressor** Modern, high-efficiency compressors run much faster than in the past. The compressor may have a high-pitched hum or pulsating sound.
- H. **Water valve** Makes a buzzing sound each time it opens to fill the ice maker

I. **Drain pan** (not removable) You may hear water dripping into the drain pan during the defrost cycle.

J. **Condenser** May create minimal sounds from forced air.

CARE & CLEANING

Protecting your investment

Keeping your refrigerator clean maintains appearance and prevents odor build-up. Wipe up any spills immediately and clean the freezer and fresh food compartments at least twice a year. When cleaning, take the following precautions:

- Never use CHLORIDE or cleaners with bleach to clean stainless steel.
- Do not wash any removable parts in a dishwasher.
- Always unplug the electrical power cord from the wall outlet before cleaning.
- Remove adhesive labels by hand. Do not use razor blades or other sharp instruments which can scratch the appliance surface.
- Do not remove the serial plate.

Do not use abrasive cleaners such as window sprays, scouring cleansers, brushes, flammable fluids, cleaning waxes, concentrated detergents, bleaches or cleansers containing petroleum products on plastic parts, interior doors, gaskets or cabinet liners. Do not use paper towels, metallic scouring pads, or other abrasive cleaning materials or strong alkaline solutions.

Care & Cleaning Tips		
Part	What To Use	Tips and Precautions
Interior & Door Liners	<ul style="list-style-type: none"> • Soap and water • Baking soda and water 	Use 2 tablespoons of baking soda in 1 quart of warm water. Be sure to wring excess water out of sponge or cloth before cleaning around controls, light bulb or any electrical part.
Door Gaskets	<ul style="list-style-type: none"> • Soap and water 	Wipe gaskets with a clean soft cloth.
Drawers & Bins	<ul style="list-style-type: none"> • Soap and water 	Use a soft cloth to clean drawer runners and tracks.
Glass Shelves	<ul style="list-style-type: none"> • Soap and water • Glass cleaner • Mild liquid sprays 	Allow glass to warm to room temperature before immersing in warm water.
Toe Grille	<ul style="list-style-type: none"> • Soap and water • Mild liquid sprays • Vacuum attachment 	Vacuum dust from front of toe grille. Remove toe grille (see Installation Instructions). Vacuum backside, wipe with sudsy cloth or sponge. Rinse and dry.
Exterior & Handles	<ul style="list-style-type: none"> • Soap and water • Non Abrasive Glass Cleaner 	Do not use commercial household cleaners containing ammonia, bleach or alcohol to clean handles. Use a soft cloth to clean smooth handles. DO NOT use a dry cloth to clean smooth doors.

<p>Exterior & Handles (Stainless Steel Models Only)</p>	<ul style="list-style-type: none"> • Soap and water • Stainless Steel Cleaners 	<p>Never use CHLORIDE or cleaners with bleach to clean stainless steel.</p> <p>Clean stainless steel front and handles with non-abrasive soapy water and a dishcloth. Rinse with clean water and a soft cloth. Use a non-abrasive stainless steel cleaner. These cleaners can be purchased at most home improvement or major department stores. Always follow manufacturer's instructions. Do not use household cleaners containing ammonia or bleach.</p> <p>NOTE: Always clean, wipe and dry with the grain to prevent scratching. Wash the rest of the cabinet with warm water and mild liquid detergent. Rinse well, and wipe dry with a clean soft cloth.</p>
<p>Replacing Light Bulbs</p>	<ul style="list-style-type: none"> • Unplug refrigerator • Wear gloves • Remove light cover • Replace old bulb • Replace light cover • Plug in the refrigerator 	<p>CAUTION: Wear gloves when replacing light bulbs to avoid getting cut. Use same wattage when replacing bulb</p>



BEFORE YOU CALL

<p>Common Occurrences</p>	<p>Before calling for service, review this list. It may save you time and expense. This list includes common occurrences that are not the result of defective workmanship or materials in this appliance.</p>
<p>Refrigerator does not run.</p>	<ul style="list-style-type: none"> • Ensure plug is tightly pushed into electrical outlet. • Check/replace fuse with a 15 amp time-delay fuse. Reset circuit breaker. • The refrigerator/freezer control is turned to "0" (Mechanical controls) or "OFF" (Electronic controls). • Refrigerator may be in defrost cycle. Wait 20 minutes and check again.
<p>Freezer temperature too cold. Refrigerator temperature is satisfactory.</p>	<ul style="list-style-type: none"> • Set auxiliary freezer control to a warmer setting until freezer temperature is satisfactory. Allow 24 hours for the temperature to stabilize.
<p>Refrigerator temperature is too cold. Freezer temperature is satisfactory.</p>	<ul style="list-style-type: none"> • Set refrigerator/freezer control to a warmer setting. Allow 24 hours for temperature to stabilize. Then check freezer temperatures and adjust as needed.
<p>Refrigerator is noisy or vibrates.</p>	<ul style="list-style-type: none"> • The cabinet is not level. • Floor is weak. • See Normal Operating Sounds and Sights section.
<p>Odors in refrigerator.</p>	<ul style="list-style-type: none"> • Interior needs to be cleaned. • Foods that produce odors should be covered or wrapped.
<p>Cabinet light not working.</p>	<ul style="list-style-type: none"> • Replace light bulb. • Ensure plug is tightly pushed into electrical outlet. • Light switch may be stuck. Push in light switch, located on the refrigerator control box, to release.



Automatic ice maker not working (some models)	<ul style="list-style-type: none"> • Ensure the wire signal arm is not in UP position. • Ice maker should produce 2.5 to 3 pounds of ice in a 24 hour period. • Water supply is turned off. • Water pressure is too low. • The freezer is not cold enough.
---	---

MAJOR APPLIANCE WARRANTY

Your appliance is covered by a one year limited warranty. For one year from your original date of purchase, Electrolux will pay all costs for repairing or replacing any parts of this appliance that prove to be defective in materials or workmanship when such appliance is installed, used and maintained in accordance with the provided instructions.

Exclusions

This warranty does not cover the following:

1. Products with original serial numbers that have been removed, altered or cannot be readily determined.
2. Product that has been transferred from its original owner to another party or removed outside the USA or Canada.
3. Rust on the interior or exterior of the unit.
4. Products purchased "as-is" are not covered by this warranty.
5. Food loss due to any refrigerator or freezer failures.
6. Products used in a commercial setting.
7. Service calls which do not involve malfunction or defects in materials or workmanship, or for appliances not in ordinary household use or used other than in accordance with the provided instructions.
8. Service calls to correct the installation of your appliance or to instruct you how to use your appliance.
9. Expenses for making the appliance accessible for servicing, such as removal of trim, cupboards, shelves, etc., which are not a part of the appliance when it is shipped from the factory.
10. Service calls to repair or replace appliance light bulbs, air filters, water filters, other consumables, or knobs, handles, or other cosmetic parts.

11. Surcharges including, but not limited to, any after hour, weekend, or holiday service calls, tolls, ferry trip charges, or mileage expense for service calls to remote areas, including the state of Alaska.

12. Damages to the finish of appliance or home incurred during installation, including but not limited to floors, cabinets, walls, etc.

13. Damages caused by: services performed by unauthorized service companies; use of parts other than genuine Electrolux parts or parts obtained from persons other than authorized service companies; or external causes such as abuse, misuse, inadequate power supply, accidents, fires, or acts of God.

DISCLAIMER OF IMPLIED WARRANTIES; LIMITATION OF REMEDIES

CUSTOMER'S SOLE AND EXCLUSIVE REMEDY UNDER THIS LIMITED WARRANTY SHALL BE PRODUCT REPAIR OR REPLACEMENT AS PROVIDED HEREIN. CLAIMS BASED ON IMPLIED WARRANTIES, INCLUDING WARRANTIES OF MERCHANTABILITY OR FITNESS FOR A PARTICULAR PURPOSE, ARE LIMITED TO ONE YEAR OR THE SHORTEST PERIOD ALLOWED BY LAW, BUT NOT LESS THAN ONE YEAR. ELECTROLUX SHALL NOT BE LIABLE FOR CONSEQUENTIAL OR INCIDENTAL DAMAGES SUCH AS PROPERTY DAMAGE AND INCIDENTAL EXPENSES RESULTING FROM ANY BREACH OF THIS WRITTEN LIMITED WARRANTY OR ANY IMPLIED WARRANTY. SOME STATES AND PROVINCES DO NOT ALLOW THE EXCLUSION OR LIMITATION OF INCIDENTAL OR CONSEQUENTIAL DAMAGES, OR LIMITATIONS ON THE DURATION OF IMPLIED WARRANTIES, SO THESE LIMITATIONS OR EXCLUSIONS MAY NOT APPLY TO YOU. THIS WRITTEN WARRANTY GIVES YOU SPECIFIC LEGAL RIGHTS. YOU MAY ALSO HAVE OTHER RIGHTS THAT VARY FROM STATE TO STATE.

If You Need Service

Keep your receipt, delivery slip, or some other appropriate payment record to establish the warranty period should service be required. If service is performed, it is in your best interest to obtain and keep all receipts. Service under this warranty must be obtained by contacting Electrolux at the addresses or phone numbers below.

This warranty only applies in the USA and Canada. In the USA, your appliance is warranted by Electrolux Major Appliances North America, a division of Electrolux Home Products, Inc. In Canada, your appliance is warranted by Electrolux Canada Corp. Electrolux authorizes no person to change or add to any obligations under this warranty. Obligations for service and parts under this warranty must be performed by Electrolux or an authorized service company. Product features or specifications as described or illustrated are subject to change without notice.

Warning

This content is compiled from multiple sources and is provided for reference purposes only. It may not be complete or fully applicable to all situations. If you are unable to resolve your issue, please contact the product manufacturer or an authorized service provider for official support.

Document generated by [ManualsFile](#)

