

Quick Steps

1. Prepare and load dishwasher.

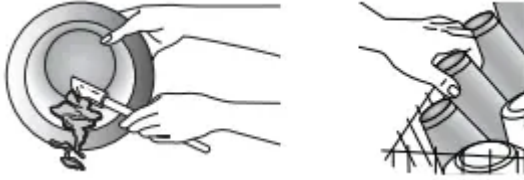

2. Add detergent for cleaning and rinse aid for drying.



3. Select a cycle and option.

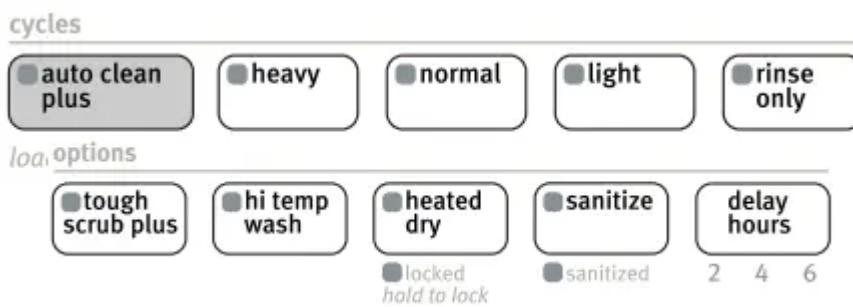

4. Start dishwasher.



Dishwasher Use

STEP 1

Prepare and Load the Dishwasher

IMPORTANT: Remove leftover food, bones, toothpicks and other hard items from the dishes. Remove labels from containers before washing.

Rack loading

Upper rack

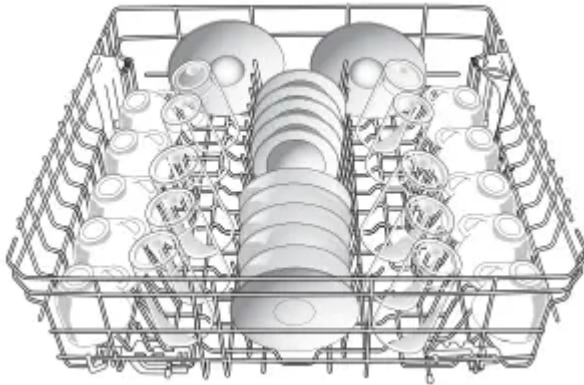

Lower rack

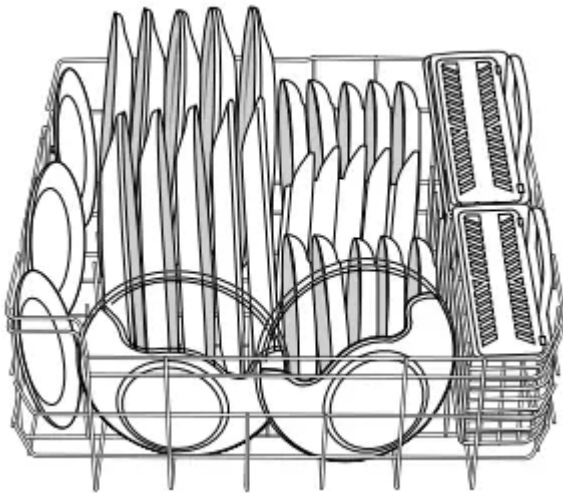

Alternative rack loading

Upper rack

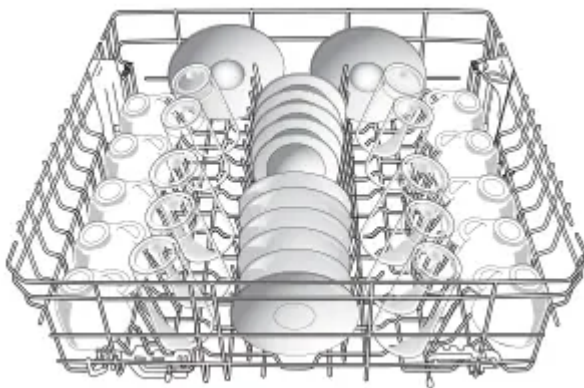

Lower rack

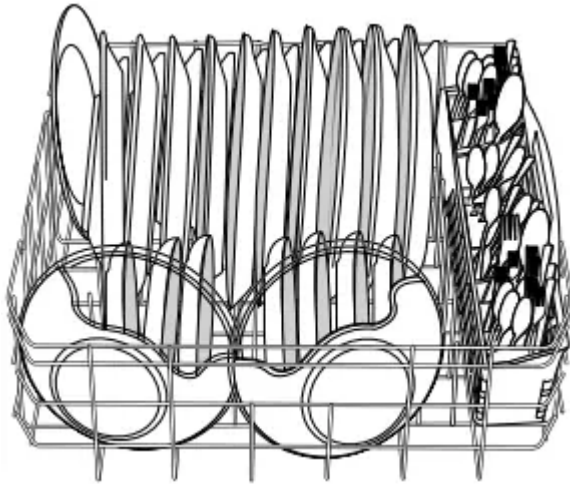

- Make sure nothing keeps spray arm(s) from spinning freely. It is important for the water spray to reach all soiled surfaces.

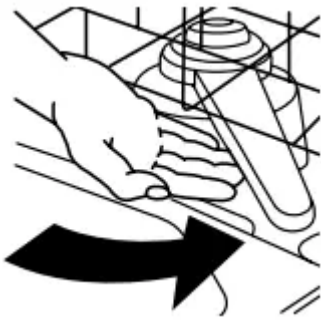

- Make sure that when the dishwasher door is closed no items are blocking the detergent dispenser.
- Items should be loaded with soiled surfaces facing down and inward to the spray as shown. This will improve cleaning and drying results.
- Avoid overlapping items like bowls or plates that may trap food.
- Place plastics, small plates and glasses in the upper rack. Wash only plastic items marked "dishwasher safe."
- To avoid thumping/clattering noises during operation: Load dishes so they do not touch one another. Make sure lightweight load items are secured in the racks.
- When loading silverware, always place sharp items pointing down. Mix some of the items having some pointing up and some items pointing down.



STEP 2

Add Detergent

NOTE: If you do not plan to run a wash cycle soon, run a rinse cycle. Do not use detergent.

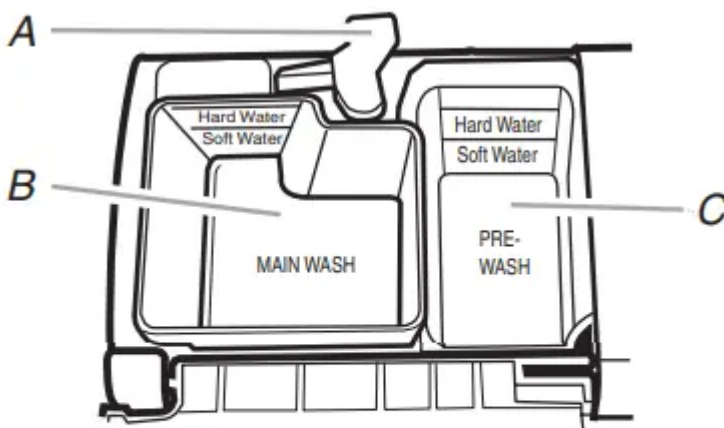

- A. Cover latch*
- B. Main Wash section*
- C. Pre-Wash section*

- Use automatic dishwasher detergent only. Add powder, liquid or tablet detergent just before starting a cycle.
- Fresh automatic dishwasher detergent results in better cleaning. Store tightly closed detergent container in a cool, dry place.
- The amount of detergent to use depends on:

How much soil remains on the items - Heavily soiled loads require more detergent.

The hardness of the water - If you use too little in hard water, dishes won't be clean. If you use too much in soft water, glassware will etch.

Soft to Medium Water (0-6 grains per U.S. gallon) [typical water softener water and some city water]

Medium to Hard Water (7-12 grains per U.S. gallon) [well water and some city water]

- Depending on your water hardness. fill the Main Wash section of the dispenser as shown. Fill the Pre-Wash section to the level shown. if needed.

NOTE: Fill amounts shown are for standard powdered detergent. Follow instructions on the package when using other dishwasher detergent.

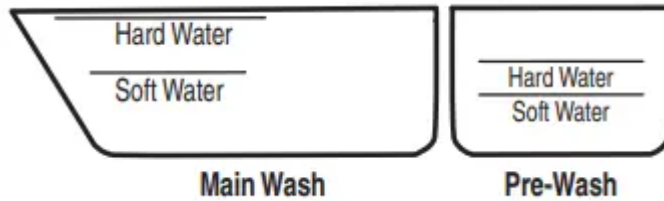

Add Rinse Aid

Your dishwasher is designed to use rinse aid for good drying performance. Without rinse aid your dishes and dishwasher interior will have excessive moisture. The heat dry option will not perform as well without rinse aid.

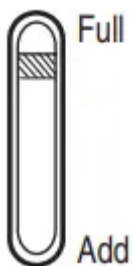

- Rinse aid keeps water from forming droplets that can dry as spots or streaks. It also improves drying by allowing water to drain off of the dishes after the final rinse.
- Rinse aid helps to reduce excess moisture on the dish racks and interior of your dishwasher.
- Check the rinse aid indicator. Add rinse aid when indicator drops to “Refill” level.
- To add rinse aid. turn the dispenser cap counterclockwise and lift off. Pour rinse aid into the opening until the indicator window looks full. Replace the dispenser cap and turn clockwise. Make sure cap is fully locked.

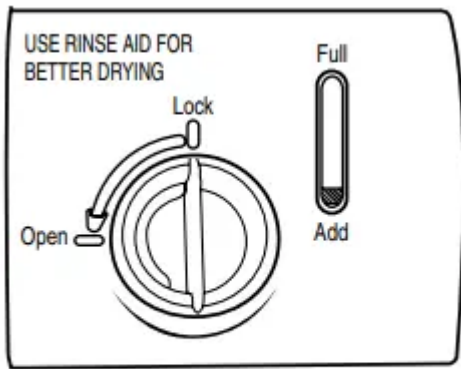

¼ turn to lock

NOTE: For most water conditions, the factory setting of 2 will give good results. If you have hard water or notice rings or spots, try a higher setting. Turn the arrow adjuster inside the dispenser by either using your fingers or inserting a flat-blade screwdriver into the center of the arrow and turning.



STEP 3

Select a Cycle (cycles vary by model)

Heavier cycles and options affect cycle length. Some cycles and options will take up to 3½ hours to complete.

cycles



load sensing technology

Select Options (options vary by model)

You can customize your cycles by pressing the options desired and press Start/Resume.

options



STEP 4

Start or Resume a Cycle

- Run hot water at the sink nearest your dishwasher until the water is hot. Turn off water.
- Push door firmly closed. The door latches automatically. Select the wash cycle and options desired and press START/RESUME OR press START/ RESUME to repeat the same cycle and options as in the previous wash cycle.
- You can add an item anytime before the main wash starts. Open the door slowly and add the item. Close the door firmly. Press the START/RESUME button. the cycle resumes automatically at the point of interruption.



For fully integrated models (controls on top of console)

- Select the wash cycle and options desired.
- Press the START/RESUME button once and close the door. After a brief pause. the cycle will begin. The door must be closed within 3 seconds after pushing START/RESUME or the lights will flash. and the dishwasher will not begin. Press the START/RESUME button again and shut the door within 3 seconds.

You can add an item anytime before the main wash starts. Open the door slowly and add the item. Press the START/RESUME then close the door.

Cycle and Option Descriptions

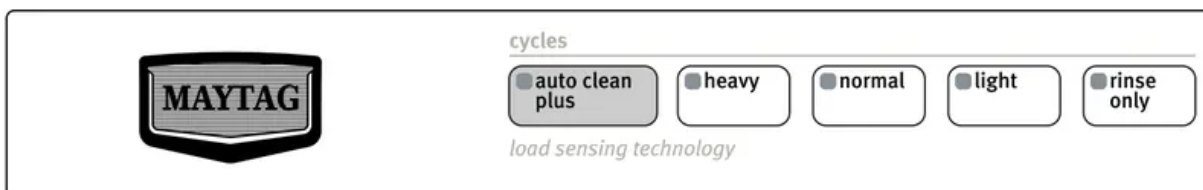

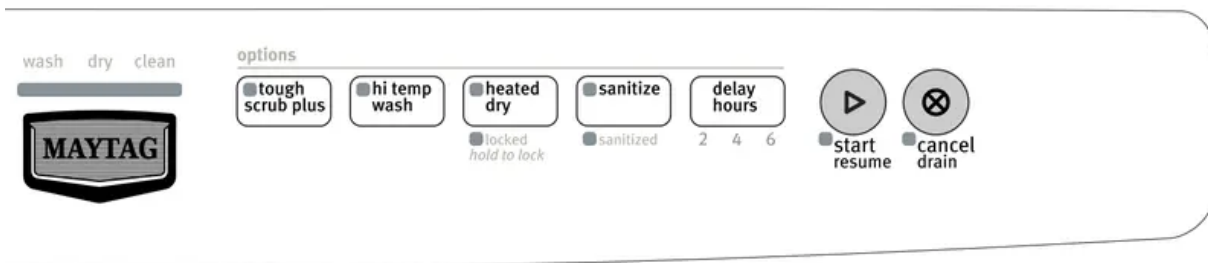
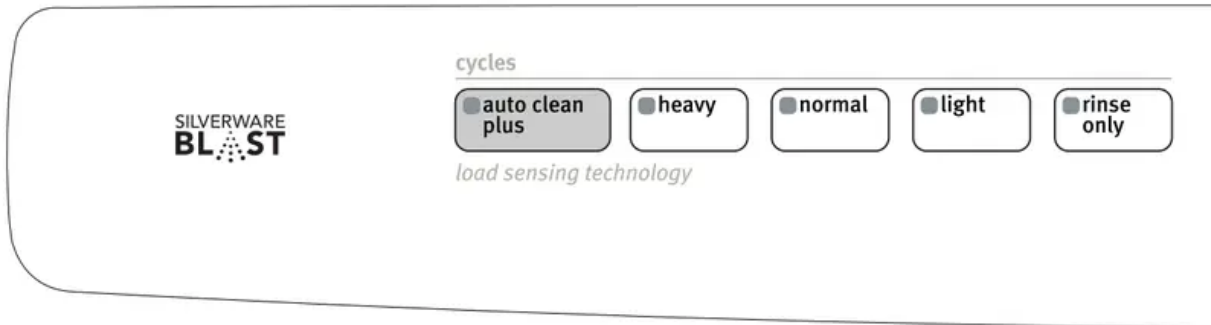
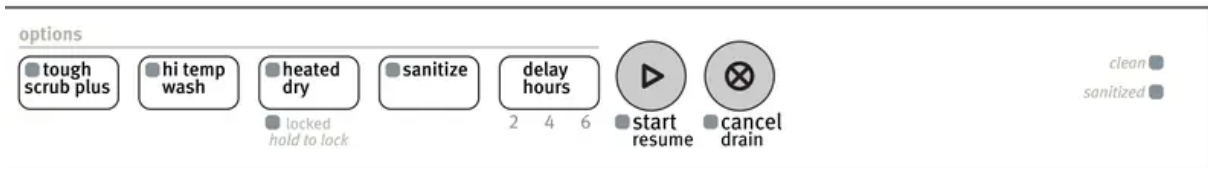



This information covers several different models. Your dishwasher may not have all the cycles and options described.

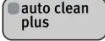
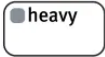
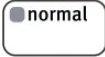

CYCLE SELECTIONS

CYCLES	DISH LOAD TYPES	DESCRIPTIONS	WASH TIME (HH:MM)		
			Cycle Minimum	Cycle + Options Minimum	*Maximum
	Use for any loads with heavy, normal or light amounts of food soil.	Designed to select the number of water fills best suited for the soil level of each load. During the wash, the wash action will repeatedly pause for several seconds.	0:55	1:21	3:39
	Use for hard-to-clean, heavily soiled pots, pans, casseroles, and regular tableware.	This cycle forces maximum time water and heat. During the wash, the wash action will repeatedly pause for several seconds.	1:09	1:35	3:50
	Use for loads with normal amounts of food soil.	The energy-usage label is based on this cycle. During the wash, the wash action will repeatedly pause for several seconds.	1:04	1:30	3:46
	Use for lightly soiled items or china and crystal.	During the wash, the wash action will repeatedly pause for several seconds.	0:47	1:13	2:56
	Use for rinsing		0:10	0:10	0:10

	dishes, glasses, and silverware that will not be washed right away	This cycle does not dry. Do not use detergent. During the wash, the wash action will repeatedly pause for several seconds.			
--	--	--	--	--	--







You can customize your cycle by selecting an option.

See option selections. If you change your mind, press the option again to turn off the option, or select a different option. You can change an option anytime before the selected option begins.

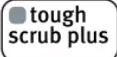
*Maximum wash times depend on water temperature, heavy soil condition, dish load size and options selected.



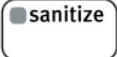

OPTION SELECTIONS

OPTIONS	DISH LOAD TYPES	DESCRIPTIONS	USE WITH:
	Use for loads with tough food soil.	Depending upon which cycle is being used, adds heat and/ or wash time to the cycle.	Heavy, Normal, & Auto Clean Plus cycles
	Loads containing tough, baked-on food.	Increases the target water temperature during the wash portions of the cycle. Adds heat, wash time and water to the cycle.	Heavy, Normal, & Auto Clean Plus cycles
Heated dry  	Heated dry: For best drying results, dry dishes with heat.	Turn OFF when loads contain plastic dinnerware that may be sensitive to high temperatures. This option with the use of rinse aid will provide the best drying performance.	Heavy, Normal, Light, or Auto Clean Plus
 	To sanitize your dishes and glassware in accordance with NSF/ANSI Standard 184 for Residential Dishwashers.	Raises the water temperature in the final rinse to approximately 154°F (68°C). This high temperature rinse sanitizes your dishes and glassware in accordance with NSF/ANSI Standard 184 for Residential Dishwashers. Certified residential dishwashers are not intended for licensed food establishments. The Sanitize option adds heat and time to the cycle.	Heavy, Normal, Light, or Auto Clean Plus
 2 4 6	To run your dishwasher at a later time or during offpeak hours.	Delays the start of a cycle up to 6 hours.	All cycles

		Select a wash cycle and options. Press Delay. Press START/RESUME. Close the door firmly within 3 seconds. For fully integrated models ((controls on top of console).	
Control Lock 	To avoid unintended use of your dishwasher, or cycle and option changes during a cycle.	To turn on Lock, press and hold Heated Dry for at least 3 seconds. To turn off Lock, press and hold Heated Dry for at least 3 seconds. When Control Lock is lit, all buttons are disabled. If you press any pad while your dishwasher is locked, the light flashes 5 times. The dishwasher door can be opened while the controls are locked.	Anytime

IMPORTANT: The sensor in your dishwasher monitors the soil level. Cycle time and/or water usage can vary as the sensor adjusts the cycle for the best wash performance. If the incoming water is less than the recommended temperature or food soils are heavy, the cycle will automatically compensate by adding time, heat and water as needed.

CONTROLS AND CYCLE STATUS

CONTROL	PURPOSE	COMMENTS
 ■ start resume	To start or resume a wash cycle	If the door is opened during a cycle or the power is interrupted, all lights will flash to indicate a suspended cycle. The cycle will not resume until the door is closed, and the START/RESUME button is pushed.
 ■ cancel drain	To cancel wash cycle	Close the door firmly. The dishwasher starts a 2-minute drain (if needed). Let the dishwasher drain completely
	To follow the progress and status of your dishwasher cycle	<p>The “Clean” indicator glows when a cycle is finished.</p> <p>If you select the Sanitize option, when the Sanitize cycle is finished, the Sanitized indicator glows. If your dishwasher did not properly sanitize your dishes, the light will be blinking. This can happen if the cycle is interrupted, or the water could not be heated to the required temperature. The clean and sanitize lights go off when the door has been opened for more than 30 seconds or the CANCEL key is pressed.</p> <p>The “Washing” indicator glows at the start of the first fill of any cycle (except Rinse Only) and remains on until the end of the main wash cycle.</p> <p>The “Drying” indicator glows during the drying portion of each cycle (except Rinse Only).</p>

Dishwasher Features

Your Maytag dishwasher may have some or all of these features.

Split & Fit™ Utensil Basket

The split silverware basket can be separated and placed in various locations in the lower rack. Load flatware and utensils into both sections or just one, depending on your load.

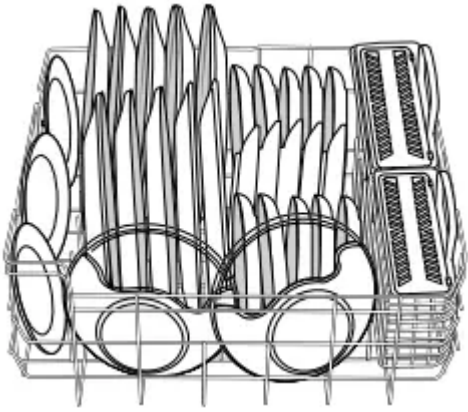

To split the basket:

Hold the basket firmly along the sides. Unlock the baskets.



Silverware basket lids:

Use silverware basket lids to provide optimal spacing and best cleaning performance.

Cup Clips

The Cup Clips located in the center of the upper rack can be used to hold lightweight plastic items, cooking utensils and knives in place. Clip the item between the tine and the clip.

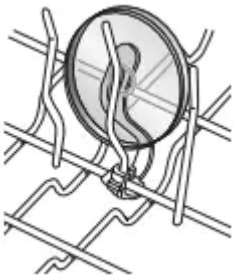

Stack-Rack

Fold down the extra shelf on the right-hand side of the upper rack to hold additional cups, stemware or long items such as utensils and spatulas.

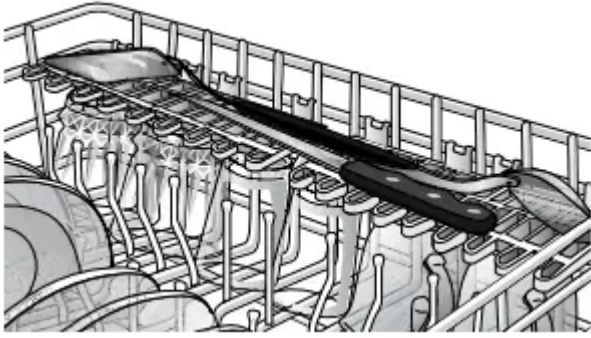

SilverWare Blast™

The SilverWare Blast is designed to focus cleaning power on your silverware.

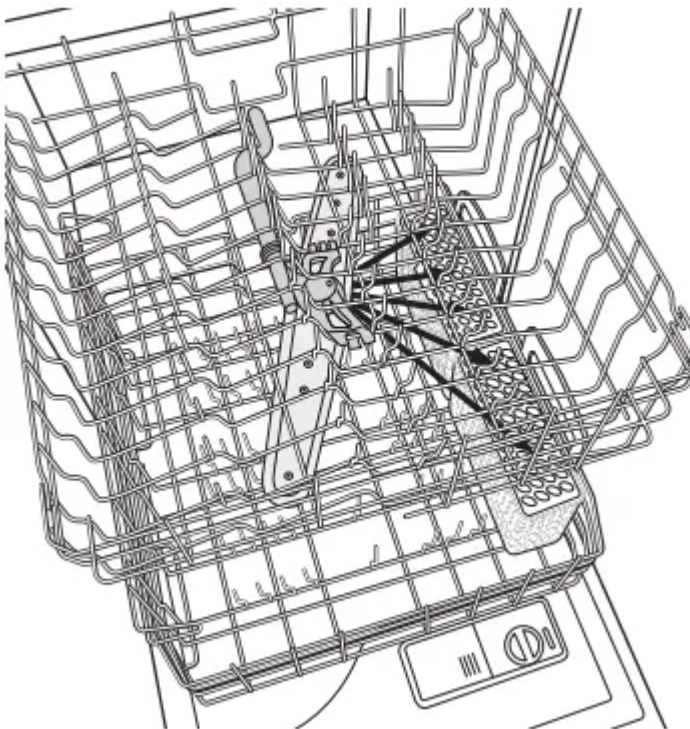

Removable Upper Rack

The removable rack allows you to wash larger items such as stock pots, roasters, and cookie sheets in the lower level rack.

IMPORTANT: Remove dishes prior to removing the upper rack from the dishwasher.

To remove the rack (push tab rack stop):

1. Roll the rack $\frac{1}{3}$ to $\frac{1}{2}$ of the way out.
2. Remove each plastic push tab rack stop from the end of each track by pushing inward toward the rack on the ridged area of the rack stop. The rack stop will snap open and can be easily removed by pulling straight out. Be sure to support the track while removing rack stops.

3. Roll the rack all the way out of the track and remove from the dishwasher.

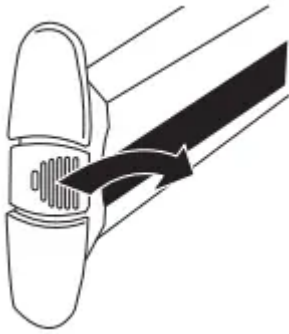

To replace the rack:

Reverse the above steps 1-3 to replace the rack into the dishwasher.

Portable Dishwashers (on some models)

WARNING: Electrical Shock Hazard

- Plug into a grounded 3 prong outlet.
- Do not remove ground prong.
- Do not use an adapter.
- Do not use an extension cord.
- Failure to follow these instructions can result in death, fire, or electrical shock.

Connecting the Faucet Adapter

NOTE: A special adapter must be installed on the faucet before the dishwasher can be connected. Complete Installation Instructions and the adapter are packed with your dishwasher.

When moving your dishwasher, make sure the door is latched. Hold the dishwasher at the top front corners.

Preparing the faucet

1. Remove the screen holder or aerator, screen, and washer from the end of the faucet.
2. Use the faucet adapter kit that came with your portable dishwasher to modify the faucet where the dishwasher will be used.

NOTE: Remove and save the washer, screen, and screen holder or aerator for future use.

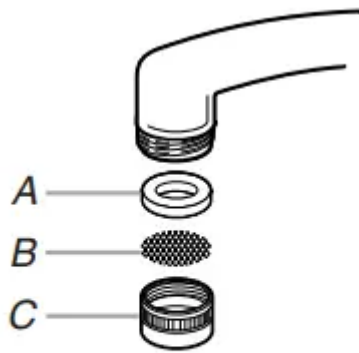

- A. Washer
- B. Screen
- C. Screen holder or aerator

Connecting the faucet adapter to faucets with external threads

Insert the 2 screens and then the thin washer from the faucet adapter kit into the faucet adapter. Attach the adapter onto the end of the faucet.

NOTE: Do not use the thick washer.

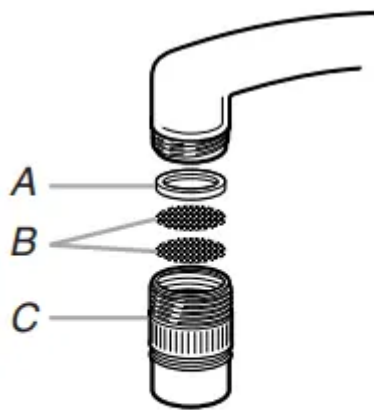

- A. Thin washer
- B. Screens
- C. Faucet adapter

Connecting the faucet adapter to faucets with internal threads

Insert the 2 screens, the thin washer, and then the thick washer from the faucet adapter kit into the faucet adapter. Attach the adapter onto the end of the faucet.

NOTE: Use both washers.

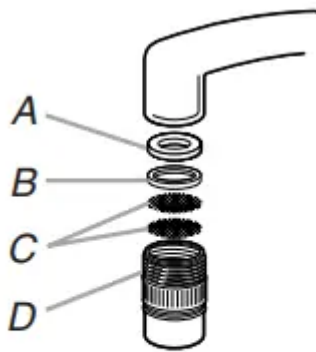

- A. Thick washer
- B. Thin washer
- C. Screens
- D. Faucet adapter

Connecting to Water and Electrical Supply

1. Run water at the faucet until it is hot. Turn off the water.
2. Pull the hoses out of their storage compartment on the back of the dishwasher.

NOTE: Make sure the hoses are not kinked or twisted. Kinked hoses reduce washing performance.

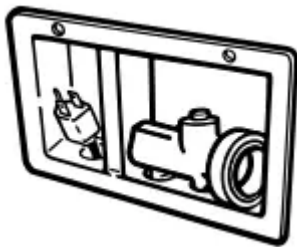

3. Pull down on the locking collar while lifting the hose connector onto the faucet adapter

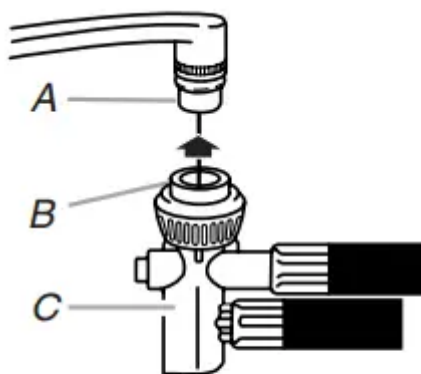

- A. Faucet adapter
- B. Locking collar
- C. Hose connector

4. When the connector snaps into place, release the locking collar.

5. Turn the hot water on slowly until it is all the way on.
6. Plug into a grounded 3 prong outlet.

Disconnecting the Dishwasher

1. Turn off the hot water. (This can be done after the last rinse.)
2. Press the red button on the connector to release the water pressure.

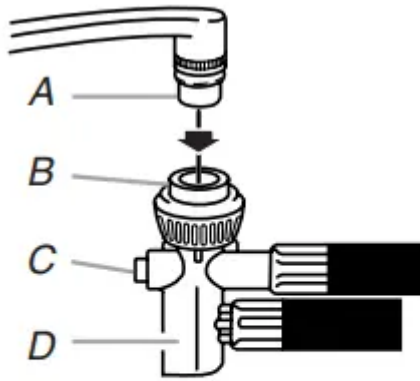

- A. Faucet adapter*
- B. Locking collar*
- C. Red button*
- D. Hose connector*

3. Lift slightly on the hose connector while pulling down the locking collar. Pull down on the connector.
4. Empty any remaining water from the connector by turning the connector upside down.
5. Unplug the power supply cord and return it to the storage compartment.
6. Return the hoses to the storage compartment.

Dishwasher Care

Cleaning the Dishwasher

Clean the exterior of the dishwasher with a soft, damp cloth and mild detergent. If your dishwasher has a stainless steel exterior, a stainless steel cleaner is recommended - Stainless Steel Cleaner and Polish Part Number 31462.

Clean the interior of the dishwasher, with a paste of powdered dishwasher detergent and water or use liquid dishwasher detergent on a damp sponge to clean the cooled-down interior.

A white vinegar rinse may remove white spots and film. Vinegar is an acid, and using it too often could damage your dishwasher.

Put 2 cups (500 mL) white vinegar in a glass or dishwasher-safe measuring cup on the bottom rack. Run the dishwasher through a complete washing cycle using an air-dry or an energy-saving dry option. Do not use detergent. Vinegar will mix with the wash water.

If you have a drain air gap, check and clean it if the dishwasher isn't draining well.

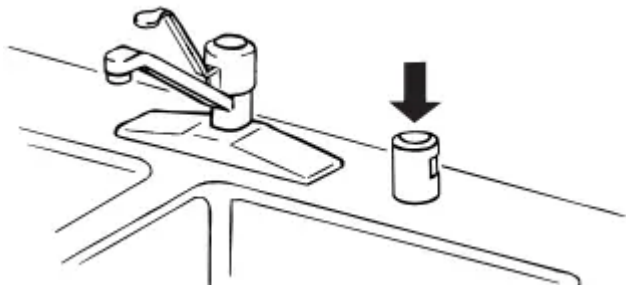

Storing the Dishwasher

If you will not be using the dishwasher during the summer months, turn off the water and power supply to the dishwasher. In the winter, if the dishwasher could be exposed to near freezing temperatures or is left in a seasonal dwelling such as a second home or vacation home, avoid water damage by having your dishwasher winterized by authorized service personnel.

Troubleshooting



PROBLEM	SOLUTION
<p>DISHWASHER DOES NOT RUN</p>	<p>NOTE: It is normal for the dishwasher to repeatedly pause several times during a cycle.</p> <p>If the START/RESUME light is blinking, press START/RESUME and close the door firmly within 3 seconds. For fully integrated models (controls on top of counter), press the START/RESUME button.</p> <p>Be sure the door is closed and latched.</p> <p>Be sure you have selected a cycle.</p> <p>Be sure there is power to the dishwasher. A circuit breaker or fuse may have tripped.</p> <p>If lights other than START/RESUME blink and the unit will not run, you will need to call for service.</p>
<p>DETERGENT REMAINS IN THE DISPENSER OR TABLET IS ON BOTTOM OF TUB</p>	<p>Check for dishware such as cookie sheets, cutting boards, or large containers that may be blocking the detergent dispenser from opening properly.</p> <p>Be sure your detergent is fresh and lump free.</p> <p>Be sure the cycle has completed (green light is on). If it has not completed, press START/RESUME to cancel the cycle.</p>
<p>CYCLE RUNS TOO LONG</p>	<p>NOTES:</p> <ul style="list-style-type: none"> - To use less water and reduce energy consumption you will encounter cycles that typically run for up to 3 hours. - A water heater setting of 120°F (49°C) is best. The dishwasher will delay heating cooler water. - Some options will add time to the cycle. The Heated Dry option adds ½ hour. <p>Try the Insta Wash cycle.</p> <p>Run the hot water at a faucet close to the dishwasher before starting the cycle.</p>
<p>DISHWASHER NOT DRYING</p>	<p>NOTE: Plastic and items with nonstick surfaces are difficult to dry because they are a porous surface which tends to collect water droplets. Towel drying may be necessary.</p> <p>Use of rinse aid along with the Heated Dry option is needed for proper drying.</p> <p>Use of the High Temp Wash option will improve drying results.</p> <p>Proper loading of items can affect drying.</p> <p>Glasses and cups with concave bottoms hold water. This water may spill over items when unloading.</p> <ul style="list-style-type: none"> - Unload the bottom rack first.

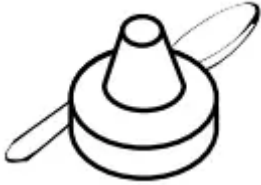

PROBLEM	SOLUTION
	<p>- Locate these items on the more slanted side of the rack for improved results.</p>
<p>WILL NOT FILL</p>	<p>Be sure the water is turned on to the dishwasher.</p> <p>Check that the float is free from obstructions.</p> <p>Check for suds in the dishwasher. If foam or suds are detected, the dishwasher will not operate properly or may not fill with water.</p> 
<p>WATER REMAINS IN THE TUB/ WILL NOT DRAIN</p>	<p>Be sure the cycle has completed (the green light is on). If the cycle has not completed, you will need to resume the cycle by pressing START/RESUME and closing the door within 3 seconds.</p> <p>If dishwasher is connected to a food waste disposer, be sure the knockout plug has been removed from the disposer inlet.</p> <p>Check for kinks in the drain hose.</p> <p>Check for food obstructions in the drain or disposer.</p> <p>Check your house fuse or circuit breaker.</p>
<p>HARD WATER (WHITE RESIDUE ON DISHWASHER INTERIOR OR GLASSWARE)</p>	<p>NOTE: Extremely hard water mineral deposits can cause damage to your dishwasher and make it difficult to achieve good cleaning. A water softener is strongly recommended if your hardness is 15 grains or more. If a water softener is not installed, the following steps may help:</p> <p>Use a commercial cleaner designed for dishwashers once per month.</p> <p>Always use a rinse aid.</p> <p>Always use a high-quality, fresh detergent.</p> <p>Use a detergent booster/water softener additive designed for dishwashers.</p>
<p>ODORS</p>	<p>NOTE: If the dishwasher is not used daily, you can run a rinse cycle with a small load daily until a full load is ready to run.</p>

PROBLEM	SOLUTION
	<p>Run a vinegar rinse through the dishwasher by putting 2 cups (500 mL) of vinegar in an upright glass measuring cup in the lower rack. Run a normal cycle with the Heated Dry option turned off. Do not use detergent.</p>
NOISY	<p>NOTES:</p> <ul style="list-style-type: none"> - Surging sounds can occur periodically throughout the cycle while the dishwasher is draining. - Normal water valve hissing may be heard periodically. - A normal snap sound may be heard when the detergent dispenser opens at the start of the cycle and when the door is opened at the end of the cycle. - Improper installation will affect noise levels. <p>Be sure the filters are properly installed.</p> <p>A thumping sound may be heard if items extend beyond the racks and into the wash arms. Readjust the dishware and resume the cycle.</p>
FOOD SOILS REMAIN ON DISHES	<p>Be sure the dishwasher is loaded correctly. Improper loading can greatly affect washing performance.</p> <p>Select the proper cycle and option for the type of soils. The Pots Pans cycle with the Hi Temp option can be used for tougher loads.</p> <p>Be sure the incoming water temperature is at least 120°F (49°C).</p> <p>Use the proper amount of fresh detergent. More detergent is needed for heavy loads and hard water conditions.</p> <p>Scrape food from dishes prior to loading (do not prerinse).</p>
DID NOT SANITIZE	<p>If the sanitized light is blinking, the load is <i>NOT</i> sanitized. The cycle was interrupted during the final rinse, or your water heater is set too low. Set your water heater to at least 120°F (49°C).</p>
DAMAGE TO DISHWARE	<p>Improper loading can cause dishes to become chipped or damaged.</p>
BLINKING LIGHTS	<p>If the START/RESUME light is blinking, press START/RESUME and close the door within 3 seconds. If the Clean light or any other lights are blinking and the cycle will not run, call for service.</p>



PROBLEM	SOLUTION
<p>CLOUDY OR SPOTTED DISHWARE (AND HARD WATER SOLUTION)</p>	<p>NOTES:</p> <ul style="list-style-type: none"> - Liquid rinse aid is necessary for drying and to reduce spotting. - Use the correct amount of detergent. <p>Confirm that the cloudiness is removable by soaking the item in white vinegar for 15-30 minutes. If the cloudiness disappears, it is due to hard water. Adjust the amount of detergent and rinse aid.</p> <p>Be sure the incoming water temperature is set at 120°F (49°C).</p> <p>Try using the Hi Temp and Sani Rinse options.</p> <p>To remove spotting, run a vinegar rinse through the dishwasher.</p> <ul style="list-style-type: none"> - Wash and rinse the affected dishware and load into dishwasher. Remove silverware and metal items. Put 2 cups (500 mL) of white vinegar in a glass cup in the lower rack. Run a normal cycle with the Heated Dry option turned on. If additional detergent is needed.
<p>ETCHING (PERMANENT CLOUDINESS)</p>	<p>This is an erosion of the surface of the glassware and can be caused by a combination of: water that is too hot, from using too much detergent with sudsing, or by pre-washing. Detergent needs food soil to act upon. If etching has occurred, the glassware is permanently damaged. To avoid further etching, adjust the detergent amount to match the water hardness, stop pre-washing, and use water heater options only when incoming water temperature is below 120°F (49°C).</p>
<p>LEAKING WATER</p>	<p>Be sure dishwasher has been installed properly and is level.</p> <p>Suds can cause the dishwasher to overflow. Measure the detergent accurately and use only detergents designed for use in a dishwasher. Less detergent is needed in soft water. Try another brand of detergent if sudsing continues.</p> <p>To avoid rinse aid leaking from the dispenser, be sure the lid is securely closed and avoid overfilling.</p>
<p>TUB IS DISCOLORED</p>	<p>NOTES:</p> <ul style="list-style-type: none"> - High iron content in the water can discolor the tub. - Tomato-based foods can discolor the tub or dishware. A citrus-based cleaner can be used to clean.



Warning

This content is compiled from multiple sources and is provided for reference purposes only. It may not be complete or fully applicable to all situations. If you are unable to resolve your issue, please contact the product manufacturer or an authorized service provider for official support.

Document generated by [ManualsFile](#)