

# Setting up your French Door Refrigerator

## GETTING READY TO INSTALL THE REFRIGERATOR

Congratulations on your purchase of the Samsung refrigerator. We hope you enjoy the state-of-art features and efficiencies that this new appliance offers.

### Selecting the best location for the Refrigerator

#### Choose :

- A location with easy access to a water supply.
- A location without direct exposure to sunlight.
- A location with level (or nearly level) flooring.
- A location with enough space for the refrigerator doors to open easily.
- A location that allows sufficient space to the right, left, back, and top for air circulation. If the refrigerator does not have enough space, it can cause the bad influence to refrigeration efficiency and power consumption.
- A location that allows you to move the refrigerator easily if it needs maintenance or service.
- Do not install the refrigerator in locations where the temperature is over 110 °F (43 °C) or below 50 °F (10 °C).

### Door Clearance

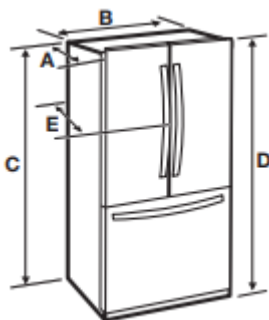

<b>Model</b>	<b>RF23HC**</b>
<b>Depth "A"</b>	28 1/2" (726 mm)
<b>Width "B"</b>	35 6/8" (908 mm)
<b>Height "C"</b>	68 7/8" (1749 mm)
<b>Overall Height "D"</b>	70" (1777 mm)
<b>Depth "E"</b>	31" (788 mm)

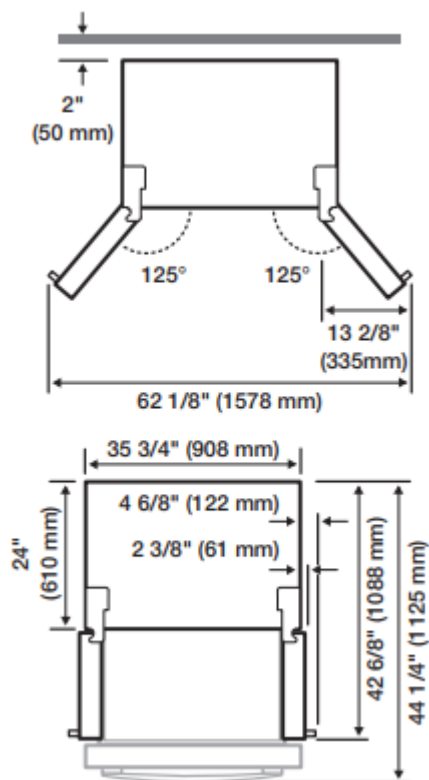

Each measurement based on the design dimension, so it may differ depending on the measuring method.

**CAUTION: When moving your refrigerator**

To prevent floor damage, be sure the front adjusting legs are in the up position (above the floor).

Refer to 'Leveling the Refrigerator' on page 16.



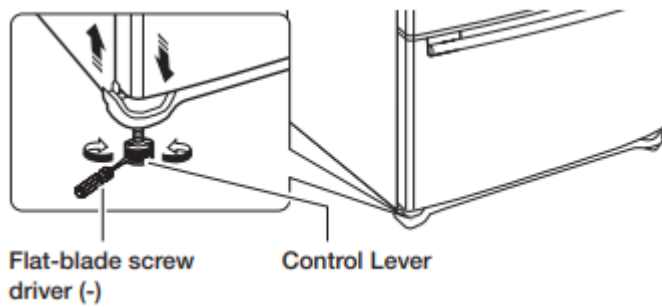

## Flooring

For proper installation, you must place this refrigerator on a level, hard surface that is the same height as the rest of the floor.

This surface should be strong enough to support a fully loaded refrigerator.

To protect the finish of the flooring, cut a large section of the cardboard carton and place it under the refrigerator where you are working.

When moving the refrigerator, you need to pull and push it straight forwards or back.

Do not wiggle it from side to side.

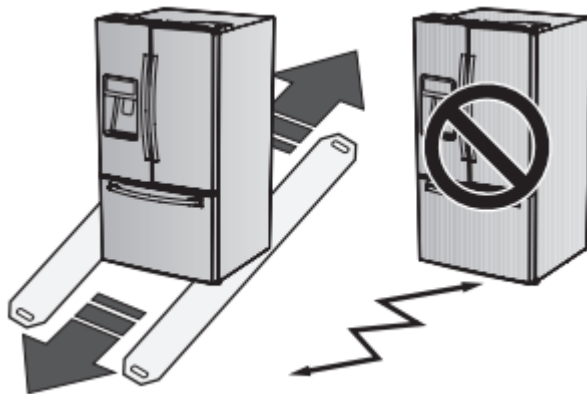

## REMOVING THE REFRIGERATOR DOORS

For some installations, you need to remove the fridge and freezer drawers so you can move the refrigerator to its final location.

Do not remove the doors/drawer if you don't need to. If you do not need to remove the refrigerator doors, go to 'Leveling the Refrigerator' on page 16.

If you need to remove the doors, continue below. Before removing the door/drawer, make sure you read the following items:

**WARNING:** Disconnect power to the refrigerator before removing the door or drawer.

- Be careful not to drop, damage or scratch the door / drawer while removing them.
- Be careful not to injure yourself while removing the doors / drawer.





- Reattach the door/drawer properly to avoid:
  - Moisture from air leakage.
  - Uneven door alignment.
  - Wasting energy due to improper door seal.

**WARNING: Disassembling the refrigerator doors**

Be careful not to drop and scratch the doors while removing them.

**Required Tools (Not provided)**

You need the following tools to complete the installation of your refrigerator:

		
Phillips screwdriver (+)	Flat-blade screw driver (-)	Socket wrench (13/32") (10 mm)
		
Pliers	Allen wrench (3/16") (5 mm)	

**With the door opened**

1. Remove 3 screws holding down the TOP TABLE ( 1 ) and separate the connected wires.

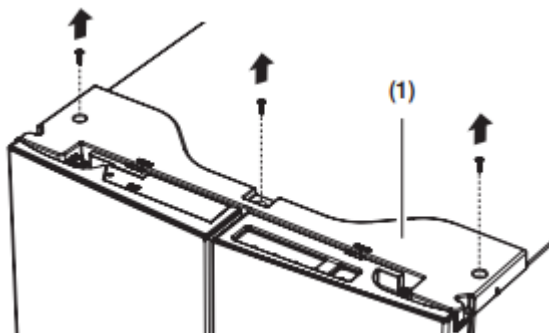

2. Disconnect two connectors ( 2 ) on the left side door. To remove the water coupler from the hinge, twist and pull it from the hinge. Remove the water line ( 3 ) while pressing the marked part ( 4 ) of the water line coupler.

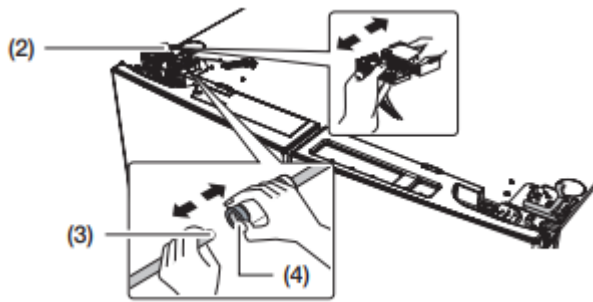

3. Pull and remove the hinge lever ( 5 ). Remove the ground screw ( 6 ) attached to the upper left door hinges with a philips screwdriver (+). Remove the upper left and right door hinges ( 7 ).

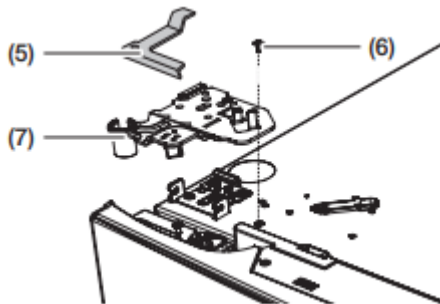

4. Lift the door straight up to remove.

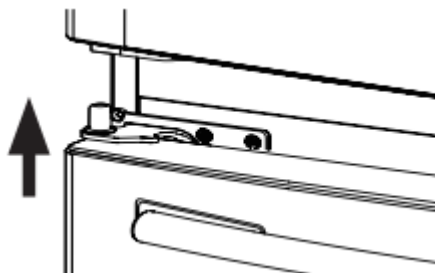

5. Remove the screw ( 8 ) attached to the lower left and right door hinges with a philips screwdriver (+).

Remove the 2 hex head bolts ( 9 ) attached to the lower left and right door hinges with an allen wrench (3/16").

Remove the lower left and right door hinges ( 10 ).

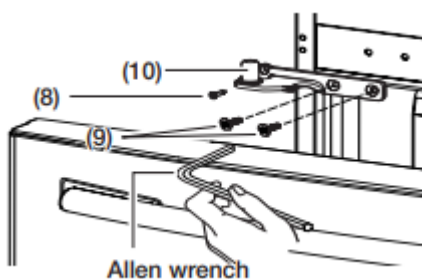

## RE-ATTACHING THE REFRIGERATOR DOORS

To reattach the fridge doors after you have moved the fridge to its final location, assemble the parts in reverse order.

1. The Water Line must be fully inserted into the center of the transparent coupler (Type A) or the Guide Lines (Type B) to prevent water leakage from the dispenser.

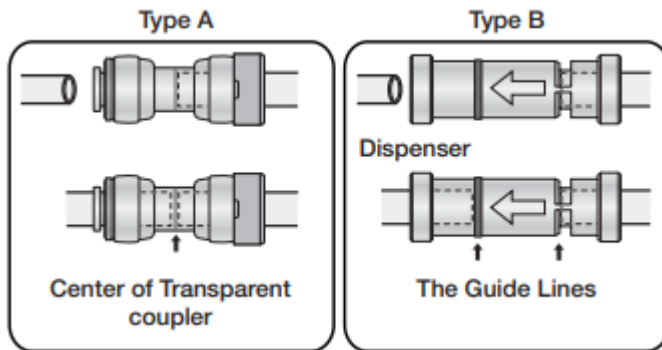

## DISASSEMBLE THE FREEZER DRAWER

1. Take out the upper drawer by lifting it up.

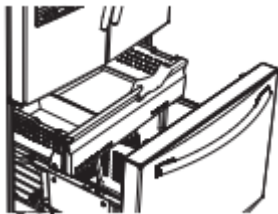

2. Remove the freeze room guard ( 1 ) by lifting the guard up.

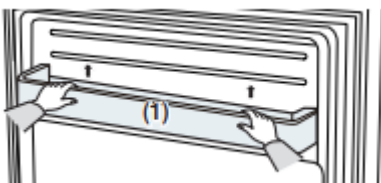

3. Take out the lower basket ( 2 ) by lifting the basket up from the rail system.

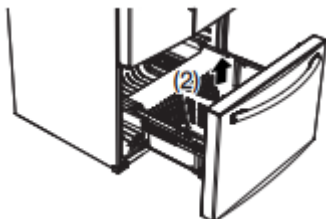

4. Press the fixing hook of the rail system

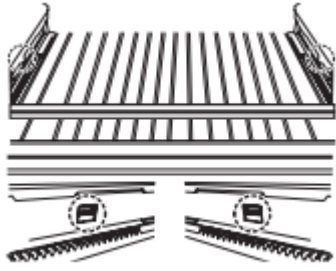

5. Holding the top of the Freezer Drawer, pull it out all the way, and then remove it from the rail system.

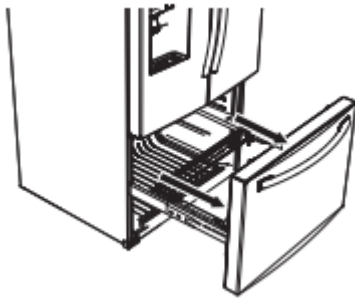

**CAUTION:** Be careful not to scratch or dent the sliding rail by letting it strike the floor.

**CAUTION:** Make sure that you mount the freezer basket in the right position when removing / installing the freezer door. Failing to do so may result in the door not opening or closing properly.

**CAUTION:** Putting too much food into the freezer drawers can prevent the freezer from closing completely and can cause frost build-up.

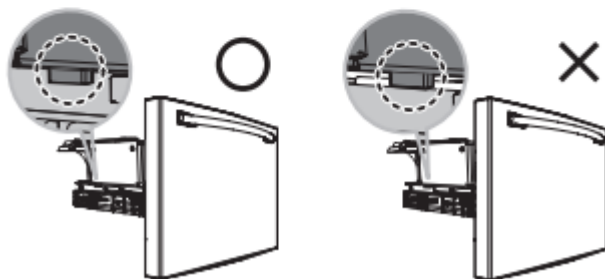
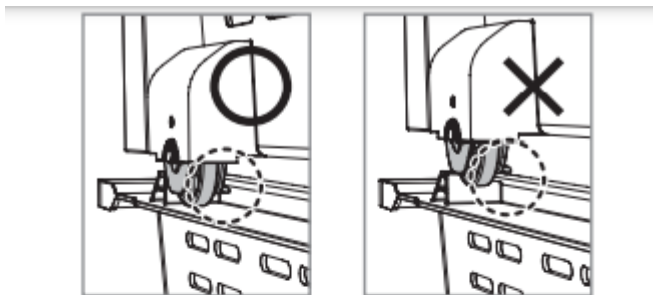

## RE-ASSEMBLE THE FREEZER DRAWER

To reattach the drawer after you have moved the fridge to its final location, assemble the parts in reverse order.

## LEVELING THE REFRIGERATOR

Make sure the refrigerator is level so that you can make final adjustments.

Use a level to test if the refrigerator is level both side to side and back to front.

If the refrigerator is not level, you will not be able to get the doors perfectly even, which may cause moisture condensation and increased energy bills. Below is an example of how to level the refrigerator if the left side of the refrigerator is lower than the right side.

### How to adjust the level

1. Open the freezer drawer and remove the lower basket.
2. Insert a flat-blade screwdriver (-) into a notch on the left control lever, and then turn it counterclockwise to level the refrigerator.

(You turn the lever clockwise to lower the refrigerator and counterclockwise to raise it.)

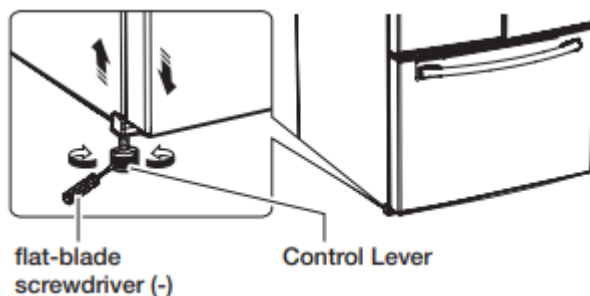

**CAUTION:** Both control levers must be touching the floor to avoid possible personal injury or property damage because of tipping.

If the right side is lower, perform the same procedure, but with the right control lever.

It is difficult to remove the cover leg front from the refrigerator, so we do not recommend making small adjustments with the control lever.

Instead, refer to the next page for the best way to make minor adjustments to the doors.

## MAKING MINOR ADJUSTMENTS BETWEEN DOORS

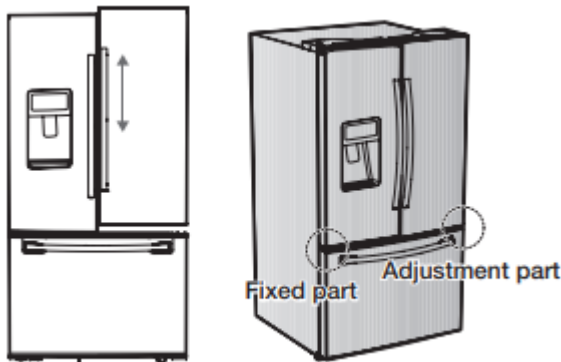

Remember, a leveled refrigerator is necessary for getting the doors perfectly even.

If you need help, review the previous section on leveling the refrigerator.



The left door is fixed.

To make minor adjustments between doors, adjust only the right door.

1. Pull out the freezer drawer ( **1** ) to reveal the lower hinge ( **2** ).
2. Insert a philips screwdriver (+) ( **3** ) into the shaft ( **4** ) of the lower hinge.
3. Adjust the height by turning a philips screwdriver (+) ( **3** ) clockwise (  ) or counterclockwise (  ).

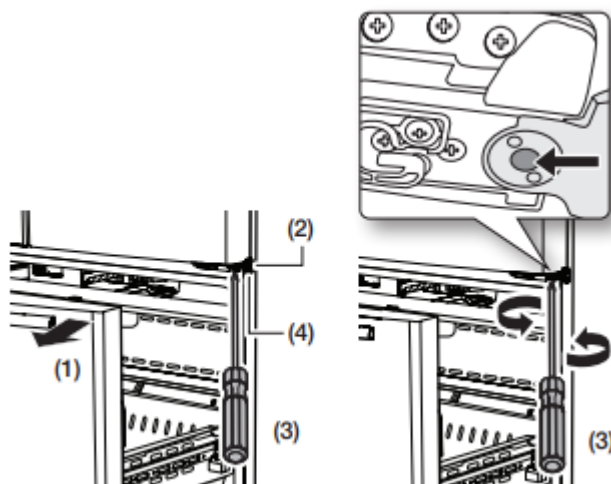

When you turn a philips screwdriver (+) counterclockwise (  ), the door will move up

## INSTALLING THE WATER DISPENSER LINE

A water dispenser with a filter is one of the helpful features on your new refrigerator.

To help promote better health, the water filter removes unwanted particles from your water. However, it does not sterilize the water or destroy microorganisms. You may need to purchase a water purifying system to do that.

The water line also connects to the ice maker. For the ice maker to operate properly, water pressure of 20 ~ 125 psi (138 ~ 862 kPa) is required.

If the refrigerator is installed in an area with low water pressure (below 20 psi), you can install a booster pump to compensate for the low pressure. After you have connected the water line, make sure the water storage tank inside the refrigerator is properly filled.

To do this, press the water dispenser lever until the water runs from the water outlet.

Water line installation kits are available at extra cost from your dealer.

We recommend using a water line installation kit that contains copper tubing and a ¼" compression nut.

### Connecting to the water supply line

1. First, shut off the main water supply.



2. Locate the nearest cold water drinking line and install the pipe clamp and shut off valve.

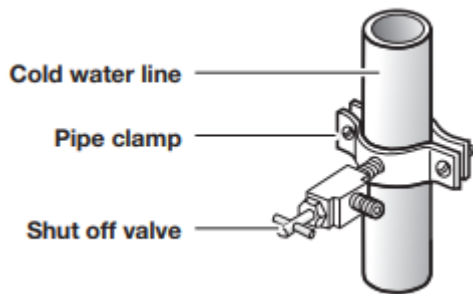

3. Connect the water line installation kit to the shut off valve.

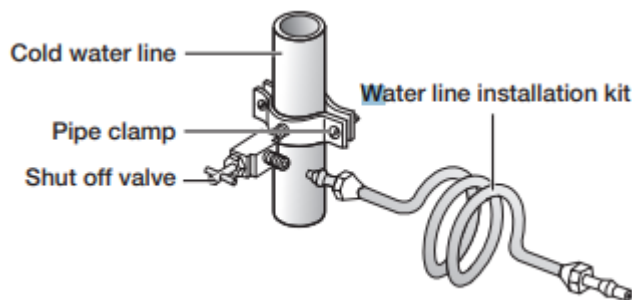

### Connecting the water supply line to the refrigerator

There are several items that you need to purchase to complete this connection.

You may find these items sold as a kit at your local hardware store.

Use Copper Tubing	Use Plastic Tubing
<ul style="list-style-type: none"> <li>• ¼" copper tubing</li> <li>• ¼" compression nut (1pc)</li> <li>• Ferrule (2pc)</li> </ul>	<ul style="list-style-type: none"> <li>• ¼" plastic tubing</li> <li>→ Molded end (Bulb)</li> <li>• ¼" compression nut (1pc)</li> </ul>

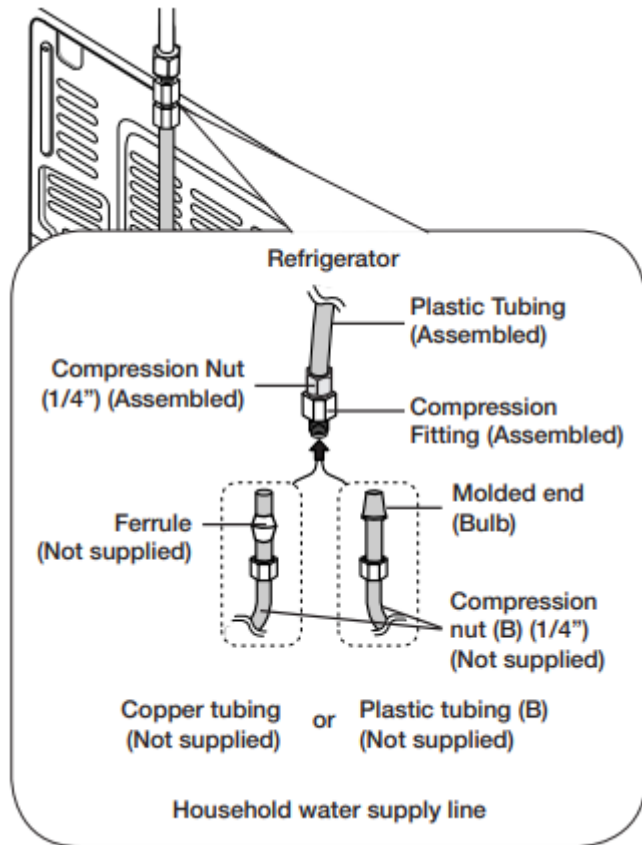

1. Connect the household water line to the assembled compression fitting.

- If you are using copper tubing, slip the compression nut ( **B** ) (not supplied) and ferrule (not supplied) on the copper tubing (not supplied) as shown.
- If you are using plastic tubing ( **B** ), insert the molded end (Bulb) of the plastic tubing ( **B** ) into the compression fitting.

**CAUTION:** Do not use without the molded end (Bulb) of the plastic tubing ( **B** ).

2. Tighten the compression nut ( **B** ) onto the compression fitting.

Do not over-tighten the compression nut ( **B** ).

3. Turn the water on and check for any leakage. If you find water drops or leakage in the connection areas, turn off the main water supply. Check the connections and, if necessary, tighten.

4. Flush 1 gallon of water through the filter before drinking or using the water from the refrigerator. (Flush approximately 6 minutes.)

To flush, press a large glass or cup against the water dispenser lever.

Fill the glass, empty it into the kitchen sink after it is filled, and then repeat.

5. After you turn on the refrigerator, let the ice maker make ice for 1 to 2 days.

Over that period of time, throw out the first 1 or 2 buckets of ice the freezer makes to ensure all impurities have been removed from the water line.

Only connect the water line to a drinkable water source.

If you have to repair or disassemble the water line, cut off 1/4" of the plastic tubing to make sure you get a snug, leak-free connection.

You can test the water line quickly using a paper cup. Under normal conditions, the water dispenser can fill a 5.75 oz. (170 cc) cup in about 10 seconds.

## COMPLETING THE SET UP

Now that you have your new refrigerator installed in place, you are ready to set up and enjoy the features and functions of the appliance.

By completing the following steps, your refrigerator should be fully operational.

1. Make sure your refrigerator is in an appropriate location with reasonable clearance between it and the wall. Refer to installation instructions in this manual.
2. Once the refrigerator is plugged in, make sure the interior light comes on when you open the doors.
3. Set the Temperature control to the coldest temperature and wait for an hour.

The freezer will get slightly chilled and the motor will run smoothly.

Reset the refrigerator and freezer to the temperatures you want.

4. After you plug the refrigerator in, it will take a few hours to reach the appropriate temperature.

You can store food and drinks in the refrigerator after the temperature is sufficiently cool.

If condensation or water drops appear on both sides of the fridge door's central part, turn the Energy Saver mode off after removing the condensation.

(See the explanation of the Energy Saver button in "Using the Control Panel" on page 21.)

## Operating your French Door Refrigerator

### USING THE CONTROL PANEL

RF23HCEDB\*

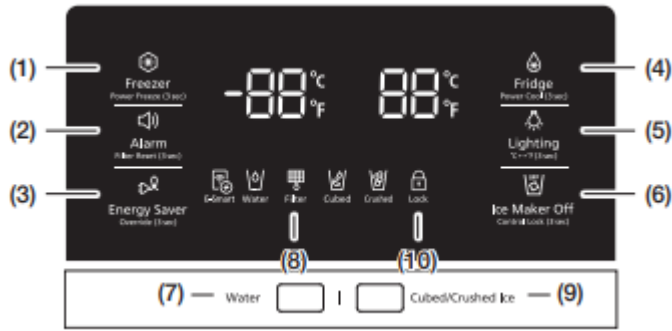

## RF23HCEDT\*

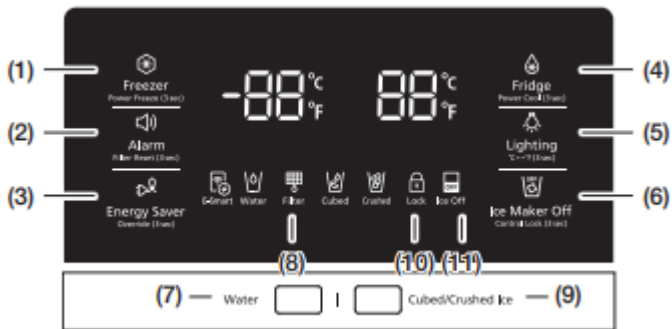

### ( 1 ) Freezer / Power Freeze (3sec)

The Freezer button serves two purposes:

- To set the Freezer to your desired temperature.
- To turn the Power Freeze function on and off.

1. To set the Freezer temperature, touch the Freezer button.

You can set the temperature between 5 °F (-15 °C) and -8 °F (-23 °C).

2. Power Freeze function

Touch and hold this button for 3 seconds to decrease the time needed to freeze products in the Freezer.

It can be helpful if you need to quickly freeze easily spoiled items or if the temperature in the freezer has warmed dramatically.

(For example, if the door was left open.) When you use this function, the energy consumption of the refrigerator will increase.

Remember to turn it off when you don't need it and return the freezer to your original temperature setting.

If you need to freeze a large amount of food, activate the Power Freeze function at least 24 hours before you put the food into the freezer.

### ( 2 ) Alarm / Filter Reset (3sec)

The Alarm button serves two purposes:

- To turn the door open alarm on and off
- To reset the water filter life indicator.

### 1. Door Alarm Function

If the door alarm is set to On, an alarm beeps if any refrigerator door is left open for more than three minutes.

The beeping stops when you close the door.

The door alarm function is pre-set to On in the factory.

You can turn it off by pressing and then releasing the Alarm button. You can turn it back on in the same fashion.

The icon lights up when the function is on. When the Door Alarm function is on and the alarm sound is triggered, the Door Alarm Icon will blink while the alarm sounds.

### 2. Water Filter Life Indicator Function

After you replace the water filter, touch and hold this button for 3 seconds to reset the water filter life indicator.

When you reset the water filter life indicator, the Filter icon on the panel turns Off.

The Filter icon will turn red to let you know it is time to change the water filter after six months (about 300 gallons).

Some areas have large amounts of lime in their water, which causes the water filter to clog more quickly.

If this is the case in your area, you will have to change the filter more frequently than every six months.

### ( 3 ) Energy Saver / Override (3sec)

The Energy Saver/Override (3sec) button serves two purposes:

- To turn the Energy Saver function on and off.
- To turn the Override function on and off.

#### 1. Energy Saver function

Touching this button turns Energy Saver mode on and off.

When you turn Energy Saver on, the Energy Saver icon lights.

Turn Energy Saver off and the icon goes off.

The Energy Saver function automatically turns on when power is supplied to the refrigerator.

If condensation or water drops appear on the doors, turn the Energy Saver mode off.

## 2. Override function

The Override function activates/deactivates Smart Grid (page 25). Press the Energy Saver/Override button for 3 seconds to set/clear the Override function.

### **( 4 ) Fridge / Power Cool (3sec)**

The Fridge button serves two purposes:

- To set the Fridge to your desired temperature.
- To turn the Power Cool function on and off.

#### 1. To set the Fridge temperature, press the Fridge button.

You can set the temperature between 44 °F (7 °C) and 34 °F (1 °C).

#### 2. Power Cool function

Touch and hold this button for 3 seconds to decrease the time needed to cool products in the Refrigerator.

It can be helpful if you need to quickly cool easily spoiled items or if the temperature in the fridge has warmed dramatically.

(for example, if the door was left open)

### **( 5 ) Lighting / °C ↔ °F (3sec)**

The Lighting button serves two purposes:

- To turn the dispenser light on and off
- To switch the temperature units between °C and °F.

#### 1. Light Function

Touching the Lighting button turns on the Dispenser LED lamp in continuous mode so that it stays on continuously.

The button also lights up.

If you want the Dispenser lamp to come on only when someone uses the dispenser, press the Lighting button to turn the continuous mode off.

#### 2. To switch the temperature units between °C and °F.

Touch and hold this button for 3 seconds to select the temperature display you want. Each time you press and hold the button, the °C and °F temperature modes alternate and the °C or °F icon lights up, indicating your selection.



### **( 6 ), ( 11 ) Ice Maker Off**

If you don't want to make more ice, touch the Ice Maker Off button.

The icon will light up and the Ice-Maker stops making ice.

**We recommend you to stop ice making if the following occur:**

- There is enough ice in the ice bucket.
- You want to save water and energy.
- Water is not being supplied to the refrigerator.

If the ice maker function is ON, and the water Line is not connected, there will be a water valve noise from the back of the unit. Press the Ice Maker Off (Control Lock (3sec)) button for less than 3 seconds until the Ice Off Indicator (   ) illuminates.

**( 7 ) Water**

Touch this button to dispense water.

This mode can not be used with the Ice Type mode simultaneously.

Water mode shuts off when you touch the Cubed / Crushed Ice button.

**To save electricity, the Panel Display turns off automatically under the following conditions: When no button has been pressed, when no doors are open, or when no Dispenser Lever has been pushed.**

**However, the icon indicating your cubed or crushed ice selection, will stay on.**

**When you press a button, open a door, or push a Dispenser Lever, the Panel Display will turn on again.**

**Except for the Water, and Cubed / Crushed Ice buttons, all function buttons will become operational after you remove your finger from the button you are currently pressing.**

**( 8 ) Filter**

**Water filter usage**

This icon lights up when you need to change the filter, usually after the refrigerator has dispensed about 300 gallons of water (after about 6 months). The icon will blink red for several seconds when you open or close the door.

After you install the new water filter, reset the filter indicator by touching and holding the Hold 3sec for Filter Reset button for 3 seconds.

- If water is not dispensing or dispensing slowly, you need to replace the water filter because the water filter is clogged.
- Some areas have large amounts of lime in their water, which causes the water filter to clog more quickly

**( 9 ) Ice Type**

Touch this button to select your desired ice type.

Cubed and crushed ice modes alternate when you press the button.

This mode can not be used with the Water mode simultaneously.

### **( 10 ) Ice Maker Off / Control Lock (3sec)**

The Ice Maker Off button serves two purposes:

- To turn the Ice maker on and off
- To turn the Control Lock Function on and off.

#### **1. Ice Off Function**

If you don't want to make more ice, press the Ice Maker Off button.

#### **2. Control Lock Function**

Touch and hold this button for 3 seconds to lock the display and the dispenser buttons so the buttons can not be used. When Control Lock is on, the refrigerator does not dispense ice or water, even if the Dispenser Lever is pressed.

The Control Lock icon lights up to indicate you've activated the Control Lock function. Press 3 seconds to unlock.

### **Cooling Off Mode**

Cooling Off mode (also called Shop mode), is designed for use by retailers when they are displaying refrigerators on the shop floor.

In Cooling Off mode, the refrigerator's fan motor and lights work normally, but the compressors do not run, and the refrigerator and freezer do not get cold. To start Cooling Off mode, touch and hold the Freezer, Fridge and Alarm buttons for 5 seconds during normal operation.

The refrigerator chime sounds and the temperature display flashes OFF.

To cancel Cooling Off mode, touch and hold the Freezer, Fridge and Alarm buttons again for 5 seconds.

### **E-Smart**

The E-Smart icon lets you check the status of the refrigerator's AP connection (network connection).

- When connected to an AP: The E-Smart icon is on.
- When not connected to an AP: The E-Smart icon is off

### **E-SMART Refrigerator Features**

How to get the most out of your E-Smart refrigerator.

## Getting Connected

To use the Smart Grid (Demand Response) and E-Smart function on your Refrigerator, you need the following devices and apps:

- Devices: 1) Wireless Router, 2) Samsung E-Smart Refrigerator, 3) Smartphone (Recommended: Galaxy S4, Galaxy Note3/ Android OS Jelly bean).
- Applications: 1) "Samsung E-Smart App" from the Google Play Store or Samsung Apps.

In addition, you need to:

- Connect the Refrigerator and the Smartphone to the same Wi-Fi network in your home.
- Install and run Samsung E-Smart App on your Smartphone (to use the Samsung E-Smart function).

In addition, to use the Smart Grid (Demand Response) function, you must Register for the service with your electric company.

The company must have an EMS (Energy Management System) that supports SEP (Smart Energy profile).

## Downloading the E-Smart App and Connecting the Refrigerator to your Network

1. On your Smartphone, connect to the app store (e.g. Google Play, etc.).
2. Search for the app using "Samsung E-Smart Ref." as the keyword.
3. Download the app and install it on your phone.
4. Launch the app. The network configuration screen appears.
5. Configure the AP information (SSID, Password, etc.) on the app screen.
6. Configure the network settings according to the instructions in the app.
7. On the refrigerator, press and hold the Fridge and Energy Saver buttons at the same time for 3 seconds. The refrigerator enters the AP mode.

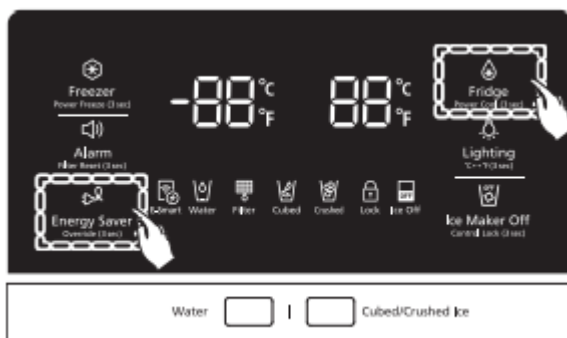

**8.** If you have completed the network settings properly, the app shows the home screen.

- Please confirm your the Internet devices (AP, Smartphone) are working properly before configuring the network settings.

- This refrigerator supports the IEEE 802.11 a/b/g/n protocols.

Samsung Electronics recommends IEEE 802.11n.

- To connect the refrigerator to a wireless network, you have to connect the refrigerator to an AP (router or modem).

If the AP supports DHCP, you can connect the refrigerator to the Internet using DHCP or a fixed IP address.

- Set the channel of the AP to one not currently being used.

If the channel set for the AP is being used by another device nearby, it may result in interference.

- Most wireless networks allow you to configure network security settings.

If your network has a security password, you must enter the password to connect to the network.

- The refrigerator supports the following wireless security modes and encryption types:

- Security Mode: WEP, WPAPSK, WPA2PSK

- Encryption Type: WEP, TKIP, AES (WPA2PSK and AES are recommended.)

- The app supports indoor control only.

- The Samsung E-Smart Ref. app is optimized for Samsung Electronics Smartphones (Galaxy S4 , Galaxy Note 3).

For other Smartphones, some functions may work differently.

## **MAC Address Display Mode**

This function displays the MAC address of the WiFi module on the refrigerator display.

The refrigerator displays the MAC address of the Wi-Fi module for 1 minute.

**1.** Press and hold the Freezer and Energy Saver buttons at the same time for 3 seconds.

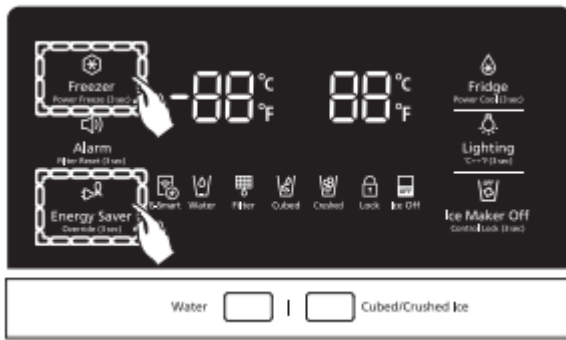

2. A Buzzer sounds. Four of the twelve Mac address of the Wi-Fi module are displayed in turns in the freezer and fridge temperature displays for 1 minute.

For example, if the Wi-Fi module's MAC address is "11-22-33-44-55-66", the MAC address is displayed as follows: "11 22" → "33 44" → "55 66" → ---- → "11 22" for 1 minute.

3. After 1 minute, the display returns to the normal state and the Buzzer sounds again.

If the Mac addresses are not available or there is no Wi-Fi module, '----' is displayed on the freezer and fridge temperature displays.

### SMART GRID Function (Demand Response)

When the refrigerator operates in SMART GRID (Demand Response) mode, the E-Smart Refrigerator function can control energy usage or delay the operation of some functions to save money when energy prices or demand are the highest,

**You can deactivate the SMART GRID (Demand Response) function at any time. (Using the Override On/Off function)**

**To use the SMART GRID (Demand Response) function, you need a separate contract with your electric Utility company.**

### Using the SMART GRID (Demand Response) Function

This feature monitors energy prices and demand information from your utility company and sends notifications to the refrigerator to run high energyconsuming tasks during off-peak times when electricity costs and demand are lower.

If the refrigerator receives a control signal from the Utility Company, the refrigerator will display the DAL(L3) ~ TALR(L4) levels on the refrigerator display and control the power consumption according to the level.

[Exception condition] The DAL and TALR control signals from an Utility Company work as long as product performance is maintained.

If the refrigerator receives the SMART GRID (Demand Response) signal (DAL or TALR), the refrigerator will operate in Delay Appliance Load (Display:L3) or Temporary Appliance Load Reduction (Display:L4) mode.

- Delay Appliance Load (L3): The refrigerator responds to a DAL signal by providing a moderate load reduction for the duration of the delay period.

This function controls functions that consume a lot of energy such as adjusting the Cooling system, running the defrost cycle, and making ice.

- When the refrigerator operates in DAL (L3) mode, "L3" is displayed on the refrigerator display.

- DAL mode is automatically deactivated after it lasts for the amount of time stipulated by the DAL signal (max. 4.5 hours) or when the Override key is pressed.

- Temporary Appliance Load Reduction (L4): The refrigerator responds to a TALR signal by aggressively reducing the load for a short time period.

This function reduces energy consumption by stopping the compressor and controlling the functions that consume a lot of energy such as the defrost cycle and making ice.)

- When the refrigerator operates in TALR (L4) mode, "L4" is displayed on the refrigerator display.

- TALR (L4) mode is automatically deactivated after it lasts for the received duration (max. 15 minutes), or when the Override key is pressed. The mode is immediately deactivated and the refrigerator returns to the normal state when the door is opened or closed, or the dispenser is used.

## Override Mode

When you want the refrigerator to ignore the SMART GRID (Demand Response) signal from the Utility Company, you can activate OVERRIDE mode.

When you activate OVERRIDE mode, the refrigerator ignores the SMART GRID (Demand Response) signal and is not controlled by the Utility Company

## Activating and deactivating Override mode

1. Press and hold the [Energy Saver] button for 3 seconds

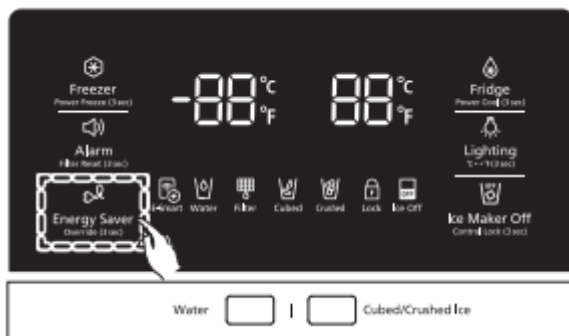

2. A buzzer sounds and `Or` and `on` is displayed in the freezer and fridge temperature displays for 5 seconds.
3. If the refrigerator receives a SMART GRID (Demand Response) signal from the Utility Company, `Or` is displayed in the freezer temperature display.
4. To deactivate OVERRIDE mode, press and hold the [Energy Saver] button for 3 seconds.

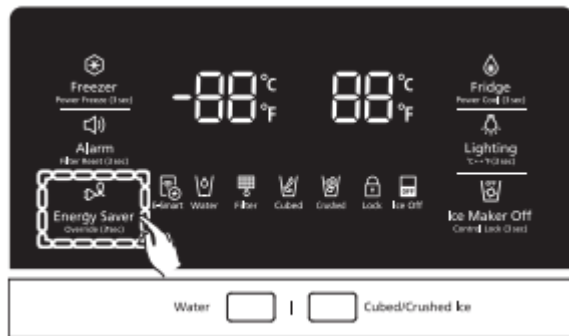

5. A Buzzer sound is played and 'Or' and 'oF' is displayed in the freezer and fridge temperature displays for 5 seconds.

Alternatively, you can activate or deactivate OVERRIDE mode using the app.

## Using the E-SMART Function

The E-SMART function enables you to control and monitor your E-Smart refrigerator remotely for your convenience.

- To use the E-SMART refrigerator functions, you have to install the corresponding app first.
- The app supports indoor control only.

### 1. Operational Status, User Settings & Messages

- You can view the freezer and fridge temperature settings.
- You can receive an alarm when the freezer or fridge door is open for 3 minutes.
- You can check the DR and Override status.
- You can check the operational condition of the ice maker in the freezer.

### 2. Remote Management

- Power Freeze Setting: You can remotely activate the Power Freeze function.
- Power Cool Setting: You can remotely activate the Power Cool function.
- Ice On/Off Setting: You can remotely set up the Ice On/Off Setting function.

You can only control the Ice maker in the Fridge remotely.

### 3. Energy Consumption Reporting

- Shows the accumulated power consumption. Power consumption data is updated every 10 minutes.

The energy consumption report may differ from the power consumption specifications of the product depending on the operating environment and the stored food.

### 4. Delay Defrost Capability

- The Delay Defrost Capability function saves energy by delaying the defrost operation to a time specified by the user.

You can configure the time, and this function will save energy during the specified period in a 24-hour cycle.

If the time is not set, the function works with the default time settings.

The default time settings are below:

- 6 am to 10 am: 1st. November ~ 30th. April
- 3 pm to 7 pm: 1st. May ~ 31th. October

### To change the time setting for the Delay Defrost Capability

You can change the time setting for the Delay Defrost Capability on the app.

### Provision for Open Access to the Connected Product Requirements

#### 1. SGIP Open Standards (Smart Energy Profile 2.0 - <http://www.csep.org/>)

- Energy Consumption Reporting
- Demand Response

#### 2. Samsung OPEN API

- Operational Status, User Settings & Messages
- ICE Maker Status: GET /external/ icestatus?icegetstatus=opt (relevant to the energy consumption of the product 1)
- Door Open Alarm: GET /devices/0/ Door?type=opt (relevant to the energy consumption of the product 2)
- DR Status: GET /external/drlc?drgetstatus=opt
  - Delay Defrost Capability
- Set Schedule of the Defrost Delay: POST / devices/0/defrost/addSchedule
- Get Schedule of the Defrost Delay : GET / devices/0/defrost/getSchedule
- Delete Schedule of the Defrost Delay: POST / devices/0/defrost/delSchedule

- Defrost Delay On/OFF: PUT /devices/0/defrost/ delayevent

## CHANGING THE WATER FILTER

**WARNING:** To reduce risk of water damage to your property DO NOT use generic brands of water filters in your SAMSUNG Refrigerator.

USE ONLY SAMSUNG BRAND WATER FILTERS. SAMSUNG is not legally responsible for any damage, including, but not limited to, property damage caused by water leakage from the use of a generic water filter.



(Red)

SAMSUNG Refrigerators are designed to work ONLY WITH SAMSUNG Water Filters.

The Filter light turns red to let you know when it is time to change your water filter cartridge.

To give you time to get a new filter, the red light comes on just before the capacity of the current filter runs out.

Changing the filter on time provides you with the freshest, cleanest water from your refrigerator.

1. Shut off the water supply. Then, turn the water filter ( **1** ) about 1/4 turn, counter-clockwise.
2. Pull the water filter ( **1** ) from the case filter ( **2** ).

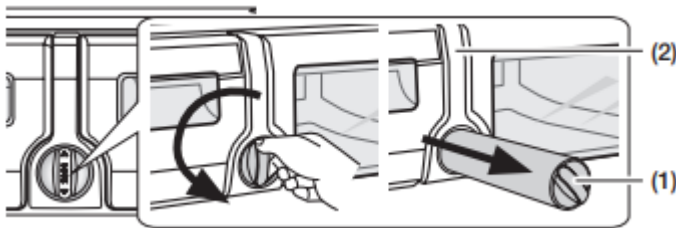

- To change the water filter more easily, shut off the water supply valve.
- Sometimes, it is hard to disassemble the water filter because impurities in the water cause it to stick. If you are having difficulties, grip the water filter firmly and pull it hard.
- When you pull the water filter, a little water can leak from the opening. This is normal. To minimize the water leaks, keep the filter cartridge horizontal when you pull it.
- To prevent overflow, empty the water filter tray ( **3** ) and dry around the filter case ( **2** ).

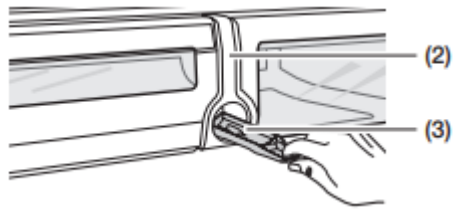

3. Insert the new filter into the filter case ( 4 ).

4. Push the filter, and then turn it clockwise until it locks.

- If you have trouble inserting the water filter because of high water pressure, shut off the water supply valve.
- The locked symbol should be lined up with the indicator line.

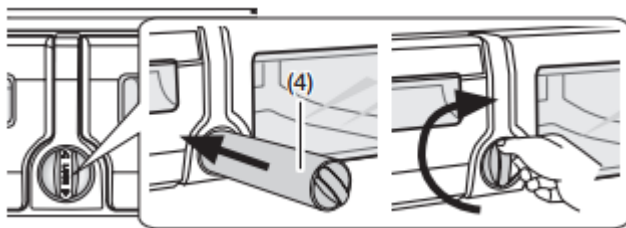

5. Touch and hold the “Alarm / Filter Reset” button for about 3 seconds to reset the water filter indicator.

The indicator’s red light will turn off.

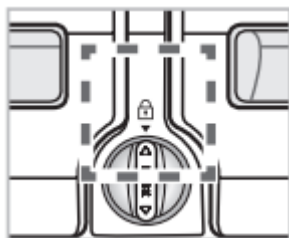

6. If you turned off the water supply, turn it back on.

For a replacement water filter, visit your local home Improvement center or visit Samsung’s parts distributor on line at: <http://www.samsungparts.com>

Be sure the replacement water filter has the SAMSUNG logo on the box and on the water filter.

### **Removing any residual matter inside the water supply line after installing the water filter.**

1. Turn ON the water supply if you turned it off when you installed the water filter.
2. Run water through the dispenser until the water runs clear (approx. 6 to 7 minutes). This will clean the water supply system and remove air from the lines.

3. Additional flushing may be required in some households.
4. Open the Refrigerator door and make sure there are no water leaks coming from the water filter.

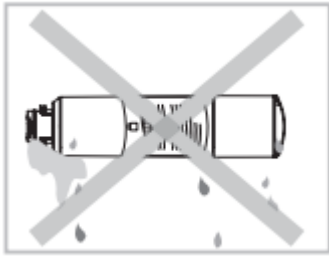

Be sure to flush the dispenser thoroughly, otherwise water may drip from the dispenser.

This means that there is still air in the line.

## Reverse Osmosis Water Supply

**IMPORTANT:** The pressure of the water supply coming out of a reverse osmosis system going to the water inlet valve of the refrigerator needs to be between 35 and 120 psi. (241 and 827 kPa)

If a reverse osmosis water filtration system is connected to your cold water supply, the water pressure to the reverse osmosis system needs to be a minimum of 40 to 60 psi. (276 to 414 kPa)

If the water pressure to the reverse osmosis system is less than 40 to 60 psi (276 to 414 kPa):

- Check if the sediment filter in the reverse osmosis system is blocked.

Replace the filter if necessary.

- Allow the storage tank on the reverse osmosis system to refill after heavy usage.
- If your refrigerator has a water filter, it may further reduce the water pressure when used in conjunction with a reverse osmosis system. Remove the water filter.

If you have questions about your water pressure, call a licensed, qualified plumber.

## CONTROLLING THE TEMPERATURE

### Basic temperature of Freezer and fridge compartments

The basic and recommended temperatures of the Freezer and Fridge compartments are 0 °F and 37 °F (or -18 °C and 3 °C) respectively.

If the temperature of the Freezer and Fridge compartments are too high or low, adjust the temperature manually. Controlling the Freezer temperature

## Controlling the Freezer temperature

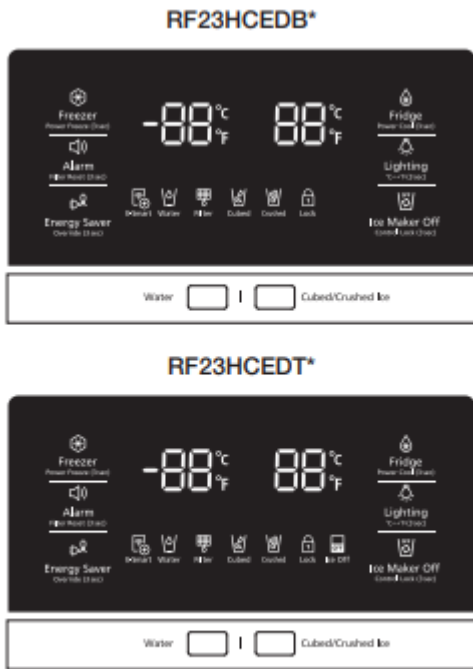

**Recommend Temp (Freezer) : 0 °F (or -18 °C)**

The Freezer temperature can be set between -8 °F and 5 °F (or between -23 °C and -15 °C) to suit your particular needs.

Press the Freezer button repeatedly until the desired temperature is shown in the temperature display.

The temperature will change by 1 °F (or 1 °C) with each press. See below.

Fahrenheit : 0 °F → -1 °F → -2 °F → -3 °F → -4 °F → -5 °F → -6 °F → -7 °F → -8 °F → 5 °F → 4 °F → 3 °F → 2 °F → 1 °F → 0 °F.

Centigrade : -18 °C → -19 °C → -20 °C → -21 °C → -22 °C → -23 °C → -15 °C → -16 °C → -17 °C → -18 °C.

Keep in mind that foods such as ice cream may melt at 4 °F (or -15.5 °C).

The temperature display will move sequentially from -8 °F to 5 °F (or from -23 °C to -15 °C).

## Controlling the fridge temperature

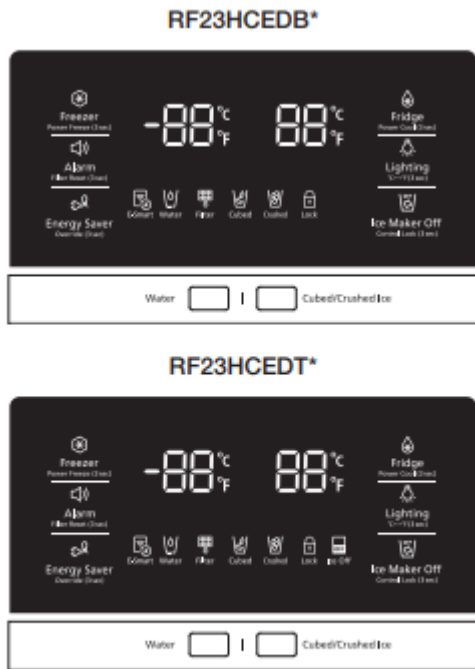

**Recommend Temp (Fridge) : 37 °F (or 3 °C)**

The fridge temperature can be set between 34 °F and 44 °F (or between 1 °C and 7 °C) to suit your particular needs.

Press the Fridge button repeatedly until the desired temperature is shown in the temperature display. The temperature will change by 1 °F (or 1 °C) with each press. See below.

Fahrenheit : 37 °F → 36 °F → 35 °F → 34 °F → 44 °F → 43 °F → 42 °F → 41 °F → 40 °F → 39 °F → 38 °F → 37 °F.

Centigrade : 3 °C → 2 °C → 1 °C → 7 °C → 6 °C → 5 °C → 4 °C → 3 °C.

The temperature control process for the Fridge works just like the Freezer process.

Press the Fridge button to set your desired temperature.

After a few seconds, the Fridge will begin adjusting towards the newly set temperature.

This will be reflected in the digital display.

- The temperature of the Freezer or Fridge may rise when you open the doors too frequently, or if a large amount of warm or hot food is placed inside.
- A rise in temperature may cause the digital display to blink.

Once the Freezer and Fridge temperature return to their normal set temperatures, the blinking will stop.

- If the blinking continues, you may need to “reset” the Refrigerator.

Try unplugging the appliance, wait for around 10 minutes and then plug the power cord back in.

- If there is a communication error between the Display and Main Controller, the Convertible Display light may blink.

If the blinking continues for a long period of time, please contact a Samsung Electronics Service Center.

## USING THE COLD WATER DISPENSER

Push the appropriate ice type button to select what you want dispensed.

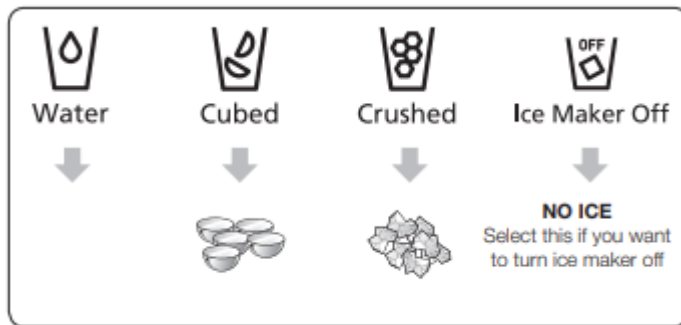

## Using the ice Dispenser

Place a glass underneath the ice dispenser and push gently against the dispenser lever with your glass. Make sure the glass is in line with the dispenser to prevent the ice from bouncing out.



- To select water, press the water button on the display, and then press the dispenser lever.
- To select Ice, press the ICE type button of your choice on the display, and then press the dispenser lever.
- If you have selected cubed ice, when you press the lever, the dispenser may dispense a small amount of crushed ice first.
- If ice doesn't come out, pull out the ice bucket and press the test button located on the right side of ice maker.

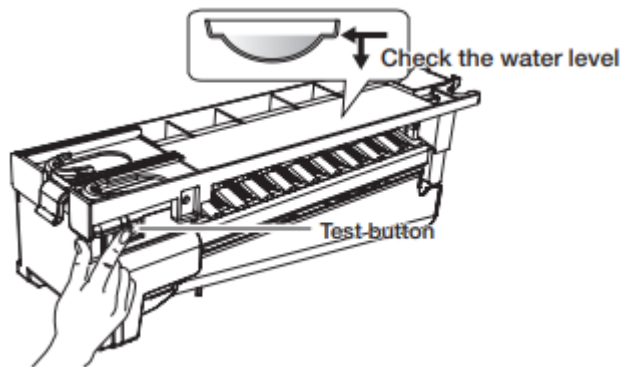

- Do not press the test button continuously when the tray is filled with ice or water. Water may overflow or ice may jam the bucket.
- When you press the Test button, you will hear the refrigerator chime (ding-dong). When the chime sounds, release the Test button.
- The chime sounds automatically again to let you know the ice maker is working well.
- Replace the ice bucket.

## Ice Making

To fill the ice bucket to maximum capacity after installation, follow these steps:

1. Allow your refrigerator to operate and cool down for 24 hours (or 1 full day).
  - Waiting 24 hours will allow your ice maker to cool properly.
2. Dispense 4 to 6 ice cubes into a glass.
3. After 8, and then 16 hours, dispense a full glass of ice.

## CAUTION

- To clean the ice bin/bucket, wash with a mild detergent, rinse well, and then dry it thoroughly. Do not use harsh or abrasive cleaners or solvents.
- When you select Cubed Ice after using the Crushed Ice mode, a small amount of residual crushed ice might be produced.

## If There is a Power Failure

If a power failure occurs, ice cubes may melt, and then freeze together when the power comes back on, preventing the dispenser from working properly.

To prevent this problem, after a power failure, pull out the ice bucket and discard the residual ice or water.

After you dump the ice from the ice bucket, you should press the dispenser lever once with the 'Water' or 'Ice Type' function ON.

The ice maker will make new ice faster after you return the ice bucket to the refrigerator.

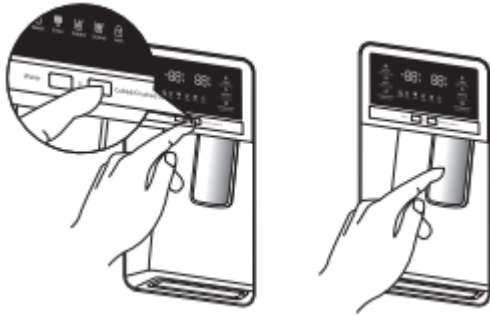

If you use all the ice at once, you must repeat Steps 2 and 3 under Ice Making. However, only wait 8 hours before dispensing the first 4 to 6 ice cubes. This will replenish the ice cubes and ensure maximum ice production.

### Using the ice off Function

When you select the Ice Off mode, remove all ice cubes from the bucket.

If you leave the ice cubes in the bucket, the ice cubes may clump together, making it difficult to remove them.

To remove the ice bucket safely and avoid injury, hold the bottom of the bucket with one hand and the side of the bucket with the other.

Then, lift up on the ice bucket, and pull it straight out.

To put the ice bucket back in, push it firmly straight back.

If the ice bucket is not pushed firmly into place, ice in the bucket can melt.

If the bucket does not fit, turn the helix 90 degree (see the last illustration on the right, below) and try again.

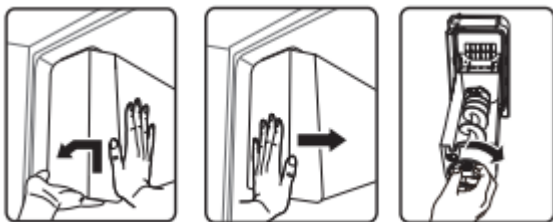

### CAUTION

- Use only the ice maker provided with the refrigerator.
- Have the refrigerator's water supply connected only to a potable water supply.
- To operate the ice maker properly, water pressure of 20 ~ 125 psi is required.

## Going on vacation...

If you are going on a long vacation or business trip and won't use the water or ice dispensers for a long time:

- Close the water valve. Otherwise, water leakage may occur.
- Remove all food and ice in the ice bucket.
- Unplug the refrigerator.
- Wipe excess moisture from inside and leave the doors open. Otherwise, odor and mold may develop.

## Ice Maker Do's and Don'ts

- Do not put your fingers, hands or any other unsuitable objects in the chute or ice-maker bucket.
- It may result in personal injury or material damage.
- Never put your finger or any other objects in the dispenser opening.
- It may cause injury.
- Do not try to disassemble the ice maker.
- Do not wash or spray the ice bucket with water while it is in the refrigerator.

Remove it to clean it.

**CAUTION:** When you insert the Ice maker tray, be sure that the tray is well centered at the entrance. Otherwise, the tray may get stuck.

## Water clouding phenomenon

All water provided to the refrigerator flows through the core filter which is an alkaline water filter.

In the filtering process, the pressure of the water that has flowed out of the filter is increased, and the water becomes saturated with oxygen and nitrogen. When this water flows out into the air, the pressure plummets and the oxygen and nitrogen get supersaturated, which results in gas bubbles.

The water may temporarily look misty or cloudy due to these oxygen bubbles. After a few seconds, the water will look clear.

Please wait 1 second before removing the cup after dispensing water to prevent spills.

Do not pull out the lever dispenser after dispensing ice or water.

It comes back automatically. Ice is made in cubes.

When you select “Crushed”, the ice maker grinds the ice cubes into crushed ice.

## PARTS AND FEATURES

Review the illustration below to become more familiar with the parts and features of your refrigerator.

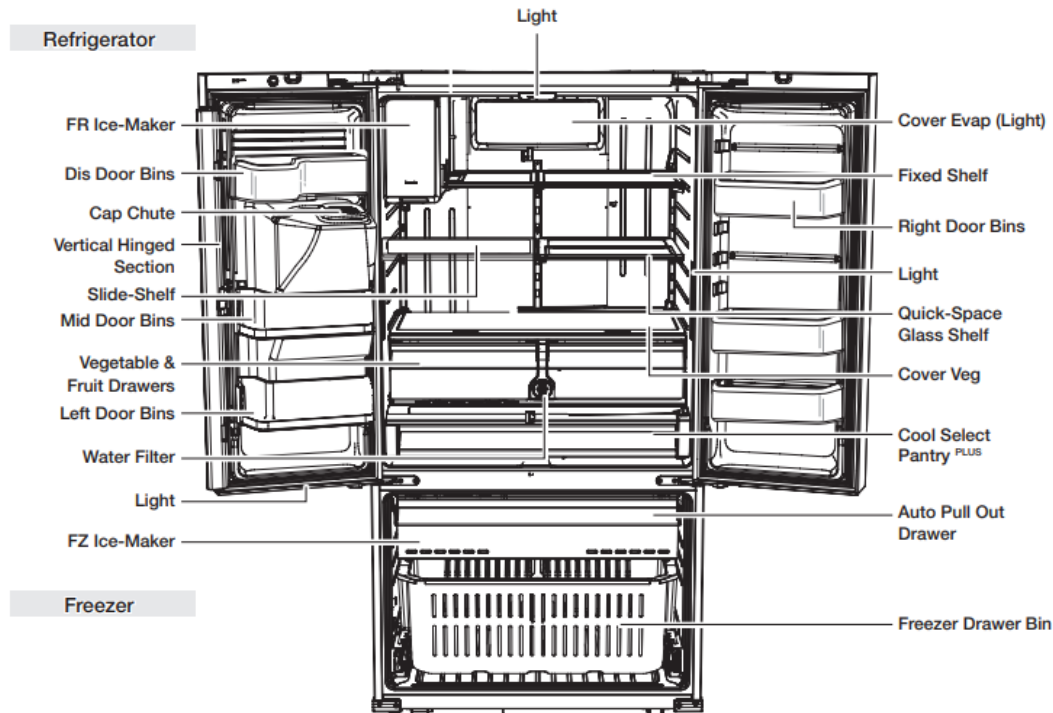

When closing the door, make sure the Vertical Hinged Section is in the correct position to avoid scratching the other door.

If the Vertical Hinged Section is reversed, put it back to the right position and close the door.

Moisture may appear at times on the Vertical Hinged Section.

The door handle may become loose over time.

If this happens, tighten the bolts found on the inside of the door.

If you close one door with too much force, the other door may open.

When the door opens, the interlock switch automatically turns off the auger motor in the ice maker for safety reasons.

When the interior or exterior LED lamp has gone out, please contact Samsung Customer Support.

## USING THE COOL SELECT PANTRY™

The Cool Select Pantry™ is a full-width drawer with adjustable temperature control.

This pantry can be used for large party trays, deli items, pizza, beverages, or miscellaneous items. There is a temperature control which can adjust the amount of cold air allowed into the pantry. The control is located on the right side of the pantry.

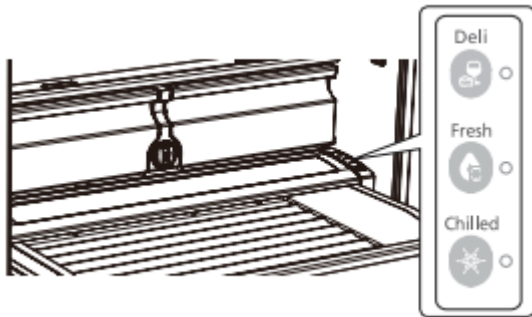

- The Pantry has three modes: The Fresh mode, Chilled mode, and Deli mode.

Fresh mode is the default.

Press the Temp button repeatedly until the mode you want is lit.

Once you select a mode, the temperature will change to match the mode you selected.

- The Pantry temperature may change depending on the number of items inside and where they are located, the ambient temperature, and how often the door is opened.

### The Pantry Selection Button

1. When you select “Deli”, the temperature of the pantry will be kept around 41 °F (or 5 °C). This feature helps keep food fresh for a long time.
2. When you select “Fresh”, the temperature of the pantry will be kept around 38 °F (or 3 °C). This feature helps keep food fresh for a longer time.
3. When you select “Chilled”, the temperature of the pantry will be kept around 34 °F (or 1 °C). This feature also helps keep meat or fish fresh for a longer time.

The table below lists the Pantry modes and the kinds of foods that can be stored safely for each mode.

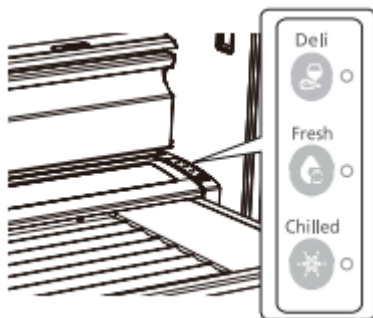

<b>Deli</b>	<b>Fresh</b>	<b>Chilled</b>
• Pineapple	• cucumbers	• steaks
• lemon	• apples	• hard cheeses
• avocado	• oranges	• cold cuts
• potato	• grapes	• bacon
	• zucchinis	• hot dogs
	• corn	

Fruits and vegetables may be damaged if you set the Pantry to the Chilled mode. Do not store lettuce or other leafy produce in this pantry.

### **CAUTION**

Do not store glass bottles in the Cool Select Pantry.

If they freeze, they can break and cause personal injury

### **REMOVING THE REFRIGERATOR ACCESSORIES**

#### **1. Door Bins**

- Door Bins ( 1 )

- **To remove** : Simply lift the bin up and pull straight out.

- **To relocate** : Slide it in above the desired location and push down until it stops.

- Door Bins ( 2 )

- **To remove** : PULL the door bin, frontally. take right side of the door bin out by lifting it at an angle along the guide, and then take the left side out by pulling it from the door.

- **To relocate** : slide it into the original location and push down until it sticks.

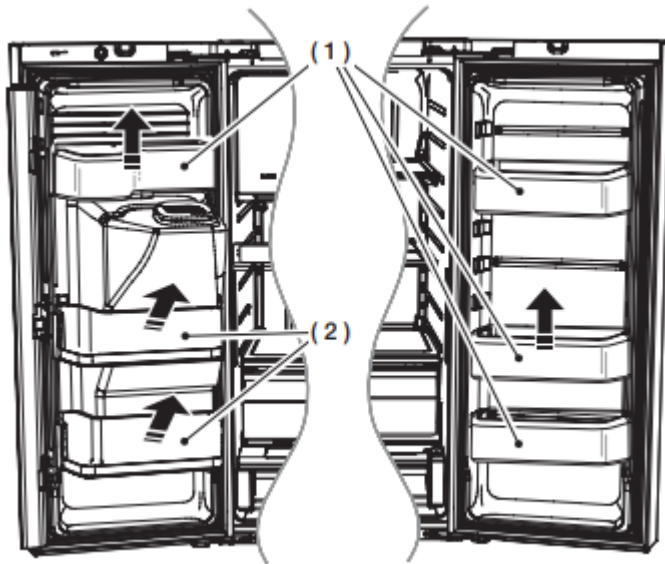

Injury may occur if the door bins are not firmly assembled.

Do not allow children to play with the bins. Sharp corners of the bins may cause injury.

### CAUTION

Do not adjust a bin full of food.

Remove the food first.

To remove dust from the bins : Remove the guard and wash the bin in water.

### 2. Tempered Glass shelves

- **To remove** : Hold the right shelf and remove the fixer from the left shelf.

Tilt up the front of the shelf in the direction shown ( 1 ) and lift it up vertically ( 2 ). Pull the shelf out.

- **To relocate** : Tilt the front of the shelf up and guide the shelf hooks into the slots at a desired height. Then lower the front of the shelf so that the hooks can drop into the slots.

Join the fixer between the left and right shelves.

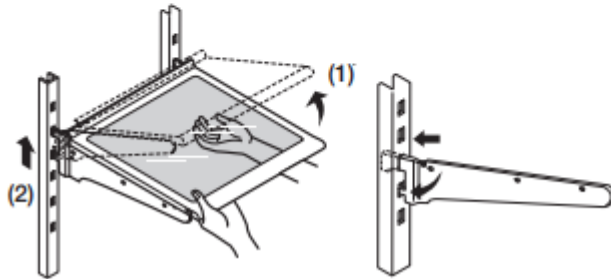
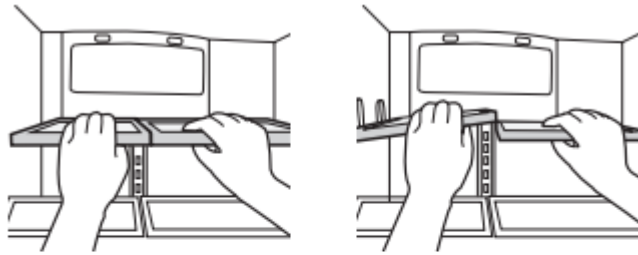

### CAUTION

The Tempered Glass shelves are heavy.

Use special care when removing them.

**CAUTION:** After sliding the foldable shelf in and folding it, the Shelf Front can be removed for your convenience. If you use the self without removing the Shelf Front, be aware the Shelf Front can separate from the shelf.

### 3. Vegetable & Fruit Drawers

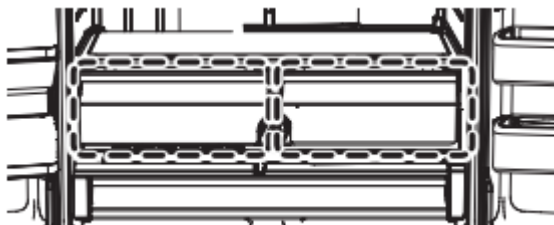

- Door Bins

Before removing the drawer, please remove door bins first as below.

#### To remove

- Simply lift the bin up and pull straight out.

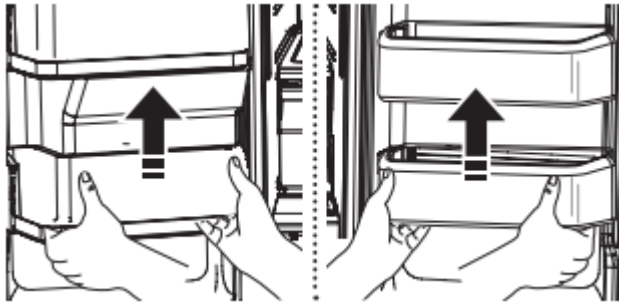

- Tilt up the front of the drawer and pull straight out, and pull out the drawer after moving slightly in the direction of the arrow.

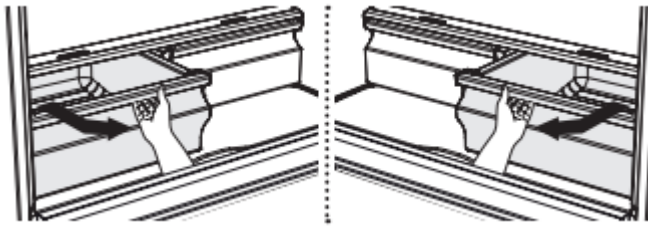

#### To re-install

- Insert the drawer into the frame rails and push back into place.
- Slide bin in above the desired location and push down until it stops.

**CAUTION:** The drawers need to be removed before the glass shelf above them can be lifted out.

#### 4. Cool Select Pantry PLUS

- **To remove the pantry :** Pull the pantry out to full extension. Tilt up the front side of the pantry and pull straight out.
- **To relocate the pantry :** Push the rails to the back of the refrigerator. Place the drawer onto the rails and slide the pantry back until it is in place.

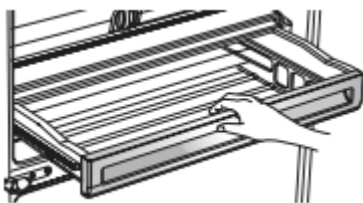

- **To remove the divider :** Pull the pantry completely out to full extension and raise the front side of the divider to unhook it from the rear wall of the pantry, then lift the divider out.
- **To relocate the divider :** Hook the back of the divider over the rear wall of the pantry and push the divider down.

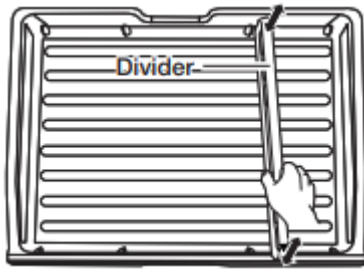

## Using the doors

Ensure that the doors close all the way and are securely sealed.

When the refrigerator door is only partially open, it will automatically close.

But, the door will stay open when opened more than the auto close range and you must close it manually.

## REMOVING THE FREEZER ACCESSORIES

### 1. Freezer Room Guard

- **To remove** : Remove the freezer room guard ( **1** ) by lifting the guard up.
- **To relocate** : Push down until the guard ( **1** ) locks into place.

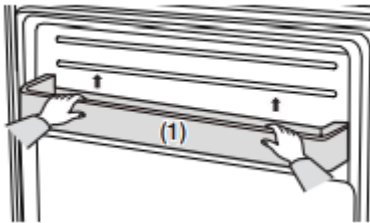

### 2. Ice Bucket

- **To remove** : Lift the ice bucket ( **1** ).
- **To relocate** : Place the ice bucket into the Super extended drawer ( **2** ).

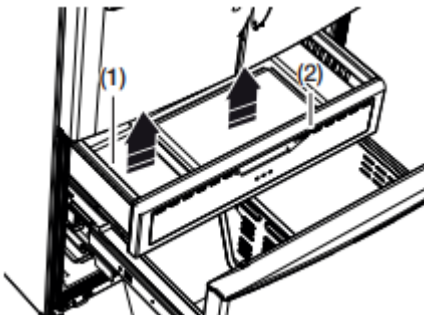

### 3. Super Extended Drawer

- **To remove** : Pull the drawer out to full extension. Tilt up the rear of the drawer and lift straight out.

- **To relocate** : Place the drawer onto the rails ( 4 ) by tilting it up.

Lower the drawer into place until it is horizontal and slide the drawer ( 3 ) in.

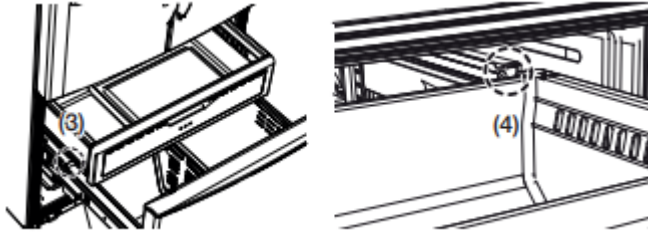

#### 4. Freezer Drawer

- **To remove the freezer drawer** : Pull the freezer drawer out fully. Tilt up the rear of the bin and lift it out to remove.

- **To relocate the freezer drawer** : Place the bin into the rail assembly

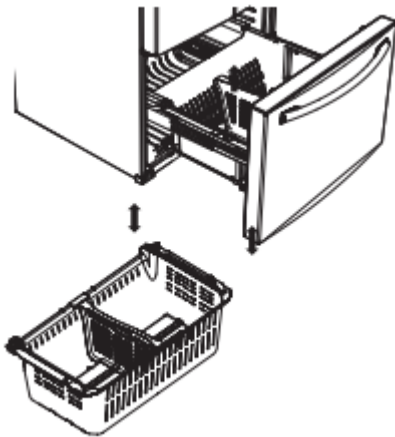

**CAUTION:** You can scratch the side of the bin if you twist it left or right when disassembling or re-assembling it.

#### **CAUTION**

Do not allow babies or children to climb into the freezer drawer.

They could damage the refrigerator and seriously injure themselves.

Do not sit on the freezer door.

The door may break.

**CAUTION:** Do not remove the divider.

**WARNING:** If trapped inside, children may be injured or suffocate to death.

## CLEANING THE REFRIGERATOR

Caring for your Samsung French Door Refrigerator prolongs the life of your appliance and helps keep the refrigerator free of odor and germs.

### Cleaning the Interior

Clean the inside walls and accessories with a mild detergent and then wipe dry with a soft cloth. You can remove the drawers and shelves for a more thorough cleaning.

Just make sure to dry drawers and shelves before putting them back into place.

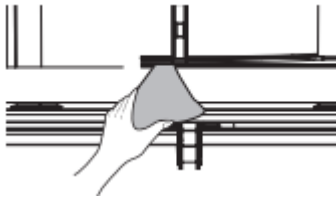

### Cleaning the Exterior

Wipe the control panel and digital display with a damp, clean, soft cloth.

Do not spray water directly on the surface of the refrigerator.

The doors, handles, and cabinet surfaces should be cleaned with a mild detergent and then wiped dry with a soft cloth.

To keep your appliance looking its best, polish the exterior once or twice a year.



**CAUTION:** Do not spray water directly on the refrigerator. Use a clean, damp cloth to clean.

### CAUTION

Do not use benzene, thinner, or Clorox for cleaning.

They may damage the surface of the appliance and may cause a fire.

**CAUTION:** You can erase the printed letters on the display if you apply stainless cleaner directly to the area where the letters are printed.



## Cleaning the Ice / Water Dispenser

Push down one end of the tray dispenser and remove it.

Wipe the Ice / Water Dispenser with a clean and soft cloth.

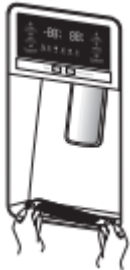

### CAUTION

As you use the dispenser's crushed ice selection, some residual ice chips may start to collect in the ice chute.

To prevent that residual ice from melting and running out of the chute, you should clean out the residual ice when you see it start to collect in the ice chute.

## Cleaning the Rubber door seals

If the rubber door seals are dirty, the doors may not close properly, and the refrigerator will not operate efficiently. Keep the door seals free of dust or stains by cleaning the doors with a mild detergent and damp cloth.

Wipe dry with a clean, soft cloth.

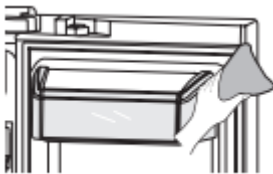

### CAUTION

Do not clean the refrigerator with benzene, thinner, or car detergent.

These substances could cause a fire.

## Cleaning the rear side of the refrigerator

To keep cords and exposed parts free of dust and dirt accumulation, vacuum the rear side of the appliance once or twice a year.

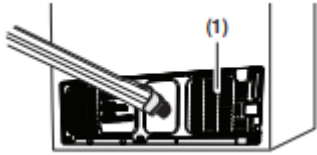

**CAUTION**

Do not remove the back cover ( **1** ).

You could suffer an electric shock.

## FOOD STORAGE TIPS

Foods	Refrigerator	Freezer	Storage Tips
<b>DAIRY PRODUCTS</b>			
Butter	2-3 Weeks	6-9 Months	Wrap or cover tightly.
Milk	1-2 Weeks	Not recommended	Check date code. Most milk and similar products are sold in date-coded cartons that indicate a product's peak freshness. Re-seal with cap or wrap tightly. Do not return unused portions to original container.
Cream Cheese, cheese food, and cheese spread	2-4 Weeks	Not recommended	Check date code. Keep all cheese tightly packed in moisture proof wrap
Hard Cheese (unopened)	3-4 Months	6 Months	
Hard Cheese (opened)	2 Months	Not recommended	
Cottage Cheese	10-15 Days	Not recommended	
Cream	7-10 Days	2 Months	Check date code. Most yogurt, creams, and similar products are sold in date-coded cartons that indicate a product's peak freshness. Re-seal or cover tightly. Do not return unused portions to original container.
Sour Cream	2 Weeks	Not recommended	
Cream Dips (opened)	1 Week	Not recommended	Check date code. Keep covered.
Yogurt	10-14 Days	Not recommended	
Frozen Yogurt	na	2 Months	
<b>EGGS</b>			
Eggs (uncooked)	3-4 Weeks	Not recommended	Check date code. Store eggs in coldest part of refrigerator and in their original container.
Eggs (cooked)	1 Week	Not recommended	Store in covered container
Leftover egg dishes	3-4 Days	Not recommended	Store in covered container
<b>FRESH FRUITS</b>			
Apples	1 Month	Not recommended	If storing in refrigerator, do not wash fruit before storing. Store in moisture resistant bags or containers. Wrap cut fruits. Some fruits darken when refrigerated.
Bananas	2-4 Days	Not recommended	
Peaches, Melons, Pears, Avocados	3-5 Days	Not recommended	
Berries and Cherries	2-3 Days	12 Months	
Apricots	3-5 Days	Not recommended	
Grapes	2-5 Days	na	
Pineapple (un-cut)	2-3 Days	Not recommended	
Pineapple (cut)	5-7 Days	6-12 Months	
Citrus	1-2 Weeks	Not recommended	Store uncovered.
Juice	6 Days	Not recommended	Check date code and re-seal in original container. Do not return unused portions to original container.
Frozen Juice	Thawing only	12 Months	Check date code. Do not re-freeze.
<b>FISH AND SHELLFISH</b>			
<b>Fish</b>			
Fatty Fish (mackerel, trout, salmon)	1-2 Days	2-3 Months	Keep in original wrapper and store in coldest part of refrigerator. Package in vapor-proof and moisture proof wrap for freezer. Freeze at 0 °F (or -18 °C). Thaw in refrigerator or check date code. Freeze in original packaging.
Lean Fish (cod, flounder, etc)	1-2 Days	6 Months	
Frozen or Breaded	na	3 Months	

Foods	Refrigerator	Freezer	Storage Tips
<b>Shellfish</b>			
Shrimp (uncooked)	1-2 Days	12 Months	To freeze, package in vapor-proof and moisture-proof container.
Crab	3-5 Days	10 Months	
Cooked Fish or Shellfish	2-3 Days	3 Months	
<b>MEAT</b>			
<b>Fresh, Uncooked</b>			
Chops	2-4 Days	6-12 Months	Check date code for use. Store in coldest part of refrigerator in original packaging. Package in moisture-proof and vapor-proof container for freezing. Recommended refrigerator temperature 33 °F to 36 °F (or 1 °C to 2 °C ) and freezer temperature 0 °F to 2 °F (or -18 °C to -16 °C )
Ground	1 Day	3-4 Months	
Roast	2-4 Days	6-12 Months	
Bacon	1-2 Weeks	1-2 Months	
Sausage	1-2 Days	1-2 Months	
Steak	2-4 Days	6-9 Months	
Poultry	1 Day	12 Months	
Lunch meat	3-5 Days	1 Month	
<b>Cooked</b>			
Meat	2-3 Days	2-3 Months	Check date code for use. Store in coldest part of refrigerator in original packaging. Package in moisture-proof and vapor-proof container for freezing.
Poultry	2-3 Days	4-5 Months	
Ham	1-2 weeks	1-2 Months	

**Sources:**

American Meat Institute Foundation. 1994. Yellow pages: answers to predictable questions consumers ask about meat and poultry. American Meat Institute Food Marketing Institute. 1999. The food keeper. Food Marketing Institute, Washington, D.C. Freeland-Graves, J.H. and G.C. Peckham. 1996. Foundations of food preparation, 6th ed. Prentice-Hall, Inc. Englewood Cliffs, NJ. Hillers, V.N. 1993. Storing foods at home. Washington State University Cooperative Extension, Pullman, WA. Publ. EB 1205. National Restaurant Association. 2001. Be cool-chill out! Refrigerate promptly. National Restaurant Association Education Foundation¼s International Food Safety Council, Washington, D.C. USDA. 1997. Basics for handling food safely. U.S. Department of Agriculture, Food Safety and Inspection Service, Washington, D.C.



## Troubleshooting

PROBLEM	SOLUTION
<p><b>The refrigerator does not work at all or it does not chill sufficiently.</b></p>	<ul style="list-style-type: none"> <li>• Check if the power plug is properly connected.</li> <li>• Check if the set temperature on the digital display is warmer than the freezer or fridge inner temperature. If it is, set the freezer or fridge to a colder temperature.</li> <li>• Is the refrigerator in direct sunlight or located near a heat source?</li> </ul> <p>If so, it may not be able to cool sufficiently. Install it in a location that is out of direct sunlight and not near a heat source.</p> <ul style="list-style-type: none"> <li>• Is the back of the refrigerator too close to the wall, preventing proper ventilation?</li> </ul> <p>If so, it may not be able to cool sufficiently.</p> <p>Keep it an appropriate distance from the wall.</p> <ul style="list-style-type: none"> <li>• Is there too much food inside so that the food is blocking the outlet vent?</li> </ul> <p>To keep the refrigerator at a suitable temperature, do not fill the refrigerator with too much food.</p>
<p><b>The food in the fridge is frozen.</b></p>	<ul style="list-style-type: none"> <li>• Check if the set temperature on the digital display is too low.</li> </ul> <p>If so, raise the set temperature inside the refrigerator.</p> <ul style="list-style-type: none"> <li>• Is the temperature in the room too low? Set the refrigerator warmer.</li> <li>• Did you store food with a high moisture content in the coldest part of the refrigerator or near the cooling outlet vent?</li> </ul> <p>Try moving those items to the other shelves in the fridge instead of keeping them in the colder areas or bins.</p>
<p><b>You hear unusual noise or sounds.</b></p>	<ul style="list-style-type: none"> <li>• Check if the refrigerator is level and stable.</li> </ul>



	<ul style="list-style-type: none"> <li>• Is the back of the refrigerator too close to the wall, preventing proper ventilation?</li> <li>• Was anything dropped behind or under the refrigerator?</li> <li>• If you hear a “ticking” sound from inside the refrigerator, this is normal.</li> </ul> <p>It occurs because various parts contract or expand in response to temperature changes in the refrigerator interior.</p> <ul style="list-style-type: none"> <li>• If it sounds as if something is hitting something else inside the refrigerator, this is normal. The sound is caused by the compressor operating at high capacity</li> </ul>
<p><b>The cabinet-door sealing area of the appliance is hot and condensation is occurring.</b></p>	<ul style="list-style-type: none"> <li>• Some heat is normal as anti-condensators are installed in the vertical hinged section of the refrigerator to prevent condensation.</li> <li>• Is the refrigerator door ajar?</li> </ul> <p>Condensation can occur when you leave the door open for a long time.</p>
<p><b>The ice Maker is not producing ice.</b></p>	<ul style="list-style-type: none"> <li>• It may take longer to make ice if it is not sufficiently cool, such as when first installed.</li> <li>• Is the water line connected and the shut-off valve opened?</li> <li>• Did you manually stop the ice making function?</li> <li>• Check if the filter is properly installed. If it is not properly installed, the ice making function may not work.</li> </ul>
<p><b>You can hear water bubbling in the refrigerator.</b></p>	<ul style="list-style-type: none"> <li>• This is normal.</li> </ul> <p>The bubbling comes from refrigerant circulating through the refrigerator.</p>
<p><b>There is a bad smell in the refrigerator.</b></p>	<ul style="list-style-type: none"> <li>• Check for spoiled food.</li> </ul>



	<ul style="list-style-type: none"> <li>• Foods with strong odors (for example, fish) should be tightly covered.</li> <li>• Clean out the freezer periodically and throw away any spoiled food.</li> </ul> <p>When cleaning the inside of the fridge, store food elsewhere and unplug the appliance. Wipe with a dry dishcloth after 2-3 hours and then circulate air inside the refrigerator.</p>
<p><b>Frost forms on the walls of the freezer.</b></p>	<ul style="list-style-type: none"> <li>• Is the air vent blocked?</li> </ul> <p>Remove any obstructions so air can circulate freely.</p> <ul style="list-style-type: none"> <li>• Allow sufficient space between the stored foods for efficient air circulation.</li> <li>• Is the freezer drawer closed properly?</li> </ul> <p>If the freezer drawer is not completely closed or is blocked, humidity from outside may enter and cause severe frost to form</p>
<p><b>The water dispenser is not functioning.</b></p>	<ul style="list-style-type: none"> <li>• Is the water line connected and the shut-off valve opened?</li> <li>• Has the water supply line tubing been crushed or kinked?</li> <li>• Make sure the tubing is free and clear of any obstruction.</li> <li>• Is the water tank frozen because the fridge temperature is too low?</li> </ul> <p>Try selecting a warmer setting on the Digital display.</p> <ul style="list-style-type: none"> <li>• Is the Child Lock on?</li> <li>• Check if the filter is properly installed.</li> </ul> <p>If it is not properly installed, the water dispenser may not work</p>
<p><b>The auto close system does not work with the freezer door.</b></p>	<ul style="list-style-type: none"> <li>• Is there an imbalance between the right and left parts of the door?</li> <li>• Open and close the door smoothly 1~2 times.</li> </ul>



	<p>After you do this, the auto close system usually works properly again.</p> <ul style="list-style-type: none"> <li>• Try opening the door smoothly to avoid unbalancing the right and the left part of the door.</li> </ul>
<p><b>Condensation or water drops forms on vertical mullion and surroundings, etc</b></p>	<ul style="list-style-type: none"> <li>• Condensation or water drops may form if the humidity is too high while the refrigerator is operating.</li> <li>• If condensation or water drops appears on vertical mullion and surroundings, etc., turn the Energy Saver mode off after removing the condensation.</li> </ul> <p>(See the explanation of the Energy Saver button in “Using the Control Panel” on page 21.)</p>
<p><b>What Do I Need to Use the E-Smart and Smart Grid functions?</b></p>	<ul style="list-style-type: none"> <li>• To use the Smart Grid (Demand Response) and E-Smart function on your Refrigerator, you need the following devices and apps: <ul style="list-style-type: none"> <li>- Devices: 1) Wireless Router, 2) Samsung E-Smart Refrigerator, 3) Smartphone (Recommended: Galaxy S4, Galaxy Note3 or later models and Android OS Jelly Bean or later version)</li> <li>- Applications: 1) “Samsung E-Smart App” from the Google Play Store or Samsung Apps.</li> </ul> </li> </ul> <p>You also need to:</p> <ul style="list-style-type: none"> <li>• Connect the Refrigerator and the Smartphone to the same Wi-Fi network in your home.</li> <li>• Install and run Samsung E-Smart App on your Smartphone (to use the Samsung E-Smart function).</li> <li>• In addition, to use the Smart Grid (Demand Response) function, you must Register for the service with your electric company.</li> </ul> <p>The company must have an EMS (Energy Management System) that supports SEP (Smart Energy profile).</p>



<p><b>Why isn't the E-Smart function working normally?</b></p>	<ul style="list-style-type: none"> <li>• Confirm that the router in your home and the Internet are working properly.</li> <li>- Connect a Smartphone to the router (AP, Access Point), and then confirm that you can browse the Internet on the phone.</li> <li>• Confirm that refrigerator is connected to the AP.</li> <li>- Check the E-Smart icon on the PANEL of refrigerator.</li> </ul> <p>If the refrigerator is connected, the icon will be on.</p> <ul style="list-style-type: none"> <li>• Confirm that the refrigerator and Smart Phone are connected to the same router.</li> </ul>
<p><b>Why isn't the Delay Defrost Capability working normally?</b></p>	<ul style="list-style-type: none"> <li>• Confirm that the router in your home and the Internet are working properly.</li> <li>- Connect a Smartphone to the router (AP, Access Point), and then confirm that you can browse the Internet on the phone.</li> <li>• Confirm that the area where you live is properly entered into the Smart phone App.</li> <li>• Confirm that the Smart Grid function works correctly.</li> </ul> <p>(Check the PANEL. L3 and L4 should not be displayed on the PANEL.)</p>

## OPEN SOURCE ANNOUNCEMENT

The software included in this product contains open source software.

You may obtain the complete corresponding source code for a period of three years after the last shipment of this product by sending an email to <mailto:oss.request@samsung.com>.

It is also possible to obtain the complete corresponding source code in a physical medium such as a CDROM; a minimal charge will be required.

The following URL <http://opensource.samsung.com/opensource/ConnectedProduct/seq/0> leads to the download page of the source code made available and open source license information as related to this product.

This offer is valid to anyone in receipt of this information.

**Warning**

This content is compiled from multiple sources and is provided for reference purposes only. It may not be complete or fully applicable to all situations. If you are unable to resolve your issue, please contact the product manufacturer or an authorized service provider for official support.

---

Document generated by [ManualsFile](#)