

## USING THE WASHER

### Getting started

#### **▲ WARNING**

To reduce the risk of fire, electric shock, or injury to persons, read the IMPORTANT SAFETY INFORMATION before operating this appliance.

Throughout this manual, features and appearance may vary from your model.



#### Step 1 (Appearance will vary)

- Add fabric softener to the fabric softener dispenser; see page 10.
- Add the manufacturer's recommended amount of detergent. GE Appliances recommends the use of High Efficiency detergents such as  in your energy efficient washer. Place detergent pods in the bottom of the wash basket before adding clothes.



#### Step 2

- Loosely add items. Overloading may negatively impact wash performance. See page 11 for suggested loading examples.
- Close door.

**NOTE:** Washer will not start with door open.

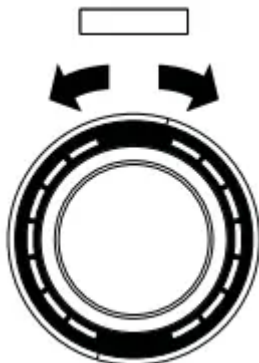

#### Step 3

- If the screen is dark, press the Power button to “wake up” the display.
- Select a wash cycle. (Defaults are set for each wash cycle. These default settings can be changed. See Control settings for more information.)

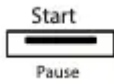

**Step 4**

- Press the Start/Pause button.

**Display and Status Lights**

The display shows cycle status (FILL ► WASH ► RINSE ► SPIN), the Estimated Time Remaining until the end of the cycle and the options selected. In addition, the display will show:



Controls locked on



End of cycle signal on.



Indicates Delay Wash set time is selected.

**NOTE:** If an out-of-balance condition is detected by the washer, the SPIN light will blink during the remaining portion of the cycle and will stay illuminated for a short time after cycle completion. When this occurs, the washer is taking actions to correct the out-of-balance condition and complete the cycle normally. In some cases, the washer may not be able to balance the load and spin up to full speed. If you notice the load is more wet than usual at the end of the cycle, redistribute the load evenly in the wash tub and run a drain and spin cycle. Select Rinse+Spin cycle and select no rinse by pressing Rinse until both Extra and Normal lights turn off.

**Controls**

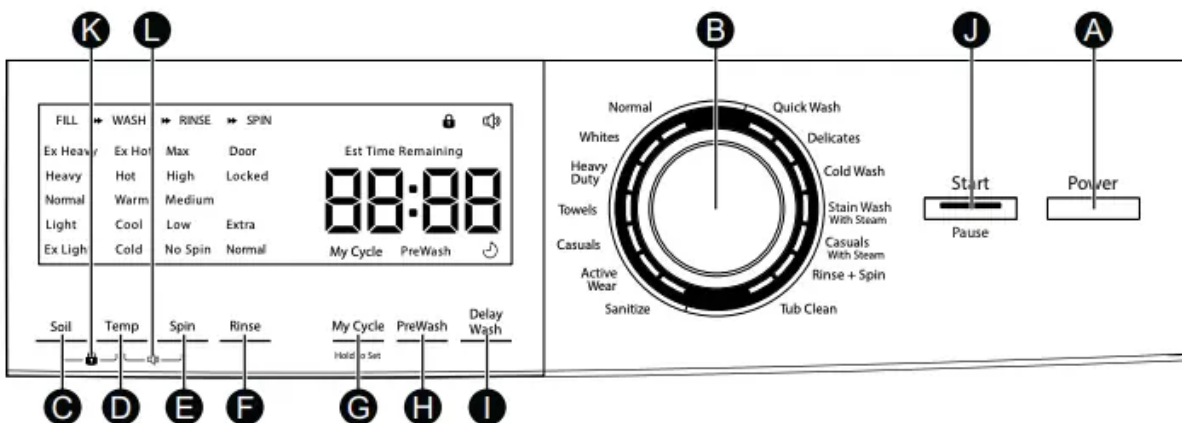

**Power**

Press to “wake up” the display. If the display is active, press to put the washer into standby mode.

**NOTE:** Pressing Power does not disconnect the appliance from the power supply



## **B** Wash Cycles

The wash cycles are optimized for specific types of wash loads. The chart below will help you match the wash setting with the loads. The Gentle Wash™ lifters lightly tumble the clothes into the water and detergent solution to clean the load.

Items to Wash	Cycle	Soil Level	Wash Temp	Spin Selection	Options Available	Cycle Details
Cycle for normal, regular, or typical use for washing up to a full load of normally soiled cotton clothing.	Normal	Ex. Heavy Heavy <b>Normal</b> Light Ex. Light	Extra Hot Hot <b>Warm</b> Cool Cold	<b>Max</b> <b>High</b> Medium No Spin	Prewash Extra Rinse Delay Wash My Cycle	Cycle for normal, regular, or typical use for washing up to a full load of normally soiled cotton clothing. Choose the Heavy or Extra Heavy soil level selection and Warm or Hot water temperature selection as appropriate for your clothes load for a higher degree of cleaning.
Whites and household linens.	Whites	Ex. Heavy Heavy <b>Normal</b> Light Ex. Light	Extra Hot Hot <b>Warm</b> Cool Cold	<b>Max</b> High Medium Low No Spin	Prewash Extra Rinse Delay Wash My Cycle	Cycle tailored to clean and brighten your whites.
Towels, sheets, pillowcases and dish rags.	Towels	Ex. Heavy Heavy <b>Normal</b> Light Ex. Light	Extra Hot Hot <b>Warm</b> Cool Cold	<b>Max</b> High Medium Low No Spin	Prewash Extra Rinse Delay Wash My Cycle	Cycle designed for washing towels, sheets, pillowcases and dish rags. It is recommended that towels and sheets be washed separately for best care and washing performance.
Sturdy fabrics with heavy to medium soil.	Heavy Duty	Ex. Heavy <b>Heavy</b> Normal Light Ex. Light	Extra Hot Hot <b>Warm</b> Cool Cold	<b>Max</b> High Medium Low No Spin	Prewash Extra Rinse Delay Wash My Cycle	Incorporates multi-step wash and soak periods combined with extended wash periods to effectively clean heavily to medium soiled sturdy fabrics.
Casual clothes, lightly soiled office wear.	Casuals	Ex. Heavy Heavy <b>Normal</b> Light Ex. Light	Extra Hot Hot Warm <b>Cool</b> Cold	Max <b>High</b> Medium Low No Spin	Prewash Extra Rinse Delay Wash My Cycle	Wash cycle tailored to care for casual clothes and office wear items.
Medium to lightly soiled athletic wear items of technical or synthetic fabrics.	Active Wear	Ex. Heavy <b>Heavy</b> Normal Light Ex. Light	Extra Hot Hot Warm <b>Cool</b> Cold	Max <b>High</b> Medium Low No Spin	Prewash Extra Rinse Delay Wash My Cycle	Cycle designed for care of medium to lightly soiled active wear, athletic wear and technical fabrics.
Heavily soiled colorfast items with the need for sanitization.	Sanitize	Ex. Heavy Heavy <b>Normal</b>	<b>Extra Hot</b>	<b>Max</b> High Medium Low No Spin	Prewash Extra Rinse Delay Wash My Cycle	Use this cycle to eliminate 99.9% of bacteria from fabrics. Cycle uses an increased water temperature and a longer wash cycle to provide the sanitization benefit. A longer rinse is incorporated to remove contaminants. For best results, select the Extra Heavy soil selection if available. See <b>NOTE</b> below.
Lingerie and special care fabrics with light soil.	Delicates	Ex. Heavy Heavy <b>Normal</b> Light Ex. Light	Warm Cool <b>Cold</b>	High <b>Medium</b> Low No Spin	Prewash Extra Rinse Delay Wash My Cycle	For lightly soiled items labeled hand-washable. Provides gentle tumbling and soak during wash and rinse.

Items to Wash	Cycle	Soil Level	Wash Temp	Spin Selection	Options Available	Cycle Details
Small loads of lightly soiled items that are needed in a hurry.	Quick Wash	Ex. Heavy Heavy Normal Light <b>Ex. Light</b>	Hot <b>Warm</b> Cool Cold	<b>Max</b> High Medium Low No Spin	Prewash Extra Rinse Delay Wash My Cycle	For cleaning lightly soiled loads in the fastest time possible. Cycle time is approximately 33 minutes, depending on selected options.
Cycle for washing a full load of normally soiled cotton clothing in cold water.	Cold Wash	Ex. Heavy Heavy <b>Normal</b> Light Ex. Light	Cool <b>Cold</b>	<b>Max</b> High Medium Low No Spin	Prewash Extra Rinse Delay Wash My Cycle	Cycle for washing a full load of normally soiled cotton clothing in cold water. This cycle uses cold water only and extends the wash time to get clothes clean.
Cycle for heavily soiled colorfast laundry	Stain Wash with Steam	Ex. Heavy Heavy <b>Normal</b> Light Ex. Light	Extra Hot Hot <b>Warm</b> Cool Cold	<b>Max</b> High Medium Low No Spin	Prewash Extra Rinse Delay Wash My Cycle	Add steam to the washer to assist with stain removal for heavily soiled colorfast laundry.
Cycle for heavily soiled casuals laundry	Casuals with Steam	Ex. Heavy Heavy <b>Normal</b> Light Ex. Light	Extra Hot Hot <b>Warm</b> Cool Cold	<b>Max</b> High Medium Low No Spin	Prewash Extra Rinse Delay Wash My Cycle	Add steam to the washer to assist with stain removal for heavily soiled casual clothes and office wear items.
For items that need only to be rinsed, use this cycle.	Rinse + Spin			<b>Max</b> High Medium Low No Spin	Prewash Extra Rinse Delay Wash My Cycle	To quickly rinse and spin out any items at any time. Utilizes a high speed spin to extract water from wet items. To achieve a drain and spin, deselect the Extra Rinse option. This cycle will dispense prewash detergent and fabric softener.
Cleaning the tub of residue and odor. No clothes to be washed using this cycle.	Tub Clean					<b>Recommended use of at least once per month</b> to clean the basket of residue and odor. Never load laundry when using this cycle; laundry may become damaged. Cycle incorporates a hot extended wash, intense agitation action and a flush out of the pump.

**NOTE:** The Sanitize cycle water temperatures CANNOT be changed. The Sanitize cycle is certified by NSF International, an independent third party testing and certification organization.

The Sanitize certification verifies that the cycle reduced 99.9% of bacteria typically found in residential laundry and that no significant contamination is transferred to subsequent washer loads. Only the Sanitize cycle has been designed to meet the requirements of NSF Protocol P172 for sanitizing effectiveness.

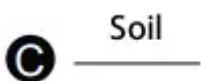

Soil

## Soil

Changing the Soil level increases or decreases the wash time to remove different amounts of soil. To change the Soil level, press the Soil level button until you have reached the desired setting. You can choose between Extra Light, Light, Normal, Heavy or Extra Heavy soil.

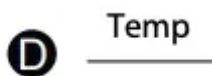

Temp

## Temp

Adjust to select the proper water temperature for the wash cycle. The rinse water is always cold to help reduce energy usage and reduce setting of stains and wrinkles. Follow the fabric manufacturer's care label when selecting the wash temperature. To change the wash temperature, press the Temp button until you have reached the desired setting. You can choose between Cold, Cool, Warm, Hot or Extra Hot.

## Spin

### Spin

Changing the Spin setting changes the final spin speed of the cycles. Always follow the garment manufacturer's care label when changing the Spin setting.

To change the Spin setting, press the Spin setting button until you have reached the desired setting. You can choose between No Spin, Low, Medium, High or Max. Higher spin speeds are not available on certain cycles, such as Delicates.

Higher spin speeds remove more water from the clothes and will help reduce dry time, but may also increase the possibility of setting wrinkles on some fabrics.

## Rinse

### Rinse

Changing Rinse will change the number of rinses the cycle will use. To change the rinse option, press Rinse until you have reached the desired setting. You can choose between Normal, Extra and no rinse. In order to select no rinse, press the Rinse button until no lights are lit in the rinse window.

On Rinse+Spin cycle, a drain and spin cycle can be achieved by selecting no rinse.

## My Cycle

### Hold to Set

### My Cycle

To save a favorite cycle, set the desired settings for wash cycle, soil level, spin speed and wash temp settings and hold down the My Cycle button for 3 seconds. A beep will sound to indicate the cycle has been saved.

To use your custom cycle, press the My Cycle button before washing a load.

To change the saved cycle, set the desired settings and hold down the My Cycle button for 3 seconds.

**NOTE:** When using My Cycle, wash options cannot be modified after the cycle has been started.

**NOTE:** If you change wash options with My Cycle before starting the cycle, the My Cycle light will turn off and you will be returned to the base cycle.

## **H** PreWash

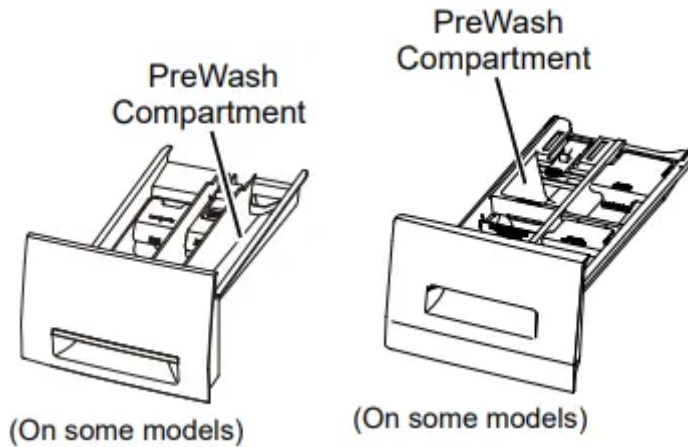

### **PreWash**

Prewash is an extra wash before the main wash. Use it for heavily soiled clothes or for clothes with a care label that recommends prewashing before washing. Be sure to add liquid or powder high-efficiency detergent, or the proper wash additive to the prewash dispenser.

The PreWash feature will fill the washer with water (adding the prewash detergent), tumble the clothes, drain and spin. Then the washer will run the selected wash cycle.

**NOTE:** The PreWash is not selected automatically and must be selected before starting the cycle.

## **I** Delay Wash

### **Delay Wash**

Use to delay the start of your washer.

1. Choose your wash cycle and any options.
2. Press Delay Wash button. You can change the delay time in 1-hour increments (up to 24 hours) each time you press the Delay Wash button. Stop pressing the button when your desired time is displayed.
3. Press the Start/Pause button to start the countdown. The countdown time will be shown in the Est Time Remaining (Estimated Time Remaining) display.

**NOTES:**

- If the door is opened while the washer is in Delay Wash, the countdown time will stop the count down and the display will say “door”. The door must be closed and the Start/Pause button must be pressed to continue the delay time count down.
- You can delay the start of a washer cycle up to 24 hours. The light on the button will light up when Delay Wash is on.

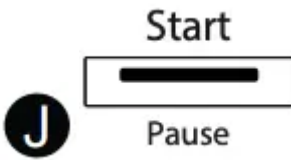

### Start/Pause

Press to start a wash cycle. If the washer is running, pressing it once will pause the washer and unlock the door. This function can be used to add garments during a cycle. Press again to restart the wash cycle.

**NOTE:** If the washer is paused and the cycle is not restarted within 15 minutes, the current wash cycle will be cancelled.

**NOTE:** In some cases the washer will drain first, then unlock the door when it is paused.

**NOTE:** The washer performs automatic system checks after pressing the Start/Pause button. Water will flow in 45 seconds or less. You may hear the door lock and unlock before water flows; this is normal.

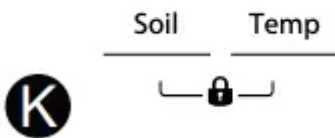

### Lock

You can lock the controls to prevent any selections from being made. Or you can lock or unlock the controls after you have started a cycle.

Children cannot accidentally start the washer by touching pads with this option selected.

To lock the washer, press and hold the Soil and Temp buttons together for 3 seconds.

To unlock the washer controls, press and hold the Soil and Temp buttons together for 3 seconds. A sound is made to indicate the lock/unlock status.

The control lock icon on the display will light up when it is on.

**NOTE:** The Power button can still be used when the machine is locked.

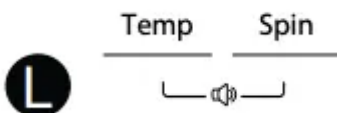

## Signal

When the light is on, the washer will beep at the end of the cycle and every time you press a button on the control panel. To turn the signal off, press and hold the Temp and Spin buttons together for 3 seconds. A sound is made to indicate the lock/unlock status.

## Dispenser Drawer

Slowly open the dispenser drawer by pulling it out until it stops.

After adding laundry products, slowly close the dispenser drawer. Closing the drawer too quickly could result in early dispensing of the fabric softener or detergent.

You may see water in the fabric softener compartment at the end of the cycle. This is a result of the flushing/siphoning action and is part of the normal operation of the washer.

Use only HE  
High-Efficiency  
detergent

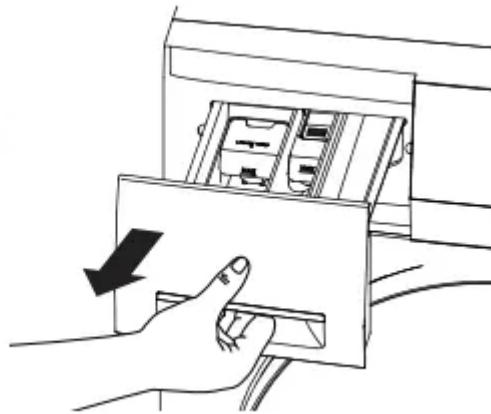

## Detergent Compartment

- Only use high-efficiency detergent in this washer. Use the detergent manufacturer's recommended amount. DO NOT fill above the MAX line.
- Detergent is flushed from the dispenser at the beginning of the wash cycle. Either powdered or liquid high-efficiency detergent can be used.
- Detergent usage may need to be adjusted for water temperature, water hardness, size and soil level of the load. Avoid using too much detergent in your washer since it can lead to oversudsing and detergent residue being left on the clothes

## Cup and Cavity Drawer System (on some models)

The detergent compartment is in the left side of the dispenser drawer. The detergent cavity (cup removed) is used for powder detergent, and the detergent cup is used for liquid detergent.

- Powder Detergent – Remove the detergent cup and pour the suggested amount of powder detergent into the detergent cavity.
- Liquid Detergent – Leave the detergent cup in the drawer and pour liquid detergent into the cup. Do not fill above the MAX line.

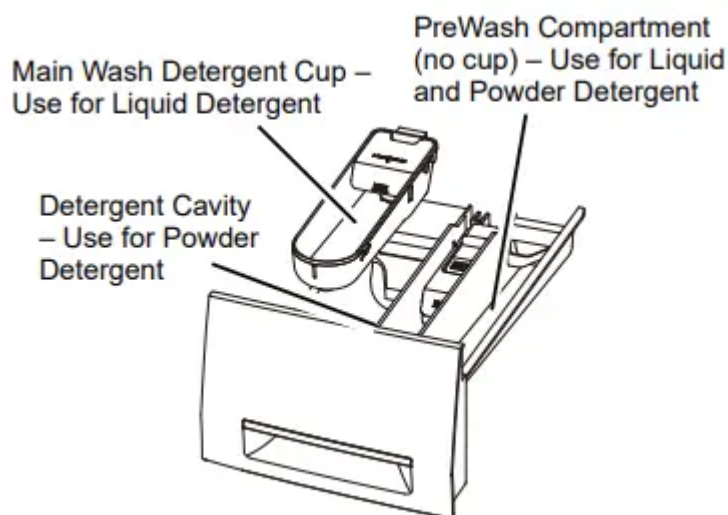

### Divider Drawer System (on some models)

The detergent compartment is in the front left of the dispenser drawer.

- Powder Detergent – Lock the detergent card flat into its top position in the compartment. Make sure the card is locked, then pour the suggested amount of powder detergent into the detergent dispenser.
- Liquid Detergent – Lock the detergent card vertically into its center position in the compartment. Make sure the card is locked, then pour the suggested amount of liquid detergent into the detergent dispenser.

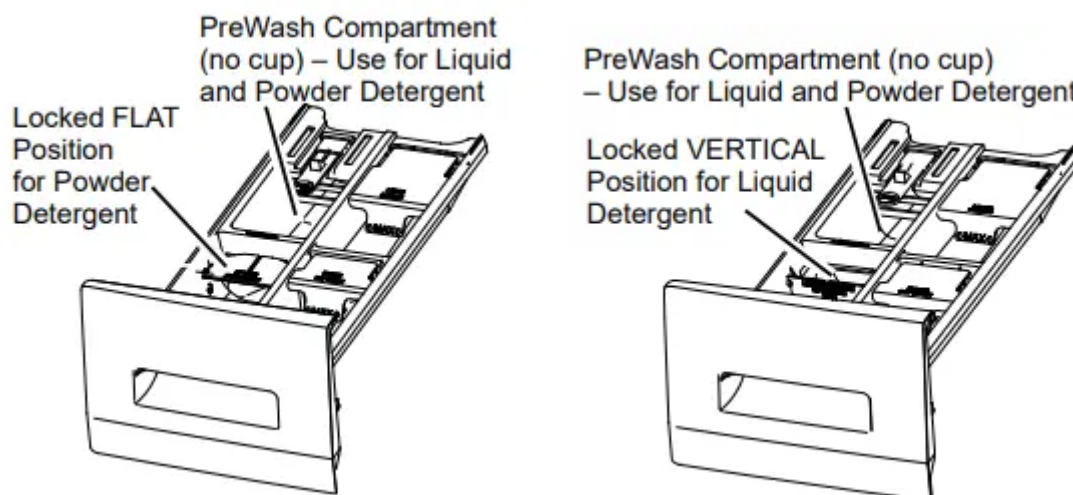

### Fabric Softener Compartment

If desired, pour the recommended amount of liquid fabric softener into the compartment labeled “Fabric Softener.”

Use only liquid fabric softener in the dispenser.

Dilute with water to the maximum fill line.

Do not exceed the maximum fill line. Overfilling can cause early dispensing of the fabric softener, which could stain clothes.

**NOTE:** Do not pour fabric softener directly on the wash load.

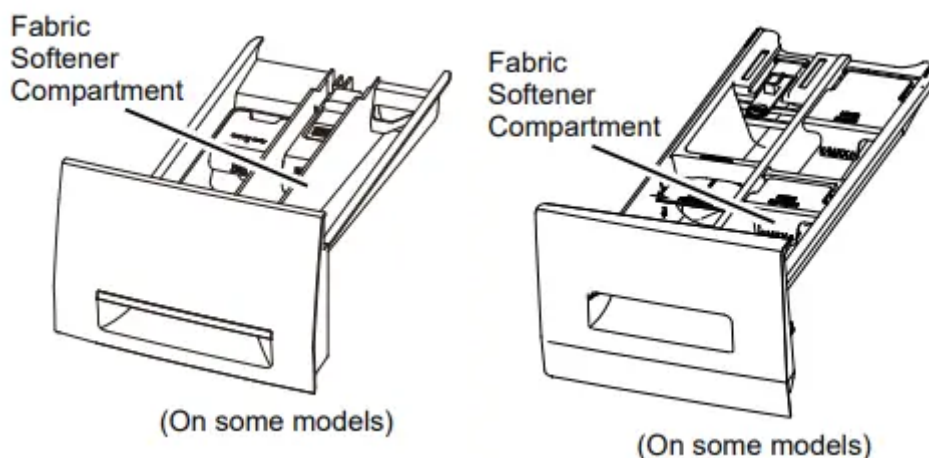

## Loading

Always follow fabric manufacturer's care label when laundering.

## Sorting Wash Loads

Sort by color (whites, lights, colors), soil level, fabric type (sturdy cottons, easy care, delicates) and whether the fabric produces lint (terry cloth, chenille) or collects lint (velveteen, corduroy). Wash lint producers such as cotton towels and socks separate from lint collectors including synthetic garments and dress pants.



DO NOT wash fabrics soiled with flammable liquids or cleaning solvents.

No washer can completely remove oil.

DO NOT wash or dry anything that has been soaked in or spotted with any type of oil (including cooking oils).

DO NOT reach into the washer until all moving parts have stopped.

Doing so can result in death, explosion, fire or amputation.

## Loading the Washer

The wash drum may be fully loaded with loosely added items.

To add items after the washer has started, press Start/Pause and wait until the door is unlatched. The washer may take up to 30 seconds to unlock the door after pressing Start/Pause, depending on the machine conditions. Do not try to force open the door when it is locked. After the door unlocks, open gently. Add items, close the door and press Start/Pause to restart.

The wash drum may be fully loaded with loosely added items.

### Loading Examples

WORKWEAR	LINENS	MIXED LOAD	DELICATES*	QUICK WASH (2-3 GARMENTS)
3 Jeans 3 Work Wear Shirts 2 Work Wear Pants	1 Bath Sheet 6 Bath Towels/ 8 Washcloths 4 Hand Towels/ 1 Terrycloth Bath Mat <b>OR</b> 1 Flat Queen-Sized Sheet 1 Fitted Queen-Sized Sheet 2 Pillowcases	2 Pillowcases 1 Hand Towel 1 Flat Sheet/ 1 Fitted Sheet 2 Bath Towels/ 2 Washcloths <b>OR</b> 4 Shirts (Men's or Women's) 3 Pair Pants (Khakis or Twills) 3 T-shirts 4 Pairs of Boxers 2 Pairs of Shorts <b>OR</b> 4 T-shirts 2 Pairs of Sweatpants 2 Sweatshirts 1 Hoodie 5 Pairs of Socks	4 Bras 4 panties 2 Slips 1 Camisole 3 Nightgowns *Using a nylon mesh bag for small items is recommended.	2 Casual Wear Work Shirts 1 Pair Casual Wear Work Pants <b>OR</b> 3 Soccer Uniforms

## CARE AND CLEANING

### Water Supply Hoses

Hoses connecting washer to faucet should be replaced every 5 years.

### Exterior

Immediately wipe off any spills. Wipe with damp cloth. Wipe or dust spills or washing compounds with a damp cloth. Washer control panel and finishes may be damaged by some laundry pretreatment and stain remover products. Apply these products away from the washer. The fabric may then be washed and dried normally. Damage to your washer caused by these products is not covered by your warranty. Do not hit surface with sharp objects.

### Interior

Dry around the washer door opening, flexible gasket (including attached hoses) and door glass. These areas should always be clean to ensure a watertight seal.

It is recommended to rinse the washer at least once per month with 1 cup of bleach (or other commercially available product manufactured for this purpose, such as Tide® Washing Machine Cleaner) poured directly into the basket without clothes and using the Tub Clean Cycle.

### Pump Filter

Clean EVERY MONTH to remove any items that may have been caught in the filter or housing.

Due to the nature of the front-load washer, it is sometimes possible for small articles to pass to the pump. The washer has a filter to capture lost items so they are not dumped to the drain. To retrieve lost items, clean out the pump filter.

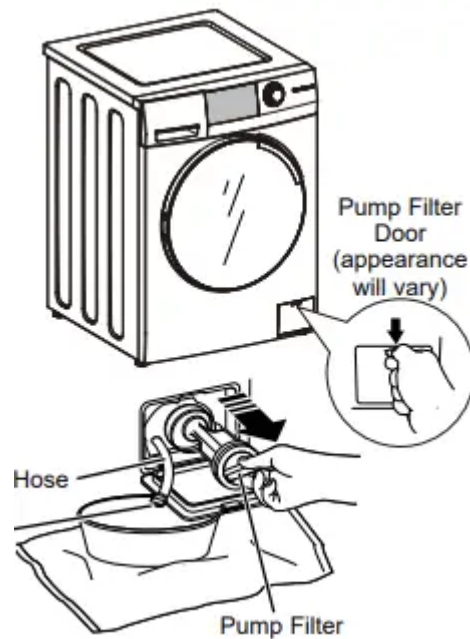

- 1 Open the door on the bottom right of the front of the unit.
- 2 Twist the small white cap counterclockwise a quarter turn and unhook the small rubber hose. Pull the hose out of the hole and remove the white drain hose plug above a small pan to capture any water that may drain. Drain the excess water. Replace.
- 3 Unscrew the pump filter. Rinse off any debris. Replace.
- 4 Close the access door.

## Door Gasket



Open the washer door. Using both hands, press down the door gasket. Remove any foreign objects if found trapped inside the gasket. Make sure there is nothing blocking the holes behind the gasket.

While holding down the door gasket, inspect the interior of the gasket by pulling it down with your fingers. Remove any foreign objects if found trapped inside this gasket. Make sure there is nothing blocking the holes behind the gasket.

When you are finished cleaning the door gasket, remove your hands and the gaskets will return to the operating position.

## Dispenser Drawer Area

Detergent and fabric softener may build up in the dispenser drawer. Residue should be removed once or twice a month.

- Remove the drawer by first pulling it out until it stops. Then reach back into the rear center of the drawer cavity and press down firmly on the lock tab, pulling out the drawer.

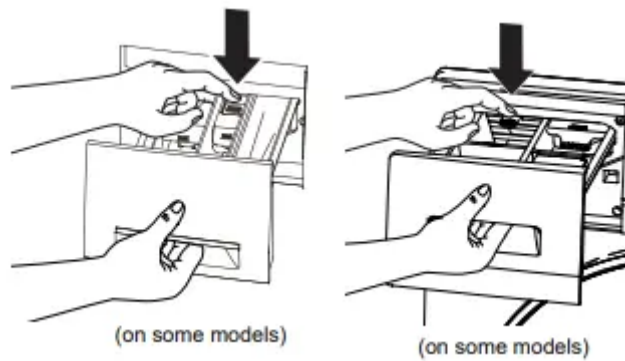

- Remove all cups and inserts from the dispenser drawer. Rinse the inserts, cups and drawer with hot water to remove traces of accumulated laundry products.

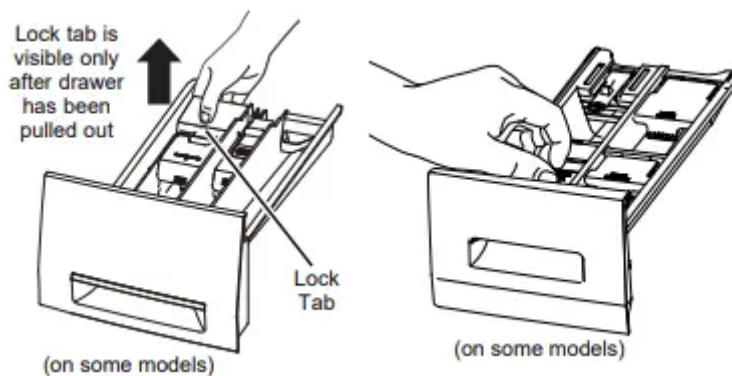

- To clean the drawer opening, use a small brush to clean the recess. Remove all residue from the upper and lower parts of the recess.
- Return inserts to the proper compartments. Replace the dispenser drawer.
- To reduce buildup in the Dispenser Drawer area:

Use only HE  
High-Efficiency  
detergent.

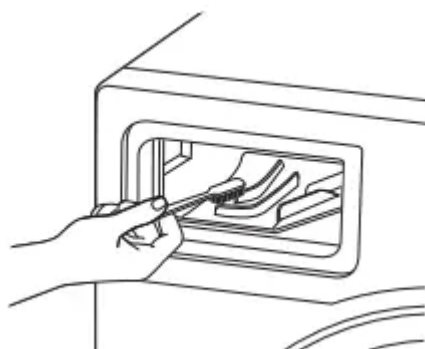

## Moving and Storage

Ask the service technician to remove water from drain pump and hoses. Do not store the washer where it will be exposed to the weather. When moving the washer, the tub should be kept stationary by using the shipping bolts removed during installation. See Installation Instructions in this manual. If these parts are not available, they can be ordered by visiting our Website at [GEApplianceparts.com](http://GEApplianceparts.com) or by calling GE Appliances at 877.959.8688. In Canada, visit your local GE Appliances parts distributor or call 800.661.1616 or [GEAppliances.ca/en/products/parts-filters-accessories](http://GEAppliances.ca/en/products/parts-filters-accessories).

## Long Vacations

Be sure water supply is shut off at faucets. Drain all water from hoses and water filter pump area if weather will be below freezing.

# Installation Instructions

## LOCATION OF YOUR WASHER

DO NOT Install the Washer:

1. In an area exposed to dripping water or outside weather conditions. The ambient temperature should never be below 60°F (15.6°C) for proper washer operation.
2. In an area where it will come in contact with curtains or drapes.
3. On carpet. The floor MUST be a hard surface with a maximum slope of 1/2" per foot (1.27 cm per 30 cm).

To make sure the washer does not vibrate or move, you may have to reinforce the floor.

**NOTE:** If floor is in poor condition, use 3/4" impregnated plywood sheet solidly attached to existing floor covering.

## IMPORTANT:

### Minimum Installation Clearances

- When installed in alcove: Sides/Rear = 0" and Top = 1"

- When installed in closet: Sides/Rear = 0" and Top/Front = 1" (2.54 cm)
- Consideration must be given to provide adequate clearance for installation and service.
- Closet doors must be louvered or otherwise ventilated and have at least 60 square inches (387.1 cm<sub>2</sub>) of open area. If the closet contains both a washer and a dryer, doors must contain a minimum of 120 square inches (774.2 cm<sub>2</sub>) of open area.

### CONNECTION DIMENSIONS

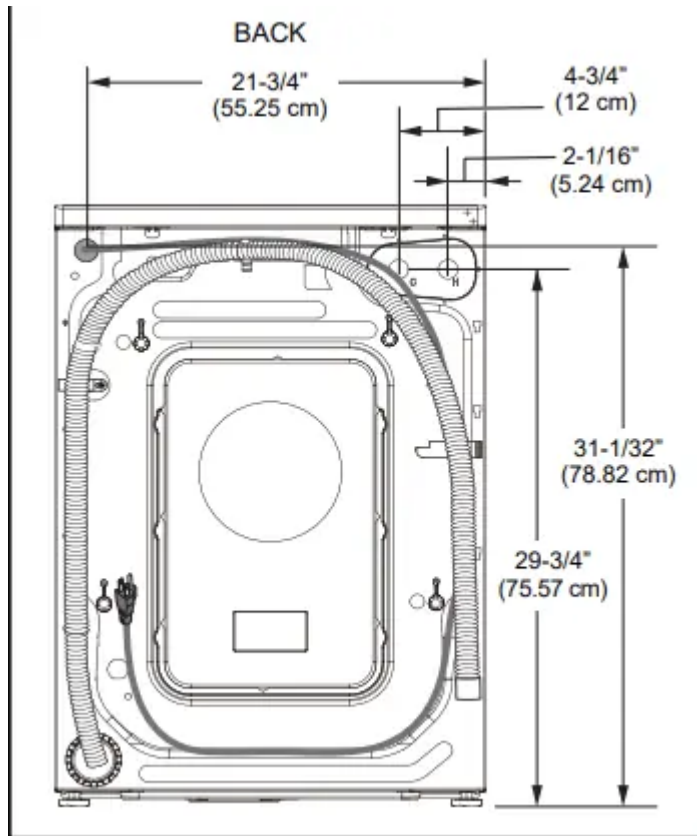

### ROUGH-IN DIMENSIONS

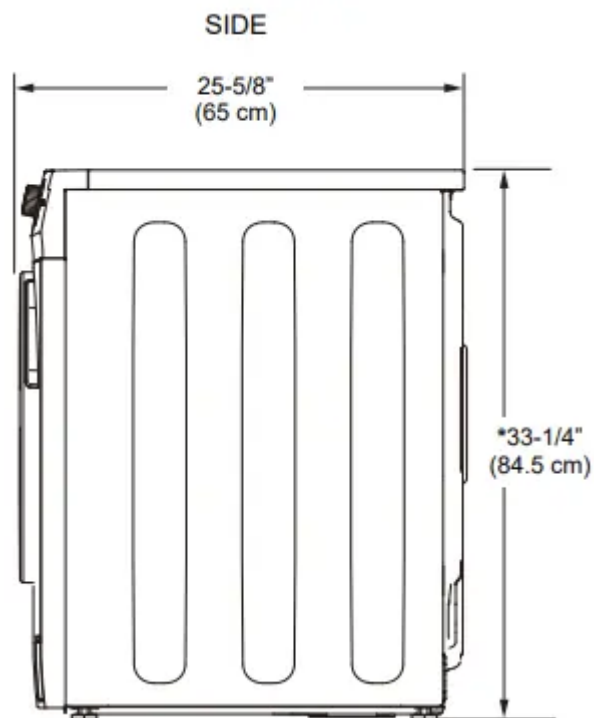
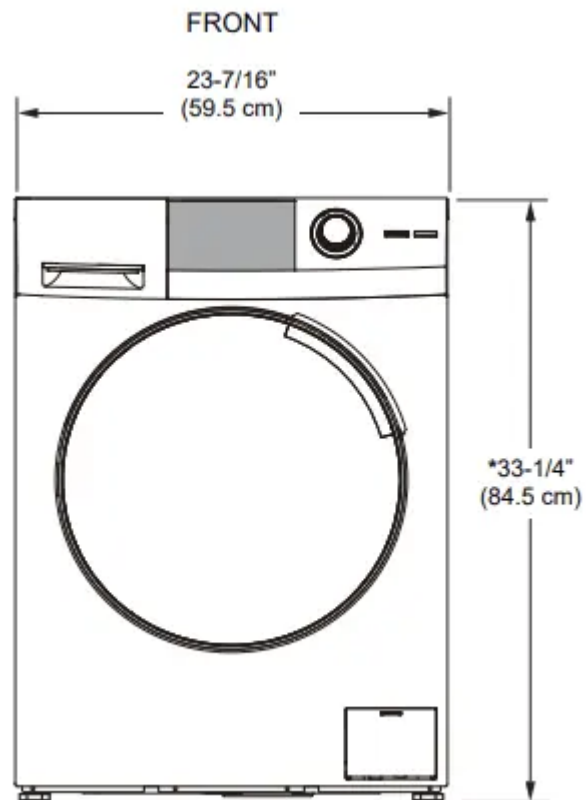

**\*NOTE:**

Washer leveling legs retracted = 33-1/4" (84.5 cm)

Washer leveling legs extended = 33-3/4" (85.5 cm)

Stacked = 66-1/2" (169.0 cm)



## UNPACKING THE WASHER

### **▲ WARNING**

Recycle or destroy the carton and plastic bags after the washer is unpacked. Make materials inaccessible to children. Children might use them for play. Cartons covered with rugs, bedspreads or plastic sheets can become airtight chambers causing suffocation.

1. Cut and remove all packaging straps.
2. While it is in the carton, carefully lay the washer on its side. DO NOT lay the washer on its front or back.
3. Turn down the bottom flaps. Remove all base packaging including the styrofoam base.
4. Carefully return the washer to an upright position and remove the carton by lifting it upward.
5. Carefully move the washer to within 4 feet (122 cm) of the final location.
6. Remove the following from the back side of the washer: 4 bolts 4 plastic spacers (including rubber grommets)

**NOTE:** Do NOT remove the screw or clip holding the hose.

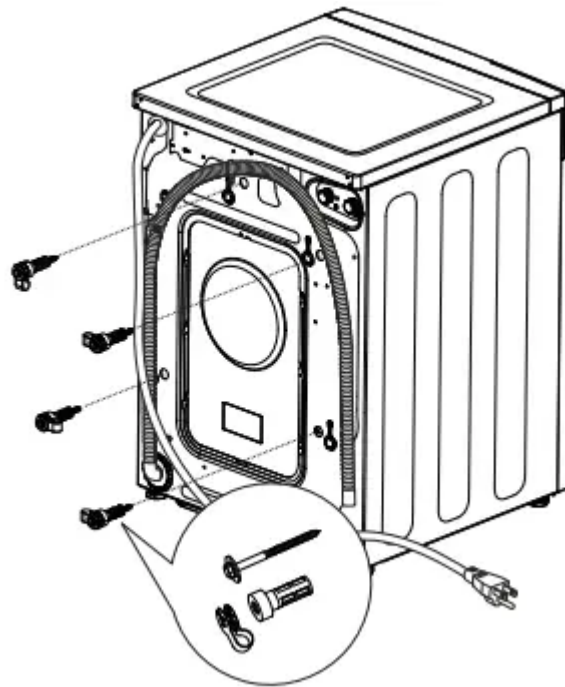

7. Insert shipping bolt hole covers into shipping bolt holes.

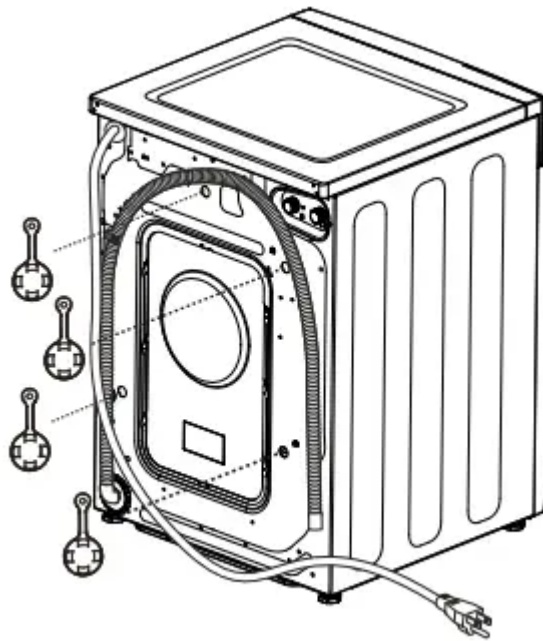

#### NOTES:

- Failure to remove the shipping braces can cause the washer to become severely unbalanced.
- **IMPORTANT:** Save all bolts for future use. If you must transport the washer at a later date, you must reinstall the shipping support hardware to prevent shipping damage. Keep the hardware in the plastic bag provided.

#### ELECTRICAL REQUIREMENTS

**⚠ WARNING**  - Electrical Shock Hazard

Plug into a grounded 3-prong outlet.

DO NOT remove ground prong.

DO NOT use an adapter.

DO NOT use an extension cord.

Failure to follow these instructions can result in death, fire or electrical shock.

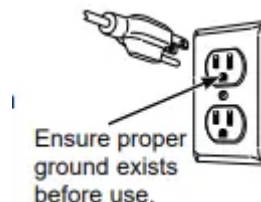

**CIRCUIT** – Individual, properly polarized and grounded 15 or 20 amp circuit breaker or time-delay fuse.

**POWER SUPPLY** – 2 wire plus ground, 120 Volt, single phase, 60 Hz, alternating current.

**Outlet Receptacle** – Properly grounded 3-prong receptacle to be located so the power cord is accessible when the washer is in an installed position. If a 2-prong receptacle is present, it is the owner's responsibility to have a licensed electrician replace it with a properly grounded 3-prong grounding type receptacle.

Washer must be electrically grounded in accordance with local codes and ordinances, or in the absence of local codes, with latest edition of the NATIONAL ELECTRICAL CODE, ANSI/NFPA NO. 70 or CANADIAN ELECTRICAL CODE, CSA C22.1. Check with a licensed electrician if you are not sure that the washer is properly grounded.

## GROUNDING INSTRUCTIONS

This appliance must be grounded. In the event of malfunction or breakdown, grounding will reduce the risk of electric shock by providing a path of least resistance for electric current. This appliance is equipped with a cord having an equipment- grounding conductor and a grounding plug. The plug must be plugged into an appropriate outlet that is properly installed and grounded in accordance with all local codes and ordinances

**▲ WARNING** Improper connection of the equipment grounding conductor can result in a risk of electrical shock. Check with a qualified electrician, or service representative or personnel, if you are in doubt as to whether the appliance is properly grounded. DO NOT modify the plug on the power supply cord. If it will not fit the outlet, have a proper outlet installed by a qualified electrician.

If required by local codes, an external 18 gauge or larger copper ground wire (not provided) may be added. Attach to washer cabinet with a #10-16 x 1/2" sheet metal screw (available at any hardware store) to rear of washer.

**▲ WARNING**  - Electrical Shock Hazard

Disconnect power supply before servicing. Replace all parts and panels before operating. Failure to do so can result in death or electrical shock.

**▲ WARNING** - Shock Hazard

Certain internal parts are intentionally not grounded and may present a risk of electric shock only during servicing.

Service personnel – DO NOT contact the following parts while the appliance is energized:  
Electrical Valve, Drain Pump, NTC and Motor Control Unit.

## WATER SUPPLY REQUIREMENTS

Hot and cold water faucets MUST be installed within 42 inches (107 cm) of your washer's water inlet. The faucets MUST be 3/4" (1.9 cm) garden hose-type so inlet hoses can be connected. Water pressure MUST be between 10 and 120 pounds per square inch. Your water department

can advise you of your water pressure. The hot water temperature should be set to deliver water at 120° to 140°F (48°–60°C) to provide proper Automatic Temperature Control (ATC) performance.

## DRAIN REQUIREMENTS

1. Drain capable of eliminating 9.5 gals (36 L) per minute.
2. A standpipe diameter of 1-1/4" (3.18 cm) minimum.
3. The standpipe height above the floor should be: Minimum height: 36" (91.4 cm) Maximum height: 58" (147 cm)

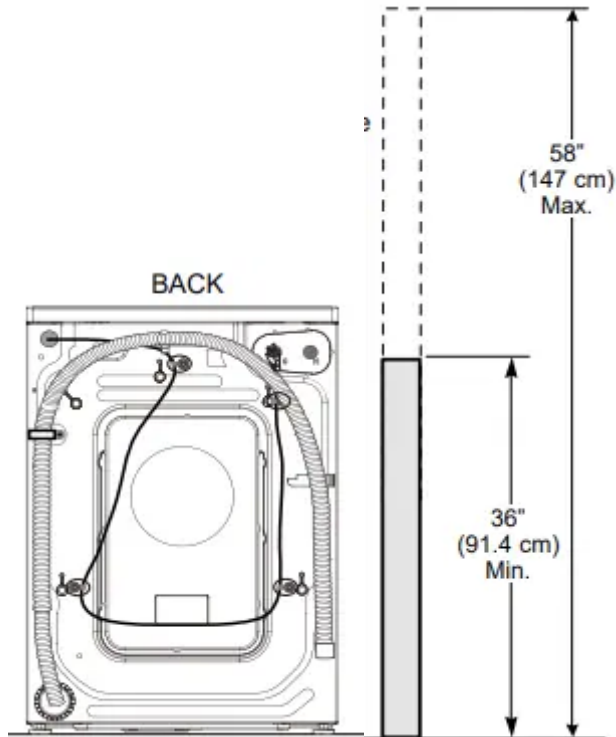

## INSTALLING THE WASHER

1. Run some water from the hot and cold faucets to flush the water lines and remove particles that might clog the water valve screens.
2. Remove the inlet hoses from the plastic bag. Remove black rubber washers from bag and insert into hose fitting before connecting to unit.
3. (90° elbow end) Carefully connect the inlet hose marked HOT to the outside "H" outlet of the water valve. Tighten by hand; then tighten another 2/3 turn with pliers. Carefully connect the other inlet hose to the inside "C" outlet of the water valve. Tighten by hand; then tighten another 2/3 turn with pliers. Do not crossthread or overtighten these connections.



4. Connect the inlet hose ends to the HOT and COLD water faucets tightly by hand; then tighten another 2/3 turn with pliers. Turn the water on and check for leaks.



5. Carefully move the washer to its final location. Gently rock the washer into position. It is important not to damage the rubber leveling legs when moving your washer to its final location. Damaged legs can increase washer vibration. It may be helpful to spray window cleaner on the floor to help move your washer into its final position.

NOTE: To reduce vibration, ensure that all four rubber leveling legs are firmly touching the floor. Push and pull on the back right and then back left of your washer.

NOTE: Do not use the dispenser drawer or door to lift the washer.

NOTE: If you are installing into a drain pan, you can use a 24-inch-long 2x4 to lever the washer into place.

6. With the washer in its final position, place a level on top of the washer (if the washer is installed under a counter, the washer should not be able to rock). Adjust the front leveling legs up or down to ensure the washer is resting solidly. Turn the locknuts on each leg up toward the base of the washer and snug with a wrench.

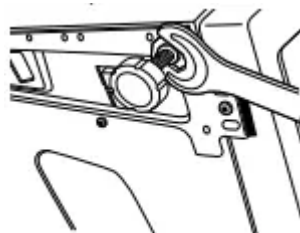

NOTE: Keep the leg extension at a minimum to prevent excessive vibration. The farther out the legs are extended, the more the washer will vibrate. If the floor is not level or is damaged, you may have to extend the rear leveling legs.

7. Attach U-shaped hose guide to the end of the drain hose. Place the hose in a laundry tub or standpipe.

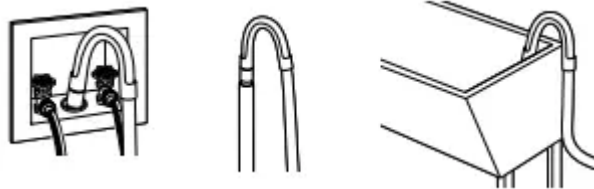

**NOTE:** If the drain hose is placed in a standpipe without forming a U shape, a siphoning action could occur. There must be an air gap around the drain hose. A snug hose fit can also cause a siphoning action.

**NOTE:** Do not place drain hose deeper than 7" into the drain. 4" - 7" is suggested. Deeper than 7" can cause a siphoning action.

8. Plug the power cord into a grounded outlet.

**NOTE:** Check to be sure the power is off at the circuit breaker/fuse box before plugging the power cord into an outlet.

9. Turn on the power at the circuit breaker/fuse box.

10. Read the rest of this Owner's Manual. It contains valuable and helpful information that will save you time and money.

11. Before starting the washer, check to make sure:

- Main power is turned on.
- The washer is plugged in.
- The water faucets are turned on.
- The unit is level and all four leveling legs are firmly on the floor.
- The shipping support hardware is removed and saved.
- The drain hose is properly tied up.
- There are no leaks at the faucet, drain line or washer

12. Run the washer through a complete cycle. Check for water leaks and proper operation.

13. If your washer does not operate, please review the Troubleshooting Tips section before calling for service.

14. Place these instructions in a location near the washer for future reference.

## **Troubleshooting Tips... Before you call for service**

**Not draining**

**Not spinning**

**Not tumbling**

Load is out of balance

- Redistribute clothes and run Rinse+Spin. Increase load size if washing small load containing heavy and light items.

Pump filter may be clogged

- See the Care and Cleaning section on how to clean the Pump Filter.

Drain hose is kinked or improperly connected

- Straighten drain hose and make sure washer is not sitting on it.

Household drain may be clogged

- Check household plumbing. You may need to call a plumber.

Drain hose siphoning; drain hose pushed too far down the drain

- Ensure there is an air gap between hose and drain.

### **Leaking water**

Door gasket is damaged

- Check to see if gasket is seated and not torn. Objects left in pockets may cause damage to the washer (nails, screws, pens, pencils) Water may drip from the door when the door is opened. This is a normal operation. Carefully wipe off rubber door seal. Sometimes dirt or clothing is left in this seal and can cause a small leak

Check back left of washer for water

- If this area is wet, you have oversudsing condition. Use less detergent.

Fill hoses or drain hose is improperly connected

- Make sure hose connections are tight at washer and faucets and make sure end of drain hose is correctly inserted in and secured to drain facility.

Household drain may be clogged

- Check household plumbing. You may need to call a plumber.

Dispenser clogged

- Powder soap may cause clogs inside the dispenser and cause water to leak out the front of the dispenser. Remove drawer and clean both drawer and inside of dispenser box. Please refer to Care and Cleaning section.

Incorrect use of detergent

- Use only HE and correct amount of detergent.

### **Clothes too wet**

Load is out of balance

- Redistribute clothes and run Rinse+Spin.
- Increase load size if washing small load containing heavy and light items.

Pump filter may be clogged

- See the Care and Cleaning section on how to clean the Pump Filter.

Overloading

- Load your washer so clothes have enough room to move freely.

Drain hose is kinked or improperly connected

- Straighten drain hose and make sure washer is not sitting on it.

Household drain may be clogged

- Check household plumbing. You may need to call a plumber.

Drain hose siphoning; drain hose pushed too far down the drain

- Ensure there is an air gap between hose and drain.

### **Incomplete cycle or timer not advancing**

Automatic load redistribution

- Timer stops at 1 minute; machine has redistributed the load once or twice. This is normal operation. Do nothing; the machine will finish the wash cycle.

Pump filter may be clogged

- See the Care and Cleaning section on how to clean the Pump Filter.

Drain hose is kinked or improperly connected

- Straighten drain hose and make sure washer is not sitting on it.

Household drain may be clogged

- Check household plumbing. You may need to call a plumber.

Drain hose siphoning; drain hose pushed too far down the drain

- Ensure there is an air gap between hose and drain.

### **Loud or unusual noise; vibration or shaking**

Cabinet moving

- Washer is designed to move 1/4" to reduce forces transmitted to the floor. This movement is normal.

All rubber leveling legs are not firmly touching the floor

- Push and pull on the back right and then back left of your washer to check if it is level. If the washer is uneven, adjust the rubber leveling legs so they are all firmly touching the floor and locked in place.

Unbalanced load

- Pause unit, open door and manually redistribute load. To check machine, run rinse and spin with no load. If normal, unbalance was caused by load.

Pump filter may be clogged

- See the Care and Cleaning section on how to clean the Pump Filter.

### **No power/washer not working or dead**

Washer is unplugged

- Make sure cord is plugged securely into a working outlet.

Water supply is turned off

- Turn both hot and cold faucets fully on.

Circuit breaker/fuse is tripped/blown

- Check house circuit breakers/fuses. Replace fuses or reset breaker. Washer should have separate outlet.

Automatic self system checks

- First time the washer is plugged in, automatic checks occur. It may take up to 20 seconds before you can use your washer. This is normal operation.

### **Snags, holes, tears, rips or excessive wear**

Pens, pencils, nails, screws or other objects left in pockets

- Remove loose items from pockets.

Pins, snaps, hooks, sharp buttons, belt buckles, zippers and sharp objects left in pockets

- Fasten snaps, hooks, buttons and zippers.

### **Control time wrong or changes**

This is normal

- During spin the washer may need to rebalance the load sometimes to reduce vibrations. When this happens, the estimated time is increased causing time left to increase or jump.

### **Not enough water**

This is normal

- Horizontal washers do not require the tub to fill with water like top-load washers.

**Washer pauses or has to be restarted, or washer door is locked and will not open**

Pump filter may be clogged

- See the Care and Cleaning section on how to clean the Pump Filter.

**Door unlocks or press Start and machine doesn't operate**

This is normal

- Front-load washers start up differently than top-load washers, and it takes several seconds to check the system. The door will lock and unlock.

Incorrect operation

- Simply open and close the door firmly; then press Start.

**Water does not enter washer or enters slowly**

Automatic self system checks

- After Start is pressed, the washer does several system checks. Water will flow several seconds after Start is pressed.

Water valve screens are stopped up

- Turn off the water source and remove the water connection hoses from the upper back of the washer. Use a brush or toothpick to clean the screens in the machine. Reconnect the hoses and turn the water back on.

Inlet hose screen washers are stopped up

- Turn off the water source and remove the inlet hoses from the wall faucets. Use a brush or toothpick to clean the screen washers in the end of the hoses. Reconnect the hoses and turn the water back on.

Pump filter may be clogged

- See the Care and Cleaning section on how to clean the Pump Filter.

Fill hoses may be kinked

- Check that fill hoses are not kinked or clogged.

Water supply is turned off

- Turn on both hot and cold faucets fully.

Energy efficiency

- This is an energy-efficient washer. As a result, the temperature settings for this washer may be different than for a non-energyefficient washer.

#### Insufficient water supply

- Make sure that the water supply is turned on. Make sure that the water faucets are turned to their completely open position.

#### The washer door is open

- The washer door must be closed for all washer cycle operations. If the door is opened during the washer operation, all functions will stop, including water filling.

#### Incorrect fill hose connection

- Make sure that the fill hoses connect the hot water supply to the hot inlet on the washer and the cold water supply to the cold inlet on the washer (hot to hot, cold to cold).

### **Wrinkling**

#### Improper sorting

- Avoid mixing heavy items (like work clothes) with light items (like blouses).

#### Overloading

- Load your washer so clothes have enough room to move freely.

#### Incorrect wash cycle

- Match cycle selection to the type of fabric you are washing especially for easy care loads).

#### Repeated washing in water that is too hot

- Wash in warm or cold water.

### **Grayed or yellowed clothes**

#### Not enough detergent

- Use correct amount of detergent.

#### Not using HE (high efficiency) detergent

- Use only HE detergent.

#### Hard water

- Use hottest water safe for fabric.
- Use a water conditioner like Calgon brand or install a water softener.

#### Water is not hot enough

- Make sure water heater is delivering water at 120°–140°F (48°–60°C).

#### Detergent is not dissolving

- Try a liquid HE detergent.

Dye transfer

- Sort clothes by color. If fabric label states wash separately, unstable dyes may be indicated.

### **Colored spots**

Incorrect use of fabric softener

- Check fabric softener package for instructions and follow directions for using dispenser.

Dye transfer

- Sort whites or lightly colored items from dark colors.
- Promptly remove wash load from washer.

### **Water temperature is incorrect**

Water supply is improperly connected

- Make sure hoses are connected to correct faucets.

House water heater is not set properly

- Make sure house water heater is delivering water at 120°– 140°F (48°–60°C).

### **Slight variation in metallic color**

This is normal

- Due to the metallic properties of paint used for this unique product, slight variations of color may occur due to viewing angles and lighting conditions.

### **Bad odor inside your Washer**

Washer unused for a long time, not using recommended quality of HE detergent or used too much detergent

- Run a Tub Clean cycle.
- In case of strong odor, you may need to run the Tub Clean cycle more than once.
- Use only the amount of detergent recommended on the detergent container.
- Use only HE (high efficiency) detergent.
- Always remove wet items from the washer promptly after machine stops running.
- Leave the door slightly open for the water to air dry. Close supervision is necessary if this appliance is used by or near children. Do not allow children to play on or in this or any other appliance.

### **Detergent leak**

Incorrect placement of detergent insert

- Make sure detergent insert is properly located and fully seated. Never put detergent above max line.

This is normal

- It is normal operation to see detergent leak on door gasket about 20 seconds after filling the dispenser

### **Improper dispensing of softener**

Dispenser clogged

- Monthly clean the dispenser drawer to remove buildup of chemicals.

Softener is filled above the max line

- Make sure to have the correct amount of softener.

Softener cap issue

- Make sure softener cap for dispenser is seated or it will not work.

### **Dispenser drawer not dispensing properly**

Laundry detergent packet placed in dispenser drawer

- Laundry detergent packets should not be used in the dispenser. They should only be added directly to the wash tub following the manufacturer's directions.

### **Pump running while washer is not in use**

Clog in sump drain

- This is normal. Drain sump is detecting an undesired water fill level from a potential open faucet. Shut off water valve and inspect water valve for blockage.

#### **Warning**

This content is compiled from multiple sources and is provided for reference purposes only. It may not be complete or fully applicable to all situations. If you are unable to resolve your issue, please contact the product manufacturer or an authorized service provider for official support.