

Operating your French Door Refrigerator

USING THE CONTROL PANEL

RF28HFEDB* / RF28HFPDB*

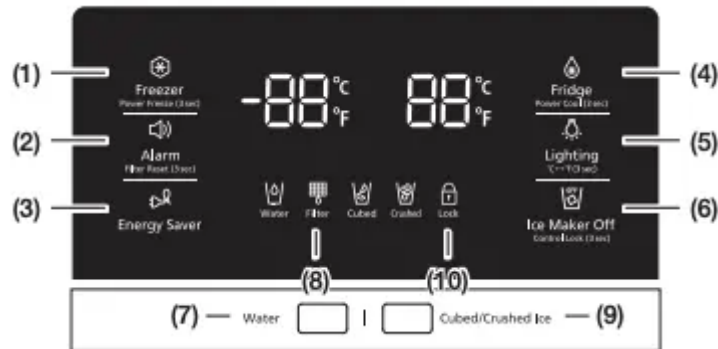

(1) Freezer / Power Freeze (3sec)

The Freezer button serves two purposes:

- To set the Freezer to your desired temperature.
- To turn the Power Freeze function on and off.

1. To set the Freezer temperature, touch the Freezer button.

You can set the temperature between 5 °F (-15 °C) and -8 °F (-23 °C).

2. Power Freeze function

Touch and hold this button for 3 seconds to decrease the time needed to freeze products in the Freezer. It can be helpful if you need to quickly freeze easily spoiled items or if the temperature in the freezer has warmed dramatically. (For example, if the door was left open.) When you use this function, the energy consumption of the refrigerator will increase. Remember to turn it off when you don't need it and return the freezer to your original temperature setting. If you need to freeze a large amount of food, activate the Power Freeze function at least 24 hours before you put the food into the freezer.

(2) Alarm / Filter Reset (3sec)

The Alarm button serves two purposes:

- To turn the door open alarm on and off
- To reset the water filter life indicator.

1. Door Alarm Function

If the door alarm is set to On, an alarm beeps if any refrigerator door is left open for more than three minutes. The beeping stops when you close the door. The door alarm function is pre-set to On in the factory. You can turn it off by pressing and then releasing the Alarm button. You can turn it back on in the same fashion. The icon lights up when the function is on. When the Door Alarm function is on and the alarm sound is triggered, the Door Alarm Icon will blink while the alarm sounds.

2. Water Filter Life Indicator Function

After you replace the water filter, touch and hold this button for 3 seconds to reset the water filter life indicator. When you reset the water filter life indicator, the Filter icon on the panel turns Off. The Filter icon will turn red to let you know it is time to change the water filter after six months (about 300 gallons). Some areas have large amounts of lime in their water, which causes the water filter to clog more quickly. If this is the case in your area, you will have to change the filter more frequently than every six months.



(3) Energy Saver

Touching this button turns Energy Saver mode on and off. When you turn Energy Saver on, the Energy Saver icon lights. Turn Energy Saver off and the icon goes off.

The Energy Saver function automatically turns on when power is supplied to the refrigerator. If condensation or water drops appear on the doors, turn the Energy Saver mode off.



(4) Fridge / Power Cool (3sec)

The Fridge button serves two purposes:

- To set the Fridge to your desired temperature.
- To turn the Power Cool function on and off.

1. To set the Fridge temperature, press the Fridge button.

You can set the temperature between 44 °F (7 °C) and 34 °F (1 °C).

2. Power Cool function

Touch and hold this button for 3 seconds to decrease the time needed to cool products in the Refrigerator. It can be helpful if you need to quickly cool easily spoiled items or if the temperature in the fridge has warmed dramatically. (for example, if the door was left open)



(5) Lighting / °C ↔ °F (3sec)

The Lighting button serves two purposes:

- To turn the dispenser light on and off

- To switch the temperature units between °C and °F.

1. Light Function

Touching the Lighting button turns on the Dispenser LED lamp in continuous mode so that it stays on continuously. The button also lights up. If you want the Dispenser lamp to come on only when someone uses the dispenser, press the Lighting button to turn the continuous mode off.

2. To switch the temperature units between °C and °F.

Touch and hold this button for 3 seconds to select the temperature display you want. Each time you press and hold the button, the °C and °F temperature modes alternate and the °C or °F icon lights up, indicating your selection.



(6), (11) **Ice Maker Off**

If you don't want to make more ice, touch the Ice Maker Off button. The icon will light up and the Ice-Maker stops making ice. We recommend you to stop ice making if the following occur:

- There is enough ice in the ice bucket.
- You want to save water and energy.
- Water is not being supplied to the refrigerator.

If the ice maker function is ON, and the water Line is not connected, there will be a water valve noise from the back of the unit. Press the Ice Maker Off (Control Lock (3sec)) button for less than 3 seconds until the Ice Off Indicator () illuminates.



(7) **Water**

Touch this button to dispense water. This mode can not be used with the Ice Type mode simultaneously. Water mode shuts off when you touch the Cubed / Crushed Ice button.

To save electricity, the Panel Display turns off automatically under the following conditions: When no button has been pressed, when no doors are open, or when no Dispenser Lever has been pushed. However, the icon indicating your cubed or crushed ice selection, will stay on. When you press a button, open a door, or push a Dispenser Lever, the Panel Display will turn on again.

Except for the Energy Saver, Water, and Cubed / Crushed Ice buttons, all function buttons will become operational after you remove your finger from the button you are currently pressing.



(8) Filter

Water filter usage

This icon lights up when you need to change the filter, usually after the refrigerator has dispensed about 300 gallons of water (after about 6 months). The icon will blink red for several seconds when you open or close the door. After you install the new water filter, reset the filter indicator by touching and holding the Hold 3sec for Filter Reset button for 3 seconds.

- If water is not dispensing or dispensing slowly, you need to replace the water filter because the water filter is clogged.
- Some areas have large amounts of lime in their water, which causes the water filter to clog more quickly.



(Cubed)



(9) (Crushed) Ice Type

Touch this button to select your desired ice type. Cubed and crushed ice modes alternate when you press the button. This mode can not be used with the Water mode simultaneously



(10) Ice Maker Off / Control Lock (3sec)

The Ice Maker Off button serves two purposes:

- To turn the Ice maker on and off
- To turn the Control Lock Function on and off.

1. Ice Off Function

If you don't want to make more ice, press the Ice Maker Off button.

2. Control Lock Function

Touch and hold this button for 3 seconds to lock the display and the dispenser buttons so the buttons can not be used. When Control Lock is on, the refrigerator does not dispense ice or water, even if the Dispenser Lever is pressed. The Control Lock icon lights up to indicate you've activated the Control Lock function. Press 3 seconds to unlock.



Cooling Off Mode

Cooling Off mode (also called Shop mode), is designed for use by retailers when they are displaying refrigerators on the shop floor.

In Cooling Off mode, the refrigerator's fan motor and lights work normally, but the compressors do not run, and the refrigerator and freezer do not get cold. To start Cooling Off mode, touch and hold the Freezer, Fridge and Alarm buttons for 5 seconds during normal operation. The refrigerator chime sounds and the temperature display flashes OFF. To cancel Cooling Off mode, touch and hold the Freezer, Fridge and Alarm buttons again for 5 seconds.

CHANGING THE WATER FILTER

 **WARNING** To reduce risk of water damage to your property DO NOT use generic brands of water filters in your SAMSUNG Refrigerator.

USE ONLY SAMSUNG BRAND WATER FILTERS. SAMSUNG is not legally responsible for any damage, including, but not limited to, property damage caused by water leakage from the use of a generic water filter.

SAMSUNG Refrigerators are designed to work ONLY WITH SAMSUNG Water Filters. The Filter light turns red to let you know when it is time to change your water filter cartridge. To give you time to get a new filter, the red light comes on just before the capacity of the current filter runs out. Changing the filter on time provides you with the freshest, cleanest water from your refrigerator.



(Red)

1. Shut off the water supply. Then, turn the water filter (1) about 1/4 turn, counter-clockwise.
2. Pull the water filter (1) from the case filter (2).

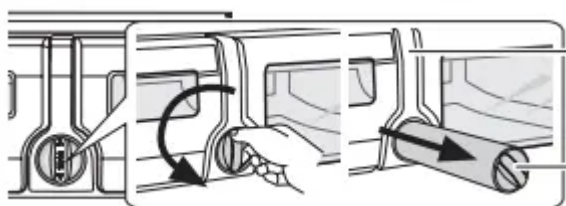



• To change the water filter more easily, shut off the water supply valve.

• Sometimes, it is hard to disassemble the water filter because impurities in the water cause it to stick. If you are having difficulties, grip the water filter firmly and pull it hard. • When you pull the water filter, a little water can leak from the opening. This is normal. To minimize the water leaks, keep the filter cartridge horizontal when you pull it.

• To prevent overflow, empty the water filter tray (3) and dry around the filter case (2).



3. Insert the new filter into the filter case (4).

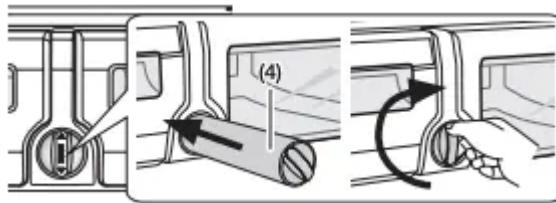

4. Push the filter, and then turn it clockwise until it locks.



• If you have trouble inserting the water filter because of high water pressure, shut off the water supply valve.

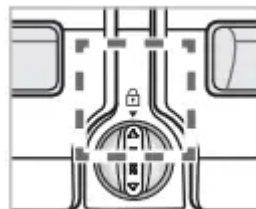

• The locked symbol should be lined up with the indicator line.

5. Touch and hold the “Alarm / hold 3 sec for Filter Reset” button () for about 3 seconds to reset the water filter indicator. The indicator’s red light will turn off.

6. If you turned off the water supply, turn it back on.

Removing any residual matter inside the water supply line after installing the water filter.

1. Turn ON the the water supply if you turned it off when you installed the water filter.

2. Run water through the dispenser until the water runs clear (approx. 6 to 7 minutes). This will clean the water supply system and remove air from the lines.

3. Additional flushing may be required in some households.

4. Open the Refrigerator door and make sure there are no water leaks coming from the water filter.

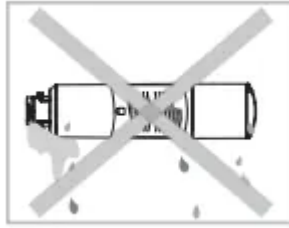

Be sure to flush the dispenser thoroughly, otherwise water may drip from the dispenser. This means that there is still air in the line.

Reverse Osmosis Water Supply IMPORTANT:

The pressure of the water supply coming out of a reverse osmosis system going to the water inlet valve of the refrigerator needs to be between 35 and 120 psi. (241 and 827 kPa)

If a reverse osmosis water filtration system is connected to your cold water supply, the water pressure to the reverse osmosis system needs to be a minimum of 40 to 60 psi. (276 to 414 kPa)

If the water pressure to the reverse osmosis system is less than 40 to 60 psi (276 to 414 kPa):

- Check if the sediment filter in the reverse osmosis system is blocked. Replace the filter if necessary.
- Allow the storage tank on the reverse osmosis system to refill after heavy usage.
- If your refrigerator has a water filter, it may further reduce the water pressure when used in conjunction with a reverse osmosis system. Remove the water filter.

If you have questions about your water pressure, call a licensed, qualified plumber.

CONTROLLING THE TEMPERATURE

Basic temperature of Freezer and fridge compartments

The basic and recommended temperatures of the Freezer and Fridge compartments are 0 °F and 37 °F (or -18 °C and 3 °C) respectively. If the temperature of the Freezer and Fridge compartments are too high or low, adjust the temperature manually.

Controlling the Freezer temperature

RF28HFEDB* / RF28HFPDB*



Recommend Temp (Freezer) : 0 °F (or -18 °C)

The Freezer temperature can be set between -8 °F and 5 °F (or between -23 °C and -15 °C) to suit your particular needs. Press the Freezer button repeatedly until the desired temperature is shown in the temperature display. The temperature will change by 1 °F (or 1 °C) with each press. See below.

- Fahrenheit : 0 °F → -1 °F → -2 °F → -3 °F → -4 °F → -5 °F → -6 °F → -7 °F → -8 °F → 5 °F → 4 °F → 3 °F → 2 °F → 1 °F → 0 °F.
- Centigrade : -18 °C → -19 °C → -20 °C → -21 °C → -22 °C → -23 °C → -15 °C → -16 °C → -17 °C → -18 °C.

Keep in mind that foods such as ice cream may/ melt at 4 °F (or -15.5 °C). The temperature display will move sequentially from -8 °F to 5 °F (or from -23 °C to -15 °C).

Controlling the fridge temperature

RF28HFEDB* / RF28HFPDB*



Recommend Temp (Fridge) : 37 °F (or 3 °C)

The fridge temperature can be set between 34 °F and 44 °F (or between 1 °C and 7 °C) to suit your particular needs. Press the Fridge button repeatedly until the desired temperature is shown in the temperature display. The temperature will change by 1 °F (or 1 °C) with each press. See below.

- Fahrenheit : 37 °F → 36 °F → 35 °F → 34 °F → 44 °F → 43 °F → 42 °F → 41 °F → 40 °F → 39 °F → 38 °F → 37 °F.
- Centigrade : 3 °C → 2 °C → 1 °C → 7 °C → 6 °C → 5 °C → 4 °C → 3 °C.

The temperature control process for the Fridge works just like the Freezer process. Press the Fridge button to set your desired temperature. After a few seconds, the Fridge will begin adjusting towards the newly set temperature. This will be reflected in the digital display.



- The temperature of the Freezer or Fridge may rise when you open the doors too frequently, or if a large amount of warm or hot food is placed inside.
- A rise in temperature may cause the digital display to blink. Once the Freezer and Fridge temperature return to their normal set temperatures, the blinking will stop.
- If the blinking continues, you may need to reset the Refrigerator. Try unplugging the appliance, wait for around minutes and then plug the power cord back in.
- If there is a communication error between the Display and Main Controller, the Convertible Display light may blink. If the blinking continues for a long period of time, please contact a Samsung Electronics Service Center

USING THE COLD WATER DISPENSER

Push the appropriate ice type button to select what you want dispensed.

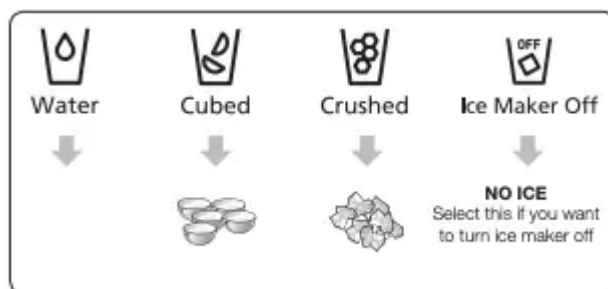

Using the ice Dispenser

Place a glass underneath the ice dispenser and push gently against the dispenser lever with your glass. Make sure the glass is in line with the dispenser to prevent the ice from bouncing out.



- To select water, press the water button on the display, and then press the dispenser lever.
- To select Ice, press the ICE type button of your choice on the display, and then press the dispenser lever.
- If you have selected cubed ice, when you press the lever, the dispenser may dispense a small amount of crushed ice first.

- If ice doesn't come out, pull out the ice bucket and press the test button located on the right side of ice maker.

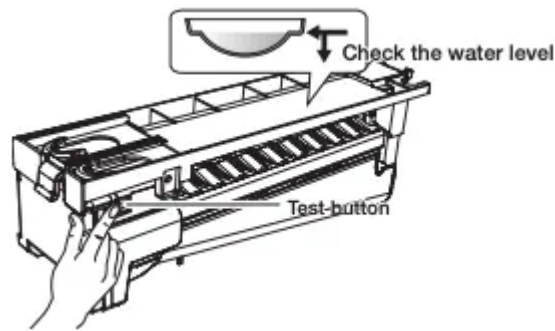

- Do not press the test button continuously when the tray is filled with ice or water. Water may overflow or ice may jam the bucket.
- When you press the Test button, you will hear the refrigerator chime (ding-dong). When the chime sounds, release the Test button.
- The chime sounds automatically again to let you know the ice maker is working well.
- Replace the ice bucket.

Ice Making

To fill the ice bucket to maximum capacity after installation, follow these steps:

1. Allow your refrigerator to operate and cool down for 24 hours (or 1 full day).
 - Waiting 24 hours will allow your ice maker to cool properly.
2. Dispense 4 to 6 ice cubes into a glass.
3. After 8, and then 16 hours, dispense a full glass of ice.

CAUTION

- To clean the ice bin/bucket, wash with a mild detergent, rinse well, and then dry it thoroughly. Do not use harsh or abrasive cleaners or solvents.
- When you select Cubed Ice after using the Crushed Ice mode, a small amount of residual crushed ice might be produced.

If There is a Power Failure

If a power failure occurs, ice cubes may melt, and then freeze together when the power comes back on, preventing the dispenser from working properly.

To prevent this problem, after a power failure, pull out the ice bucket and discard the residual ice or water.

After you dump the ice from the ice bucket, you should press the dispenser lever once with the 'Water' or 'Ice Type' function ON. The ice maker will make new ice faster after you return the ice bucket to the refrigerator.

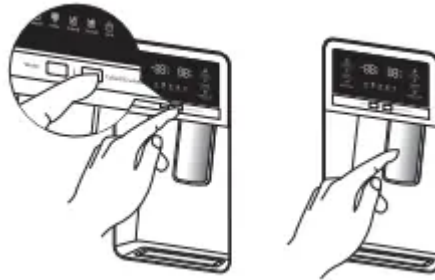

If you use all the ice at once, you must repeat Steps 2 and 3 under Ice Making. However, only wait 8 hours before dispensing the first 4 to 6 ice cubes. This will replenish the ice cubes and ensure maximum ice production.

Using the ice off Function

When you select the Ice Off mode, remove all ice cubes from the bucket. If you leave the ice cubes in the bucket, the ice cubes may clump together, making it difficult to remove them. To remove the ice bucket safely and avoid injury, hold the bottom of the bucket with one hand and the side of the bucket with the other. Then, lift up on the ice bucket, and pull it straight out. To put the ice bucket back in, push it firmly straight back.



If the ice bucket is not pushed firmly into place, ice in the bucket can melt.

If the bucket does not fit, turn the helix 90 degree (see the last illustration on the right, below) and try again.

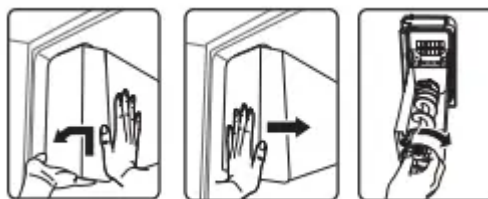

CAUTION

- Use only the ice maker provided with the refrigerator.
- Have the refrigerator's water supply connected only to a potable water supply.
- To operate the ice maker properly, water pressure of 20 ~ 125 psi is required.

Going on vacation...

If you are going on a long vacation or business trip and won't use the water or ice dispensers for a long time:

- Close the water valve. Otherwise, water leakage may occur.
- Remove all food and ice in the ice bucket.
- Unplug the refrigerator.
- Wipe excess moisture from inside and leave the doors open. Otherwise, odor and mold may develop.

Ice Maker Do's and Don'ts

- Do not put your fingers, hands or any other unsuitable objects in the chute or ice-maker bucket.
 - It may result in personal injury or material damage.
- Never put your finger or any other objects in the dispenser opening.
 - It may cause injury.
- Do not try to disassemble the ice maker.
- Do not wash or spray the ice bucket with water while it is in the refrigerator. Remove it to clean it.

CAUTION

When you insert the Ice maker tray, be sure that the tray is well centered at the entrance. Otherwise, the tray may get stuck.

Water clouding phenomenon



All water provided to the refrigerator flows through the core filter which is an alkaline water filter. In the filtering process, the pressure of the water that has flowed out of the filter is increased, and the water becomes saturated with oxygen and nitrogen. When this water flows out into the air, the pressure plummets and the oxygen and nitrogen get supersaturated, which results in gas bubbles. The water may temporarily look misty or cloudy due to these oxygen bubbles. After a few seconds, the water will look clear.



Please wait 1 second before removing the cup after dispensing water to prevent spills. Do not pull out the lever dispenser after dispensing ice or water. It comes back automatically. Ice is made in cubes. When you select "Crushed", the ice maker grinds the ice cubes into crushed ice.

PARTS AND FEATURES

Review the illustration below to become more familiar with the parts and features of your refrigerator.

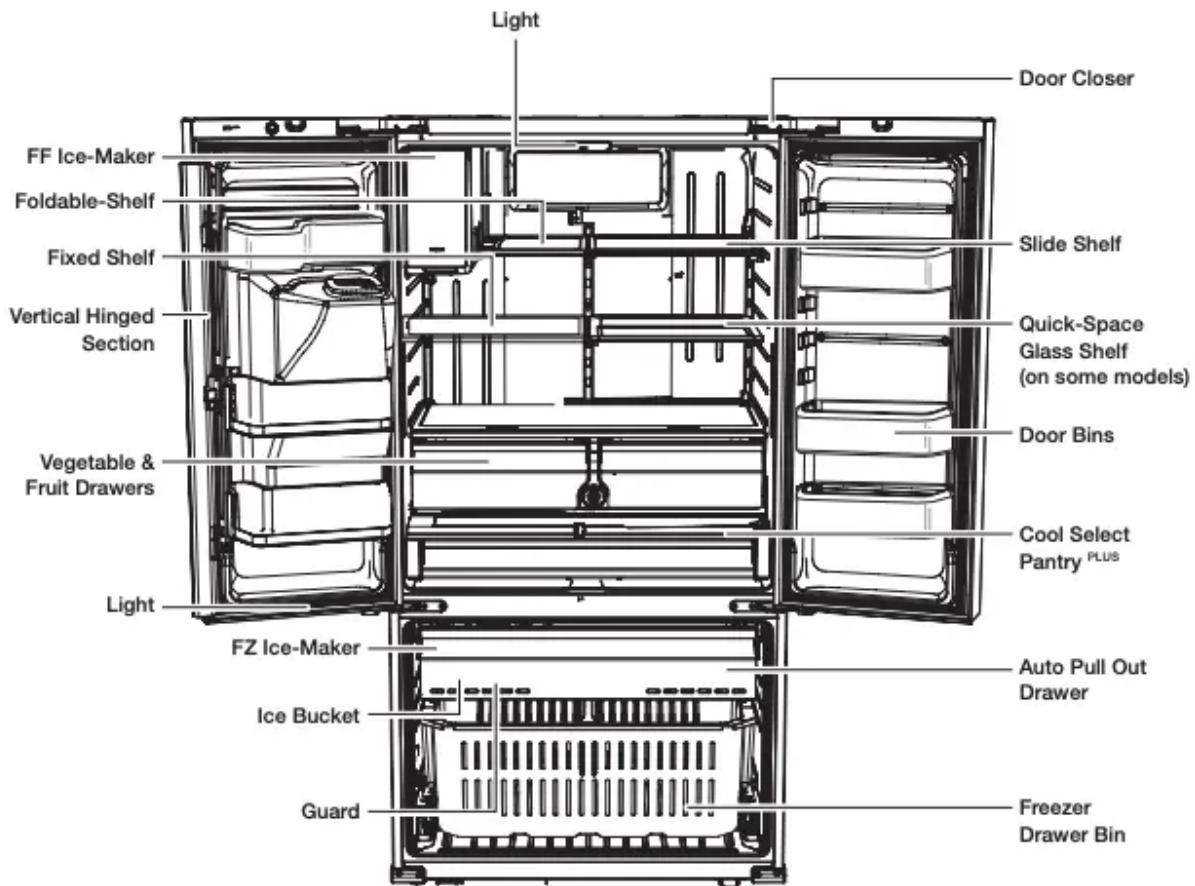

When closing the door, make sure the Vertical Hinged Section is in the correct position to avoid scratching the other door. If the Vertical Hinged Section is reversed, put it back to the right position and close the door. Moisture may appear at times on the Vertical Hinged Section. The door handle may become loose over time. If this happens, tighten the bolts found on the inside of the door. If you close one door with too much force, the other door may open.



When the door opens, the interlock switch automatically turns off the auger motor in the ice maker for safety reasons.



When the interior or exterior LED lamp has gone out, please contact Samsung Customer Support.

USING THE COOL SELECT PANTRY™

The Cool Select Pantry™ is a full-width drawer with adjustable temperature control. This pantry can be used for large party trays, deli items, pizza, beverages, or miscellaneous items. There is a temperature control which can adjust the amount of cold air allowed into the pantry. The control is located on the right side of the pantry.



- The Pantry has three modes: The Fresh mode, Chilled mode, and Deli mode. Fresh mode is the default. Press the Temp button repeatedly until the mode you want is lit. Once you select a mode, the temperature will change to match the mode you selected.
- The Pantry temperature may change depending on the number of items inside and where they are located, the ambient temperature, and how often the door is opened.

The Pantry Selection Button

1. When you select “Deli”, the temperature of the pantry will be kept around 41 °F (or 5 °C). This feature helps keep food fresh for a long time.
2. When you select “Fresh”, the temperature of the pantry will be kept around 38 °F (or 3 °C). This feature helps keep food fresh for a longer time.
3. When you select “Chilled”, the temperature of the pantry will be kept around 34 °F (or 1 °C). This feature also helps keep meat or fish fresh for a longer time. The table below lists the Pantry modes and the kinds of foods that can be stored safely for each mode.



Deli

- Pineapple
- lemon
- avocado
- potato

Fresh

- cucumbers
- apples
- oranges

- grapes
- zucchinis
- corn

Chilled

- steaks
- hard cheeses
- cold cuts
- bacon
- hot dogs



Fruits and vegetables may be damaged if you set the Pantry to the Chilled mode. Do not store lettuce or other leafy produce in this pantry.



CAUTION

Do not store glass bottles in the Cool Select Pantry. If they are freeze, they can break and cause personal injury.

REMOVING THE REFRIGERATOR ACCESSORIES

1. Door Bins

- Door Bins (1)
 - To remove : Simply lift the bin up and pull straight out
 - To relocate : Slide it in above the desired location and push down until it stops.
- Door Bins (2)
 - To remove : Take the right side of the bin out by lifting it at an angle along the guide, and then take the left side out by pulling it from the door.
 - To relocate : Slide it into the original location and push down until it sticks.

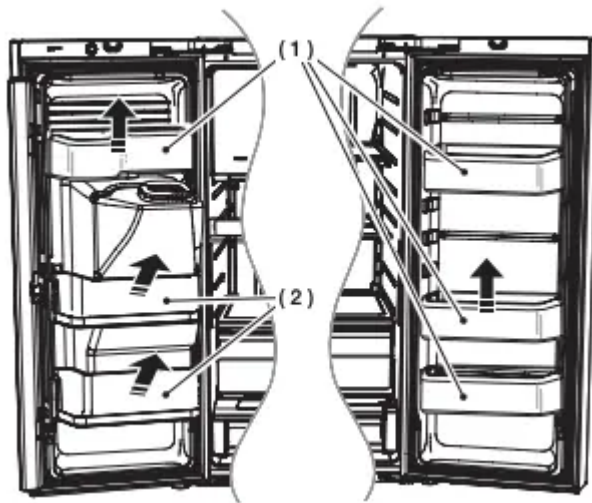

Injury may occur if the door bins are not firmly assembled. Do not allow children to play with the bins. Sharp corners of the bins may cause injury



CAUTION

Do not adjust a bin full of food. Remove the food first. To remove dust from the bins : Remove the guard and wash the bin in water.

2. Tempered Glass shelves

- To remove : Tilt up the front of the shelf in the direction shown (1) and lift it up vertically (2). Pull the shelf out.
- To relocate : Tilt the front of the shelf up and guide the shelf hooks into the slots at a desired height. Then lower the front of the shelf so that the hooks can drop into the slots.

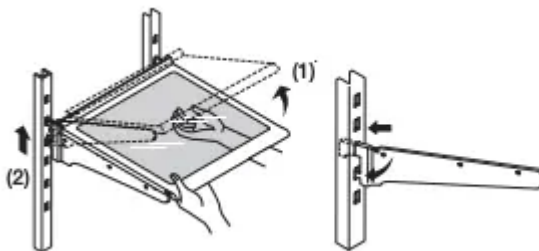

CAUTION

The Tempered Glass shelves are heavy. Use special care when removing them.



CAUTION

After sliding the foldable shelf in and folding it, the Shelf Front can be removed for your convenience. If you use the self without removing the Shelf Front, be aware the Shelf Front can separate from the shelf.

3. Vegetable & Fruit Drawers

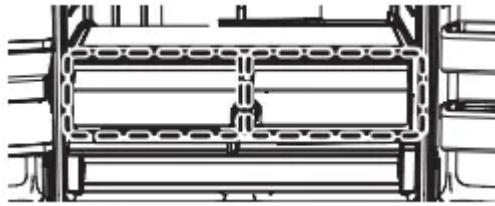

- Door Bins

Before removing the drawer, please remove door bins first as below.

To remove

- Simply lift the bin up and pull straight out.

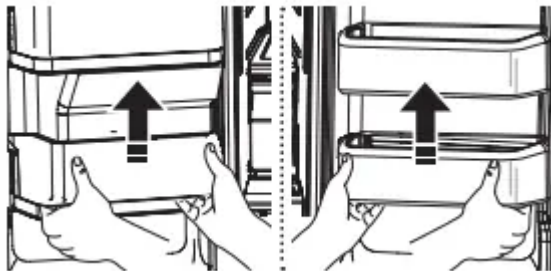

- Tilt up the front of the drawer and pull straight out, and pull out the drawer after moving slightly in the direction of the arrow.

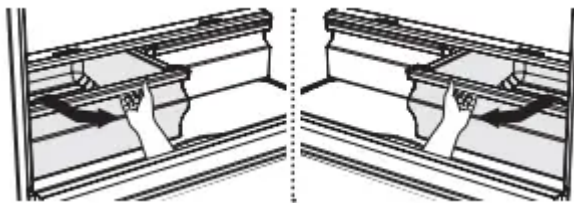

To re-install

- Insert the drawer into the frame rails and push back into place.
- Slide bin in above the desired location and push down until it stops.



CAUTION

The drawers need to be removed before the glass shelf above them can be lifted out.

4. Cool Select Pantry PLUS

- To remove the pantry : Pull the pantry out to full extension. Tilt up the front side of the pantry and pull straight out.
- To relocate the pantry : Push the rails to the back of the refrigerator. Place the drawer onto the rails and slide the pantry back until it is in place.

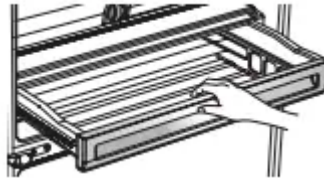

- To remove the divider : Pull the pantry completely out to full extension and raise the front side of the divider to unhook it from the rear wall of the pantry, then lift the divider out.
- To relocate the divider : Hook the back of the divider over the rear wall of the pantry and push the divider down.

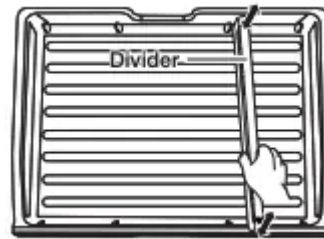

Using the doors

Ensure that the doors close all the way and are securely sealed. When the refrigerator door is only partially open, it will automatically close. But, the door will stay open when opened more than the auto close range and you must close it manually.

REMOVING THE FREEZER ACCESSORIES

1. Freezer Room Guard

- To remove : Remove the freezer room guard (1) by lifting the guard up.
- To relocate : Push down until the guard (1) locks into place. (1)

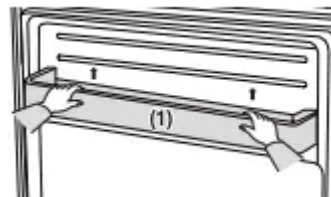

2. Ice Bucket

- To remove : Lift the ice bucket (1).
- To relocate : Place the ice bucket into the Super extended drawer (2).

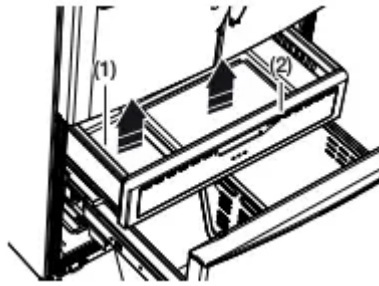

3. Super Extended Drawer

- To remove : Pull the drawer out to full extension. Tilt up the rear of the drawer and lift straight out.

- To relocate : Place the drawer onto the rails (4) by tilting it up.

Lower the drawer into place until it is horizontal and slide the drawer (3) in.

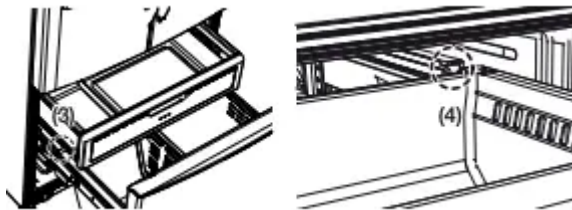

4. Freezer Drawer

- To remove the freezer drawer : Pull the freezer drawer out fully. Tilt up the rear of the bin and lift it out to remove.

- To relocate the freezer drawer : Place the bin into the rail assembly

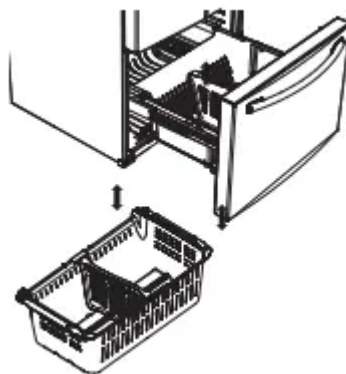

CAUTION

You can scratch the side of the bin if you twist it left or right when disassembling or re-assembling it.

CAUTION

Do not allow babies or children to climb into the freezer drawer.

They could damage the refrigerator and seriously injure themselves.

Do not sit on the freezer door.

The door may break.

 **CAUTION**

Do not remove the divider.

 **WARNING**

If trapped inside, children may be injured or suffocate to death.

CLEANING THE REFRIGERATOR

Caring for your Samsung French Door Refrigerator prolongs the life of your appliance and helps keep the refrigerator free of odor and germs.

Cleaning the Interior

Clean the inside walls and accessories with a mild detergent and then wipe dry with a soft cloth. You can remove the drawers and shelves for a more thorough cleaning. Just make sure to dry drawers and shelves before putting them back into place.

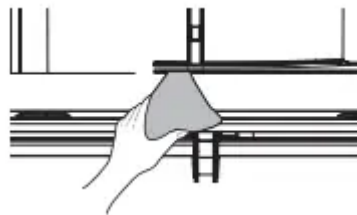

Cleaning the Exterior

Wipe the control panel and digital display with a damp, clean, soft cloth. Do not spray water directly on the surface of the refrigerator. The doors, handles, and cabinet surfaces should be cleaned with a mild detergent and then wiped dry with a soft cloth. To keep your appliance looking its best, polish the exterior once or twice a year.



 **CAUTION**

Do not spray water directly on the refrigerator. Use a clean, damp cloth to clean.

 **CAUTION**

Do not use benzene, thinner, or Clorox for cleaning. They may damage the surface of the appliance and may cause a fire.

 **CAUTION**

You can erase the printed letters on the display if you apply stainless cleaner directly to the area where the letters are printed.



Cleaning the Ice / Water Dispenser

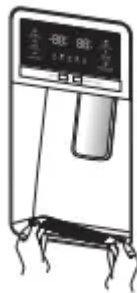

Push down one end of the tray dispenser and remove it. Wipe the Ice / Water Dispenser with a clean and soft cloth.

 **CAUTION**

As you use the dispenser's crushed ice selection, some residual ice chips may start to collect in the ice chute. To prevent that residual ice from melting and running out of the chute, you should clean out the residual ice when you see it start to collect in the ice chute.

Cleaning the Rubber door seals

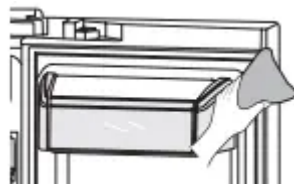

If the rubber door seals are dirty, the doors may not close properly, and the refrigerator will not operate efficiently. Keep the door seals free of dust or stains by cleaning the doors with a mild detergent and damp cloth. Wipe dry with a clean, soft cloth.

 **CAUTION**

Do not clean the refrigerator with benzene, thinner, or car detergent. These substances could cause a fire.

Cleaning the rear side of the refrigerator

To keep cords and exposed parts free of dust and dirt accumulation, vacuum the rear side of the appliance once or twice a year.

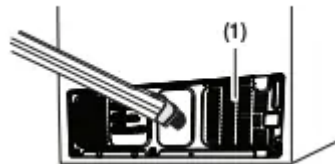

 **CAUTION** Do not remove the back cover (1). You could suffer an electric shock.

FOOD STORAGE TIPS

Foods	Refrigerator	Freezer	Storage Tips
DAIRY PRODUCTS			
Butter	2-3 Weeks	6-9 Months	Wrap or cover tightly.
Milk	1-2 Weeks	Not recommended	Check date code. Most milk and similar products are sold in date-coded cartons that indicate a product's peak freshness. Re-seal with cap or wrap tightly. Do not return unused portions to original container.
Cream Cheese, cheese food, and cheese spread	2-4 Weeks	Not recommended	Check date code. Keep all cheese tightly packed in moisture proof wrap
Hard Cheese (unopened)	3-4 Months	6 Months	
Hard Cheese (opened)	2 Months	Not recommended	
Cottage Cheese	10-15 Days	Not recommended	
Cream	7-10 Days	2 Months	Check date code. Most yogurt, creams, and similar products are sold in date-coded cartons that indicate a product's peak freshness. Re-seal or cover tightly. Do not return unused portions to original container.
Sour Cream	2 Weeks	Not recommended	
Cream Dips (opened)	1 Week	Not recommended	Check date code. Keep covered.
Yogurt	10-14 Days	Not recommended	
Frozen Yogurt	na	2 Months	
EGGS			
Eggs (uncooked)	3-4 Weeks	Not recommended	Check date code. Store eggs in coldest part of refrigerator and in their original container.
Eggs (cooked)	1 Week	Not recommended	Store in covered container
Leftover egg dishes	3-4 Days	Not recommended	Store in covered container
FRESH FRUITS			
Apples	1 Month	Not recommended	If storing in refrigerator, do not wash fruit before storing. Store in moisture resistant bags or containers. Wrap cut fruits. Some fruits darken when refrigerated.
Bananas	2-4 Days	Not recommended	
Peaches, Melons, Pears, Avocados	3-5 Days	Not recommended	
Berries and Cherries	2-3 Days	12 Months	
Apricots	3-5 Days	Not recommended	
Grapes	2-5 Days	na	
Pineapple (un-cut)	2-3 Days	Not recommended	
Pineapple (cut)	5-7 Days	6-12 Months	
Citrus	1-2 Weeks	Not recommended	Store uncovered.
Juice	6 Days	Not recommended	Check date code and re-seal in original container. Do not return unused portions to original container.
Frozen Juice	Thawing only	12 Months	Check date code. Do not re-freeze.
FISH AND SHELLFISH			
Fish			
Fatty Fish (mackerel, trout, salmon)	1-2 Days	2-3 Months	Keep in original wrapper and store in coldest part of refrigerator. Package in vapor-proof and moisture proof wrap for freezer. Freeze at 0 °F (or -18 °C). Thaw in refrigerator or check date code. Freeze in original packaging.
Lean Fish (cod, flounder, etc)	1-2 Days	6 Months	
Frozen or Breaded	na	3 Months	

Foods	Refrigerator	Freezer	Storage Tips
Shellfish			
Shrimp (uncooked)	1-2 Days	12 Months	To freeze, package in vapor-proof and moisture-proof container.
Crab	3-5 Days	10 Months	
Cooked Fish or Shellfish	2-3 Days	3 Months	
MEAT			
Fresh, Uncooked			
Chops	2-4 Days	6-12 Months	Check date code for use. Store in coldest part of refrigerator in original packaging. Package in moisture-proof and vapor-proof container for freezing. Recommended refrigerator temperature 33 °F to 36 °F (or 1 °C to 2 °C) and freezer temperature 0 °F to 2 °F (or -18 °C to -16 °C)
Ground	1 Day	3-4 Months	
Roast	2-4 Days	6-12 Months	
Bacon	1-2 Weeks	1-2 Months	
Sausage	1-2 Days	1-2 Months	
Steak	2-4 Days	6-9 Months	
Poultry	1 Day	12 Months	
Lunch meat	3-5 Days	1 Month	
Cooked			
Meat	2-3 Days	2-3 Months	Check date code for use. Store in coldest part of refrigerator in original packaging. Package in moisture-proof and vapor-proof container for freezing.
Poultry	2-3 Days	4-5 Months	
Ham	1-2 weeks	1-2 Months	

Sources:

American Meat Institute Foundation. 1994. Yellow pages: answers to predictable questions consumers ask about meat and poultry. American Meat Institute Food Marketing Institute. 1999. The food keeper. Food Marketing Institute, Washington, D.C. Freeland-Graves, J.H. and G.C. Peckham. 1996. Foundations of food preparation, 6th ed. Prentice-Hall, Inc. Englewood Cliffs, NJ. Hillers, V.N. 1993. Storing foods at home. Washington State University Cooperative Extension, Pullman, WA. Publ. EB 1205. National Restaurant Association. 2001. Be cool-chill out! Refrigerate promptly. National Restaurant Association Education Foundation¹/₄s International Food Safety Council, Washington, D.C. USDA. 1997. Basics for handling food safely. U.S. Department of Agriculture, Food Safety and Inspection Service, Washington, D.C.

Troubleshooting

The refrigerator does not work at all or it does not chill sufficiently.

- Check if the power plug is properly connected.
- Check if the set temperature on the digital display is warmer than the freezer or fridge inner temperature. If it is, set the freezer or fridge to a colder temperature.
- Is the refrigerator in direct sunlight or located near a heat source? If so, it may not be able to cool sufficiently. Install it in a location that is out of direct sunlight and not near a heat source.
- Is the back of the refrigerator too close to the wall, preventing proper ventilation? If so, it may not be able to cool sufficiently. Keep it an appropriate distance from the wall.
- Is there too much food inside so that the food is blocking the outlet vent? To keep the refrigerator at a suitable temperature, do not fill the refrigerator with too much food.

The food in the fridge is frozen.

- Check if the set temperature on the digital display is too low. If so, raise the set temperature inside the refrigerator.
- Is the temperature in the room too low? Set the refrigerator warmer.
- Did you store food with a high moisture content in the coldest part of the refrigerator or near the cooling outlet vent? Try moving those items to the other shelves in the fridge instead of keeping them in the colder areas or bins.

You hear unusual noise or sounds.

- Check if the refrigerator is level and stable.
- Is the back of the refrigerator too close to the wall, preventing proper ventilation?
- Was anything dropped behind or under the refrigerator?
- If you hear a “ticking” sound from inside the refrigerator, this is normal. It occurs because various parts contract or expand in response to temperature changes in the refrigerator interior.
- If it sounds as if something is hitting something else inside the refrigerator, this is normal. The sound is caused by the compressor operating at high capacity.

The cabinet-door sealing area of the appliance is hot and condensation is occurring.

- Some heat is normal as anti-condensators are installed in the vertical hinged section of the refrigerator to prevent condensation.
- Is the refrigerator door ajar? Condensation can occur when you leave the door open for a long time.

The ice Maker is not producing ice.

- It may take longer to make ice if it is not sufficiently cool, such as when first installed.
- Is the water line connected and the shut-off valve opened?
- Did you manually stop the ice making function?
- Check if the filter is properly installed. If it is not properly installed, the ice making function may not work.

You can hear water bubbling in the refrigerator.

- This is normal. The bubbling comes from refrigerant circulating through the refrigerator.

There is a bad smell in the refrigerator.

- Check for spoiled food.
- Foods with strong odors (for example, fish) should be tightly covered.

- Clean out the freezer periodically and throw away any spoiled food. When cleaning the inside of the fridge, store food elsewhere and unplug the appliance. Wipe with a dry dishcloth after 2-3 hours and then circulate air inside the refrigerator.

Frost forms on the walls of the freezer.

- Is the air vent blocked? Remove any obstructions so air can circulate freely.
- Allow sufficient space between the stored foods for efficient air circulation.
- Is the freezer drawer closed properly? If the freezer drawer is not completely closed or is blocked, humidity from outside may enter and cause severe frost to form.

The water dispenser is not functioning.

- Is the water line connected and the shut-off valve opened?
- Has the water supply line tubing been crushed or kinked?
- Make sure the tubing is free and clear of any obstruction.
- Is the water tank frozen because the fridge temperature is too low? Try selecting a warmer setting on the Digital display.
- Is the Child Lock on?
- Check if the filter is properly installed. If it is not properly installed, the water dispenser may not work.

The auto close system does not work with the freezer door.

- Is there an imbalance between the right and left parts of the door?
- Open and close the door smoothly 1~2 times. After you do this, the auto close system usually works properly again.
- Try opening the door smoothly to avoid unbalancing the right and the left part of the door.

Condensation or water drops forms on vertical mullion and surroundings, etc.

- Condensation or water drops may form if the humidity is too high while the refrigerator is operating.
- If condensation or water drops appears on vertical mullion and surroundings, etc., turn the Energy Saver mode off after removing the condensation. See the explanation of the Energy Saver button in “Using the control panel” on page

Warning

This content is compiled from multiple sources and is provided for reference purposes only. It may not be complete or fully applicable to all situations. If you are unable to resolve your issue, please contact the product manufacturer or an authorized service provider for official support.

