

USING THE RANGE

Surface Units

WARNING - FIRE HAZARD: Never leave the range unattended with the cooktop on medium or high settings. Keep flammable items away from the cooktop. Turn off all controls when done cooking. Failure to follow these instructions can result in fire, serious injury or death.

Throughout this manual, features and appearance may vary from your model.

How to Set

Push the knob in and turn in either direction to the setting you want.

A surface ON indicator light will glow when any surface unit is on

For glass cooktop surfaces:

A HOT COOKTOP indicator light will:

- come on when the unit is hot to touch.
- stay on even after the unit is turned off.
- stay on until the unit is cooled to approximately 150°F.

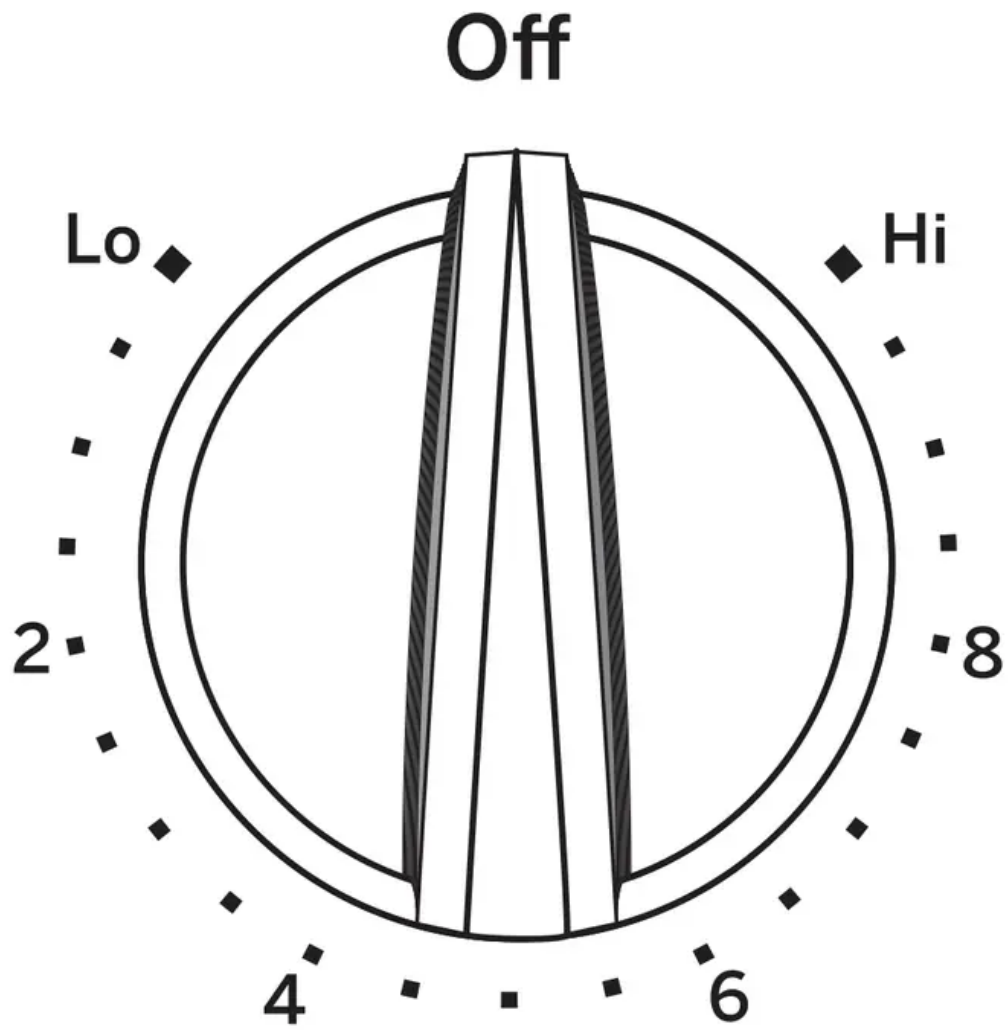

At both OFF and HI the control clicks into position. You may hear slight clicking sounds during cooking, indicating the control is maintaining your desired setting. Be sure you turn the control knob to OFF when you finish cooking.

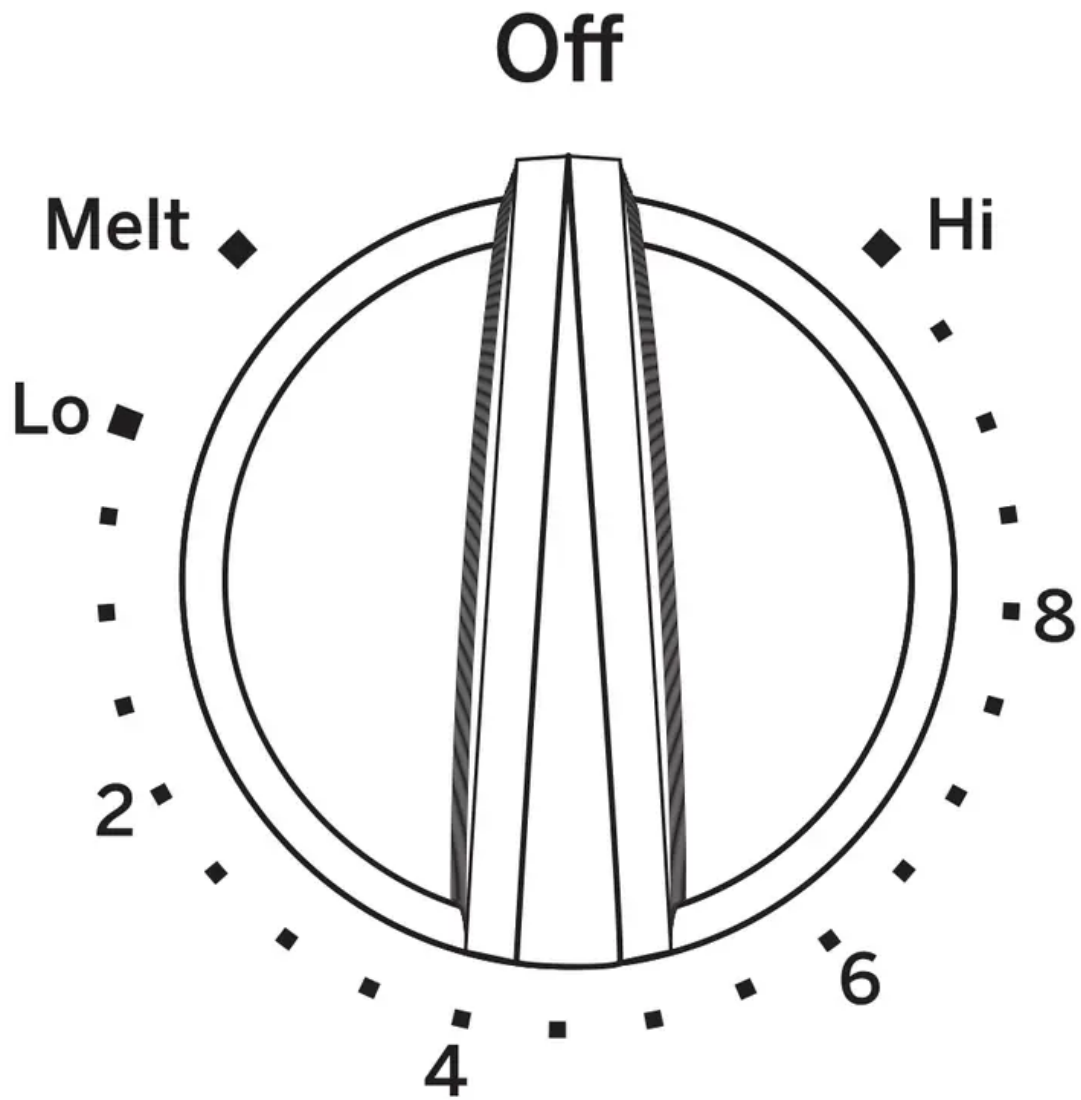

Melt setting (on some models) will melt chocolate or butter.

Dual Surface Units and Control Knobs (on some models)

The surface unit has 2 cooking sizes to select from so you can match the size of the unit to the size of the cookware you are using.



Small Burner ● Off ● Large Burner

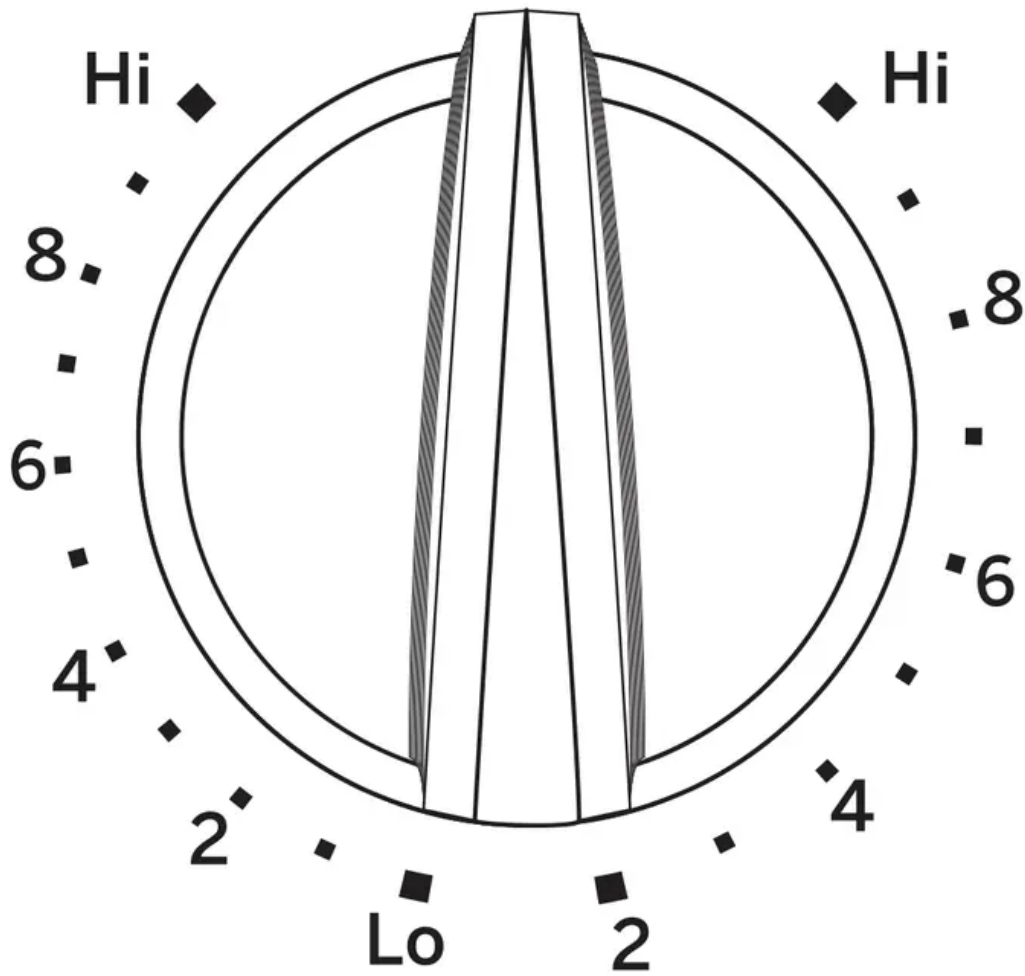

Models with a Dual-Ring surface element only



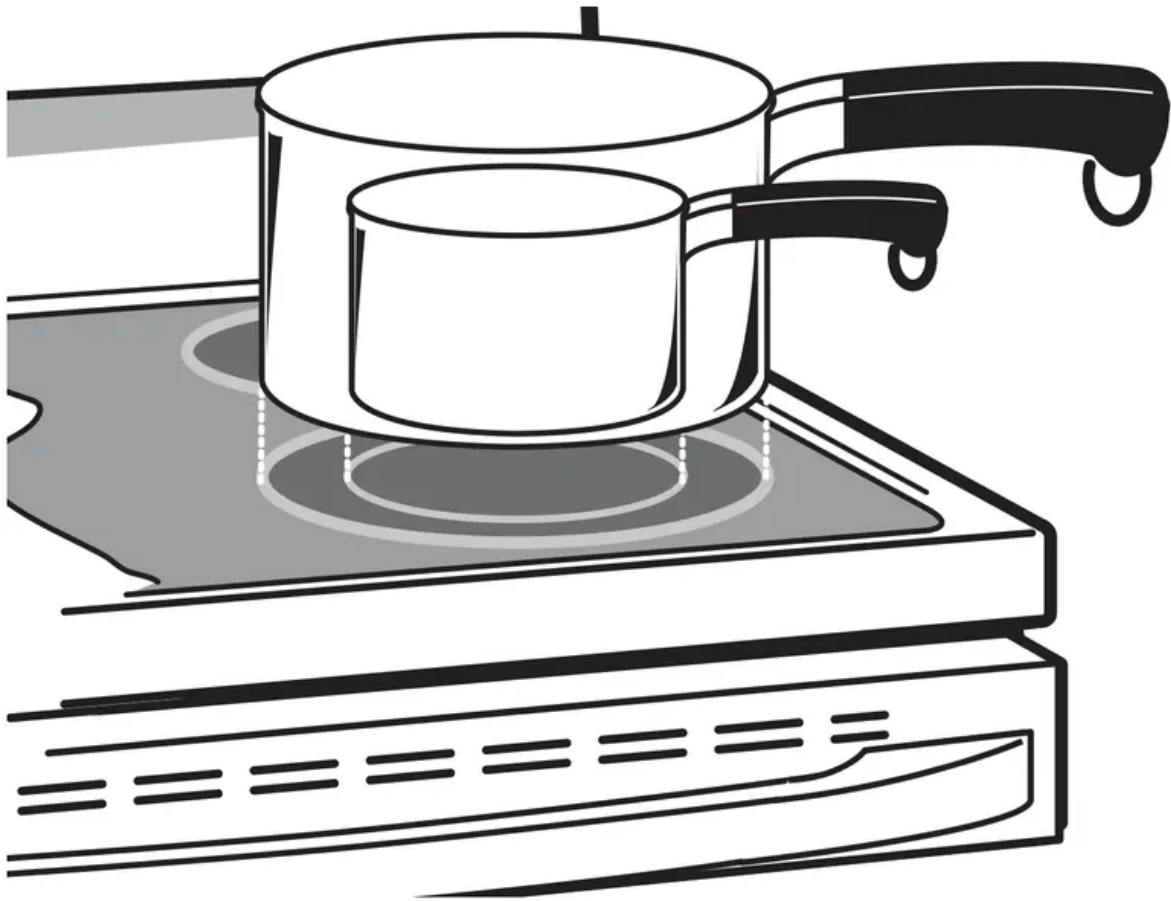

Using the Warming Zone

WARNING

FOOD POISON HAZARD: Bacteria may grow in food at temperatures below 140°F.

- Always start with hot food. Do not use warm setting to heat cold food.
- Do not use warm setting for more than 2 hours.

The WARMING ZONE, located in the back center of the glass surface, will keep hot, cooked food at serving temperature. Always start with hot food. Do not use to heat cold food. Placing uncooked or cold food on the WARMING ZONE could result in foodborne illness.

Turn the control knob to the ON position.

For best results, all foods on the WARMING ZONE should be covered with a lid or aluminum foil. When warming pastries or breads, the cover should be vented to allow moisture to escape.

The initial temperature, type and amount of food, type of pan, and the time held will affect the quality of the food.

Always use pot holders or oven mitts when removing food from the WARMING ZONE, since cookware and plates will be hot.

NOTE: The surface warmer will not glow red like the cooking elements.

Off

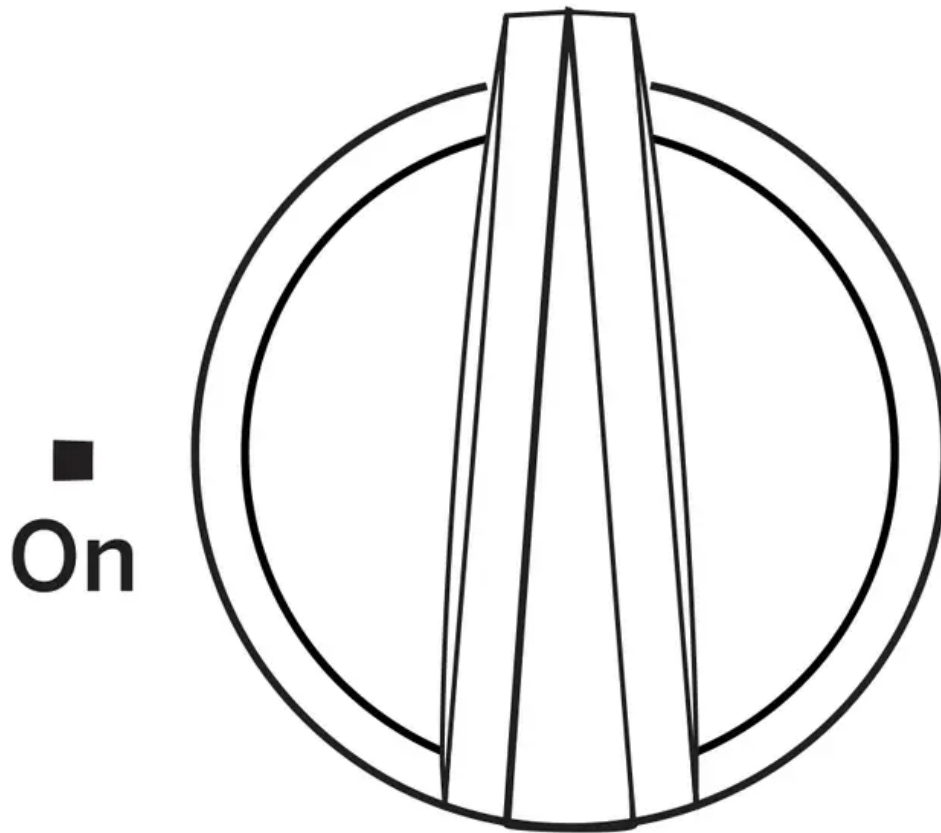

Warming Zone

Home Canning Tips

Be sure the canner is centered over the surface unit.

Make sure the canner is flat on the bottom.

To prevent burns from steam or heat, use caution when canning.

Use recipes and procedures from reputable sources. These are available from manufacturers such as Ball® and Kerr® and the Department of Agriculture Extension Service.

Flat-bottomed canners are recommended. Use of water bath canners with rippled bottoms may extend the time required to bring the water to a boil.

Radiant Glass Cooktop

The radiant cooktop features heating units beneath a smooth glass surface.

NOTE: A slight odor is normal when a new cooktop is used for the first time. It is caused by the heating of new parts and insulating materials and will disappear in a short time.

NOTE: On models with light-colored glass cooktops, it is normal for the cooking zones to change color when hot or cooling down. This is temporary and will disappear as the glass cools to room temperature.

The surface unit will cycle on and off to maintain your selected control setting.

It is safe to place hot cookware on the glass surface even when the cooktop is cool.

Even after the surface units are turned off, the glass cooktop retains enough heat to continue cooking. To avoid overcooking, remove pans from the surface units when the food is cooked. Avoid placing anything on the surface unit until it has cooled completely.

- Water stains (mineral deposits) are removable using the cleaning cream or full-strength white vinegar.
- Use of window cleaner may leave an iridescent film on the cooktop. The cleaning cream will remove this film.
- Don't store heavy items above the cooktop. If they drop onto the cooktop, they can cause damage.
- Do not use the surface as a cutting board.



Never cook directly on the glass. Always use cookware.



Always place the pan in the center of the surface unit you are cooking on.



Do not slide cookware across the cooktop because it can scratch the glass - the glass is scratch-resistant, not scratch proof.

Temperature Limiter on Radiant Glass Cooktops

Every radiant surface unit has a temperature limiter.

The temperature limiter protects the glass cooktop from getting too hot.

The temperature limiter may cycle the surface units off for a time if:

- the pan boils dry
- the pan bottom is not flat.
- the pan is off-center.
- there is no pan on the unit.

Cookware for Radiant Glass Cooktop

The following information will help you choose cookware which will give good performance on glass cooktops.

NOTE: Follow all cookware manufacturer's recommendations when using any type of cookware on the ceramic cooktop.

Recommended

Stainless Steel

Aluminum: heavy weight recommended

Good conductivity. Aluminum residues sometimes appear as scratches on the cooktop but can be removed if cleaned immediately. Because of its low melting point, thin weight aluminum should not be used.

Copper Bottom:

Copper may leave residues which can appear as scratches. The residues can be removed, as long as the cooktop is cleaned immediately. However, do not let these pots boil dry. Overheated metal can bond to glass cooktops. An overheated copper bottom pot will leave a residue that will permanently stain the cooktop if not removed immediately.

Enamel (painted) on Cast Iron:

recommended if bottom of pan is coated

Avoid/Not Recommended

Enamel (painted) on Steel:

Heating empty pans can cause permanent damage to cooktop glass. The enamel can melt and bond to the ceramic cooktop.

Glass-ceramic:

Poor performance. Will scratch the surface.

Stoneware:

Poor performance. May scratch the surface.

Cast Iron:

not recommended - unless designed specifically for glass cooktops Poor conductivity and slow to absorb heat. Will scratch the cooktop surface.

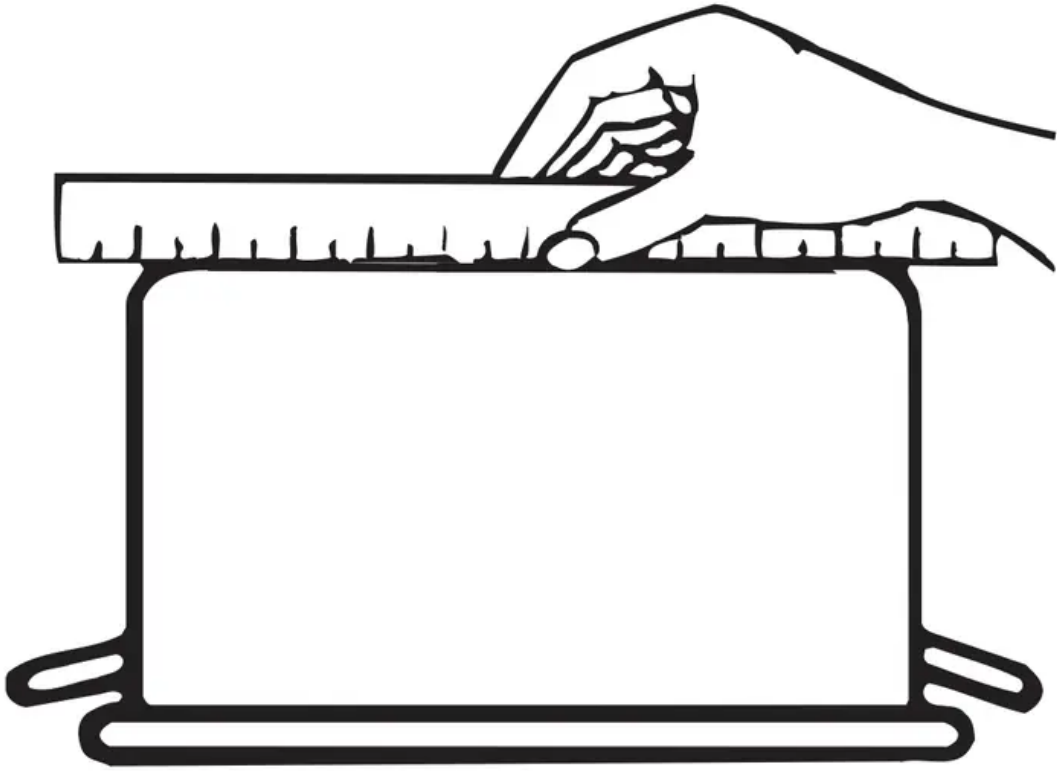

Check pans for flat bottoms by using a straight edge.

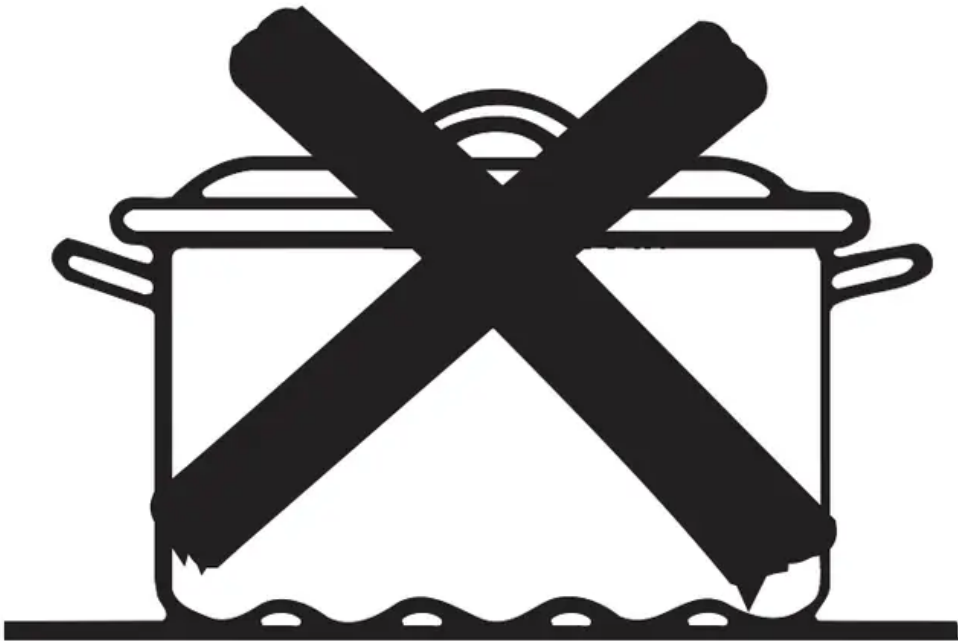
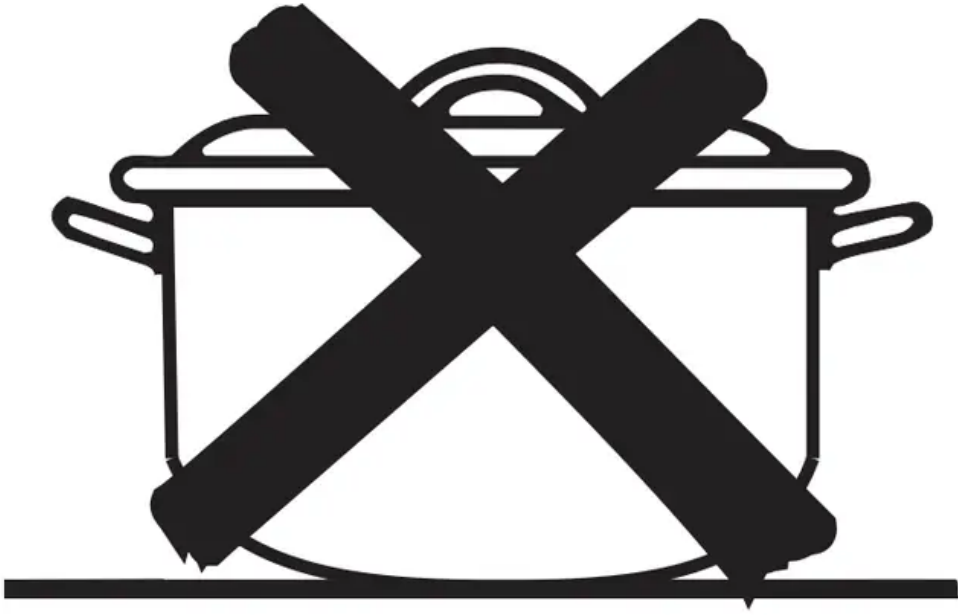

Pans with rounded, curved, ridged or warped bottoms are not recommended.

For Best Results

- Place only dry pans on the surface elements. Do not place lids on the surface elements, particularly wet lids. Wet pans and lids may stick to the surface when cool.
- Do not use woks that have support rings. This type of wok will not heat on glass surface elements.
- We recommend that you use only a flat-bottomed wok. They are available at your local retail store. The bottom of the wok should have the same diameter as the surface element to ensure proper contact.
- Some special cooking procedures require specific cookware such as pressure cookers or deep-fat fryers. All cookware must have flat bottoms and be the correct size.



Do not place wet pans on the glass cooktop.

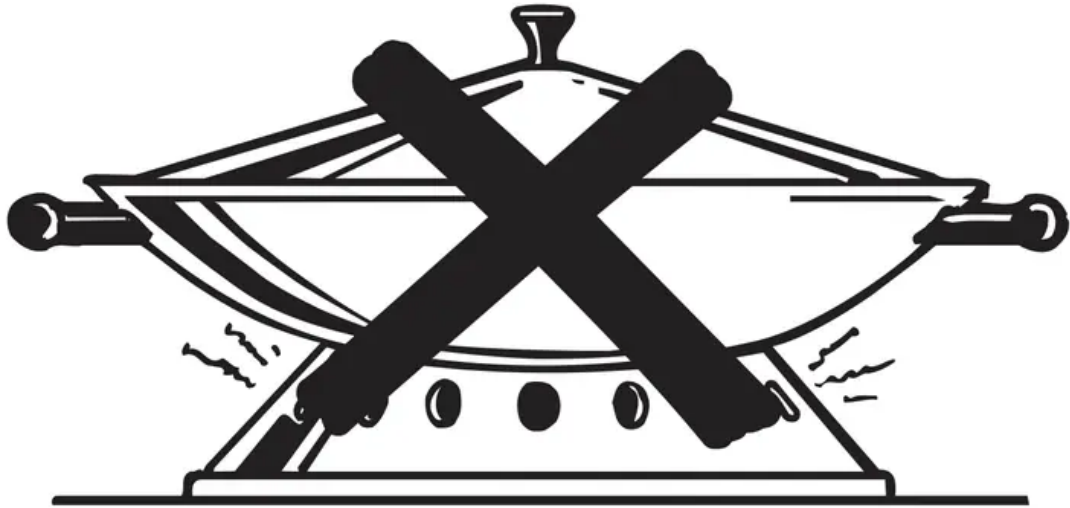

Do not use woks with support rings on the glass cooktop.



Use flat-bottomed woks on the glass cooktop.

Oven Controls

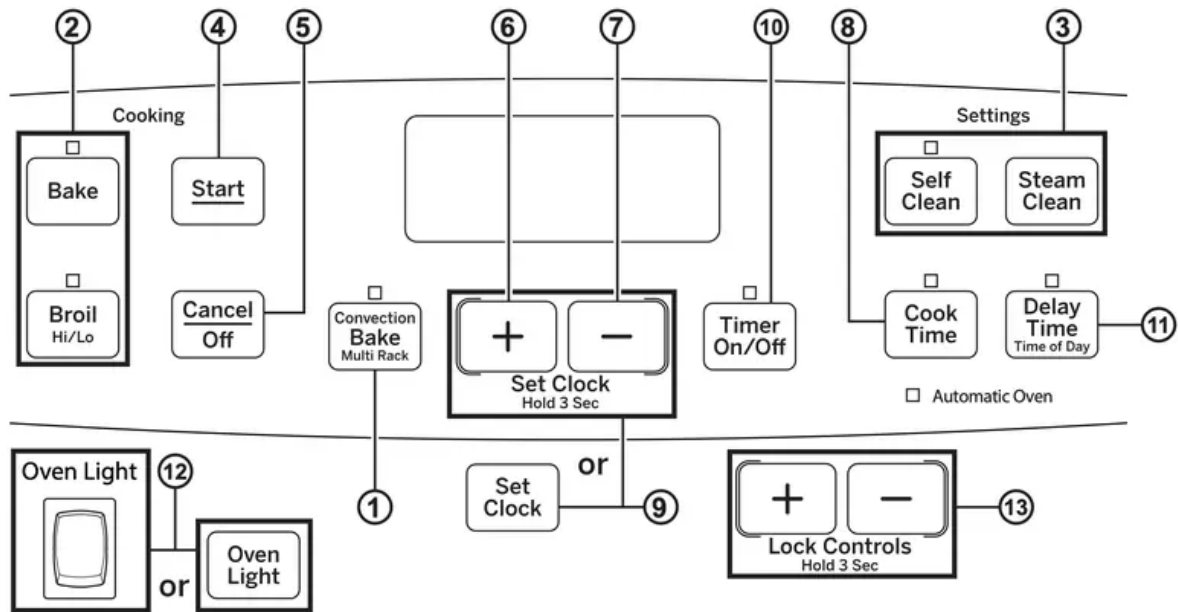

1. Convection Cooking (on some models):

Convection cooking modes use increased air circulation to improve performance. See the Cooking Modes section for more information.

2. Traditional Cooking Modes:

Your oven has the following traditional cooking modes: Bake and Broil Hi/Lo. See the Cooking Modes section for more information.

3. Clean (on some models):

Your oven may have up to two cleaning modes: Self Clean and Steam Clean. See the Cleaning the Oven section for important information about using these modes.

4. Start:

Must be pressed to start any cooking, cleaning, or timed function.

5. Cancel/Off:

Cancels ALL oven operations except the clock and timer.

6. + Pad:

Short taps to this pad will increase the time or temperature by small amounts. Touch and hold the pad to increase the time or temperature by larger amounts.

7. - Pad:

Short taps to this pad will decrease the time or temperature by small amounts. Touch and hold the pad to decrease the time or temperature by larger amounts.

8. Cook Time:

Counts down cooking time and turns off the oven when the cooking time is complete. Press the Cook Time pad, use the +/- pads to program a cooking time in hours and

minutes, then press Start. This can only be used with Bake and Convection Bake (where available).

9. Clock:

Sets the oven clock time. Press the Set Clock pad twice or press and hold the + - pads for 3 seconds and the +/- pads to program the clock.

Press Start to save the time.

10. Timer:

Works as a countdown timer. Press the Timer pad and the +/- pads to program the time in hours and minutes. Press the Start pad. The timer countdown is complete. To turn the timer off press the Timer pad.

11. Delay Time:

Delays when the oven will turn on. Use this to set a time when you want the oven to start. Press the Delay Time pad and use the +/- pads to program the time of day for the oven to turn on then press Start. Press the desired cooking mode and temperature then press Start. A Cook Time may also be programmed if desired. Follow the directions under Cook Time for setting this feature. This can only be used with Bake, Convection Bake and Self-Clean.

NOTE: When using the Delay Time feature, foods that spoil easily - such as milk, eggs, fish, stuffings, poultry and pork - should not be allowed to sit for more than 1 hour before or after cooking. Room temperature promotes the growth of harmful bacteria. Be sure that the oven light is off because heat from the bulb will speed harmful bacteria growth.

12. Oven Light:

Turns the oven light on or off.

13. Lock Controls (on some models):

Locks out the control so that pressing the pads does not activate the controls. Press and hold the +/- pads or the Lock Controls pad, for three seconds to lock or unlock the control. Cancel/Off is always active, even when the control is locked.

Special Features

There are several different special features on your range. To change the settings of these special features:

- Press the Bake and Broil pads at the same time and hold for three seconds.
- "SF" will appear in the display.
- Select the feature you want to change.
- When the change has been made, press the Start key to save the change and return to the time of day.

Adjust the Oven Temperature

This feature allows the oven baking and convection baking temperature to be adjusted up to 35°F hotter or down to 35°F cooler. Use this feature if you believe your oven temperature is too hot or too cold and wish to change it. This adjustment affects Bake and Convection Bake modes. No other cooking modes are affected.

Press the Bake pad to enter the temperature adjustment mode. A number between 35 and -35 will display. Use the +/- pads to set the desired temperature adjustment and use the Bake pad to change between negative and positive. Press the Start pad to save the temperature adjustment.

Clock Display

This feature can turn off the time of day display. Press the Timer On/Off pad to display the time of day (on) or turn off the time of day display (oFF).

NOTE: For models with a clock pad, the time of day display cannot be turned off in special features. Exit special features. To turn the time of day display off on these models, just press the clock pad once and then the start pad. To have the display turned back on, press the clock pad again and then the start pad.

12-hour auto shut-off and Sabbath

Options for this feature are "12SHdn", "no SHdn" and "SAb".

12-hour auto shut-off turns off the oven after 12 hours of continuous operations.

Sabbath mode disables all sounds (the control will not beep when a button is pressed), Convection, Broil, CookTime, Timer, Clock, and Delay Time functions. Sabbath mode can only be used with Bake. This feature conforms to the Star-K Jewish Sabbath requirements.

NOTE: The oven light comes on automatically (on some models) when the door is opened and goes off when the door is closed. The bulb may be removed. See the Oven Light Replacement section. On models with a light switch on the control panel, the oven light may be turned on and left on.

Press the Set Clock pad to view the current setting and then to change the setting.

For models that do not have a Set Clock pad, press the Cook Time pad to view the current setting and then to change the setting.

To use Sabbath mode, select "SAb" and press Start. A] will appear in the display and the clock will not display.

Once in Sabbath mode, at any time you can press Bake to start the oven. Note that when programming a bake in Sabbath mode, the preset starting temperature will automatically be set to 350°F. Press the + or - pads to increase or decrease the temperature in 25°F increments for temperatures between 170°F and 550°F and then press Start.

No sound will be given when the keys are pressed. At a random time between 30 seconds and 1 minute,][, will appear in the display indicating the oven is running.

If you need to adjust the temperature while baking, press Bake again. Press the + or - pads to increase or decrease the temperature in 25°F from the previous temperature you set to the new baking temperature and then press Start.

To exit Sabbath mode, make sure that the oven is turned off. To turn the oven off, press Cancel/Off. The oven will immediately turn off and][will change to] indicating that the oven has turned off. Press and hold the Bake and Broil pads for 3 seconds to enter special features then press Delay Time until either "12 Shdn" or "no Shdn" is in the display and press Start.

NOTE: If power outage occurs, the Sabbath mode will not resume when power is restored.

If you wish to use the Cook Time feature (if available) to bake in the oven and then have the oven automatically turn off, you will need to press the Cook Time pad, enter a cooking time duration, and press Start. Then enter special features to start Sabbath mode as detailed above.

Oven Racks

Recommended rack positions for various types of foods are provided in the Cooking Guide. Adjusting rack position is one way to impact cooking results. For example, if you would prefer darker tops on cakes, muffins, or cookies, try moving food one rack position higher. If you find foods are too brown on top try moving them down next time.

When baking with multiple pans and on multiple racks, ensure there is at least 1½" between pans to allow sufficient space for air to flow.

To avoid possible burns, place the racks in the desired position before you turn the oven on.

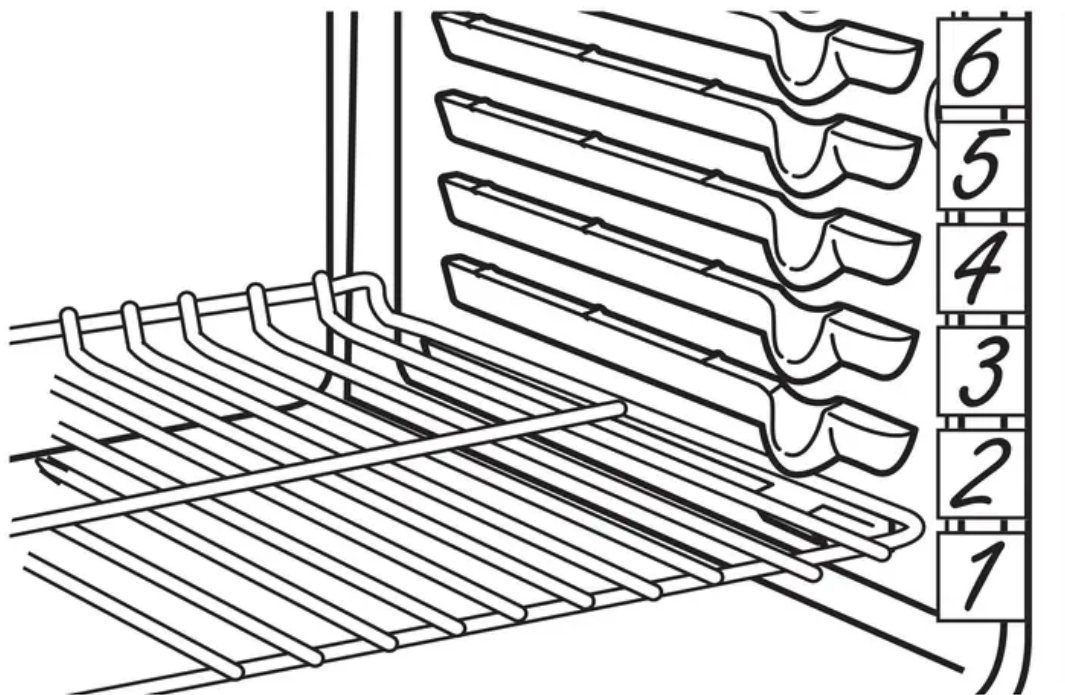

The number of rack positions may vary by model.

Aluminum Foil and Oven Liners

CAUTION: Do not use any type of foil or oven liner to cover the oven bottom. These items can trap heat or melt, resulting in damage to the product and risk of shock, smoke or fire. Damage from improper use of these items is not covered by the product warranty.

Foil may be used to catch spills by placing a sheet on a lower rack, several inches below the food. Do not use more foil than necessary and never entirely cover an oven rack with aluminum foil. Keep foil at least 1-1/2" from oven walls to prevent poor heat circulation.

Cookware

Cookware Guidelines

The material, finish, and size of cookware affect baking performance.

Dark, coated and dull pans absorb heat more readily than light, shiny pans. Pans that absorb heat more readily can result in a browner, crisper, and thicker crust. If using dark and coated cookware check food earlier than minimum cook time. If undesirable results are obtained with this type of cookware consider reducing oven temperature by 25°F next time.

Shiny pans can produce more evenly cooked baked goods such as cakes and cookies.

Glass and ceramic pans heat slowly but retain heat well. These types of pans work well for dishes such as pies and custards.

Air insulated pans heat slowly and can reduce bottom browning.

Keep cookware clean to promote even heating.

Cooking Modes

Your new oven has a variety of cooking modes to help you get the best results. These modes are described below. Refer to the Cooking Guide section for recommendations for specific foods. Remember, your new oven may perform differently than the oven it is replacing.

Baking Modes

Select a mode for baking based on the type and quantity of food you are preparing. When preparing baked goods such as cakes, cookies, and pastries always preheat the oven first. Follow recipe recommendations for food placement. If no guidelines are provided, center food in the oven.

Bake

The bake mode is intended for single rack cooking. This mode uses heat primarily from the lower element but also from the upper element to cook food. To use this mode press the Bake pad, use the +/- pads to set the desired temperature, and then press Start. Preheating is generally recommended when using this mode.

Convection Bake

The Convection Bake mode is intended for baking on multiple racks at the same time. This mode uses heat from the upper and lower elements, along with air movement from the convection fan to enhance cooking evenness. Baking time might be slightly longer for multiple racks than what would be expected for a single rack. To use this mode press the Convection Bake pad, enter a temperature, and then press Start. Always preheat when using this mode. When baking more delicate foods like cookies and cakes, it is recommended to reduce the input temperature by 25°F for improved cooking performance.

Broiling Modes

Monitor food closely while broiling. Use caution when broiling on upper rack positions as placing food closer to the broil element increases smoking, spattering, and the possibility of fats igniting. For best performance center food below the broil heating element.

Try broiling foods that you would normally grill. Adjust rack positions to adjust the intensity of the heat to the food. Place foods closer to the broil element when a seared surface and rare interior is desired. Thicker foods and foods that need to be cooked through should be broiled on a rack position farther from the broiler or by using Broil Lo.

Broil Hi

The Broil Hi mode uses intense heat from the upper element to sear foods. It is recommended that Broil Hi be done with the door open for improved searing. Use Broil Hi for thinner cuts of meat and/or foods you prefer less done on the interior. To use this mode press the Broil pad once and then press Start. It is not necessary to reheat when using this mode.

Broil Lo

The Broil Lo mode uses less intense heat from the upper element to cook food thoroughly while also producing surface browning. The door may be closed or open when using Broil Lo. Use Broil Lo for thicker cuts of meat and/or foods that you would like cooked all the way through. To use this mode press the Broil pad twice and then press Start. It is not necessary to preheat when using this mode.

Cooking Guide

| FOOD TYPE | RECOMMENDED MODE(S) | RECOMMENDED RACK POSITION(S) | ADDITIONAL SUGGESTIONS |
|--|--|--|--|
| Baked Goods | | | |
| Layer Cakes, sheet cakes, bundt cakes, muffins, quick breads on a Single Rack | Bake | 4 | Use shiny cookware. |
| Layer cakes* on Multiple Racks | Bake | 3 and 5 | Ensure adequate airflow (see illustration below). |
| Chiffon cakes (angel food) | Bake | 1 | Use shiny cookware. |
| Cookies, biscuits, scones on a Single Rack | Bake | 4 | Use shiny cookware. |
| Cookies, biscuits, scones on Multiple Racks | Bake Convection Bake (if available) | 3 and 5 | Ensure adequate airflow. Reduce input temperature by 25°F when using Convection Bake only. |
| Beef & Pork | | | |
| Hamburgers | Broil Hi | 6 | Use a broil pan; move food down for more doneness/less searing. Watch food closely when broiling. For best performance center food below the broil heating element |
| Steaks & Chops | Broil Hi | 6 | Use a broil pan; move food down for more doneness/less searing. Watch food closely when broiling. For best performance center food below the broil heating element |
| Roasts | Bake | 3 or 4 | Use a low sided pan such as a broil pan. Preheating is not necessary |
| Poultry | | | |
| Whole chicken | Bake | 3 or 4 | Use a low sided pan such as a broil pan. |
| Bone-in chicken breasts, legs, thighs | Broil Hi | 3 | If breaded or coated in sauce avoid Broil Hi modes. Broil skin side down first. Watch food closely when broiling. For best performance when broiling, center food below the broil heating element. |
| | Broil Lo Bake | 3 or 4 | |
| Boneless chicken breasts | Broil Lo Bake | 3 or 4 | If breaded or coated in sauce avoid Broil Hi modes. Broil skin side down first. Watch food closely when broiling. For best performance when broiling, center food below the broil heating element |
| Whole turkey | Bake | 2 or 3 | Use a low sided pan such as a broil pan. |
| Turkey Breast | Bake | 2 or 3 | Use a low sided pan such as a broil pan. |
| Fish | Broil Lo | 6 (1/2 thick or less) 5 (>1/2 inch) | Watch food closely when broiling. For best performance center food below the broil heating element. |
| Casseroles | Bake | 4 | |
| Frozen Convenience Foods | | | |
| Pizza, french fries, tator tots, chicken nuggets, appetizers on a Single Rack | Bake | 4 | Use shiny cookware. |
| Pizza, french fries, tator tots, chicken nuggets, appetizers on Multiple Racks | Bake Convection Bake (if available) | 3 and 5 | Use shiny cookware. Reducing input temperature is not recommended when using Convection Bake. |

*When baking four cake layers at a time, use racks 3 and 5. Place the pans as shown so that one pan is not directly above another.

Cook food thoroughly to help protect against food borne illness. Minimum safe food temperature recommendations for food safety. Make sure to use a food thermometer to take food temperatures.

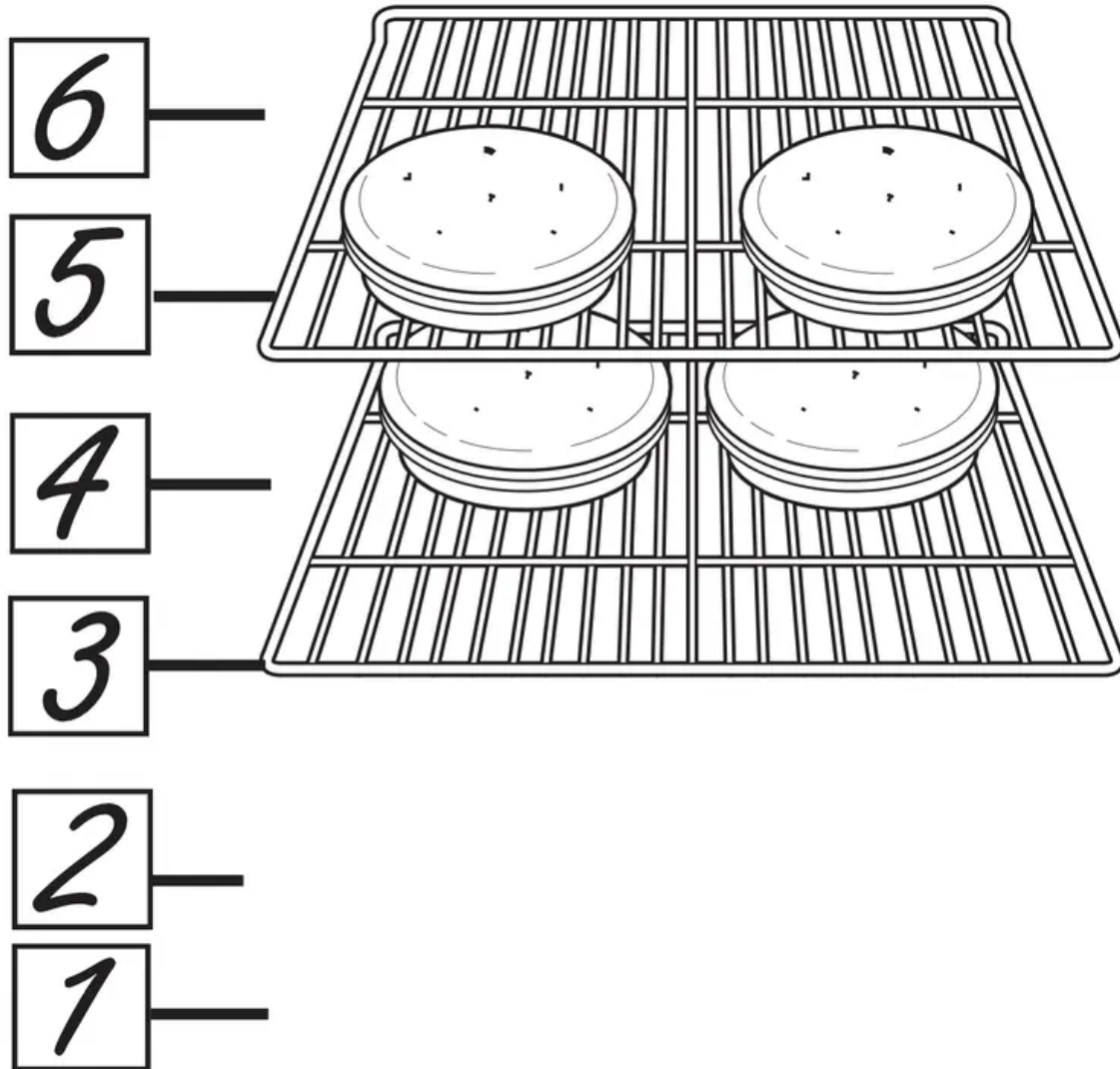

Rack position for baking 4 layer cakes.

CARE AND CLEANING

Cleaning the Range – Exterior

Be sure all controls are off and all surfaces are cool before cleaning any part of the range.

WARNING: If your range is removed for cleaning, servicing or any reason, be sure the anti-tip device is reengaged properly when the range is replaced. Failure to take this precaution could result in tipping of the range and can result in death or serious burns to children or adults.

Control Knobs

The control knobs may be removed for easier cleaning. Make sure the knobs are in the OFF positions and pull them straight off the stems for cleaning.

The knobs can be cleaned in a dishwasher or they may also be washed with soap and water. Make sure the inside of the knobs are dry before replacing.

Control Lockout (on some models)

If desired, the touch pads may be deactivated before cleaning.

See Lock Controls in the Oven Controls section in this manual.

Clean up splatters with a damp cloth.

You may also use a glass cleaner.

Remove heavier soil with warm, soapy water. Do not use abrasives of any kind.

Reactivate the touch pads after cleaning.

Control Panel

It's a good idea to wipe the control panel after each use. Clean with mild soap and water or vinegar and water, rinse with clean water and polish dry with a soft cloth.

Do not use abrasive cleansers, strong liquid cleansers, plastic scouring pads or oven cleaners on the control panel—they will damage the finish.

Oven Exterior

Do not use oven cleaners, abrasive cleaners, strong liquid cleansers, steel wool, plastic scouring pads, or cleaning powders on the interior or exterior of the oven. Clean with a mild soap and water or vinegar and water solution. Rinse with clean water and dry with a soft cloth. When cleaning surfaces, make sure that they are at room temperature and not in direct sunlight.

If stain on the door vent trim is persistent, use a mild abrasive cleaner and a sponge-scrubber for best results.

Spillage of marinades, fruit juices, tomato sauces and basting liquids containing acids may cause discoloration and should be wiped up immediately. Let hot surfaces cool, then clean and rinse.

Painted Surfaces

Painted surfaces include the sides of the range and the door, top of control panel and the drawer front. Clean these with soap and water or a vinegar and water solution.

Do not use commercial oven cleaners, cleaning powders, steel wool or harsh abrasives on any painted surface.

Porcelain Enamel Cooktop

The porcelain enamel finish is sturdy but breakable if misused. This finish is acid-resistant. However, any acidic foods spilled (such as fruit juices, tomato or vinegar) should not be permitted to remain on the finish.

If acids spill on the cooktop while it is hot, use a dry paper towel or cloth to wipe it up right away. When the surface has cooled, wash with soap and water. Rinse well.

For other spills such as fat splatterings, wash with soap and water or cleansing powders after the surface has cooled. Rinse well. Polish with a dry cloth.

Fingerprint Resistant Stainless Steel* (Black Stainless, Slate, Dark Slate, and Painted)

WARNING: DO NOT use Stainless Steel cleaners on outside surfaces.

IMPORTANT: The use of incorrect products may damage the outer finish of Fingerprint Resistant Stainless and Black Stainless models. Please follow these instructions and use only the appropriate items below to clean your appliance surfaces.

- Clean interior/exterior surfaces with warm water, mild soap or detergent, and a soft or microfiber cloth to avoid damage.
- Wipe the appliance surface dry with a soft clean cloth or microfiber towel to avoid streaking or water spotting.

| DO USE | DO NOT USE |
|--|---|
| <ul style="list-style-type: none">• Soft, clean cloth or sponge Microfiber cloth | <ul style="list-style-type: none">• Abrasive cloths, paper towels, scrubbing sponges (with or without soap), scouring or steel wool pads |
| <ul style="list-style-type: none">• Mild detergent mixed with warm water | <ul style="list-style-type: none">• Abrasive powders, liquids, or sprays• Window sprays, ammonia, or bleach• Citrus or plant oil-based cleaners• Acidic or vinegar-based cleaners• Oven cleaners• Alkaline cleaners• Stainless steel cleaners |

*Easily wipe away smudges and fingerprints.

Stainless Steel Surfaces (on some models)

Do not use a steel wool pad; it will scratch the surface.

To clean the stainless steel surface, use warm sudsy water or a stainless steel cleaner or polish. Always wipe the surface in the direction of the grain. Follow the cleaner instructions for cleaning the stainless steel surface.

To inquire about purchasing cleaning products including stainless steel appliance cleaner or polish, see the Accessories and Consumer Support sections at the end of this manual.

NOTE: DO NOT allow stainless steel cleaner to come in contact with any plastic parts such as control knobs. If unintentional contact of cleaners with plastic parts does occur, clean plastic part with a sponge and mild detergent mixed with warm water.

| DO USE | DO NOT USE |
|---|--|
| <ul style="list-style-type: none"> • Soft, clean cloth or sponge | <ul style="list-style-type: none"> • Abrasive cloths, scrubbing sponges (with or without soap), scouring or steel wool pads |
| <ul style="list-style-type: none"> • Mild detergent mixed with warm water • Approved stainless steel cleaners; Visit the GE Appliances parts store for approved stainless steel cleaners • Cleaners with oxalic acid such as Bar Keepers Friend Soft Cleanser™ can be used to remove surface rust, tarnish and small blemishes on stainless steel surfaces only. | <ul style="list-style-type: none"> • Abrasive powders or sprays • Window Sprays or Ammonia • Citrus or plant oil-based cleaners • Acidic or vinegar-based cleaners • Oven cleaners • Cleaners containing acetone (propanone) • Any cleaner with WARNING about plastic contact |

Cleaning the Range – Interior

The interior of your new oven can be cleaned manually or by using Steam Clean or Self Clean modes.

Spillage of marinades, fruit juices, tomato sauces and basting liquids containing acids may cause discoloration and should be wiped up immediately. Let hot surfaces cool, then clean and rinse.

Manual Cleaning

Do not use oven cleaners, abrasive cleaners, strong liquid cleansers, steel wool, scouring pads, or cleaning powders on the interior of the oven. Clean with a mild soap and water or vinegar and water solution. Rinse with clean water and dry with a soft cloth. When cleaning surfaces, make sure that they are at room temperature.

Porcelain Oven Interior (on models that do not have a self-clean feature)

With proper care, the porcelain enamel finish on the inside of the oven-top, bottom, sides, back and inside of the door-will stay new-looking for years.

Let the oven cool before cleaning. We recommend that you wear rubber gloves when cleaning the oven.

Soap and water will normally do the job. Heavy spattering or spillovers may require cleaning with a mild abrasive cleaner. Soap-filled scouring pads may also be used.

Do not allow food spills with a high sugar or acid content (such as tomatoes, sauerkraut, fruit juices or pie filling) to remain on the surface. They may cause a dull spot even after cleaning.

Household ammonia may make the cleaning job easier. Place 1/2 cup in a shallow glass or pottery container in a cold oven overnight. The ammonia fumes will help loosen the burned-on grease and food.

If necessary, you may use an oven cleaner. Follow the package directions.

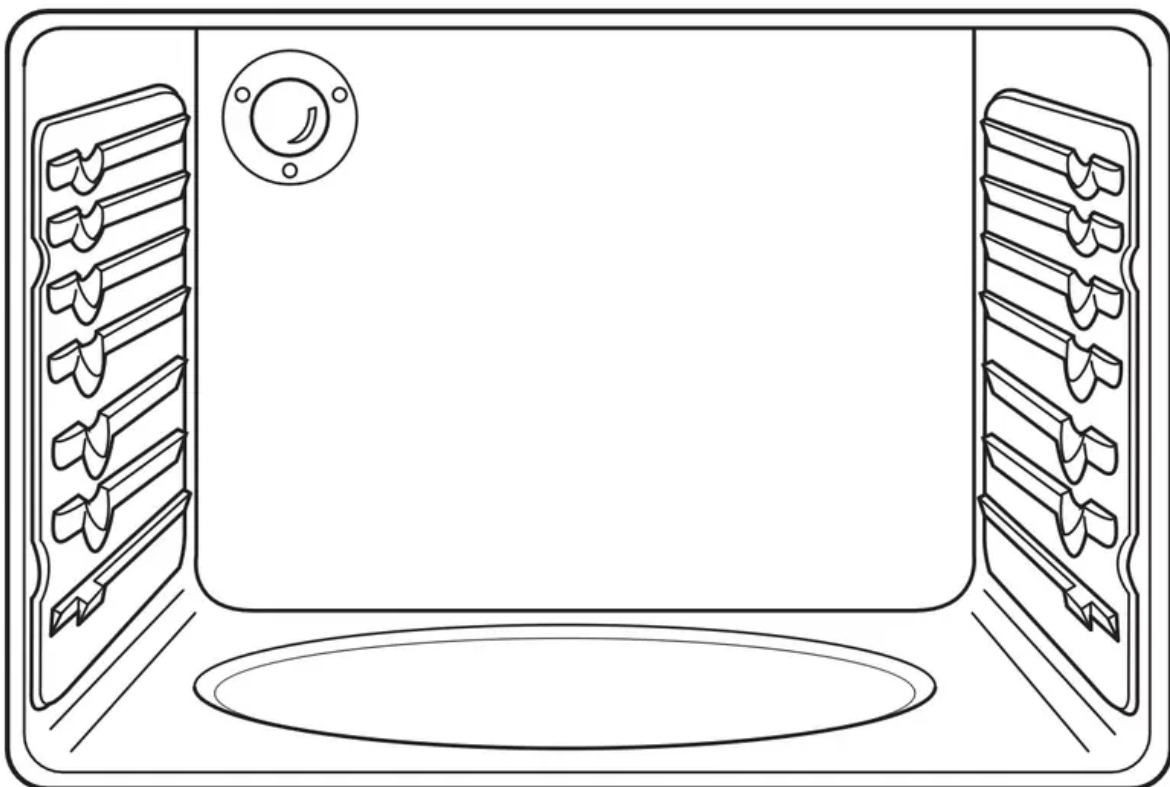

- Do not spray oven cleaner on the electrical controls and switches because it could cause a short circuit and result in sparking or fire.
- Do not allow a film from the cleaner to build up on the temperature sensor-it could cause the oven to heat improperly. (The sensor is located at the top of the oven). Carefully wipe the sensor clean after each oven cleaning, being careful not to move the sensor as a change in its position could affect how the oven bakes.
- Do not spray any oven cleaner on the oven door, handles or any exterior surface of the oven, cabinets or painted surfaces. The cleaner can damage these surfaces.

Steam Clean Mode (on some models)

Steam clean is intended to clean small spills using water and a lower cleaning temperature than Self-Clean.

To use the Steam Clean feature, wipe grease and soils from the oven. Pour one cup of water into the bottom of the oven. Close the door. Press the Steam Clean pad and then press Start. Latch the door. You can not open the door during the 30 minute steam clean as this will decrease the steam clean performance. At the end of the steam clean cycle, wipe out any excess water and any remaining soil.

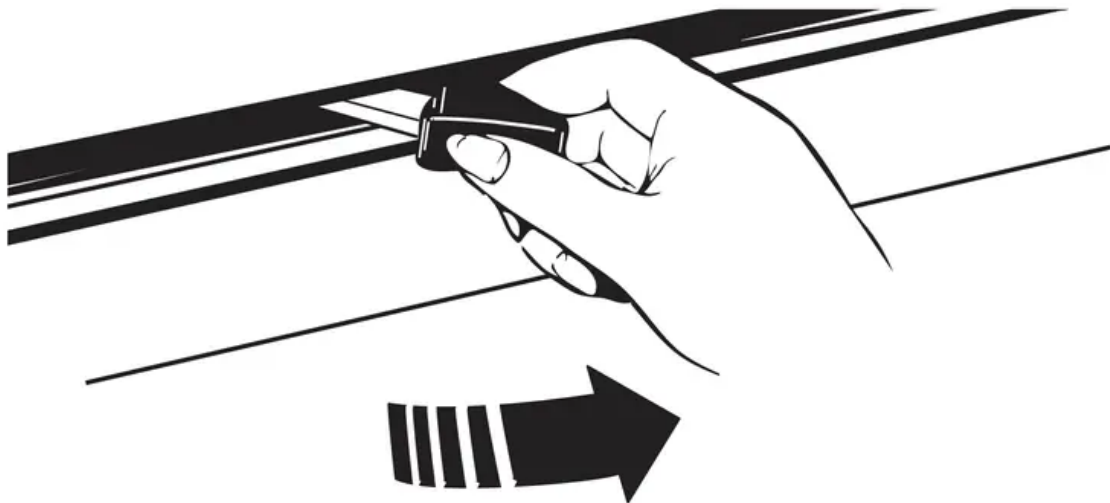

Self Clean Mode (on some models)

Read Self-Cleaning Oven Safety Instructions at the beginning of this manual before using Self Clean Mode. Self clean uses very high temperatures to clean the oven interior. You will need to lock the oven door when using this feature. Before operating the self-clean cycle, wipe up grease and soils from the oven. Remove all items from the oven other than enameled (dark color) racks. Shiny or silver racks and any cookware or other items should all be removed from the oven before initiating a self-clean cycle. Close the door. Latch the door.

NOTE: Never force the latch. If the oven is too hot, you will not be able to slide the latch. Allow the oven to cool.

Press the Self Clean pad and a default self-clean time is displayed. The clean time can be changed to any time between 3:00 and 5:00 hours by using the +/- pads to enter a different time and pressing Start. For heavily soiled ovens, the maximum 5 hour clean time is recommended. If you wish to use the default time, press the Start pad immediately after pressing the Self Clean pad. The oven will turn off automatically when the selfclean cycle is complete. After the oven has cooled down wipe any ash out of the oven.

We recommend venting your kitchen with an open window or using a ventilation fan or hood during the first self-clean cycle.

Soil on the front frame of the range and outside the gasket on the door will need to be cleaned by hand.

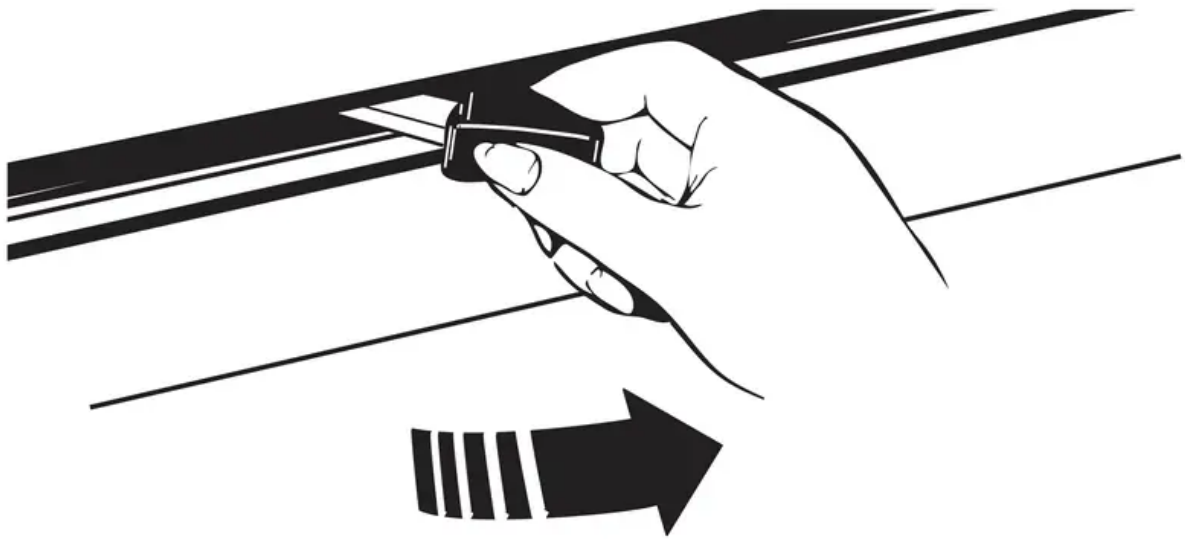

Clean these areas with hot water, soap-filled steel-wool pads or cleansers such as Soft Scrub® . Rinse well with clean water and dry.

Do not clean the gasket. The fiberglass material of the oven door gasket cannot withstand abrasion. It is essential for the gasket to remain intact. If you notice it becoming worn or frayed, replace it.

Make sure the oven light bulb cover is in place and the oven light is off.

IMPORTANT: The health of some birds is extremely sensitive to the fumes given off during the self-cleaning cycle of any range. Move birds to another wellventilated room.

To Stop a Self-Clean Cycle Press the Cancel/Off pad. Wait until the oven has cooled below the locking temperature to unlatch the door. You will not be able to open the door right away unless the oven has cooled below the locking temperature.

Racks

All racks can be washed with warm, soapy water. Enameled (not shiny) racks can be left in the cavity during self clean.

Racks may be more difficult to slide, especially after a self-clean. Put some vegetable oil on a soft cloth or paper towel and rub onto the left and right edges.

NOTE: Using other cooking oils will cause a discoloring or a rust like color residue on the racks and cavity sides. To clean this residue, use a soap and water or a vinegar and water solution. Rinse with clean water and dry with a soft cloth.

Oven Heating Elements

Do not clean the bake element or the broil element. Any soil will burn off when the elements are heated.

To clean the oven floor when the bake element is exposed, gently lift the bake element. On some models, the bake element is not exposed and is under the oven floor. Clean the oven floor with warm, soapy water.

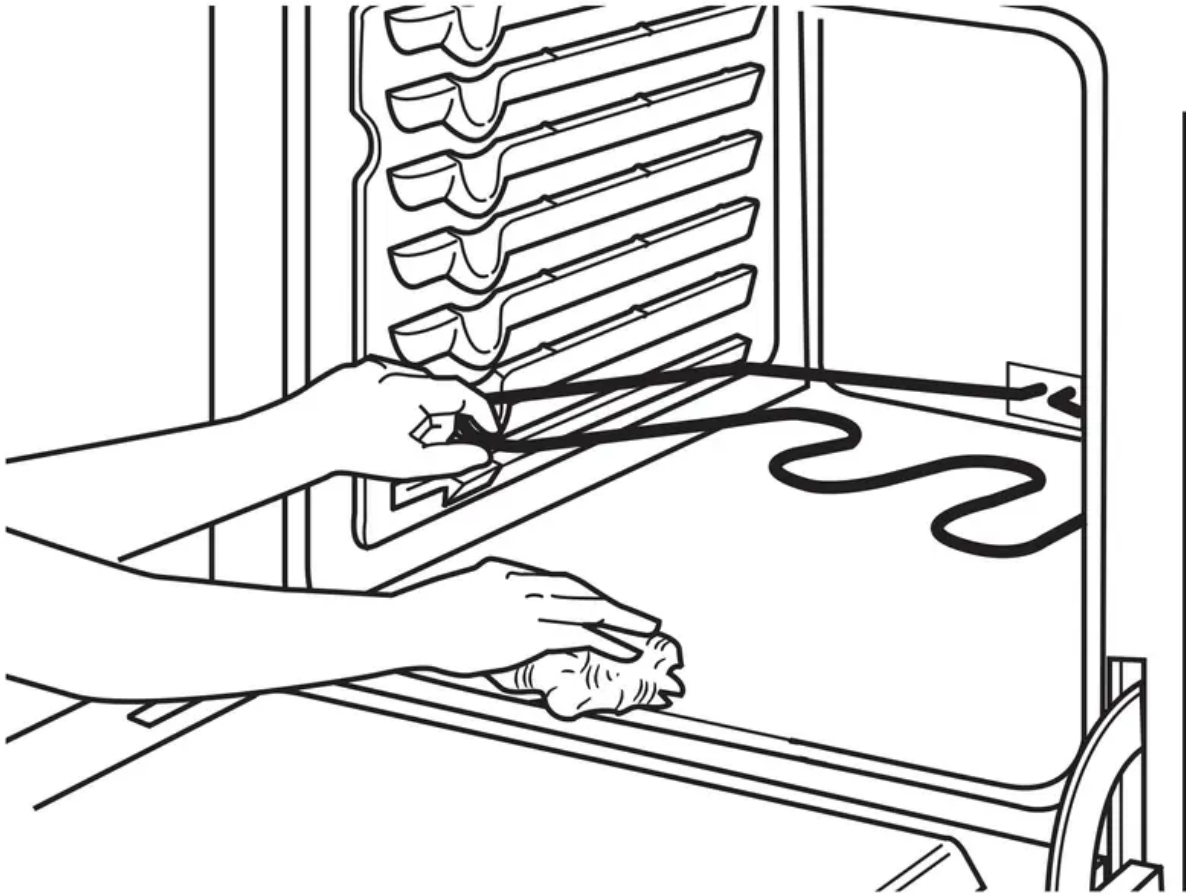

Gently lift the bake element

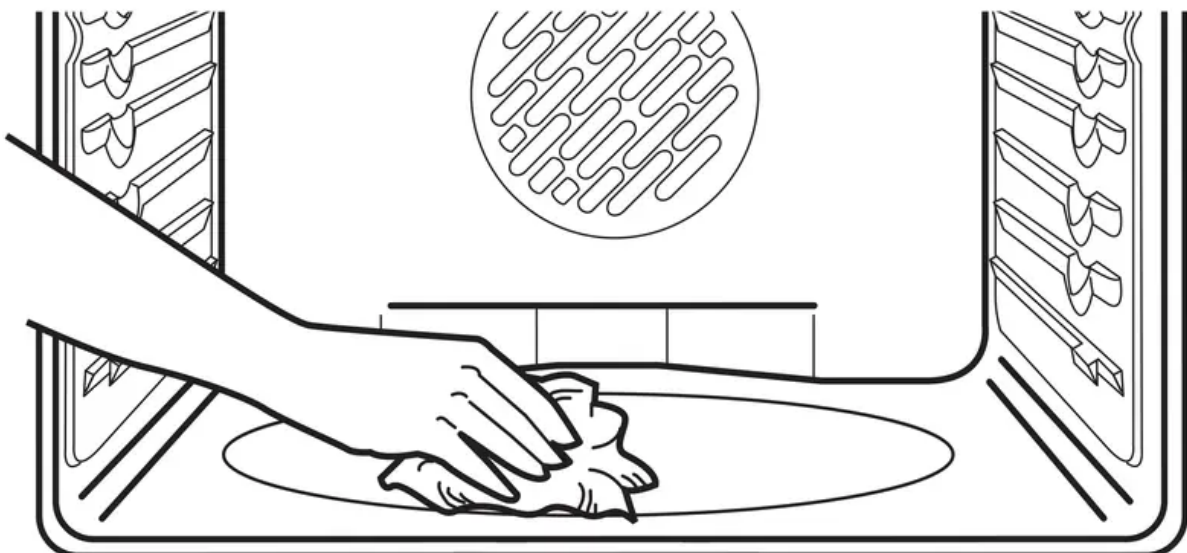

Wipe up heavy soil on the oven bottom.

Cleaning the Glass Cooktop

Normal Daily Use Cleaning

ONLY use CERAMA BRYTE® Ceramic Cooktop Cleaner on the glass cooktop. Other creams may not be as effective.

To maintain and protect the surface of your glass cooktop, follow these steps:

1. Before using the cooktop for the first time, clean it with CERAMA BRYTE® Ceramic Cooktop Cleaner. This helps protect the top and makes cleanup easier.
2. Daily use of CERAMA BRYTE® Ceramic Cooktop Cleaner will help keep the cooktop looking new.
3. Shake the cleaning cream well. Apply a few drops of CERAMA BRYTE® Ceramic Cooktop Cleaner directly to the cooktop.
4. Use a paper towel or CERAMA BRYTE® Cleaning Pad for Ceramic Cooktops to clean the entire cooktop surface.
5. Use a dry cloth or paper towel to remove all cleaning residue. No need to rinse.

NOTE: It is very important that you DO NOT heat the cooktop until it has been cleaned thoroughly.



Clean your cooktop after each spill. Use CERAMA BRYTE® Ceramic Cooktop Cleaner.

Burned-On Residue

NOTE: DAMAGE to your glass surface may occur if you use scrub pads other than those recommended.

1. Allow the cooktop to cool.
2. Spread a few drops of CERAMA BRYTE® Ceramic Cooktop Cleaner on the entire burned residue area.
3. Using a CERAMA BRYTE® Cleaning Pad for Ceramic Cooktops, rub the residue area, applying pressure as needed.
4. If any residue remains, repeat the steps listed above as needed.
5. For additional protection, after all residue has been removed, polish the entire surface with CERAMA BRYTE® Ceramic Cooktop Cleaner and a paper towel.

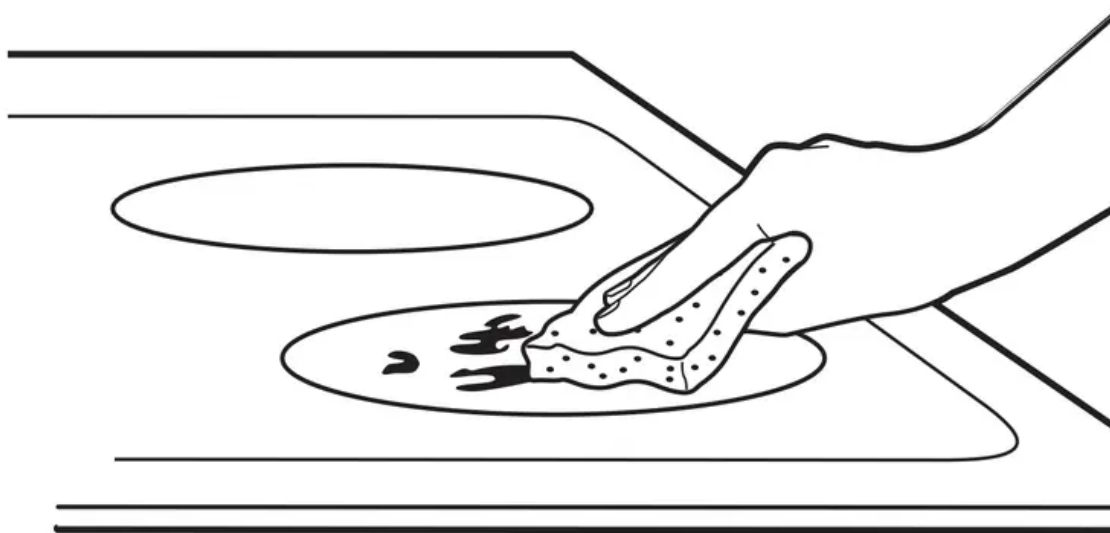

Using a CERAMA BRYTE® Cleaning Pad for Ceramic Cooktops.

Heavy, Burned-On Residue

1. Allow the cooktop to cool.
2. Use a single-edge razor blade scraper at approximately a 45° angle against the glass surface and scrape the soil. It will be necessary to apply pressure to the razor scraper in order to remove the residue.
3. After scraping with the razor scraper, spread a few drops of CERAMA BRYTE® Ceramic Cooktop Cleaner on the entire burned residue area. Use a CERAMA BRYTE® Cleaning Pad to remove any remaining residue.
4. For additional protection, after all residue has been removed, polish the entire surface with CERAMA BRYTE® Ceramic Cooktop Cleaner and a paper towel.

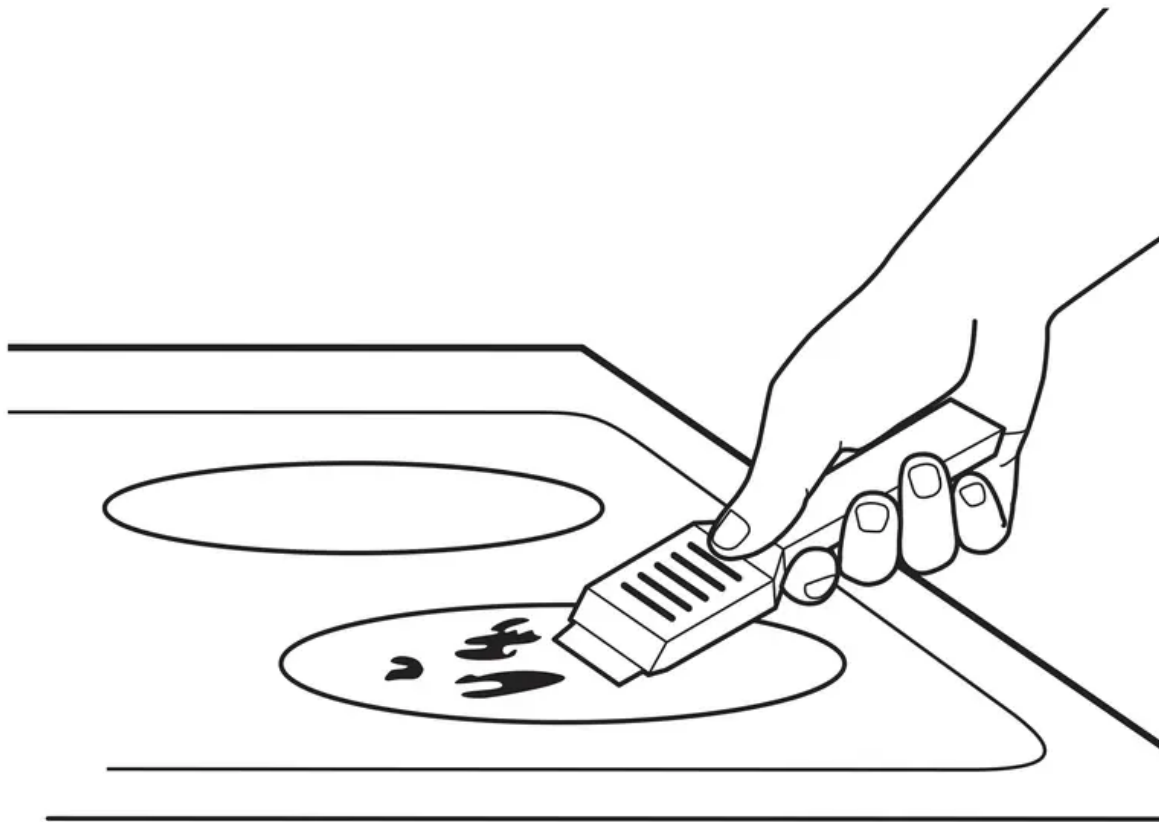

The CERAMA BRYTE® Ceramic Cooktop Scraper and all recommended supplies are available through our Parts Center. See the Accessories and Consumer Support sections at the end of this manual.

NOTE: Do not use a dull or nicked blade

Metal Marks and Scratches

1. Be careful not to slide pots and pans across your cooktop. It will leave metal markings on the cooktop surface.

These marks are removable using the CERAMA BRYTE® Ceramic Cooktop Cleaner with a CERAMA BRYTE® Cleaning Pad for Ceramic Cooktops.

2. If pots with a thin overlay of aluminum or copper are allowed to boil dry, the overlay may leave black discoloration on the cooktop.

This should be removed immediately before heating again or the discoloration may be permanent.

NOTE: Carefully check the bottom of pans for roughness that would scratch the cooktop.

Cooktop Seal

To clean the cooktop seal around the edges of the glass, lay a wet cloth on it for a few minutes, then wipe clean with nonabrasive cleaners.

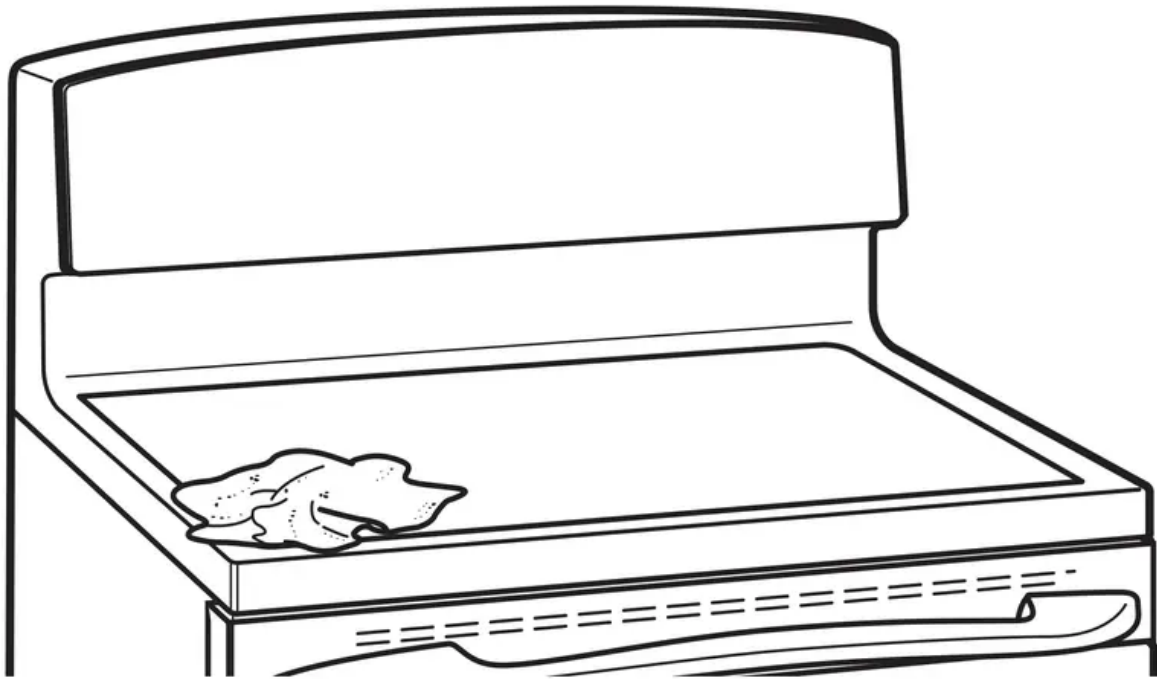

Damage from Sugary Spills and Melted Plastic

Special care should be taken when removing hot substances to avoid permanent damage of the glass surface. Sugary spillovers (such as jellies, fudge, candy, syrups) or melted plastics can cause pitting of the surface of your cooktop (not covered by the warranty) unless the spill is removed while still hot. Special care should be taken when removing hot substances.

Be sure to use a new, sharp razor scraper.

Do not use a dull or nicked blade.

1. Turn off all surface units. Remove hot pans.
2. Wearing an oven mitt:
Use a single-edge razor blade scraper to move the spill to a cool area on the cooktop.
Remove the spill with paper towels.
3. Any remaining spillover should be left until the surface of the cooktop has cooled.
4. Don't use the surface units again until all of the residue has been completely removed.

NOTE: If pitting or indentation in the glass surface has already occurred, the cooktop glass will have to be replaced. In this case, service will be necessary.

Oven Light

WARNING - SHOCK OR BURN HAZARD: Before replacing oven light bulb, disconnect the electrical power to the range at the main fuse or circuit breaker panel. Failure to do so may result in electric shock or burn.

CAUTION - BURN HAZARD: The glass cover and bulb should be removed when cool. Touching hot glass with bare hands or a damp cloth can cause burns.

Oven Light Replacement (on some models)

To remove:

1. Turn the glass cover counter clockwise 1/4 turn until the tabs of the glass cover clear the grooves of the socket. Wearing latex gloves may offer a better grip.
2. Using gloves or a dry cloth, remove the bulb by pulling it straight out.

To replace:

1. Use a new 120/130-volt halogen bulb, not to exceed 50 watts. Replace the bulb with the same type of bulb that was removed. Be sure the replacement bulb is rated 120 volts or 130 volts (NOT 12 volts).
2. Using gloves or a dry cloth, remove the bulb from its packaging. Do not touch the bulb with bare fingers. Oil from skin will damage the bulb and shorten its life.
3. Push the bulb straight into the receptacle all the way.
4. Place the tabs of the glass cover into the grooves of the socket. Turn the glass cover clockwise 1/4 turn.
For improved lighting inside the oven, clean the glass cover frequently using a wet cloth. This should be done when the oven is completely cool.
5. Reconnect electrical power to the oven.

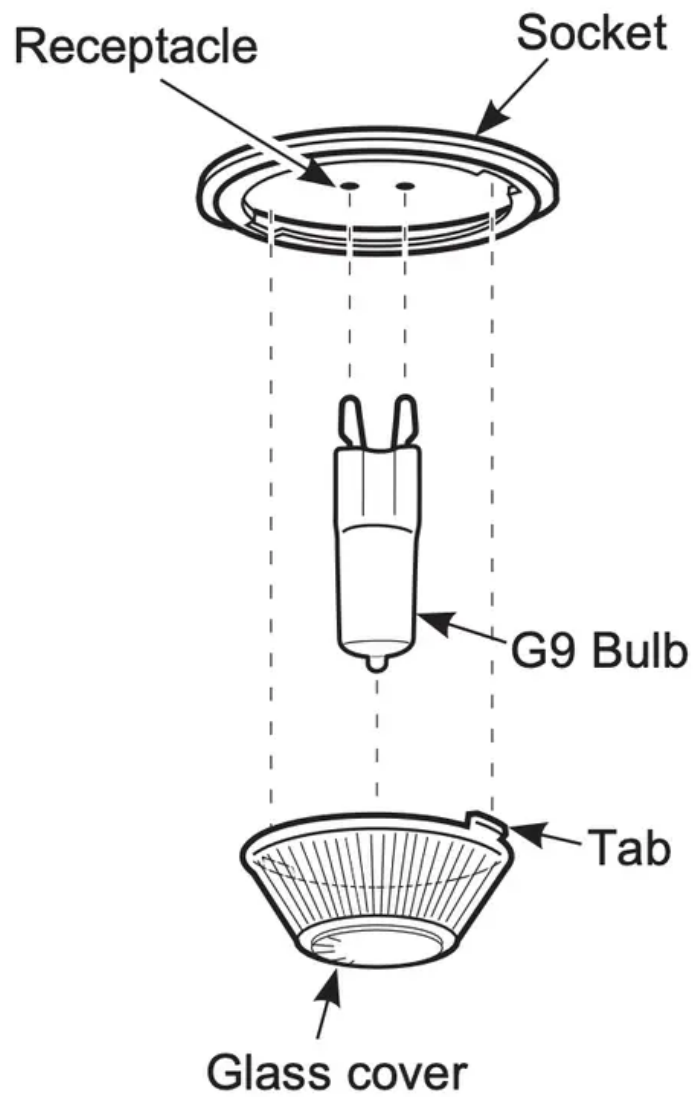

(on some models)

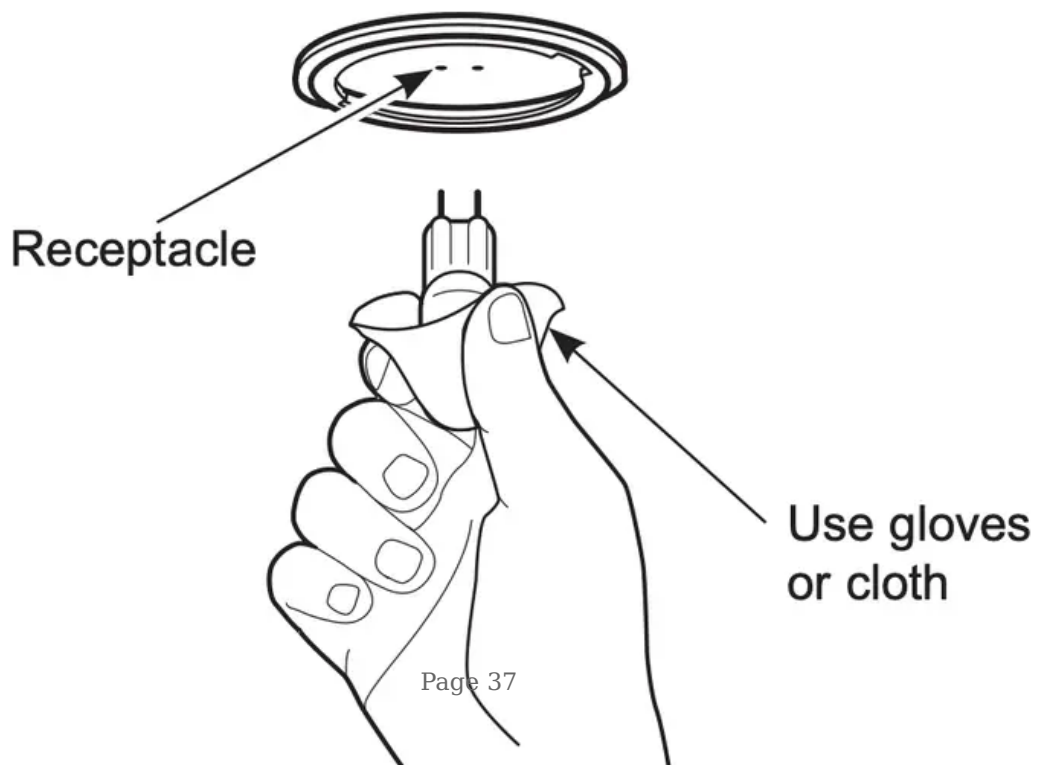

Oven Light Replacement (on some models)

To remove:

1. Turn the glass cover counterclockwise 1/4 turn until the tabs of the glass cover clear the grooves of the socket. Wearing latex gloves may offer a better grip.
2. Remove the bulb by turning it counter-clockwise.

To replace:

1. Replace bulb with a new 40-watt appliance bulb. Insert the bulb and turn it clockwise until it is tight.
2. Place the tabs of the glass cover into the grooves of the socket. Turn the glass cover clockwise 1/4 turn.
For improved lighting inside the oven, clean the glass cover frequently using a wet cloth. This should be done when the oven is completely cool.
3. Reconnect electrical power to the oven.

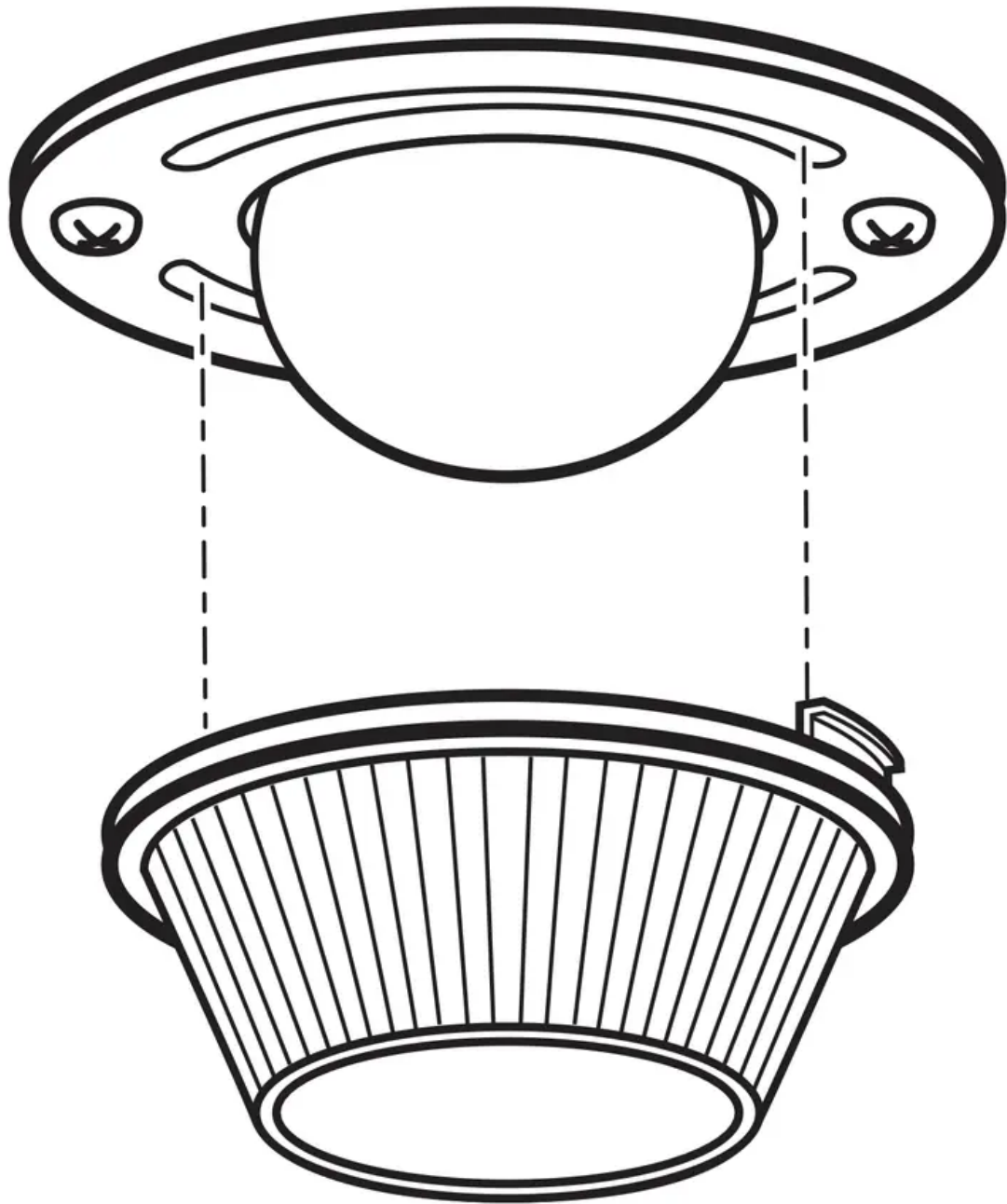

Oven Door

The door is very heavy. Be careful when removing and lifting the door.

Do not lift the door by the handle.

To remove the door:

1. Fully open the door.
2. Pull the hinge locks down toward the door frame, to the unlocked position. A tool, such as a small flat-blade screwdriver, may be required.
3. Firmly grasp both sides of the door at the top.

4. Close door to the door removal position. The door should be open approximately 3" with no obstruction above the door.
5. Lift door up and out until both hinge arms are clear of the slots.

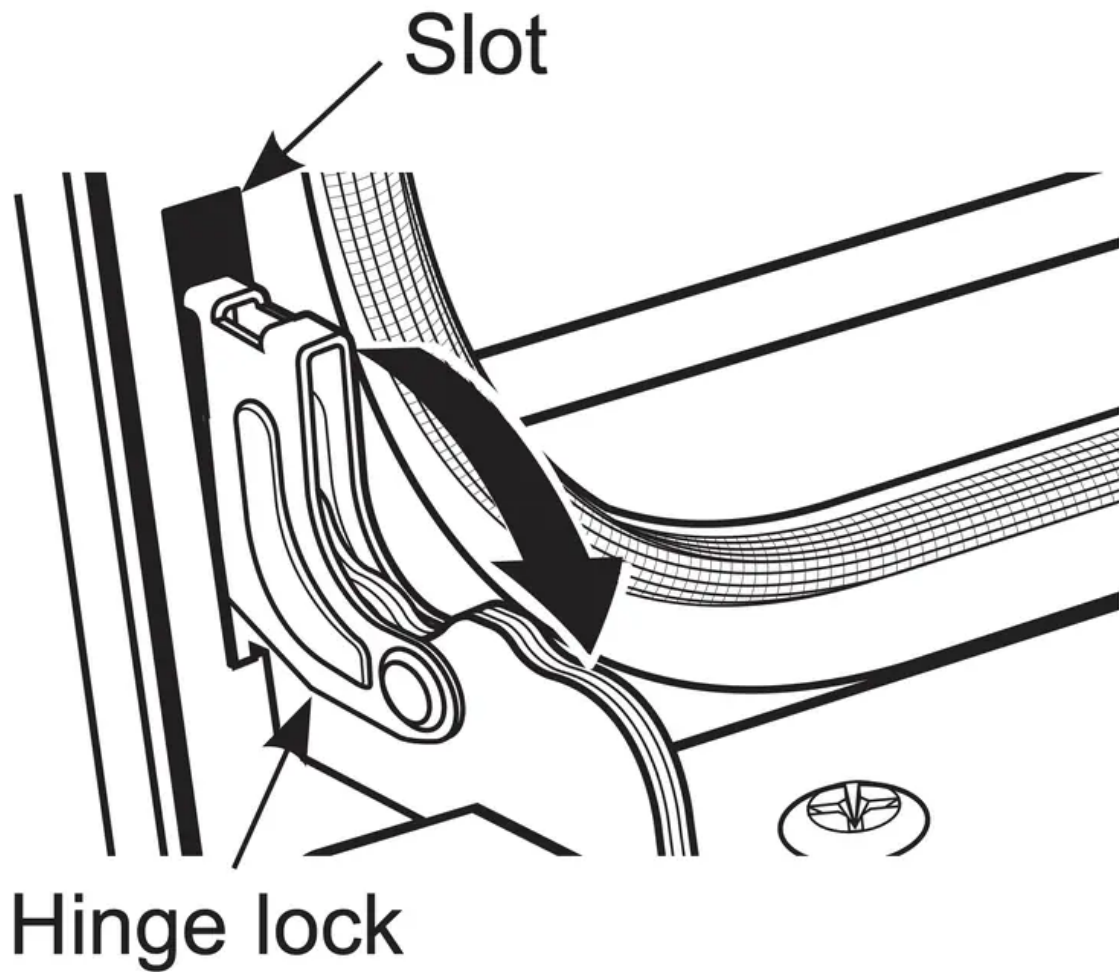

Pull hinge locks down to unlock

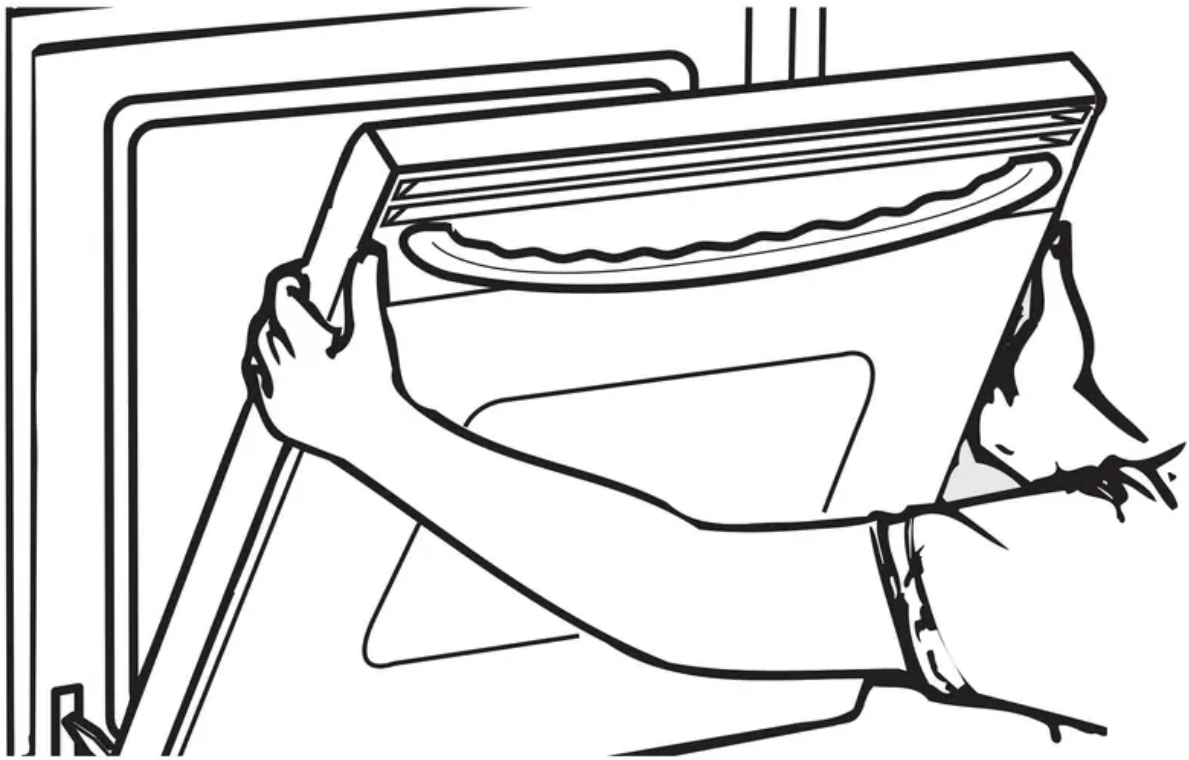

Removal position

To replace the door:

1. Firmly grasp both sides of the door at the top.
2. Starting on the left side, with the door at the same angle as the removal position, seat the indentation of the hinge arm into the bottom edge of the hinge slot. The notch in the hinge arm must be fully seated into the bottom of the slot. Repeat for right side.
3. Fully open the door. If the door will not fully open, the indentation is not seated correctly in the bottom edge of the slot.
4. Push the hinge locks up against the front frame of the oven cavity, to the locked position.
5. Close the oven door.

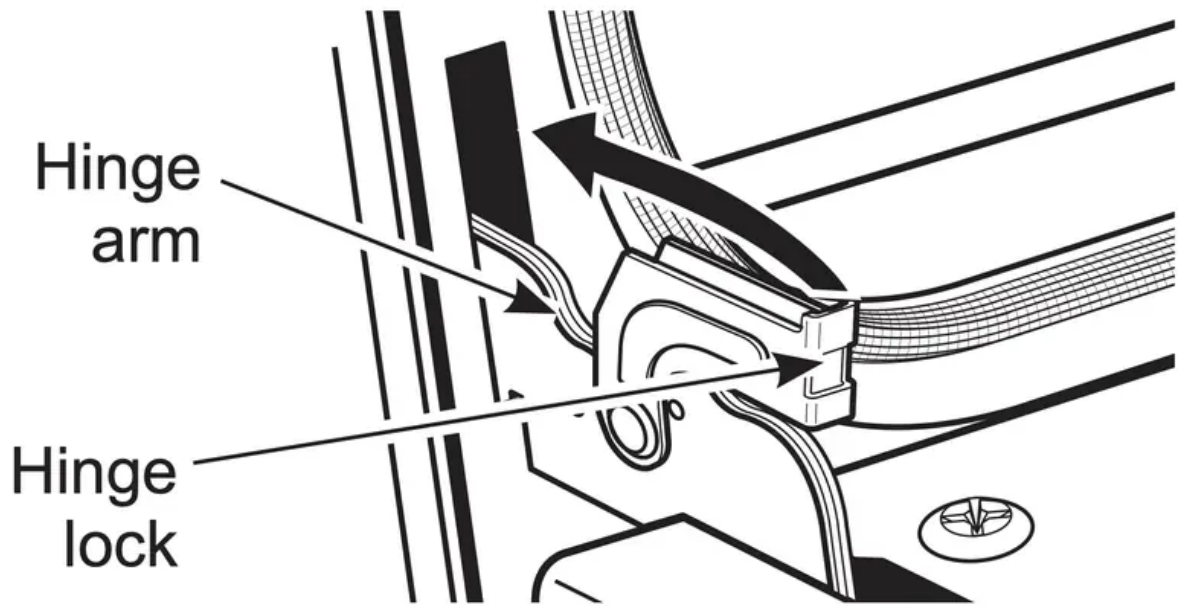

Push hinge locks up to lock

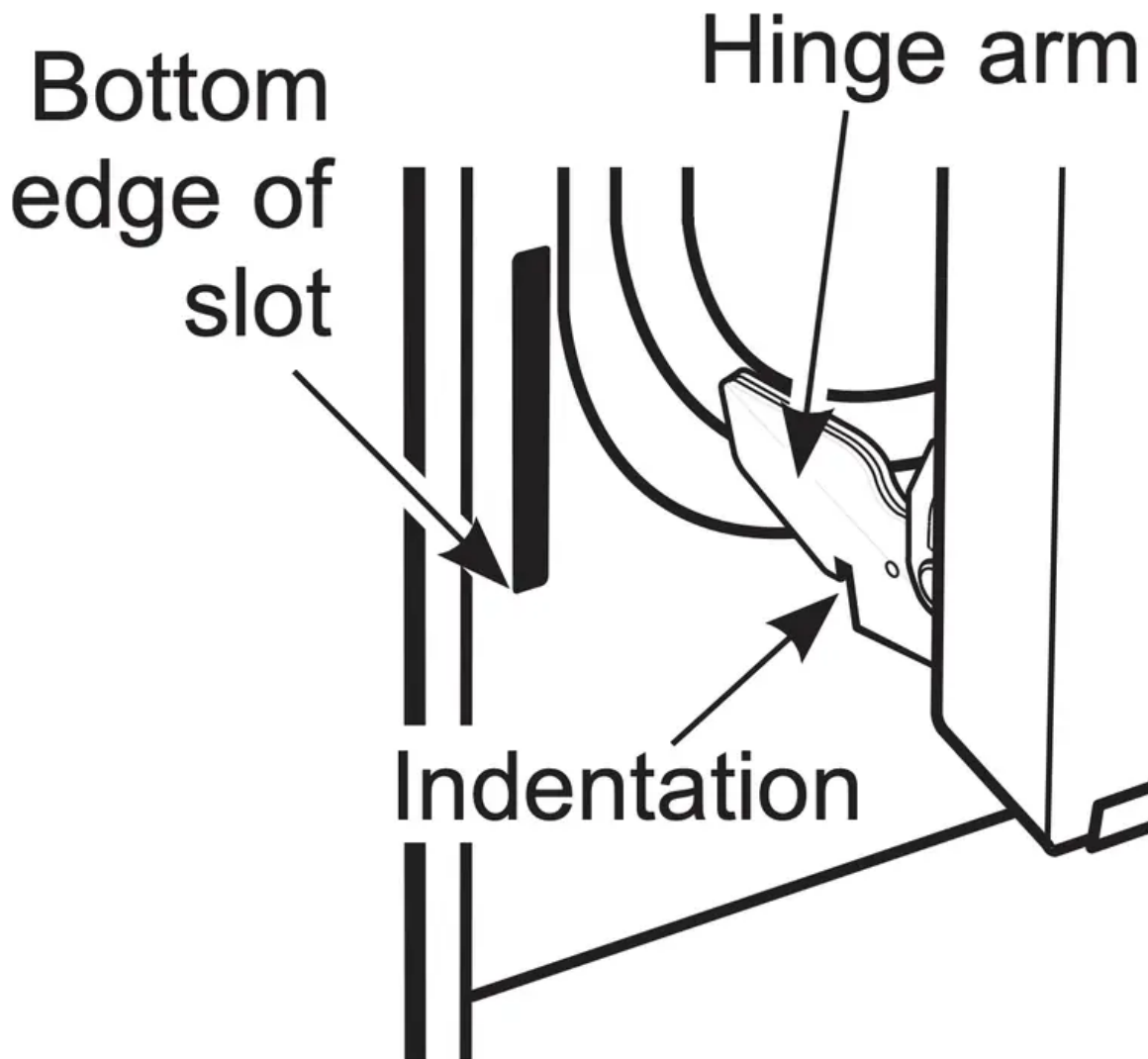

Storage Drawer

To remove the drawer:

1. Pull the drawer out until it stops.
2. Lift the front of the drawer until the stops clear the guides.
3. Remove the drawer.

To replace the drawer:

1. Place the drawer rails on the guides.
2. Push the drawer back until it stops.
3. Lift the front of the drawer and push back until the stops clear the guides.
4. Lower the front of the drawer and push back until it closes.

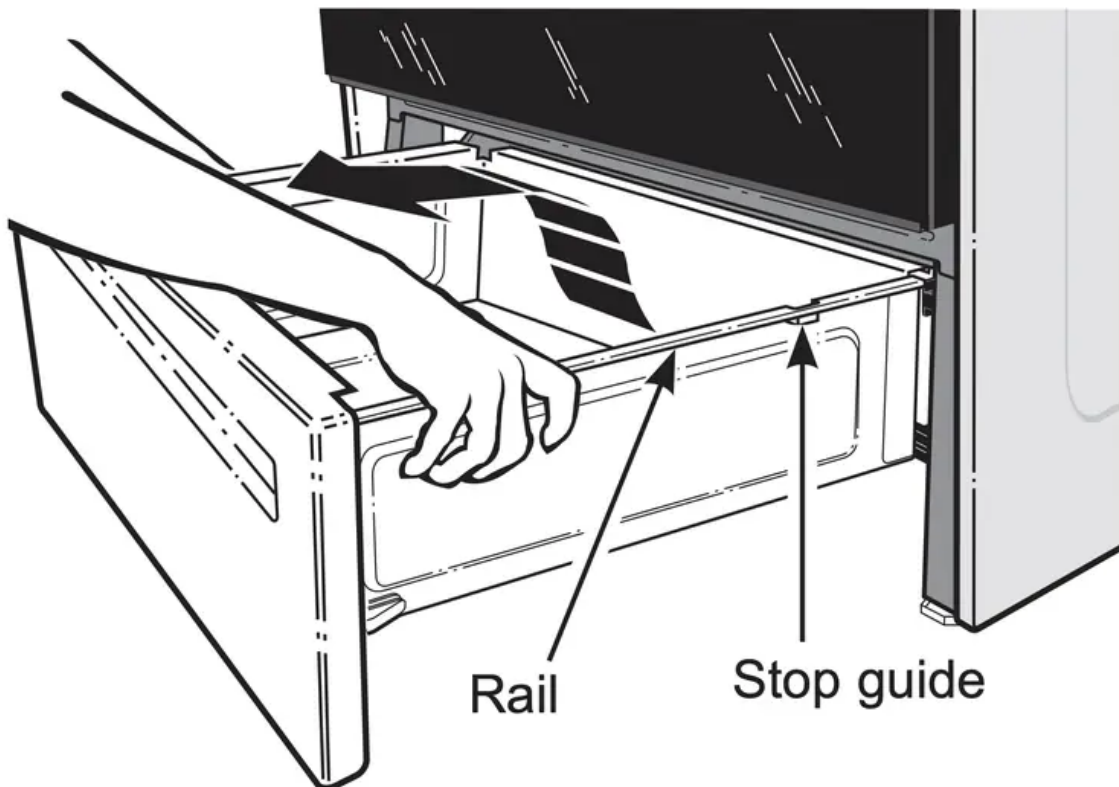

Troubleshooting Tips

| Problem | Possible Cause | What To Do |
|--|--|--|
| Surface units will not maintain a rolling boil or cooking is not fast enough | Improper cookware being used. | Use pans which are flat and match the diameter of the surface unit selected. |
| | In some areas, the power (voltage) may be below. | Cover pan with a lid until desired heat is obtained. |
| Surface units do not work properly | A fuse in your home may be blown or the circuit breaker tripped. | Replace the fuse or reset the circuit breaker. |
| | Cooktop controls improperly set. | Check to see the correct control is set for the surface unit you are using. |
| Surface unit stops glowing when turned to a lower setting | The unit is still on and hot. | This is normal. |
| Scratches (may appear as cracks) on cooktop glass surface | Incorrect cleaning methods being used. | Scratches are not removable. Tiny scratches will become less visible in time as a result of cleaning. |
| | Cookware with rough bottoms being used or coarse particles (salt or sand) were between the cookware and the surface of the cooktop. Cookware has been slid across the cooktop surface. | To avoid scratches, use the recommended cleaning procedures. Make sure bottoms of cookware are clean before use, and use cookware with smooth bottoms. |
| Areas of discoloration on the cooktop | Food spillovers not cleaned before next use. | See the Cleaning the glass cooktop section. |
| | Hot surface on a model with a light-colored cooktop. | This is normal. The surface may appear discolored when it is hot. This is temporary and will disappear as the glass cools. |

| Problem | Possible Cause | What To Do |
|---|--|--|
| Plastic melted to the surface | Hot cooktop came into contact with plastic placed on the hot cooktop. | See the Glass surface-potential for permanent damage section in the Cleaning the glass cooktop section. |
| Pitting (or indentation) of the cooktop | Hot sugar mixture spilled on the cooktop. | Call a qualified technician for replacement. |
| Frequent cycling off and on of surface units | Improper cookware being used. | Use only flat cookware to minimize cycling |
| My new oven doesn't cook like my old one. Is something wrong with the temperature settings? | Your new oven has a different cooking system from your old oven and therefore may cook differently than your old oven. | <p>For the first few uses, follow your recipe times and temperatures carefully.</p> <p>If you still think your new oven is too hot or too cold, you can adjust the temperature yourself to meet your specific cooking preference.</p> <p>NOTE: This adjustment affects Bake, and Convection Bake temperatures; it will not affect Convection Roast, Broil or Clean.</p> |
| Food does not bake properly | Oven controls improperly set. | See the Cooking Modes section. |
| | Rack position is incorrect or rack is not level. | See the Cooking Modes section and Cooking Guide. |
| | Incorrect cookware or cookware of improper size being used. | See the Cookware section. |
| | Oven temperature needs adjustment. | See the Special Features section. |

| Problem | Possible Cause | What To Do |
|---|---|---|
| | Ingredient substitution | Substituting ingredients can change the recipe outcome. |
| Food does not broil properly | Oven controls improperly set. | Make sure you select the appropriate broil mode. |
| | Improper rack position being used. | See Cooking Guide for rack location suggestions. |
| | Food being cooked in a hot pan. | Make sure cookware is cool. |
| | Cookware not suited for broiling. | Use a pan specifically designed for broiling. |
| | Aluminum foil used on the broiling pan and grid has not been fitted properly and slit as recommended. | If using aluminum foil conform to pan slits. |
| | In some areas the power (voltage) may be below. | Preheat the broil element for 10 minutes. |
| Oven temperature too hot or too cold | Oven temperature needs adjustment. | See the Special Features section. |
| Oven does not work or appears not to work | A fuse in your home may be blown or the circuit breaker tripped. | Replace the fuse or reset the circuit breaker. |
| | Oven controls improperly set. | See the Special Features section. |
| | Oven is in Sabbath Mode. | Verify, that the oven is not in Sabbath Mode. See the Special Features section. |
| “Crackling” or “popping” sound | This is the sound of the metal heating and cooling during both the cooking and cleaning functions. | This is normal. |
| | | This is normal. |



| Problem | Possible Cause | What To Do |
|---|---|---|
| Why is my range making a "clicking" noise when using my oven? | Your range cycles the heating elements by turning relays on and off to maintain the oven temperature. | |
| Clock and timer do not work | A fuse in your home may be blown or the circuit breaker tripped. | Replace the fuse or reset the circuit breaker. |
| | Plug on range is not completely inserted in the electrical outlet. | Make sure electrical plug is plugged into a live, properly grounded outlet. |
| | Oven controls improperly set. | See the Using the kitchen timer section |
| Storage drawer won't close | Power cord may be obstructing drawer in the lower back of the range. | Reposition the drawer and power cord. See the Storage Drawer Removal instructions in the Care and cleaning of the range section. |
| | Rear drawer support is on top of the guide rail. | Reposition the drawer. See the Storage Drawer Removal instructions in the Care and cleaning of the range section. |
| Oven door is crooked | The door is out of position. | Because the oven door is removable, it sometimes gets out of position during installation. To straighten the door, re-install the door. See the "Lift-Off Oven Door" instructions in the "Care and Cleaning" section. |
| Oven light does not work | Light bulb is loose or defective. | Tighten or replace bulb. |
| | Pad operating light is broken. | Call for service. |

| Problem | Possible Cause | What To Do |
|---|--|---|
| Oven will not self-clean | The temperature is too high to set a self-clean operation. | Allow the oven to cool and reset the controls. |
| | Oven controls improperly set. | See the Cleaning the Oven section. |
| Excessive smoking during clean cycle | Excessive soil or grease. | Press the Cancel/Off pad. Open the windows to rid the room of smoke. Wait until the LOCKED light goes off. Wipe up the excess soil and reset the clean cycle. |
| Excessive smoking during broiling | Food too close to burner element. | Lower the rack position of the food. |
| Oven door will not open after a clean cycle | Oven too hot. | Allow the oven to cool below locking temperature. |
| Oven not clean after a clean cycle | Oven controls improperly set. | See the Cleaning the Oven section. |
| | Oven was heavily soiled. | Clean up heavy spillovers before starting the clean cycle. Heavily soiled ovens may need to self-clean again or for a longer period of time. |
| "LOCK DOOR" flashes in the display | The self-clean cycle has been selected but the door is not closed. | Close the oven door. Latch the door. |
| DOOR LOCK light is on when you want to cook | The oven door is locked because the temperature inside the oven has not dropped below the locking temperature. | Press the Cancel/Off pad. Allow the oven to cool. |
| | You have a function error code. | Press the Cancel/Off pad. Allow the oven to cool for one hour. |

| Problem | Possible Cause | What To Do |
|--|---|---|
| “F— and a number or letter” flash in the display | | Put the oven back into operation. |
| | If the function code repeats. | Disconnect all power to the oven for at least 30 seconds and then reconnect power. If the function error code repeats, call for service. |
| Display goes blank | A fuse in your home may be blown or the circuit breaker tripped. | Replace the fuse or reset the circuit breaker. |
| | The clock is turned off. | See the Special features section. |
| | Oven is in Sabbath Mode. | Verify that the oven is not in Sabbath Mode. See the Special Features section. |
| Power outage, clock flashes | Power outage or surge | Reset the clock. If the oven was in use, you must reset it by pressing the Cancel/Off pad, setting the clock and resetting any cooking function. |
| “Burning” or “oily” odor emitting from the vent | This is normal in a new oven and will disappear in time. | To speed the process, set a self-clean cycle for a minimum of 3 hours. See the Cleaning the Oven section. |
| Strong odor | An odor from the insulation around the inside of the oven is normal for the first few times the oven is used. | This is temporary and will go away after several uses or a self-clean cycle. |
| Fan noise (on some models) | A convection fan may automatically turn on and off. | This is normal. The fan is designed to operate intermittently to maximize cooking evenness. The convection fan will operate during preheat of the bake cycle. The fan will turn off after |

| Problem | Possible Cause | What To Do |
|---|---|--|
| | | the oven is heated to the set temperature. This is normal. |
| My oven door glass appears to be "tinted" or have a "rainbow" color. Is this defective? | No. The inner oven glass is coated with a heat barrier to reflect the heat back into the oven to prevent heat loss and keep the outer door cool while baking. | This is normal. Under certain light or angles, you may see this tint or rainbow color. |

Warning

This content is compiled from multiple sources and is provided for reference purposes only. It may not be complete or fully applicable to all situations. If you are unable to resolve your issue, please contact the product manufacturer or an authorized service provider for official support.

