

Installation

This dryer must be installed by a qualified technician. The installer is responsible for connecting the dryer to the main power while observing the relevant safety regulations of your area.

What's included

Make sure all the parts are included in the product package. If you have a problem with the dryer or the parts, contact a local Samsung customer center or the retailer.

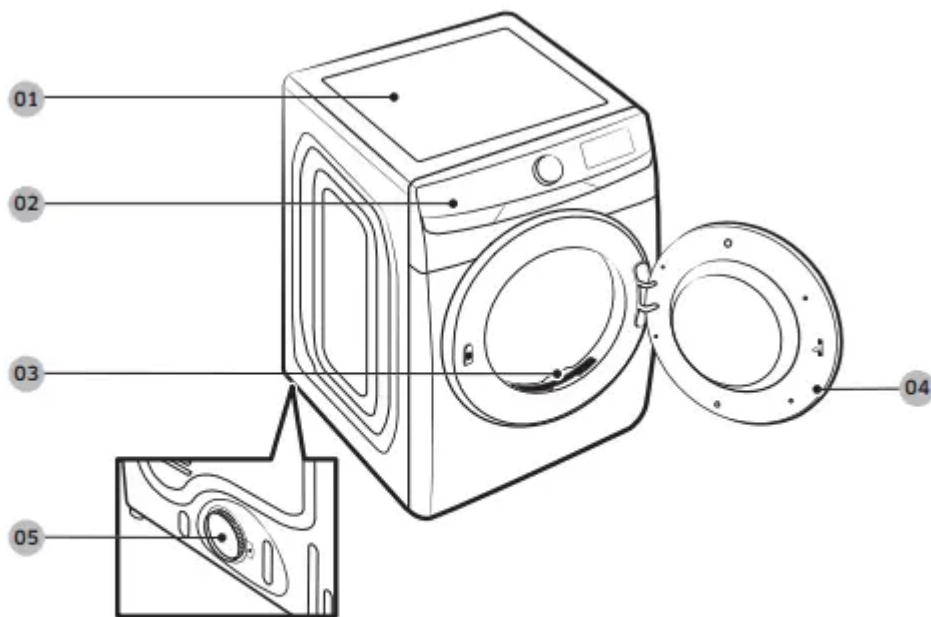

01 Worktop

02 Control panel

03 Lint filter

04 Door

05 Exhaust duct

Operations

WARNING To reduce the risk of fire, electric shock, or injury, read the “Safety information” before operating this appliance.

Control panel

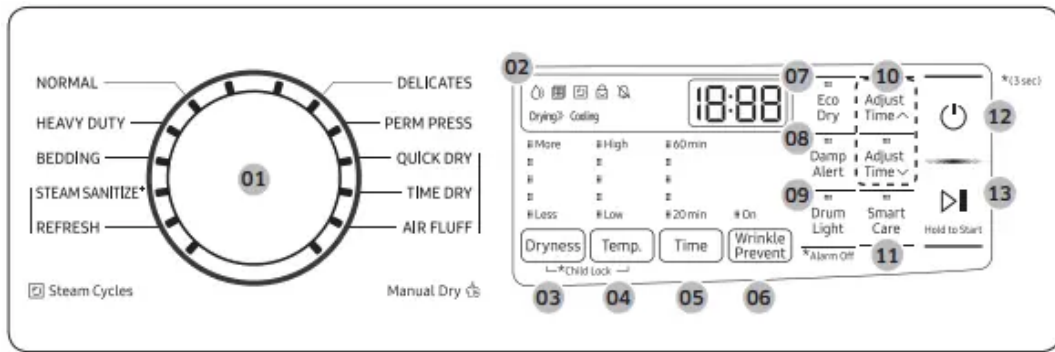

01. Cycle Selector	<p>Turn the Cycle Selector to select the desired cycle. The indicator by the cycle name lights up.</p> <ul style="list-style-type: none"> • Steam Cycles: The dryer sprays water into the drum to deodorize clothes and reduce static electricity and wrinkles. • Manual Dry: The drying time is fixed.
02. Digital Graphic Display	<p>Displays all cycle information, including the cycle time, information code, and operating status.</p>
03. Dryness	<p>Press to select a dry level. You can select from 5 different options (Less to More). Please refer to following recommendations to select the appropriate dryness.</p> <ul style="list-style-type: none"> • For larger or bulkier loads, select More for complete dryness. • For items that needs to lay flat or hang to dry, use Less to partially dry items. <p>NOTE This option is not available with REFRESH, STEAM SANITIZE , TIME DRY, QUICK DRY, and AIR FLUFF.</p>
04. Temp.	<p>Temperature can only be adjusted in TIME DRY cycle. Press to change the temperature of the current cycle. You can select from 5 different options (Low to High). Please select the appropriate temperature depending on the items in the load.</p> <ul style="list-style-type: none"> • High: For sturdy cottons or those labeled Tumble Dry. • Medium: For permanent press, synthetics, lightweight cottons, or items labeled Tumble Dry Medium. • Low: For heat sensitive items labeled Tumble Dry Low or Tumble Dry Warm. Provides the lowest heated drying temperature possible.
05. Time	<p>Press Time to select a drying time for the selected cycle. This is available only with TIME DRY, QUICK DRY, and AIR FLUFF. This button is not available for Sensor Dry cycles because exact drying times are determined by fluctuating humidity levels.</p>
06. Wrinkle Prevent	<p>Wrinkle Prevent provides approximately 180 minutes of intermittent tumbling in unheated air at the end of the cycle to reduce wrinkling. Press Wrinkle Prevent to activate this feature. The load is dry and can be removed at any time during the Wrinkle Prevent cycle.</p>







07. Eco Dry	<p>The Eco Dry function is available with NORMAL and TIME DRY cycles. On NORMAL cycle, the Eco Dry function can increase the drying time up to 3 times depending on the temperature and load while reducing the power consumption.</p> <p>The Eco Dry function can be set to on or off, and it will be stored in memory for the next cycle. If the power cord is unplugged or loses power, the Eco Dry function will be enabled by default.</p>
08. Damp Alert	<p>This alert is available for all Sensor Dry cycles. Available dry levels are Less, Normal, More, and Extra.</p> <p>If a load contains mixed fabrics, the Damp Alert indicator blinks when average dryness of the items in the load is 80 % dry. This lets you take items that you don't want fully dried or that dry quickly out of the dryer early while letting others continue to dry.</p>
09. Drum Light	<p>Press to turn the interior lamp on or off. The lamp stays lit for 2 minutes after it has turned on, regardless of whether the power is on or off or the door is open or closed, and then turns off automatically.</p>
10. Adjust Time	<p>You can change the set time for the selected cycle. This is available only with TIME DRY, QUICK DRY, and AIR FLUFF. To change the cycle time, press Adjust Time \wedge or Adjust Time \vee until the desired time is displayed.</p>
11. Smart Care	<p>The Smart Care function helps you diagnose and troubleshoot your dryer if it has an issue.</p>
12. Power	<p>Press to turn on/turn off the dryer.</p>
13. Start/ Pause (Hold to Start)	<p>Press and hold to start operation or press to stop operation.</p>

NOTE Do not take extremely tangled items from your washer and put them into the dryer. They can degrade the drying efficiency of the dryer or cause the door to open. We recommend that you untangle the items before putting them into the dryer. Also, do not put objects on the dryer, especially on the control panel.

CAUTION Do not spray water directly onto the control panel. This may cause a system failure.

Icon description



	Sensor Dry	This icon appears when the dryer operates the cycle which senses the internal humidity to determine the drying time.
	Filter Check	This icon displays after every load as a reminder to clean the lint filter. Clean the lint filter before every cycle and make sure the filter is properly inserted before starting a cycle.
	Steam	This icon appears when the dryer is in steam process. The dryer sprays water into the drum to deodorize clothes and reduce static electricity and wrinkles.
	Child Lock	This icon indicates that Child Lock is on. For more information on Child Lock, see page 48.
	Alarm Off	This icon indicates that the alarm is off. For more information on Alarm Off, see page 49.

Simple steps to start

1. Press Power to turn the dryer on.
2. Turn the Cycle Selector to select a cycle.
3. Change the cycle settings (Dryness, Temp., and Time) as necessary.
4. Select desired options as necessary.
5. Press and hold Start/Pause (Hold to Start).

To change the cycle during operation

1. Press Start/Pause (Hold to Start) to stop operation.
2. Select a different cycle, and repeat steps 2-4 above if necessary.
3. Press and hold Start/Pause (Hold to Start) again to start the new cycle.

Cycle overview

Standard Cycles

Cycle	Description
NORMAL	<p>For most fabrics including cottons and linens.</p> <p>If Normal is selected, the Eco Dry function is enabled by default. For more information, see Eco Dry in the “Control panel” section.</p>
HEAVY DUTY	<p>For drying items made out of heavy fabrics, such as jeans, corduroys, or work clothes, with high temperature heat.</p>
BEDDING	<p>For bulky items such as blankets, sheets, and comforters.</p>
PERM PRESS	<p>For drying wrinkle-free cottons, synthetic fabrics, knits, and permanent press fabrics automatically.</p>
DELICATES	<p>For heat-sensitive items at a low drying temperature.</p>

Steam Cycles

Use steam to reduce wrinkling and odors on items.

Cycle	Description
STEAM SANITIZE+	<p>Use to sanitize items by applying steam and high-temperature heat to the fabric. This cycle can make items soft and reduce smells. Confirm that the laundry load is wet or partially wet before starting this cycle.</p>
REFRESH	<p>Use to smooth out wrinkles and reduce odors in loads of one to four items. With this cycle selected, a small amount of water is sprayed into the dryer drum after several minutes of tumbling with heat. Before removing the laundry, confirm that the laundry load is dry.</p>

Manual Dry

You can change the drying settings manually to your preference.



Cycle	Description
QUICK DRY	A quick drying cycle that runs for 30 minutes.
TIME DRY	You can specify a cycle time in minutes. If TIME DRY is selected, the Eco Dry function is enabled by default. For more information, see Eco Dry in the “Control panel” section.
AIR FLUFF	Tumbles the load in room temperature air.

Cycle chart

NOTE

For best results, follow the load size recommendations for each dry cycle.

- Large load: Fill the drum to about 3/4 full. Do not add items over this level as they need to tumble freely.
- ◐ Medium load : Fill the drum to about 1/2 full.
- ◑ Small load : Fill the drum with 3-5 items, not more than 1/4 full.

Cycle	Recommended items	Load size	Dry level
NORMAL	Cottons, work clothes, linens, mixed loads	●	Normal dry (Adjustable)
HEAVY DUTY	Heavy fabrics such as jeans, corduroys, heavy work clothes	●	Normal dry (Adjustable)
BEDDING	Bulky items such as blankets, sheets, comforters, pillows	●	Normal dry (Adjustable)
PERM PRESS	Shirts, synthetic fabrics, knits, wrinkle-free cottons, permanent press	◐	Normal dry (Adjustable)
DELICATES	Underwear, blouses, lingerie	◐	Normal dry (Adjustable)
STEAM SANITIZE ⁺	Bedding, curtains, children's clothing	◐	Very dry (Not adjustable)
REFRESH	Shirts, trousers, comforters, pillows	◑	-
QUICK DRY	Small loads	◑	-
TIME DRY	Any load	●	-
AIR FLUFF	Foam, rubber, plastic	◑	-

NOTE

● : factory setting, ◑ : can be selected

Cycle	Functions (Temp. Control)					Time
	High	⋮	⋮	⋮	Low	
NORMAL		●				
HEAVY DUTY	●					
BEDDING	●					
PERM PRESS			●			
DELICATES					●	
STEAM SANITIZE ⁺	●					
REFRESH	●					
QUICK DRY	●					○
TIME DRY	●	○	○	○	○	○
AIR FLUFF						○

Cycle	Options				
	Adjust Time	Damp Alert	Eco Dry	Anti-Static	Wrinkle Prevent
NORMAL		○	○	○	○
HEAVY DUTY		○		○	○
BEDDING		○			○
PERM PRESS		○		○	○
DELICATES		○		○	○
STEAM SANITIZE ⁺					○
REFRESH					○
QUICK DRY	○				○
TIME DRY	○		●	○	○

Special features

Child Lock

Child Lock prevents children from playing with the dryer. When Child Lock is activated, all buttons except for the Power button are disabled.

To activate/deactivate Child Lock, simultaneously press and hold Dryness and Temp. for 3 seconds.

NOTE Once Child Lock is activated, it will remain active even after you restart the dryer. If other buttons, except for the Power button, do not respond, check the Child Lock indicator. If the indicator is on, follow the instructions above to turn Child Lock off.

Smart Care

To enable this function, you must first download the SmartThings app at the Play Store or the App Store and install it on a mobile device featuring a camera function. The Smart

Care function has been optimized for Galaxy & iPhone series (applicable models only).

1. When the dryer detects an issue to check, an information code appears on the display. To enter Smart Care mode, press Smart Care.
2. The dryer starts the self-diagnosis procedure and displays an information code if a problem is detected.

3. Run the SmartThings app on your mobile device, and then tap Smart Care.
4. Put the mobile device close to the dryer's display so that the smartphone camera and the dryer face each other. The app automatically recognizes the information code.
5. When the information code is recognized correctly, the app provides detailed information about the problem with applicable solutions.

NOTE

- The function name, Smart Care, may differ depending on the language.
- If light is reflected off the dryer's display, the app may fail to recognize the information code.
- If the app fails to recognize the information code, you can enter the code manually in the app.

Alarm off

You can turn the alarm on or off. When the alarm is off, the melody of cycle completion and the power-off beep will not sound. However, the other sounds stay active.

- Press and hold Drum Light for 3 seconds.
- Your setting will be retained even after you turn off the dryer. You can turn the alarm back on by pressing and holding the same button for 3 seconds.

Maintenance

Keep the dryer clean for best performance and to lengthen its life cycle.

WARNING

Certain internal parts are intentionally not grounded and may present a risk of electric shock only during servicing.

Service Personnel - Do not contact the following parts while the appliance is energized: Control board and inlet valve.

Cleaning

Control panel

- Clean with a soft, damp cloth. Do not use abrasive substances.
- Do not spray liquid cleaning agents directly onto the dryer display.
- Some laundry pre-treatment soil and stain removers may damage the control panel.
- When using liquid cleaning agents, apply them to the cleaning cloth. Do not apply them directly to the dryer. Wipe up any spills or overspray immediately.

Drum

- Remove any stains from the drum with an all-purpose cleaner.
- Tumble old towels or rags to remove any remaining stains or cleaning substances. Stains may still be visible, but will not affect subsequent loads.

Powder coated drum

To clean the powder coated drum, use a damp cloth with a mild, non-abrasive cleaner suitable for easily marred surfaces. Remove cleaner residue and dry with a clean cloth.

Dryer exterior

- Clean with a soft, damp cloth. Do not use abrasive substances.
- Protect the surface from sharp objects.
- Do not place any heavy or sharp objects or a detergent container on the dryer. They can scratch or damage the top cover of the dryer.
- The dryer has a high-gloss finish on the entire surface. Be careful not to scratch or damage the surface.

Exhaust system

- Check and clean the exhaust system on a regular basis to maintain optimum performance.
- The external exhaust hood must be cleaned frequently to ensure proper airflow.

Troubleshooting

Checkpoints

If the dryer operates abnormally, first check the list of problems in the table below and try the suggested actions.

Problem	Action
Does not run.	<p>Make sure the door is latched shut.</p> <p>Make sure the power cord is plugged into a live electrical outlet.</p> <p>Check your home's circuit breakers or fuses.</p> <p>Press or tap Start/Pause (Hold to Start) again if the door was opened during a cycle.</p> <p>Clean the lint filter.</p>
Does not heat.	<p>Check your home's circuit breakers or fuses.</p> <p>Some cycles do not require heat. Check the selected cycle again.</p> <p>For a gas dryer, make sure the gas supply is on.</p> <p>Clean the lint filter and exhaust duct.</p> <p>The dryer may have moved into the cool-down phase of the cycle.</p> <p>Turn off the Eco Dry option for the NORMAL or TIME DRY cycles. When the Eco Dry option is on, the dryer performs an air dry process in the beginning of the cycle to reduce energy consumption. The air dry process does not use heated air, so you may feel that the dryer is not being heated, but this is normal.</p>
Does not dry.	<p>Check all of the above, plus...</p> <p>Make sure the exhaust hood outside your home can open and close freely.</p> <p>Check the exhaust system for lint buildup. Ducting should be inspected and cleaned annually.</p> <p>Use a 4" rigid metal exhaust duct.</p> <p>Do not overload. 1 wash load = 1 dryer load.</p> <p>Dry heavy items and light weight items separately.</p> <p>Large, bulky items, such as blankets or comforters, may require repositioning to ensure even drying.</p>



	<p>Make sure that your washer is draining properly and extracting adequate water from the load.</p> <p>The load may be too small to tumble properly. Add a few towels and restart the dryer.</p> <p>The load may be too large to tumble properly. Remove some items and restart the dryer.</p> <p>Clean the lint filter.</p>
<p>Is noisy.</p>	<p>Check the load for objects such as coins, loose buttons, nails, etc. Remove promptly.</p> <p>It is normal to hear the dryer gas valve or heating element cycle on and off during the drying cycle.</p> <p>Make sure the dryer is leveled properly as outlined in the installation instructions.</p> <p>It is normal for the dryer to hum due to the high velocity of air moving through the dryer drum, fan, or exhaust system.</p>
<p>Dries unevenly.</p>	<p>Seams, pockets, and other similarly heavy areas may not be completely dry when the rest of the load has reached the selected dryness level. This is normal. You can choose a higher dryness level or a cycle that involves a higher dryness level.</p> <p>If one heavy item is dried with a light weight load, such as one towel with sheets, it is possible that the heavy item will not be completely dry when the rest of the load has reached the selected dryness level.</p> <p>For the best drying results, dry heavy items and light weight items separately.</p>



<p>Has odors.</p>	<p>Household odors from paint, varnish, strong cleaners, etc. may enter the dryer with the surrounding room air. This is normal as the dryer draws the air from the room, heats it, pulls it through the tumbler, and exhausts it outside.</p> <p>When these odors linger in the air, completely ventilate the room before using the dryer.</p> <p>Use the REFRESH cycle. If odors persist, wash and dry the items again.</p>
<p>Lint on clothes.</p>	<p>Make sure the lint filter is cleaned before every load. For clothes that naturally build up lint, clean the filter during the cycle.</p> <p>Some fabrics are lint producers (for example, a fuzzy white cotton towel) and they must be dried separately from clothes that are lint trappers (for example, a pair of black linen pants).</p> <p>Divide larger loads into smaller loads for drying.</p> <p>Check pockets thoroughly before drying, then dry clothes.</p> <p>Remove lint inside the drum before drying a load.</p>
<p>Items still wrinkled after Wrinkle Prevent (Wrinkle Away, Wrinkle Release).</p>	<p>Small loads of 1 to 4 items work best.</p> <p>Load fewer items. Load similar-type items.</p> <p>Take out the items immediately after drying is complete.</p>
<p>Water drips from the nozzle when the Steam cycles starts.</p>	<p>This is steam condensation. The dripping water will stop after a short time.</p>
<p>Sprayed water is not visible during Steam cycles.</p>	<p>Sprayed water is difficult to see when the door is closed.</p>
<p>Extended time.</p>	<p>Sensor Dry automatically senses the moisture in the load and shuts the dryer off when the selected dryness level is reached. The drying time can change according to the type and amount of laundry. See the cycle chart for reference.</p>

If a problem persists, contact a local Samsung service center.



Information codes

If the dryer fails to operate, you may see an information code on the display panel. To determine what you should do, check the list of codes in the table below, and then try the suggested actions.



Code	Action
dC	<p>Operating the dryer with the door open.</p> <ul style="list-style-type: none"> • Make sure the door is properly closed. • Make sure laundry is not caught in the door.
FC	<p>Invalid power source frequency.</p> <ul style="list-style-type: none"> • Try restarting the cycle. • If this information code remains, contact a Samsung service center.
AC	<p>Electronic control problem (Invalid Communication).</p> <ul style="list-style-type: none"> • Contact a Samsung service center.
HC	<p>High temperature heating check.</p> <ul style="list-style-type: none"> • Clean the lint filter. • If this information code remains, contact a Samsung service center.
9C1	<p>The electronic control needs to be checked.</p> <ul style="list-style-type: none"> • Check if power is supplied properly. • If the information code remains, contact a Samsung service center.
tC	<p>The Thermistor1 resistance is very low or high.</p> <ul style="list-style-type: none"> • Check for a clogged lint screen. • Check if the vent system is restricted. • If this information code remains, contact a Samsung service center.
tC5	<p>The Thermistor2 resistance is very low or high.</p> <ul style="list-style-type: none"> • Check for a clogged lint screen. • Check if the vent system is restricted. • If this information code remains, contact a Samsung service center.
dF	<p>Incorrect door switch.</p>



	<ul style="list-style-type: none">• Contact a Samsung service center.
3C	<p>The PBA needs to be checked.</p> <ul style="list-style-type: none">• Unplug the power plug and contact a Samsung service center.

If any information code keeps appearing on the display, contact a Samsung service center.

Warning

This content is compiled from multiple sources and is provided for reference purposes only. It may not be complete or fully applicable to all situations. If you are unable to resolve your issue, please contact the product manufacturer or an authorized service provider for official support.

Document generated by [ManualsFile](#)

