

# INSTALLATION

## Installation Place Requirements

### Location

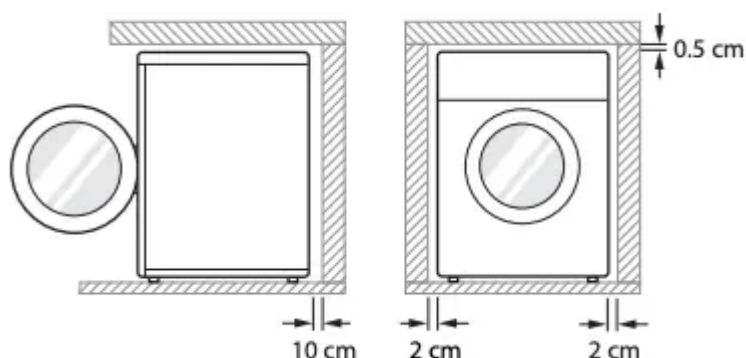

**Level floor** : Allowable slope under the entire appliance is 1°.

**Power outlet** : Must be within 1 meter of either side of the location of the appliance.

- Do not overload the outlet with more than one appliance.

**Additional Clearance** : For the wall, 10 cm: rear/2 cm: right & left side

- Do not place or store laundry products on top of the appliance at any time. These products may damage the finish or controls.



### WARNING

- The plug must be plugged into an appropriate outlet that is properly installed and grounded in accordance with all local codes and ordinances.

### Positioning

- Install the appliance on a flat hard floor.
- Make sure that air circulation around the appliance is not impeded by carpets, rugs, etc.
- Never try to correct any unevenness in the floor with pieces of wood, cardboard or similar materials under the appliance.
- If it is impossible to avoid positioning the appliance next to a gas cooker or coal burning stove, an insulation (85x60 cm) covered with aluminum foil on the side facing the cooker or stove must be inserted between the two appliances.
- Do not install the appliance in rooms where freezing temperatures may occur. Frozen hoses may burst under pressure. The reliability of the electronic control unit may be impaired at temperatures below freezing point.

- Ensure that when the appliance is installed, it is easily accessible for an engineer in the event of a breakdown.
- With the appliance installed, adjust all four feet using the transit bolt spanner provided to ensure the appliance is stable, and a clearance of approximately 5 mm is left between the top of the appliance and the underside of any worktop
- If the appliance is delivered in winter and temperatures are below freezing, place the appliance at room temperature for a few hours before putting it into operation.



#### **WARNING**

- This equipment is not designed for maritime use or for use in mobile installations such as caravans, aircraft etc.

#### **Electrical Connection**

- Do not use an extension cord or double adapter.
- Always unplug the appliance and turn off the water supply after use.
- Connect the appliance to an earthed socket in accordance with current wiring regulations.
- The appliance must be positioned so that the plug is easily accessible.
- Repairs to the appliance must only be carried out by qualified personnel. Repairs carried out by inexperienced persons may cause injury or serious malfunctioning. Contact your local service centre

#### **Unpacking and Removing Transit Bolts**

1 Lift the appliance off the foam base.

- After removing the carton and shipping material, lift the appliance off the foam base. Make sure the tub support comes off with the base and is not stuck to the bottom of the appliance.
- If you must lay the appliance down to remove the carton base, always protect the side of the appliance and lay it carefully on its side. Do not lay the appliance on its front or back.

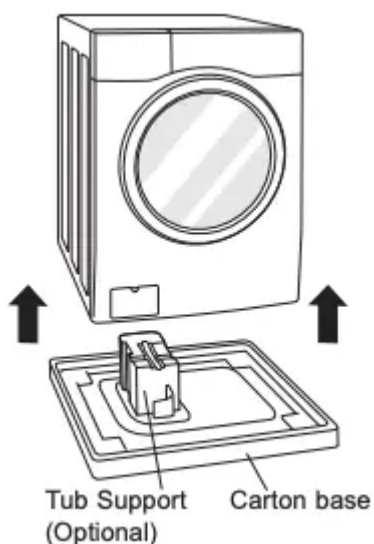

2 Remove the bolt assemblies.

- Starting with the bottom two transit bolts, use the spanner (included) to fully loosen all transit bolts by turning them counterclockwise. Remove the bolt assemblies by wiggling them slightly while pulling them out.

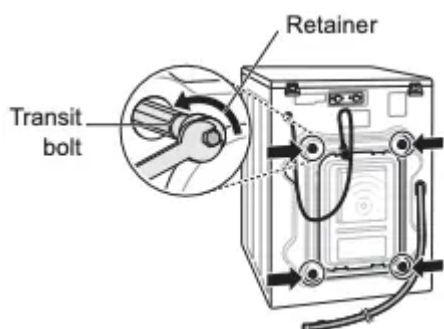

3 Install the hole caps.

- Locate the hole caps included in the accessory pack or attached on the back.

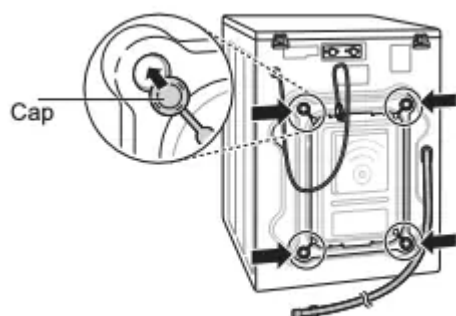

#### NOTE

- Save the bolt assemblies for future use. To prevent damage to internal components, Do not transport the washing machine without reinstalling the transit bolts.

- Failure to remove transit bolts and retainers may cause severe vibration and noise, which can lead to permanent damage to the washing machine. The cord is secured to the back of the washing machine with a transit bolt to help prevent operation with transit bolts in place.

### Using Anti-Slip Sheets (Optional)

If you install the appliance on a slippery surface, it may move because of excessive vibration. Incorrect leveling may cause malfunction through noise and vibration. If this occurs, install the anti-slip sheets under the leveling feet and adjust the level.

1 Clean the floor to attach the anti-slip sheets.

- Use a dry rag to remove and clean foreign objects and moisture. If moisture remains, the anti-slip sheets may slip.

2 Adjust the level after placing the appliance in the installation area.

3 Place the adhesive side of the anti-slip sheets on the floor.

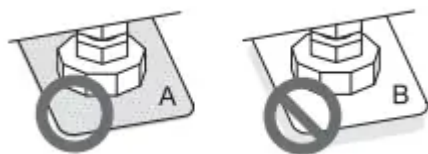
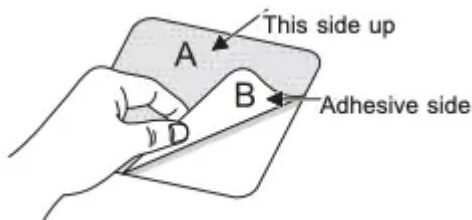

4 Ensure the appliance is level.

- Push or rock the top edges of the appliance gently to make sure that the appliance does not rock. If the appliance rocks, level the appliance again.

#### NOTE

- You can obtain anti-slip sheets from the LG Service Centre.

### Wooden Floors (Suspended Floors)

- Wooden floors are particularly susceptible to vibration.

- To prevent vibration we recommend you place rubber cups at least 15 mm thick of the each foot of the appliance, secured to at least two floor beams with screws.

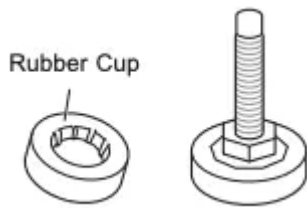

- If possible install the appliance in one of the corners of the room, where the floor is more stable.
- Fit the rubber cups to reduce vibration

#### NOTE

- Proper placement and leveling of the washing machine will ensure long, regular, and reliable operation.
- The washing machine must be 100% horizontal and stand firmly in position.
- It must not 'Seesaw' across corners under the load.
- The installation surface must be clean, free from floor wax and other lubricant coatings.
- Do not let the feet of the washing machine get wet. Failure to do so may cause vibration or noise.
- You can obtain rubber cups (p/no.4620ER4002B) from the LG Service Centre.

### Leveling the Appliance

If the floor is uneven, turn the adjustable feet as required (Do not insert pieces of wood etc. under the feet). Make sure that all four feet are stable and resting on the floor and then check that the appliance is perfectly level (Use a spirit level).

- Once the appliance is level, tighten the lock nuts up towards the base of the appliance. All lock nuts must be tightened.

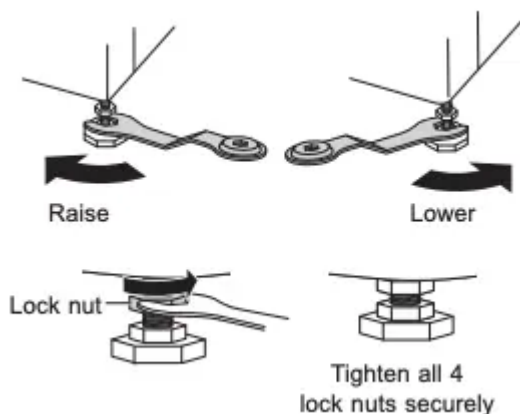

### Diagonal Check

- When pushing down the edges of the top plate diagonally, the appliance should not move up and down at all (check both directions). If the appliance rocks when pushing the machine top plate diagonally, adjust the feet again.

## NOTE

- Timber or suspended type flooring may contribute to excessive vibration and unbalance.
- If the washing machine is installed on a raised platform, it must be securely fastened in order to eliminate the risk of falling off.

## Connecting the Water Supply Hose

- Water pressure must be between 0.1 MPa and 1.0 MPa (1.0–10.0 kgf/cm<sup>2</sup>).
- Do not strip or crosstread when connecting supply hose to the valve.
- If the water pressure is more than 1.0 MPa, a decompression device should be installed.
- Periodically check the condition of the hose and replace the hose if necessary

## Checking the Rubber Seal on the Water Supply Hose

Two rubber seals are supplied with the water inlet hoses. They are used for preventing water leaks. Make sure the connection to taps is sufficiently tight.

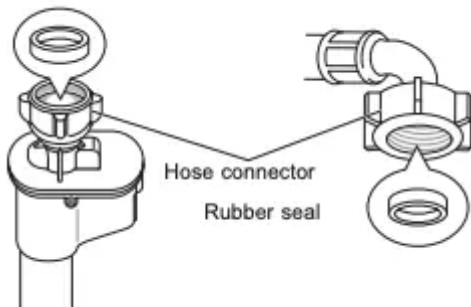
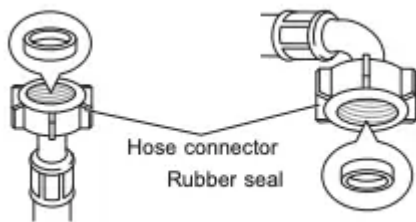

## Connecting Hose to Water Tap

### Connecting Screw-Type Hose to Tap with Thread

Screw the hose connector onto the water supply tap.

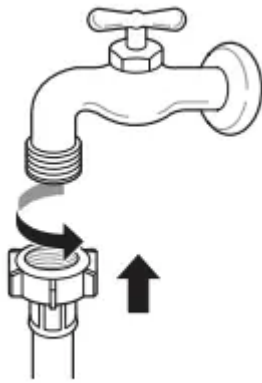

### Connecting Screw-Type Hose to Tap Without Thread

1 Loose the four fixing screws.

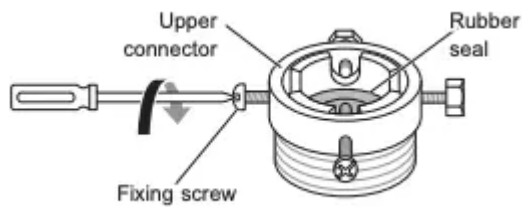

2 Remove the guide plate if the tap is too large to fit the adapter.

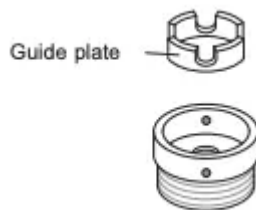

3 Push the adapter onto the end of the tap so that the rubber seal forms a watertight connection. Tighten the four fixing screws.



4 Push the supply hose vertically upwards so that the rubber seal within the hose can adhere completely to the tap and then tighten it by screwing it to the right.

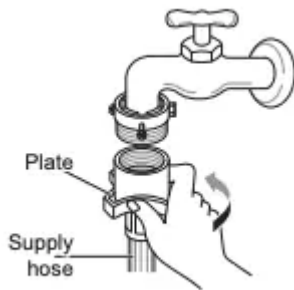

### Connecting One Touch Type Hose to Tap Without Thread

1 Unscrew the adapter ring plate and loose the four fixing screws.

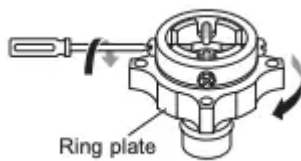

2 Remove the guide plate if the tap is too large to fit the adapter.

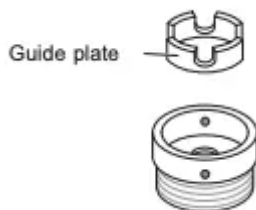

3 Push the adapter onto the end of the tap so that the rubber seal forms a watertight connection. Tighten the four fixing screws and the adapter ring plate.

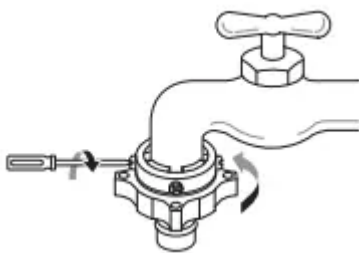

4 Pull the connector latch plate down, push the supply hose onto the adapter, and release the connector latch plate. Make sure the adapter locks into place.

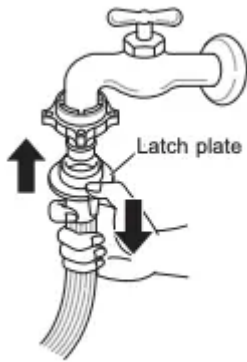

**NOTE**

- Before connecting the supply hose to the water tap, turn on the water tap to flush out foreign substances (dirt, sand, sawdust, and etc.) in the water lines. Let the water drain into a bucket, and check the water temperature.

**Connecting Hose to Appliance**

Attach the hot water line to the hot water supply on the back of the washer. Attach the cold water line to the cold water supply on the back of the washer.

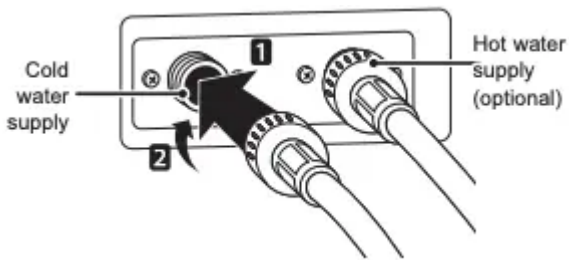

**NOTE**

- After completing connection, if water leaks from the hose, repeat the same steps. Use the most conventional type of tap for the water supply. In case the tap is square or too big, remove the guide plate before inserting the tap into the adaptor.

Using the Horizontal Tap

Horizontal tap



Extension tap



Square tap



## Installing the Drain Hose

- The drain hose should not be placed higher than 100 cm above the floor. Water in the appliance may not drain or may drain slowly.
- Securing the drain hose correctly will protect the floor from damage due to water leakage.
- If the drain hose is too long, do not force it back into the appliance. This will cause abnormal noise.

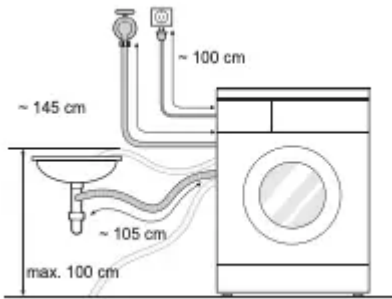

- When installing the drain hose to a sink, secure it tightly with string.
- Securing the drain hose correctly will protect the floor from damage due to water leakage.

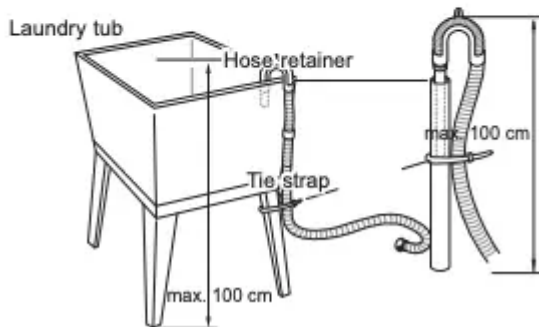
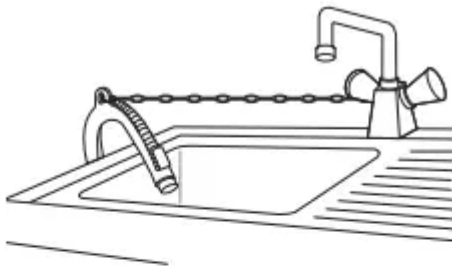

# OPERATION

## Using the Washing Machine

Before the first wash, select a washing programme, allow the washing machine to wash without clothing. This will remove residue and water from the drum that may have been left during manufacturing.

- 1 Sort laundry and load items.
- Sort laundry by fabric type, soil level, colour and load size as needed. Open the door and load items into the washing machine.
- Sort laundry by fabric type, soil level, colour and load size as needed. Open the door and load items into the washing machine.

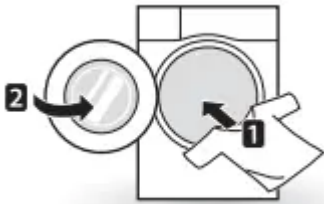

- 2 Add cleaning products and/or detergent and softener.
- Add the proper amount of detergent with the detergent measuring cup to the washing drum evenly.
- Add the proper amount of detergent to the detergent dispenser drawer. If desired, add bleach or fabric softener to the appropriate areas of the dispenser.



- 3 Turn on the washing machine.
- Press the Power button to turn on the washing machine.



- 4 Choose the desired washing cycle.
- Press the programme button repeatedly or turn the cycle selector knob until the desired cycle is selected.
- Press the cycle button repeatedly until the desired cycle is selected.
- Press the cycle button repeatedly or turn the cycle selector knob until the desired cycle is selected.



- 5 Begin cycle.
- Press the Start/Pause button to begin the cycle. The washing machine will agitate briefly without water to measure the weight of the load. If the Start/Pause button is not pressed within 5 minutes, the washing machine will shut off and all settings will be lost.



- 6 End of cycle.
- When the cycle is finished, a melody will sound. Immediately remove your clothing from the washing machine to reduce wrinkling. Check around the door seal when removing the load for small items that may be caught in the seal.

## Sorting Laundry

- 1 Look for a care label on your clothes.
- This will tell you about the fabric content of your garment and how it should be washed.

- Symbols on the care labels.

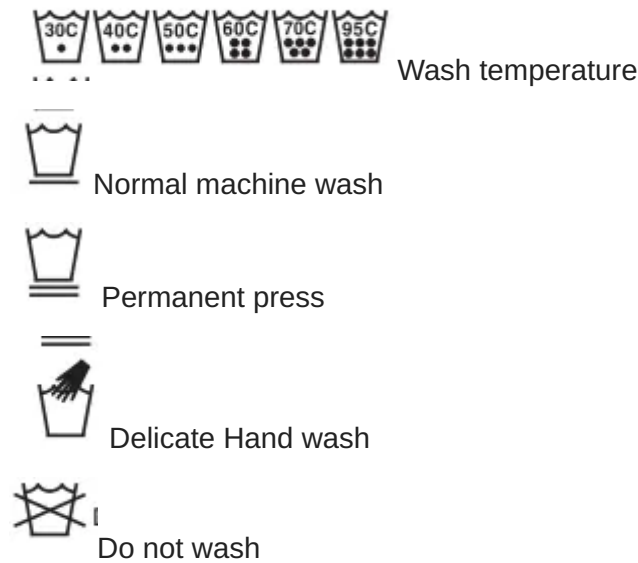

- 2 Sorting laundry.

- To get the best results, sort clothes into loads that can be washed with the same wash cycle.
- Different fabrics need to be washed at varying temperatures and spin speeds.
- Always sort dark colours from pale colours and whites. Wash separately as dye and lint transfer can occur causing discolouration of white and pale garments. If possible, do not wash heavily soiled items with lightly soiled ones.

–Soil (Heavy, Normal, Light) : Separate clothes according to amount of soil.

– Colour (White, Lights, Darks): Separate white fabrics from coloured fabrics.

– Lint (Lint producers, Collectors): Wash lint producers and lint collectors separately

- 3 Caring before loading.

- Combine large and small items in a load. Load large items first.
- Large items should not be more than half the total wash load. Do not wash single items. This may cause an unbalanced load. Add one or two similar items.
- Check all pockets to make sure that they are empty. Items such as nails, hair clips, matches, pens, coins and keys can damage both your washing machine and your clothes.

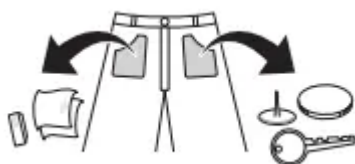

- Close zippers, hooks and strings to make sure that these items don't snag on other clothes.
- Pre-treat dirt and stains by brushing a small amount of detergent dissolved water onto stains to help lift dirt.

- Check the folds of the flexible gasket (gray) and remove any small articles.



- Check inside the drum and remove any items from a previous wash.

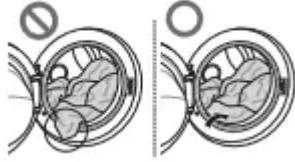

- Remove any clothing or items from the flexible gasket to prevent clothing and gasket damage.

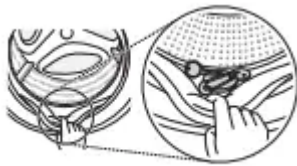

## Adding Cleaning Products

### Detergent Dosage

- Detergent should be used according to the instruction of the detergent manufacturer and selected according to type, colour, soiling of the fabric and washing temperature.
- If too much detergent is used, too many suds can occur and this will result in poor washing results or cause heavy load to the motor.
- If you wish to use liquid detergent follow the guidelines provided by the detergent manufacturer.
- You can pour liquid detergent directly into the main detergent drawer if you are starting the cycle immediately.
- Do not use liquid detergent if you are using Time delay, or if you have selected Pre Wash, as the liquid may harden.
- If too many suds occur, reduce the detergent amount.
- Detergent usage may need to be adjusted for water temperature, water hardness, size and soil level of the load. For best results, avoid oversudsing.
- Refer to the label of the clothes, before choosing the detergent and water temperature.
- When using the washing machine, use designated detergent for each type of clothing only:
  - General powdered detergents for all types of fabric
  - Powdered detergents for delicate fabric
  - Liquid detergents for all types of fabric or designated detergents only for wool



- For better washing performance and whitening, use detergent with the general powdered bleach.
- Detergent is flushed from the dispenser at the beginning of the cycle.

**NOTE**

- Do not let the detergent harden. Doing so may lead to blockages, poor rinse performance or odour.
- Full load : According to manufacturer's recommendation.
- Part load : 3/4 of the normal amount
- Minimum load : 1/2 of full load

**Adding Detergent and Fabric Softener**

Adding Detergent

- Main wash only → 
- Pre wash+Main wash → 

**NOTE**

- Too much detergent, bleach or softener may cause an overflow.
- Be sure to use the appropriate amount of detergent.

Adding Fabric Softener

- Do not exceed the maximum fill line. Overfilling can cause early dispensing of the fabric softener, which may stain clothes. Close the dispenser drawer slowly.

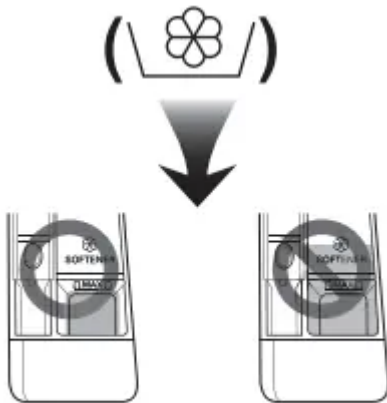

- Do not leave the fabric softener in the detergent drawer for more than 2 days (Fabric softener may harden).
- Softener will automatically be added during the last rinse cycle.
- Do not open the drawer when water is being supplied.
- Solvents (benzene, etc.) must not be used.

**NOTE**

- Do not pour fabric softener directly on the clothes.

### Adding Water Softener

- A water softener, such as anti-limescale (e.g. Calgon) can be used to cut down on the use of detergent in extremely hard water areas. Dispense according to the amount specified on the packaging. First add detergent and then the water softener.
- Use the quantity of detergent required for soft water.

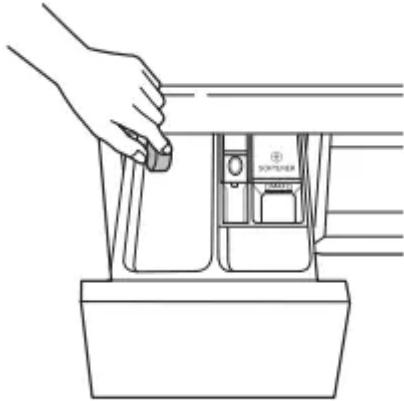

### **Using Tablet**

- 1 Open the door and put tablets into the drum.

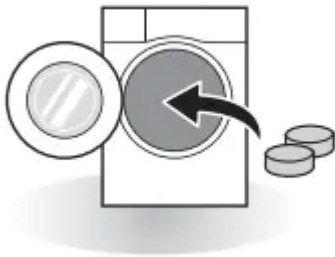

- 2 Load the laundry into the drum and close the door.

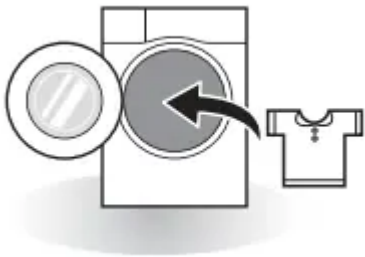

## Control Panel

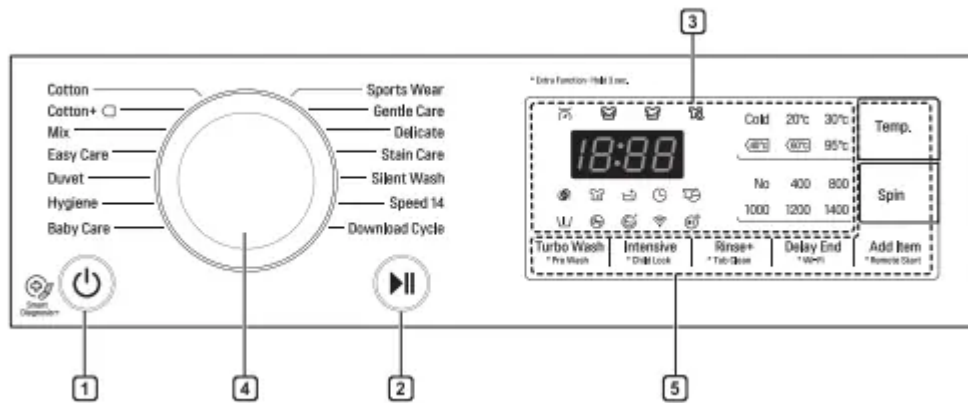

### 1. Power Button

- Press the Power button to turn the washing machine on.

### 2. Start/Pause Button

- This Start/Pause button is used to start the wash cycle or pause the wash cycle.
- If a temporary stop of the wash cycle is needed, press the Start/Pause button.

### 3. Display

- The display shows the settings, estimated time remaining, options, and status messages. When the product is turned on, the default settings in the display will illuminate.
- The display shows estimate time remaining. While the size of the load is being calculated automatically, blinking or 'Detecting' appears.
- The RPM may differ depending on the models.

### 4. Programme Knob

- Programmes are available according to the laundry type.
- The lamp will light up to indicate the selected programme.

### 5. Options

- This allows you to select an additional programme and will light when selected.
- Use these buttons to select the desired programme options for the selected cycle.
- In order to use the Remote Start function, refer to SMART FUNCTIONS.

## Programme Table

### Washing Programme

### Programme Description Fabric Type Proper Temp. Maximum Load

<b>Cotton</b>	Provides better performance by combining various drum motions.	Coloured fast garments (shirts, nightdresses, pajamas, etc.) and normally soiled cotton load (underwear).	40 °C (Cold to 95 °C)	Rating
<b>Cotton+</b>	Provides optimised washing performance for large amount of laundry with less energy consumption.		60 °C (Cold to 60 °C)	
<b>Easy Care</b>	Suitable for casual shirts that do not need ironing after washing.	Polyamide, acrylic, polyester.	40 °C (Cold to 60 °C)	4.0 kg
<b>Mix</b>	Enables various fabrics to be washed simultaneously.	Various kind of fabrics except special garments (silk/delicate, sports wear, dark clothes, wool, duvet/curtains).	40 °C (Cold to 40 °C)	
<b>Hygiene</b>	Washes laundry in a hot cycle	cotton, underwear, pillow covers, bed sheets, baby wear	60 °C	
<b>Duvet</b>	For large items such as bed covers, pillows, sofa covers, etc.	Cotton bedding except special garments (delicates, wool, silk, etc.) with filling: duvets, pillows, blankets, sofa covers with light filling	Cold (Cold to 40 °C)	
<b>Sports Wear</b>	Suitable for sports wear such as jogging clothes and running wear.	Coolmax, gore-tex, fleece and sympatex	40 °C (Cold to 40 °C)	2.0 kg

**Programme Description Fabric Type Proper Temp. Maximum Load**

<b>Baby Care</b>	Removes solid and protein stains, provides better rinse performance.	Lightly soiled baby wear.	60 °C	5.0 kg
<b>Silent Wash</b>	Provides less noise and vibration and saves money by using overnight electricity.	Coloured fast garments (shirts, nightdresses, pajamas, etc.) and lightly soiled white cotton (underwear).	40 °C (Cold to 60 °C)	5.0 kg
<b>Delicate</b>	For delicate clothes such as underwear, blouses, etc.	Delicate, easily damaged laundry.	20 °C (Cold to 40 °C)	3.0 kg
<b>Speed 14</b>	This cycle provides fast washing time for small loads and lightly soiled clothes.	Coloured laundry which is lightly soiled fast. CAUTION : Use less than 20g of detergent (for 2.0kg load) otherwise detergent may remain on the clothes.	20 °C (20 °C to 40 °C)	2.0 kg
<b>Gentle Care</b>	For hand and machine washable delicate clothes such as washable wool, lingerie, dresses etc. (Use detergent for machine washable wools).	Wool, hand washable clothes, delicate, easily damaged laundry.	20 °C (Cold to 30 °C)	1.5 kg
<b>Stain Care</b>	Wash off several kinds of stain such as wine, juice, dirt, etc. (Water temperature is increased step by step for washing various stains).	Cotton blended fabrics, no delicate clothes.	60 °C (30 °C to 60 °C)	3.0 kg
<b>Download Cycle</b>	For downloadable programmes. If you did not download any programmes, the default is Rinse+Spin.			

- Water Temperature: Select the appropriate water temperature for chosen wash programme. Always follow garment manufacturer's care label or instructions when washing.
- Set program at "Cotton+, 40 °C (Half Load)", "Cotton+ 60 °C (Half Load)", "Cotton+ 60 °C (Full Load)" option for test in conformity with EN60456 and Regulation 1015/2010.

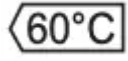
–Standard 60 °C cotton program : Cotton+  +  (Full Load)

–Standard 60 °C cotton program : Cotton+  +  (Half Load)

–Standard 40 °C cotton program : Cotton+  + 40°C (Half Load)

(They are suitable to clean normally soiled cotton laundry.)

(They are the most efficient programmes in terms of combined energy and water consumptions for washing that type of cotton laundry.)

- Actual water temperature may differ from the declared cycle temperature.
- The test results depend on water pressure, water hardness, water inlet temperature, room temperature, type and amount of load, degree of soiling utilized detergent, fluctuations in the main electricity supply and chosen additional options.

**NOTE**

- Neutral detergent is recommended

**Extra Options**

**Programme Turbo Wash Intensive Rinse+ Delay End Pre Wash**

<b>Cotton</b>	•	•	•	•	•
<b>Cotton+</b>	•		•	•	•
<b>Mix</b>	•	•	•	•	•
<b>Easy Care</b>	•	•	•	•	•
<b>Duvet</b>		•	•	•	
<b>Hygiene</b>		•	•	•	
<b>Baby Care</b>		•	•	•	
<b>Sports Wear</b>		•	•	•	
<b>Gentle Care</b>			•	•	
<b>Delicate</b>		•	•	•	
<b>Stain Care</b>			•	•	•*
<b>Silent Wash</b>		•	•	•	
<b>Speed 14</b>	•*		•	•	

- \* : This option is automatically included in the cycle and can not be deleted.

**Operating Data**



Programme	Max RPM
	F4J**** FH4U2JCN2 FH4U2JCN8
Cotton	1400
Cotton+	1400
Mix	1400
Easy Care	1000
Duvet	1000
Hygiene	1400
Baby Care	1000
Sports Wear	800
Gentle Care	800
Delicate	800
Stain Care	1400
Silent Wash	1000
Speed 14	800

Programme	Time in Minutes	Remaining moisture content	Water in Litre	Energy in kWh
	10 kg	1400 rpm	10 kg	10 kg
	1400 rpm			
Cotton (40 °C)	96	40 %	66	0.72
Cotton+ (60 °C)	270	44 %	37	0.63

## Option Programme

### Delay End

You can set a time delay so that the washing machine will start automatically and finish after a specified time interval.

- 1 Press the Power button.
- 2 Select a washing programme.
- 3 Press the Delay End button to set time required.
- 4 Press the Start/Pause button.

### NOTE

- The delay time is the time to the end of the programme, not the start. The actual running time may vary due to water temperature, wash load and other factors.
- To cancel the function, the power button should be pressed.
- Avoid using liquid detergent for this option.

## Pre Wash

If the laundry is heavily soiled, the Pre Wash programme is recommended.

- 1 Press the Power button.
- 2 Select a washing programme.
- 3 Press the Pre Wash button for three seconds.
- 4 Press the Start/Pause button.

## Intensive

If the laundry is normal and heavily soiled, Intensive option is effective.

- 1 Press the Power button.
- 2 Select a washing programme.
- 3 Press the Intensive button.
- 4 Press the Start/Pause button.

## Wi-Fi

When Wi-Fi is connected, the Wi-Fi icon on the control panel is lit.

## Turbo Wash

Wash cycle in under 1 hour with energy and water saving. (based on half of laundry)

- 1 Press the Power button.
- 2 Select a washing programme.
- 3 Press the Turbo Wash button.
- 4 Press the Start/Pause button.

## Temp.

The Temp. button selects the wash and rinse temperature combination for the selected programme. Press this button until the desired setting is lit. All rinses use cold tap water.

- Select the water temperature suitable for the type of load you are washing. Follow the garment fabric care labels for best results.

## Spin

- Spin speed level can be selected by pressing the Spin button repeatedly.
- Spin Only
  - 1 Press the Power button.
  - 2 Press the Spin button to select RPM.

- 3 Press the Start/Pause button.

## NOTE

- When you select No, it will still rotate for a short time to drain quickly.

## Rinse

Rinse+ 

Add rinse once.

Add Item 

Laundry can be added or removed after the washing programme is started.

- 1 Press the Add Item button when the LED is turned on.
- 2 Add or remove laundry.
- 3 Close the door and Press the Start/Pause button.

## NOTE

- For safety reasons, the door remains locked when the water level or temperature is high. It is not possible to add laundry during this time.
- If the water temperature in the drum is high, wait until it cools down.



## CAUTION

- When adding laundry, make sure to completely push it into the drum. If laundry gets stuck in the door latch hole, the rubber packing may be damaged, causing water leakage and malfunction.
- Forcing the door open may cause part damage, destruction, or safety problems.
- If you open the door while there are a lot of suds and water in the drum, the suds or water may flow, causing burn injury or wet floor.

## Child Lock

Use this option to disable the controls. This feature can prevent children from changing cycles or operating the appliance

### Locking the Control Panel

- 1 Press and hold the Child Lock button for three seconds.
- 2 A beeper will sound, and will appear on the display. When the Child Lock is set, all buttons are locked except the Power button.

## NOTE

- Turning off the power will not reset the child lock function. You must deactivate child lock before you can access any other functions.

### Unlocking the Control Panel

Press and hold the Child Lock button for three seconds.

- A beeper will sound and the remaining time for the current programme will reappear on the display.

### Beep On / Off

- 1 Press the Power button.
- 2 Press the Start/Pause button.
- 3 Press and hold the Temp. and Spin button simultaneously for 3 seconds to set the Beep on/off function.

## NOTE

- Once the Beep on/off function is set, the setting is memorized even after the power is turned off.
- If you want to turn the Beeper off, simply repeat this process.

## MAINTENANCE



### WARNING

- Unplug the washing machine before cleaning to avoid the risk of electric shock. Failure to follow this warning may result in serious injury, fire, electric shock, or death.
- Never use harsh chemicals, abrasive cleaners, or solvents to clean the washing machine. They may damage the finish.

### Cleaning Your Washing Machine

#### Care After Wash

- After the cycle is finished, wipe the door and the inside of the door seal to remove any moisture.
- Leave the door open to dry the drum interior.
- Wipe the body of the washing machine with a dry cloth to remove any moisture.



## **Cleaning the Exterior**

Proper care of your washing machine can extend its life.

### Door:

- Wash with a damp cloth on the outside and inside and then dry with a soft cloth.

### Exterior:

- Immediately wipe off any spills.
- Wipe with a damp cloth.
- Do not press the surface or the display with sharp objects.

## **Cleaning the Interior**

- Use a towel or soft cloth to wipe around the washing machine door opening and door glass.
- Always remove items from the washing machine as soon as the cycle is complete. Leaving damp items in the washing machine can cause wrinkling, colour transfer, and odour.
- Run the Tub Clean programme once a month (or more often if needed) to remove detergent buildup and other residue

## **Cleaning the Water Inlet Filter**

- Turn off the supply taps to the machine if the washing machine is to be left for any length of time (e.g. holiday), especially if there is no floor drain (gully) in the immediate vicinity.
- icon will be displayed on the control panel when water is not entering the detergent drawer.
- If water is very hard or contains traces of lime deposit, the water inlet filter may become clogged. It is therefore a good idea to clean it occasionally.
  - 1 Turn off the water tap and unscrew the water supply hose.



- 2 Clean the filter using a hard bristle brush.

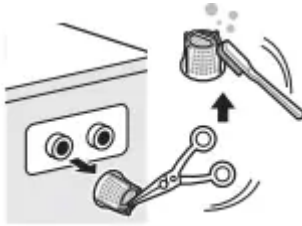

### Cleaning the Drain Pump Filter

- The drain filter collects threads and small objects left in the laundry. Check regularly that the filter is clean to ensure smooth running of your washing machine.
- Allow the water to cool down before cleaning the drain pump, carrying out emergency emptying, or opening the door in an emergency.

- 1 Open the cover cap and pull out the hose.

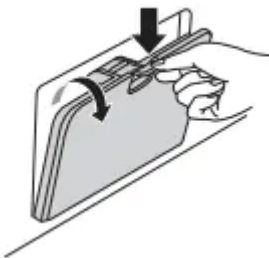

- 2 Unplug the drain plug and open the filter by turning it to the left.

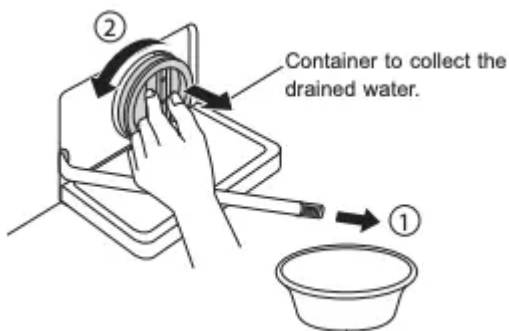

- 3 Remove any extraneous matter from the pump filter.

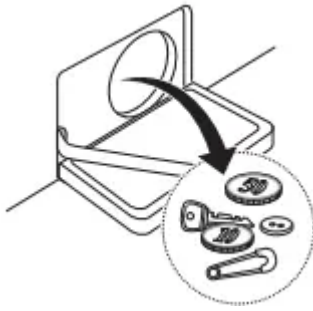

- 4 After cleaning, turn the pump filter and insert the drain plug.

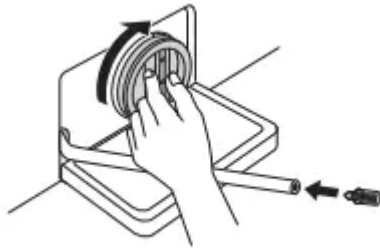

- 5 Close the cover cap.

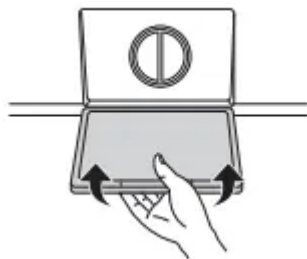

**! CAUTION**

- First drain using the drain hose and then open the pump filter to remove any threads or objects.
- Be careful when draining, as the water may be hot.

### **Cleaning the Dispenser Drawer**

Detergent and fabric softener may build up in the dispenser drawer. Remove the drawer and inserts and check for buildup once or twice a month.

- 1 Remove the detergent dispenser drawer by pulling it straight out until it stops.

- Press down hard on the disengage button and remove the drawer.

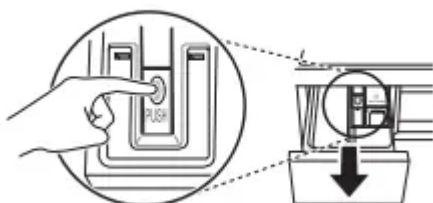

2 Remove the inserts from the drawer.

- Rinse the inserts and the drawer with warm water to remove buildup from laundry products. Use only water to clean the dispenser drawer. Dry the inserts and drawer with a soft cloth or towel.

3 To clean the drawer opening, use a cloth or small, non-metal brush to clean the recess.

- Remove all residue from the upper and lower parts of the recess.

4 Wipe any moisture off the recess with a soft cloth or towel.

5 Return the inserts to the proper compartments and replace the drawer.

### Tub Clean (Optional)

Tub Clean is a special programme to clean the inside of the washing machine. A higher water level is used in this programme at higher spin speed. Perform this programme regularly.

1 Remove any clothing or items from the washing machine and close the door.

2 Open the dispenser drawer and add anti-limescale (e.g. Calgon) to the main wash compartment.

- For tablets put into the drum.

3 Close the dispenser drawer slowly.

4 Power on and then press and hold Tub Clean button for 3 seconds. Then  will be displayed on the display.

5 Press the Start/Pause button to start.

6 After the programme is complete, leave the door open to allow the washing machine door opening, flexible gasket and door glass to dry.



- If there is a child, be careful not to leave the door open for too long.

### NOTE

- Do not add any detergent to the detergent compartments. Excessive suds may generate and leak from the washing machine.

## TROUBLESHOOTING

- Your washing machine is equipped with an automatic error-monitoring system to detect and diagnose problems at an early stage. If your washing machine does not function properly or does not function at all, check the following before you call for service:

## Diagnosing Problems

### Symptoms Rattling and clanking noise

**Reason** Foreign objects such as coins or safety pins may be in drum or pump.

#### **Solution**

- Check all pockets to make sure that they are empty. Items such as clips, matches, pens, coins, and keys can damage both your washer and your clothes.
- Close zippers, hooks, and drawstrings to prevent these items from snagging or tangling on other clothes.

### Symptoms Thumping sound

**Reason** Heavy wash loads may produce a thumping sound. This is usually normal.

**Solution** If sound continues, washing machine is probably out of balance. Stop and redistribute wash load.

### Symptoms Vibrating noise

#### **Reason**

- Have all the transit bolts and tub support been removed?
- Are all the feet resting firmly on the ground?

#### **Solution**

- If not removed during installation, refer to Installation guide for removing transit bolts.
- Make sure the washing machine is level and tighten the lock nuts up towards the base of the appliance.

### Symptoms Water leaks

#### **Reason**

- Supply hoses or drain hose are loose at tap or washing machine.
- House drain pipes are clogged.

#### **Solution**

- Check and tighten hose connections.
- Unclog drain pipe. Contact plumber if necessary

### Symptoms Oversudsing

**Reason** Too much detergent or unsuitable detergent may cause excessive foaming which may result in water leaks.

**Solution** Make sure that the suggested amount of detergent is used per the manufacturer's recommendations.

**Symptoms** Water does not enter washing machine or it enters slowly

**Reason**

- Water supply is not adequate in that location.
- Water supply tap is not completely open.
- Water supply hose(s) are kinked.
- The filter of the supply hose(s) clogged.

**Solution**

- Check another tap in the house.
- Fully open tap.
- Straighten hose.
- Check the filter of the supply hose

**Symptoms** Water in the washing machine does not drain or drains slowly

**Reason**

- Drain hose is kinked or clogged.
- The drain filter is clogged.

**Solution**

- Clean and straighten the drain hose.
- Clean the drain filter.

**Symptoms** Washing machine does not start

**Reason**

- Electrical power cord may not be plugged in or connection may be loose
- House fuse blown, circuit breaker tripped, or a power outage has occurred.
- Water supply tap is not turned on.

**Solution**

- Make sure plug fits tightly in wall outlet.
- Reset circuit breaker or replace fuse. Do not increase fuse capacity. If problem is a circuit overload, have it corrected by a qualified electrician.
- Turn on water supply tap.

**Symptoms** Washing machine will not spin

**Reason** Check that the door is firmly shut

**Solution** Close the door and press the Start/ Pause button. After pressing the Start/Pause button, it may take a few moments before the washing machine begins to spin. The door must be locked

before spin can be achieved. Add 1 or 2 similar items to help balance the load. Rearrange load to allow proper spinning.

**Symptoms** Door does not open

**Reason** Once washing machine has started, the door cannot be opened for safety reasons.

**Solution** Check if the 'Door Lock' icon is illuminated. You can safely open the door after the 'Door Lock' icon turns off.

**Symptoms** Wash cycle time delayed

**Reason** If an imbalance is detected or if the suds removing programme is on, the wash time will increase

**Solution** This is normal. The time remaining shown in the display is only an estimate. Actual time may vary.

**Symptoms** Fabric softener overflow

**Reason** Too much softener may cause an overflow.

**Solution** Follow softener guidelines to ensure appropriate amount is used. Do not exceed the maximum fill line.

**Symptoms** Softeners dispensed too early

**Reason** Too much softener may cause an premature dispensing.

**Solution**

- Follow the guidelines provided by the detergent manufacturer.
- Close the dispenser drawer slowly. Do not open the drawer during the wash cycle.

**Symptoms** The buttons may not function properly.

**Reason** The button cannot be recognized when the door is open.

**Solution** Press again after closing the door.

**Symptoms** Dry problem

**Reason** Check water supply tap

**Solution**

- Do not overload. Check that the washing machine is draining properly to extract adequate water from the load. Clothes load is too small to tumble properly. Add a few towels.
- Turn off water supply tap.

**Symptoms** Odor

**Reason**

- This odor is caused by the rubber attached to the washing machine.

- If the rubber door gasket and door seal area are not cleaned regularly, odors can occur from mold or foreign substances.
- Odors can occur if foreign substances are left in the drainage pump filter.
- Odors can occur if the drainage hose is not properly installed, causing siphoning (water flowing back inside the washing machine).
- Using the dry function, odors can occur from lint and other laundry matter sticking to the heater. (Dryer model only)
- A particular odor can occur from drying wet clothes with hot air. | (Dryer model only)

### **Solution**

- + It is the normal odor of new rubber and will disappear after the machine has been run a few times. e Be sure to clean the gasket and door seal regularly and check under the door seal for small items when unloading the washer.
- + Be sure to clean the drainage pump filter regularly. e When installing the drainage hose, be sure that it doesn't become kinked or blocked.
- + This is not a malfunction.
- + The odor will disappear after a short while.

**Symptoms** Your home appliance and smartphone is not connected to the Wi-Fi network.

### **Reason**

- The password for the Wi-Fi network you are trying to connect to is incorrect.
- Mobile data for your smartphone is turned on.
- The wireless network name (SSID) is set incorrectly.
- The router frequency is not 2.4 GHz.
- The distance between the appliance and the router is too far.

### **Solution**

- + Find the Wi-Fi network connected to your smartphone and remove it. Then register your appliance on LG SmartThinQ. e Turn off the Mobile data of your smartphone and register the appliance using the Wi-Fi network.
- + The wireless network name (SSID) should be a combination of English letters and numbers. (Do not use special characters.) Only a 2.4 GHz router frequency is supported. Set the wireless router to 2.4 GHz and connect the appliance to the wireless router. To check the router frequency, check with your Internet service provider or the router manufacturer.

+ If the distance between the appliance and the router is too far. the signal may be weak and the connection may not be configured correctly. Move the location of the router so that it is closer to the appliance.

## Error Messages



### Symptoms

### Reason

- Water supply is not adequate in area.
- Water supply taps are not completely open.
- Water supply hose(s) are kinked.
- The filter of the supply hose(s) are clogged.
- If water leakage occurred in the aqua stop supply hose, indicator **A** will become red.



May vary depending on the model.

### Solution

- Check another tap in the house.
- Fully open tap.
- Straighten hose(s).
- Check the filter of the supply hose.
- Use the aqua stop supply hose.



### Symptoms

## Reason

- Load is too small.
- Load is out of balance.
- The appliance has an imbalance detection and correction system. If individual heavy articles are loaded (e.g. bath mat, bath robe, etc.) this system may stop spinning or even interrupt the spin cycle altogether.
- If the laundry is still too wet at the end of the cycle, add smaller articles of laundry to balance the load and repeat | the spin cycle.

## Solution

- Add 1 or 2 similar items to help balance the load.
- Add 1 or 2 similar items to help balance the load.
- Rearrange load to allow proper spinning.
- Rearrange load to allow proper spinning.



## Symptoms

## Reason

- Drain hose is kinked or clogged.
- The drain filter is clogged.

## Solution

- Clean and straighten the drain hose.
- Clean the drain filter.



## Symptoms

**Reason** Ensure door is not open.

**Solution** Close the door completely. If *dE, dE 1, dE2, dE4* is not released, call for service.



**Reason** Door sensor has malfunctioned.

**Solution** Close the door completely. If *dE, dE 1, dE2, dE4* is not released, call for service.

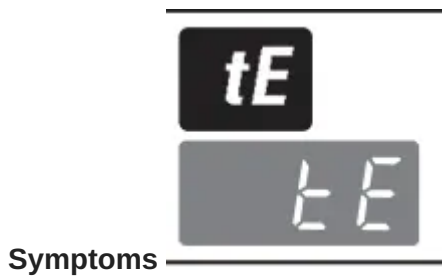

**Reason** Control error

**Solution** Unplug the power plug and call for service.

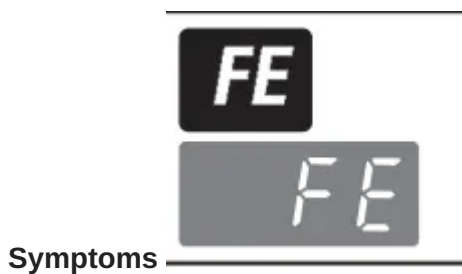

**Reason** Water overfills due to the faulty water valve.

**Solution**

- Close the water tap.
- Unplug the power plug.
- Call for service.

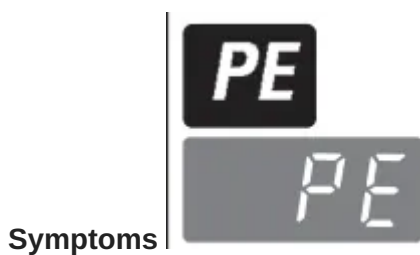

**Reason** Malfunction of water level sensor.

**Solution**

- Close the water tap.
- Unplug the power plug.
- Call for service.



**Symptoms**

**Reason** Over load in motor.

**Solution** Allow the washing machine to stand for 30 minutes to allow the motor to cool, then restart the cycle.



**Symptoms**

**Reason** Is supply/drain hose or drain pump frozen?

**Solution** Supply warm water into the drum and unfreeze drain hose and drain pump. Wet a towel in warm water and apply to supply hose.

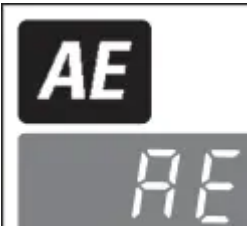

**Symptoms**

**Reason** Water leaks.

**Solution** • Call for service.



**Symptoms**

**Reason** Does not dry

**Solution** Call for service.



**Warning**

This content is compiled from multiple sources and is provided for reference purposes only. It may not be complete or fully applicable to all situations. If you are unable to resolve your issue, please contact the product manufacturer or an authorized service provider for official support.

---

Document generated by [ManualsFile](#)