

PARTS

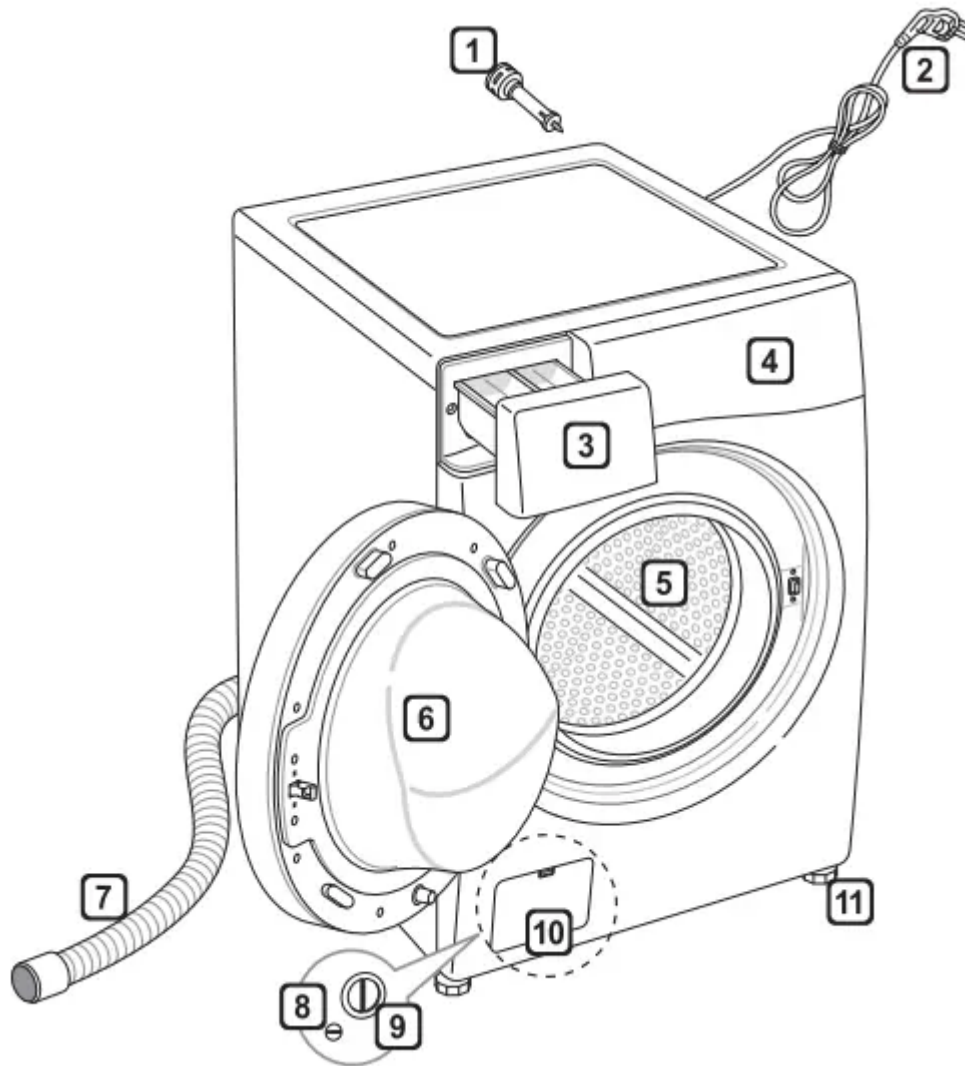

1. Transit bolts
2. Power plug
3. Drawer
4. Control panel
5. Drum
6. Door
7. Drain hose
8. Drain plug
9. Drain pump filter
10. Cover cap (Location may vary depending on products)

SPECIFICATION

Model	F*J*VN(P)(0~9)* FH4U2VCN2 FH4U2VCN8	F*J*TN(P)(0~9)* FH4U2TDN(P)(0~9)*
Wash Capacity	9 kg	8 kg
Power Supply	220 - 240 V~, 50 Hz	
Size	600 mm (W) x 560 mm (D) x 850 mm (H)	
Product Weight	62 kg	
Permissible Water pressure	0.1 - 1.0 MPa (1.0 - 10.0 kgf / cm ²)	

OPERATION

Before the first wash, select a washing program, and allow the washing machine to wash without clothing. This will remove residue and water from the drum that may have been left during manufacturing.

1. Sort laundry and load items.

- Sort laundry by fabric type, soil level, color and load size as needed. Open the door and load items into the washing machine.
- Sort laundry by fabric type, soil level, color and load size as needed. Open the door and load items into the washing machine.

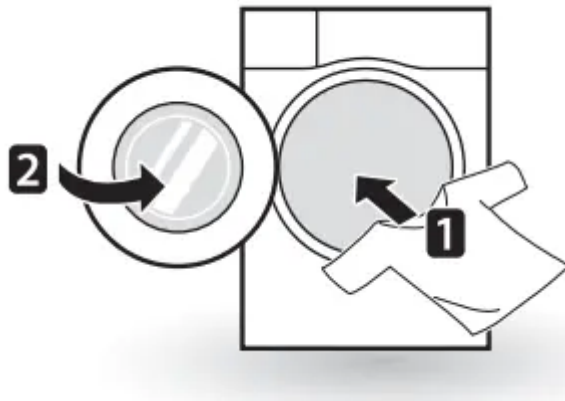

2. Add cleaning products and/or detergent and softener.

- Add the proper amount of detergent with the detergent measuring cup to the washing drum evenly.
- Add the proper amount of detergent to the detergent dispenser drawer. If desired, add bleach or fabric softener to the appropriate areas of the dispenser.

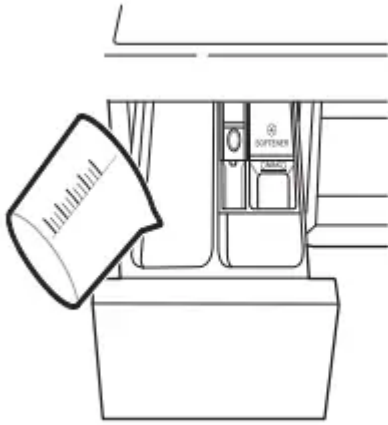

3. Turn on the washing machine.

- Press the Power button to turn on the washing machine.

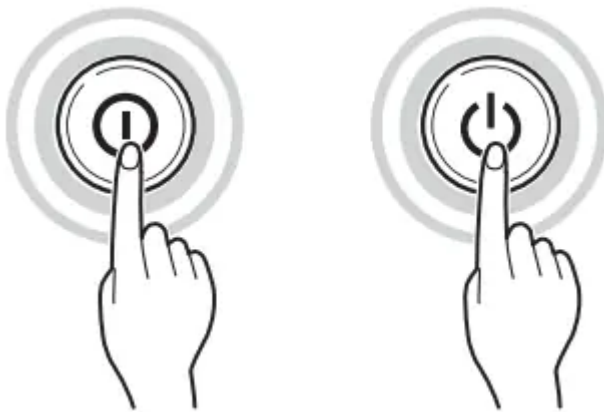

4. Choose the desired washing cycle.

- Press the program button repeatedly or turn the cycle selector knob until the desired cycle is selected.
- Press the cycle button repeatedly until the desired cycle is selected.
- Press the cycle button repeatedly or turn the cycle selector knob until the desired cycle is selected

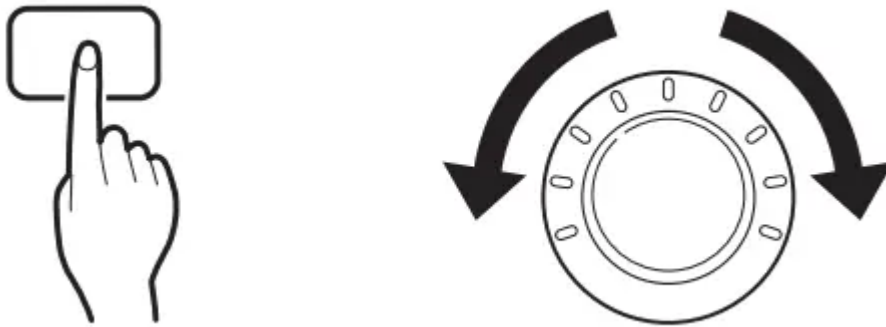

5. Begin cycle.

- Press the Start/Pause button to begin the cycle. The washing machine will agitate briefly without water to measure the weight of the load. If the Start/Pause button is not pressed within 5 minutes, the washing machine will shut off and all settings will be lost.



6. End of cycle.

- When the cycle is finished, a melody will sound. Immediately remove your clothing from the washing machine to reduce wrinkling. Check around the door seal when removing the load for small items that may be caught in the seal.

Sorting Laundry

1. Look for a care label on your clothes.

- This will tell you about the fabric content of your garment and how it should be washed.
- Symbols on the care labels.



Wash temperature

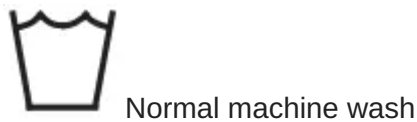

2. Sorting laundry.

- To get the best results, sort clothes into loads that can be washed with the same wash cycle.
- Different fabrics need to be washed at varying temperatures and spin speeds.
- Always sort dark colors from pale colors and whites. Wash separately as dye and lint transfer can occur causing discoloration of white and pale garments. If possible, do not wash heavily soiled items with lightly soiled ones.
 - Soil (Heavy, Normal, Light) : Separate clothes according to amount of soil.
 - Colour (White, Lights, Darks): Separate white fabrics from colored fabrics.
 - Lint (Lint producers, Collectors): Wash lint producers and lint collectors separately

3. Caring before loading.

- Combine large and small items in a load. Load large items first.
- Large items should not be more than half the total wash load. Do not wash single items. This may cause an unbalanced load. Add one or two similar items.
- Check all pockets to make sure that they are empty. Items such as nails, hair clips, matches, pens, coins and keys can damage both your washing machine

and your clothes.

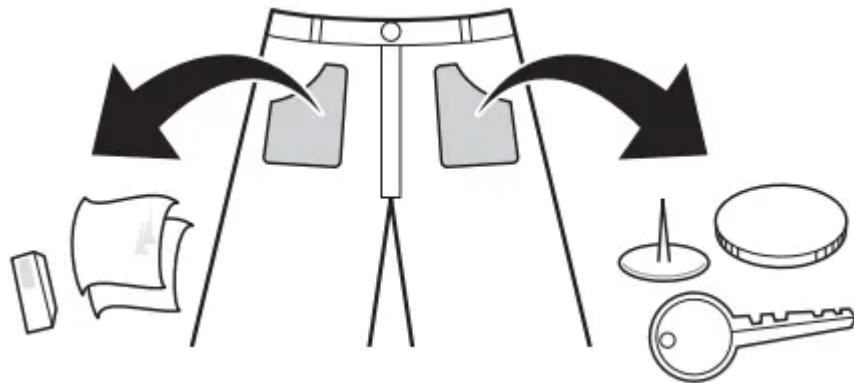

- Close zippers, hooks and strings to make sure that these items don't snag on other clothes.
- Pre-treat dirt and stains by brushing a small amount of detergent-dissolved water onto stains to help lift dirt.
- Check the folds of the flexible gasket (gray) and remove any small articles.
- Check inside the drum and remove any items from a previous wash.

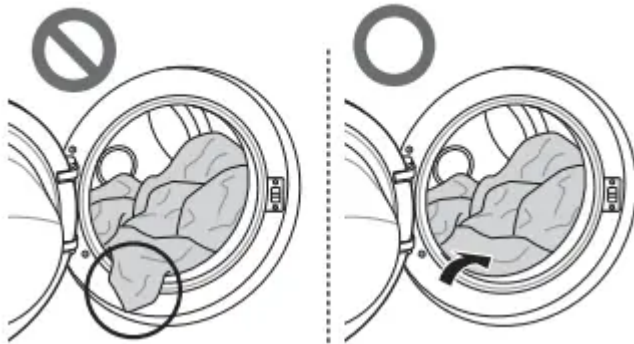

- Remove any clothing or items from the flexible gasket to prevent clothing and gasket damage.

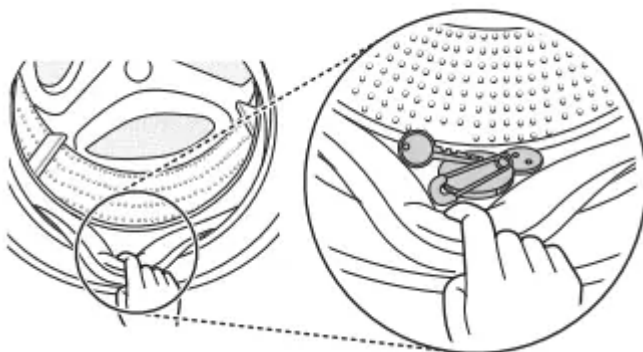



Adding Cleaning Products

Detergent Dosage

- Detergent should be used according to the instruction of the detergent manufacturer and selected according to type, colour, soiling of the fabric and washing temperature.
- If too much detergent is used, too many suds can occur and this will result in poor washing results or cause heavy load to the motor.
- If you wish to use liquid detergent follow the guidelines provided by the detergent manufacturer.
- You can pour liquid detergent directly into the main detergent drawer if you are starting the cycle immediately.
- Do not use liquid detergent if you are using Time delay, or if you have selected Pre Wash, as the liquid may harden.
- If too many suds occur, reduce the detergent amount.
- Detergent usage may need to be adjusted for water temperature, water hardness, size and soil level of the load. For best results, avoid oversudsing.
- Refer to the label of the clothes, before choosing the detergent and water temperature.
- When using the washing machine, use designated detergent for each type of clothing only:
 - General powdered detergents for all types of fabric
 - Powdered detergents for delicate fabric
 - Liquid detergents for all types of fabric or designated detergents only for wool
- For better washing performance and whitening, use detergent with the general powdered bleach.
- Detergent is flushed from the dispenser at the beginning of the cycle.

Adding Detergent and Fabric Softener

Adding Detergent

- Main wash only → 
- Pre wash+Main wash →  • 

Adding Fabric Softener

- Do not exceed the maximum fill line. Overfilling can cause early dispensing of the fabric softener, which may stain clothes. Close the dispenser drawer slowly.

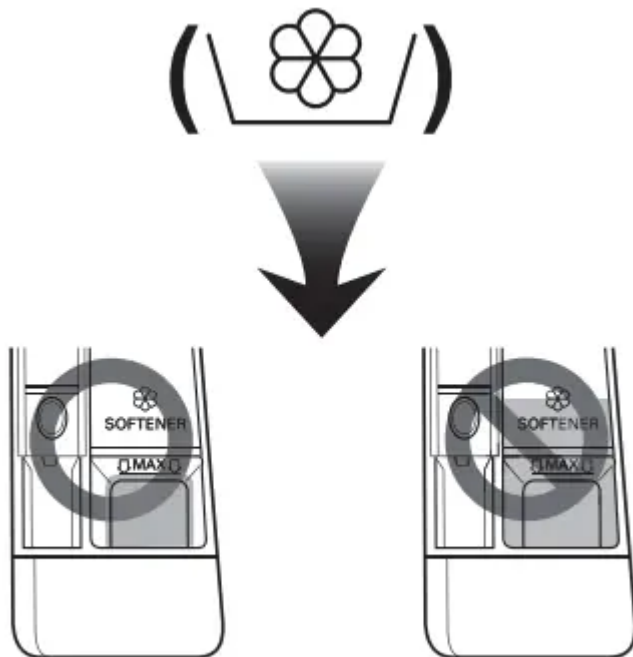

- Do not leave the fabric softener in the detergent drawer for more than 2 days (Fabric softener may harden).
- Softener will automatically be added during the last rinse cycle.
- Do not open the drawer when water is being supplied.
- Solvents (benzene, etc.) must not be used

Adding Water Softener

- A water softener, such as anti-limescale (e.g. Calgon) can be used to cut down on the use of detergent in extremely hard water areas. Dispense according to the amount specified on the packaging. First add detergent and then the water softener.
- Use the quantity of detergent required for soft water.

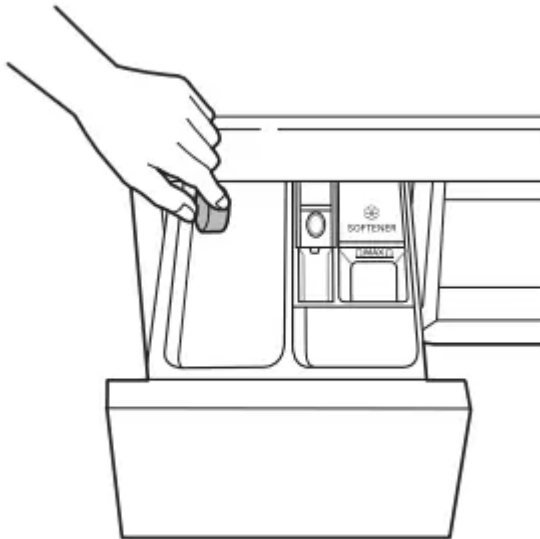

Using Tablet

1. Open the door and put tablets into the drum.

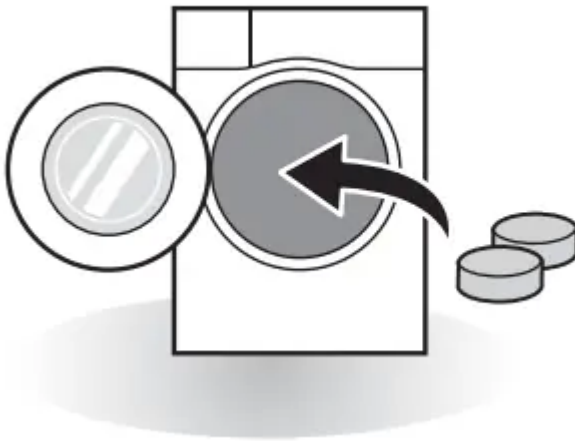

2. Load the laundry into the drum and close the door.

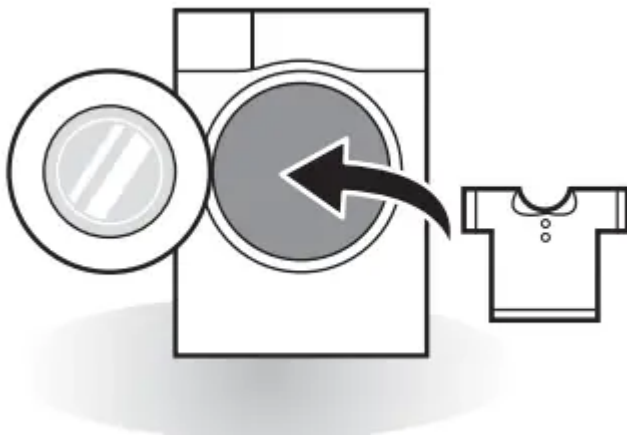

Control Panel

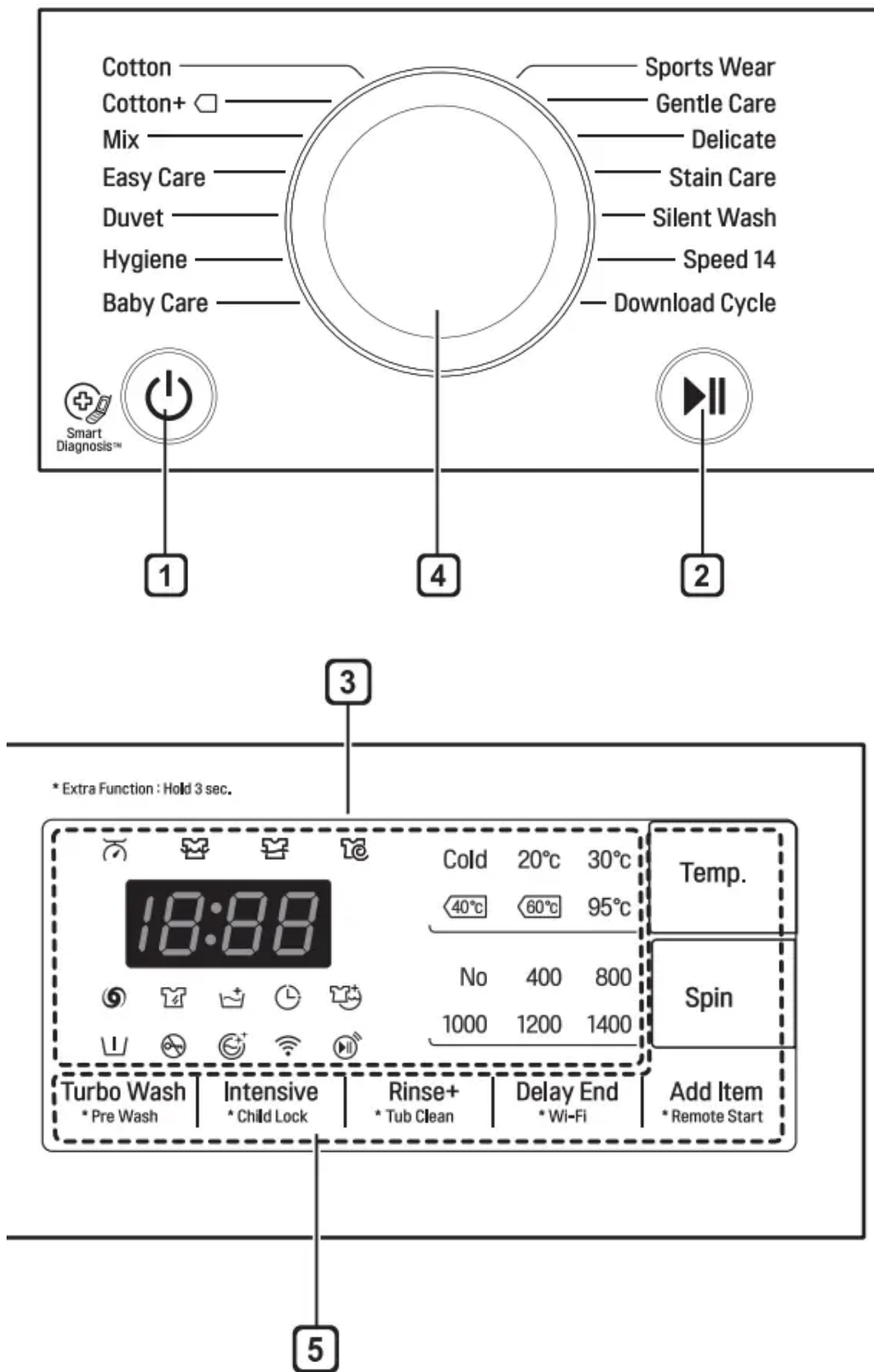

1. Power Button

- Press the Power button to turn the washing machine on.

2. Start/Pause Button

- This Start/Pause button is used to start the wash cycle or pause the wash cycle.
- If a temporary stop of the wash cycle is needed, press the Start/Pause button.

3. Display

- The display shows the settings, estimated time remaining, options, and status messages. When the product is turned on, the default settings in the display will illuminate.

- The display shows estimated time remaining. While the size of the load is

being calculated automatically, blinking  or 'Detecting' appears.

- The RPM may differ depending on the models.

4. Programme Knob

- Programmes are available according to the laundry type.
- The lamp will light up to indicate the selected program.

5. Options

- This allows you to select an additional program and will light when selected.
- Use these buttons to select the desired program options for the selected cycle.
- In order to use the Remote Start function, refer to SMART FUNCTIONS.

Programme Table

Washing Programme

Programme	Description	Fabric Type	Proper Temp.	Maximum Load
Cotton	Provides better performance by combining various drum motions.	Coloured fast garments (shirts, nightdresses, pajamas, etc.) and normally soiled cotton load (underwear).	40 °C (Cold to 95 °C)	Rating
Cotton+	Provides optimised washing performance for large amount of laundry with less energy consumption.		60 °C (Cold to 60 °C)	
Easy Care	Suitable for casual shirts that do not need ironing after washing.	Polyamide, acrylic, polyester.	40 °C (Cold to 60 °C)	4.0 kg
Mix	Enables various fabrics to be washed simultaneously.	Various kind of fabrics except special garments (silk/delicate, sports wear, dark clothes, wool, duvet/curtains).	40 °C (Cold to 40 °C)	
Hygiene	Washes laundry in a hot cycle	cotton, underwear, pillow covers, bed sheets, baby wear	60 °C	

Duvet	For large items such as bed covers, pillows, sofa covers, etc.	Cotton bedding except special garments (delicates, wool, silk, etc.) with filling: duvets, pillows, blankets, sofa covers with light filling	Cold (Cold to 40 °C)	1 single size
Sports Wear	Suitable for sports wear such as jogging clothes and running wear.	Coolmax, gore-tex, fleece and sympatex	40 °C (Cold to 40 °C)	2.0 kg

Baby Care	Removes solid and protein stains, provides better rinse performance.	Lightly soiled baby wear.	60 °C	4.0 kg
Silent Wash	Provides less noise and vibration and saves money by using overnight electricity.	Coloured fast garments (shirts, nightdresses, pajamas, etc.) and lightly soiled white cotton (underwear).	40 °C (Cold to 60 °C)	4.5 kg
Delicate	For delicate clothes such as underwear, blouses, etc.	Delicate, easily damaged laundry.	20 °C (Cold to 40 °C)	1.5 kg
Speed 14	This cycle provides fast washing time for small loads and lightly soiled clothes.	Coloured laundry which is lightly soiled fast. CAUTION : Use less than 20g of detergent (for 2.0kg load) otherwise detergent may remain on the clothes.	20 °C (20 °C to 40 °C)	2.0 kg

Gentle Care	For hand and machine washable delicate clothes such as washable wool, lingerie, dresses etc. (Use detergent for machine washable woolens).	Wool, hand washable clothes, delicate, easily damaged laundry.	20 °C (Cold to 30 °C)	1.5 kg
Stain Care	Wash off several kinds of stain such as wine, juice, dirt, etc. (Water temperature is increased step by step for washing various stains).	Cotton blended fabrics, no delicate clothes.	60 °C (30 °C to 60 °C)	3.0 kg
Download Cycle	For downloadable programmes. If you did not download any programmes, the default is Rinse+Spin.			

- Water Temperature: Select the appropriate water temperature for chosen wash programme. Always follow garment manufacturer's care label or instructions when washing.
- Set program at "Cotton+, 40 °C (Half Load)", "Cotton+ 60 °C (Half Load)", "Cotton+ 60 °C (Full Load)" option for test in conformity with EN60456 and Regulation 1015/2010.

–Standard 60 °C cotton program : Cotton+ + 60°C (Full Load)

–Standard 60 °C cotton program : Cotton+  + 60°C (Half Load)

–Standard 40 °C cotton program : Cotton+  + 40°C (Half Load) (They are suitable to clean normally soiled cotton laundry.) (They are the most efficient programs in terms of combined energy and water consumption for washing that type of cotton laundry.)

- Actual water temperature may differ from the declared cycle temperature.
- The test results depend on water pressure, water hardness, water inlet temperature, room temperature, type and amount of load, degree of soiling utilized detergent, fluctuations in the main electricity supply and chosen additional options.

Extra Options

Programme	Turbo Wash	Intensive	Rinse+	Delay End	Pre Wash
Cotton	•	•	•	•	•
Cotton+	•		•	•	•
Mix	•	•	•	•	•
Easy Care	•	•	•	•	•
Duvet		•	•	•	
Hygiene		•	•	•	
Baby Care		•	•	•	
Sports Wear		•	•	•	
Gentle Care			•	•	
Delicate		•	•	•	
Stain Care			•	•	•*
Silent Wash		•	•	•	
Speed 14	•*		•	•	

• * : This option is automatically included in the cycle and can not be deleted.

Operating Data

Programme	Max RPM	
	F4J**** FH4****	F2J****
Cotton	1400	1200
Cotton+	1400	1200
Mix	1400	1200
Easy Care	1000	1000
Duvet	1000	1000
Hygiene	1400	1200
Baby Care	1000	1000
Sports Wear	800	800
Gentle Care	800	800
Delicate	800	800
Stain Care	1400	1200
Silent Wash	1000	1000
Speed 14	800	800

[F4J*VN(P)0~9*]/[F2J*VN(P)0~9*]/[FH4U2VCN2]/ [FH4U2VCN8]

Programme	Time in Minutes		Remaining moisture content		Water in Litre	Energy in kWh
	9 kg		1400 rpm	1200 rpm	9 kg	9 kg
	1400 rpm	1200 rpm				
Cotton (40 °C)	96	94	44 %	53 %	52	0.40
Cotton+ (60 °C)	225	224	44 %	53 %	38	0.61

[F4J*TN(P)0~9*]/[F2J*TN(P)0~9*]/[FH4U2TDN(P)(0~9)*]

Programme	Time in Minutes		Remaining moisture content		Water in Litre	Energy in kWh
	8 kg		1400 rpm	1200 rpm		
	1400 rpm	1200 rpm			8 kg	8 kg
Cotton (40 °C)	96	94	44 %	53 %	52	0.40
Cotton+ (60 °C)	245	244	44 %	53 %	38	0.45

Option Programme

Delay End ()

You can set a time delay so that the washing machine will start automatically and finish after a specified time interval.

1. Press the Power button.
2. Select a washing program.
3. Press the Delay End button to set time required.
4. Press the Start/Pause button.

Pre Wash ()

If the laundry is heavily soiled, the Pre Wash program is recommended.

1. Press the Power button.
2. Select a washing program.
3. Press the Pre Wash button for three seconds.
4. Press the Start/Pause button.

Intensive ()

If the laundry is normal and heavily soiled, Intensive option is effective.

1. Press the Power button.
2. Select a washing program.
3. Press the Intensive button.
4. Press the Start/Pause button.

Wi-Fi ()

When Wi-Fi is connected, the Wi-Fi icon on the control panel is lit.

Turbo Wash ()

Wash cycle in under 1 hour with energy and water saving. (based on half of laundry)

1. Press the Power button.
2. Select a washing programme.
3. Press the Turbo Wash button.
4. Press the Start/Pause button.

Temp.

The Temp. button selects the wash and rinse temperature combination for the selected programme. Press this button until the desired setting is lit. All rinses use cold tap water.

- Select the water temperature suitable for the type of load you are washing. Follow the garment fabric care labels for best results.

Spin

- Spin speed level can be selected by pressing the Spin button repeatedly.
- Spin Only
 1. Press the Power button.
 2. Press the Spin button to select RPM.
 3. Press the Start/Pause button.

NOTE

- When you select No, it will still rotate for a short time to drain quickly.

Rinse

Rinse+ ()

Add rinse once.

Add Item ()

Laundry can be added or removed after the washing programme is started.

1. Press the Add Item button when the LED is turned on.
2. Add or remove laundry.
3. Close the door and Press the Start/Pause button.

Child Lock

Use this option to disable the controls. This feature can prevent children from changing cycles or operating the appliance

Locking the Control Panel

1. Press and hold the Child Lock button for three seconds.

2. A beeper will sound, and  will appear on the display.

When the Child Lock is set, all buttons are locked except the Power button.

Unlocking the Control Panel

Press and hold the Child Lock button for three seconds.

- A beeper will sound and the remaining time for the current programme will reappear on the display

Beep On / Off

1. Press the Power button.
2. Press the Start/Pause button.
3. Press and hold the Temp. and Spin button simultaneously for 3 seconds to set the Beep on/off function.

SMART FUNCTIONS

Using LG SmartThinQ Application

Things to check before using LG SmartThinQ



- For appliances with the SmartThinQ or SmartThinQ™ logo

1. Check the distance between the appliance and the wireless router (Wi-Fi network).

- If the distance between the appliance and the wireless router is too far, the signal strength becomes weak. It may take a long time to register or installation may fail.

2. Turn off the Mobile data or Cellular Data on your smartphone.

- For iPhones, turn data off by going to Settings → Cellular → Cellular Data.

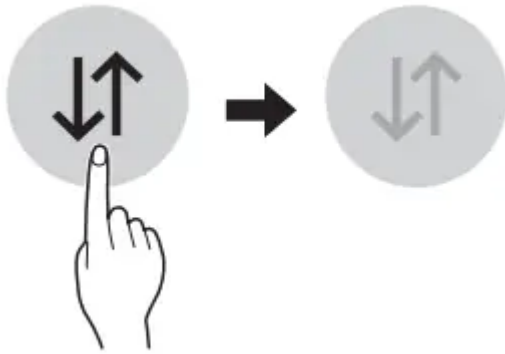

3. Connect your smartphone to the wireless router.

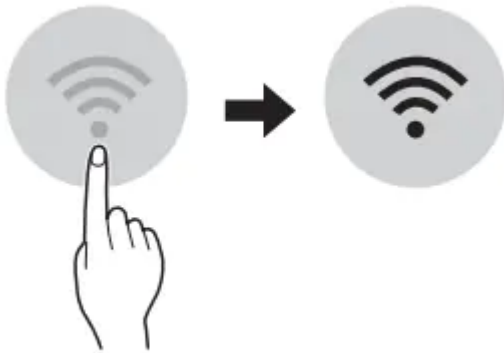

Installing LG SmartThinQ

Search for the LG SmartThinQ application from the Google Play Store or Apple App Store on a smart phone. Follow instructions to download and install the application.

Wi-Fi Function



• For appliances with the SmartThinQ or SmartThinQTM logo Communicate with the appliance from a smart phone using the convenient smart features.

Washer Cycle (Remote Start, Download Cycle)

Set or download any preferred cycle and operate by remote control.

Tub Clean Coach

This function shows how many cycles remain before It is time to run the Tub Clean cycle.

Energy Monitoring

Check the energy consumption of the recently used cycles and monthly average.

Smart Diagnosis™

This function provides useful information for diagnosing and solving issues with the appliance based on the pattern of use.

Settings

Various functions are available.

Push Alert

Turn on the Push Alerts to receive appliance status notifications. The notifications are triggered even if the LG SmartThinQ application is off.

Using Washer Cycle



Remote Start ()



Use a smartphone to control your appliance remotely. You can also monitor your cycle operation so you know how much time is left in the cycle.

To Use Remote Start:

1. Press the Power button.
2. Put the laundry in drum.
3. Press and hold Remote Start button for 3 seconds to enable Remote Start function.
4. Start a cycle from the LG Smart ThinQ application on your smart phone.

Smart Diagnosis™ Using a Smart Phone



- For appliances with the  or  logo Use this function if you need an accurate diagnosis by an LG Electronics customer information centre when the appliance malfunctions or fails.

Smart Diagnosis™ can not be activated unless the appliance is connected to power. If the appliance is unable to turn on, then troubleshooting must be done without using Smart Diagnosis™.

Using Smart Diagnosis™

Smart Diagnosis™ Through the Customer Information Centrer

Use this function if you need an accurate diagnosis by an LG Electronics service center when the product malfunctions or fails. Use this function only to contact the service representative, not during normal operation.

1. Press the Power button to turn on the washing machine. Do not press any other buttons or turn the program selector knob.
2. When instructed to do so by the call center, place the mouthpiece of your phone close to the Power button.

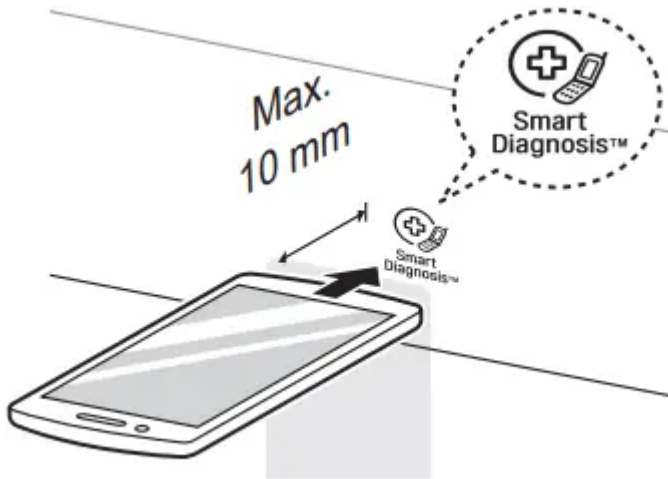

3. Press and hold the Temp. button for three seconds, while holding the phone mouthpiece to the icon or Power button.
4. Keep the phone in place until the tone transmission has finished. Time remaining for data transfer is displayed.
 - For best results, do not move the phone while the tones are being transmitted.
 - If the call center agent is not able to get an accurate recording of the data, you may be asked to try again.
5. Once the countdown is over and the tones have stopped, resume your conversation with the call center agent, who will then be able to assist you using the information transmitted for analysis.

MAINTENANCE

Cleaning Your Washing Machine

Care After Wash

- After the cycle is finished, wipe the door and the inside of the door seal to remove any moisture.

- Leave the door open to dry the drum interior.
- Wipe the body of the washing machine with a dry cloth to remove any moisture.

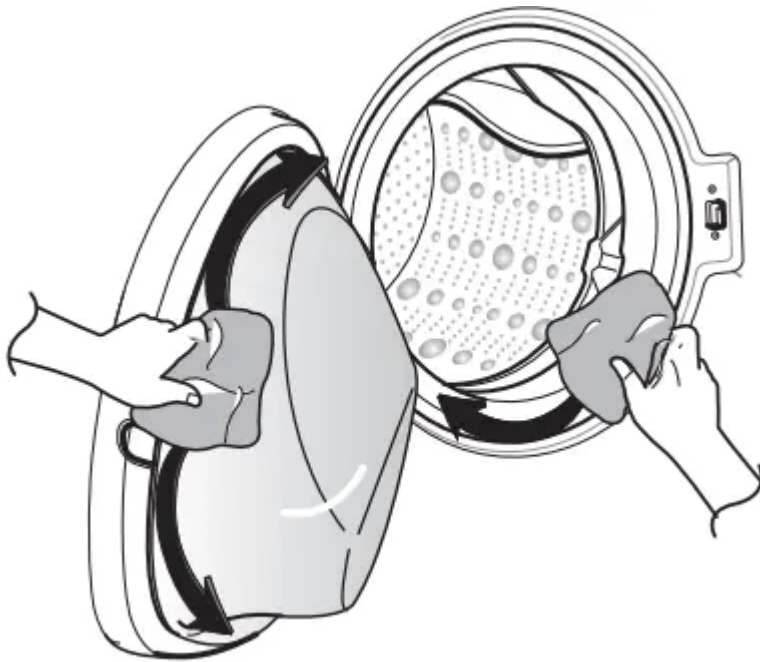

Cleaning the Exterior

Proper care of your washing machine can extend its life.

Door:

- Wash with a damp cloth on the outside and inside and then dry with a soft cloth.

Exterior:

- Immediately wipe off any spills.
- Wipe with a damp cloth.
- Do not press the surface or the display with sharp objects

Cleaning the Interior

- Use a towel or soft cloth to wipe around the washing machine door opening and door glass.
- Always remove items from the washing machine as soon as the cycle is complete. Leaving damp items in the washing machine can cause wrinkling, colour transfer, and odour.
- Run the Tub Clean programme once a month (or more often if needed) to remove detergent buildup and other residue

Cleaning the Water Inlet Filter

- Turn off the supply taps to the machine if the washing machine is to be left for any length of time (e.g. holiday), especially if there is no floor drain (gully) in the immediate vicinity.

- **IE** icon will be displayed on the control panel when water is not entering the detergent drawer.

- If water is very hard or contains traces of lime deposit, the water inlet filter may become clogged. It is therefore a good idea to clean it occasionally.

1. Turn off the water tap and unscrew the water supply hose.

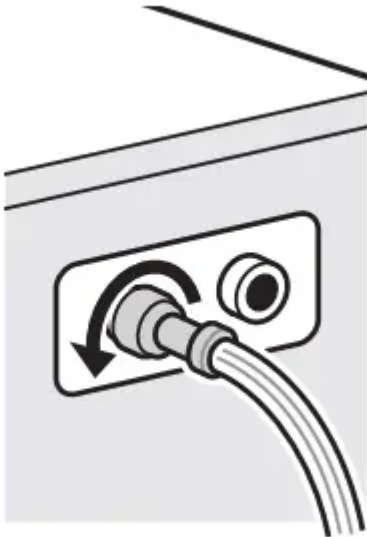

2. Clean the filter using a hard bristle brush.

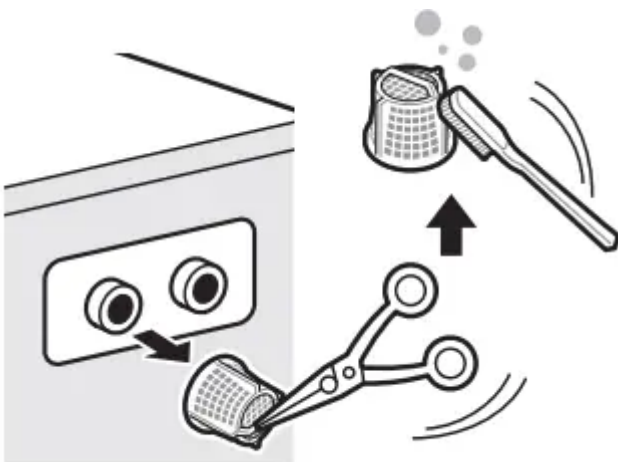

Cleaning the Drain Pump Filter

- The drain filter collects threads and small objects left in the laundry. Check regularly that the filter is clean to ensure smooth running of your washing machine.
- Allow the water to cool down before cleaning the drain pump, carrying out emergency emptying, or opening the door in an emergency

1. Open the cover cap and pull out the hose.

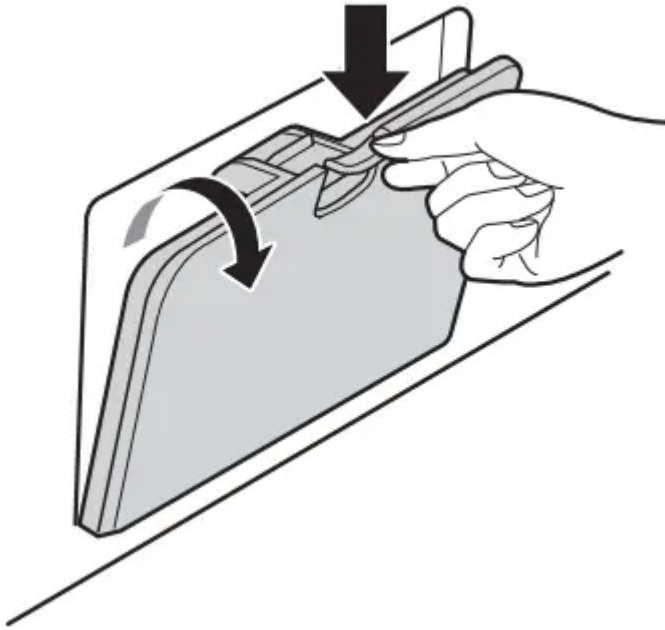

2. Unplug the drain plug and open the filter by turning it to the left.

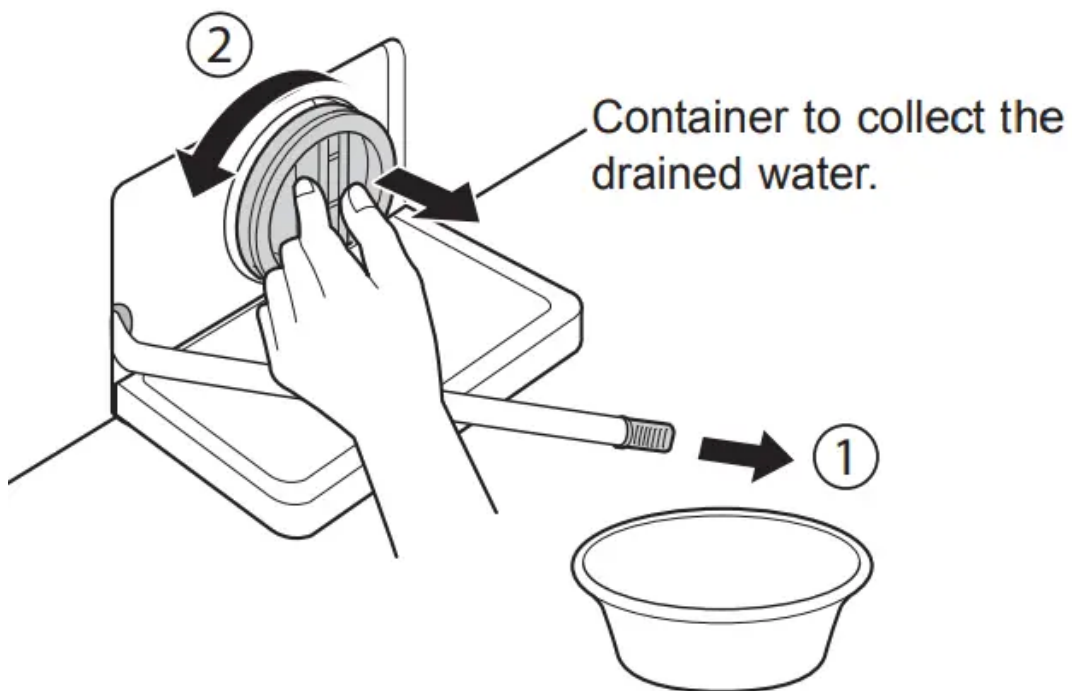

3. Remove any extraneous matter from the pump filter.

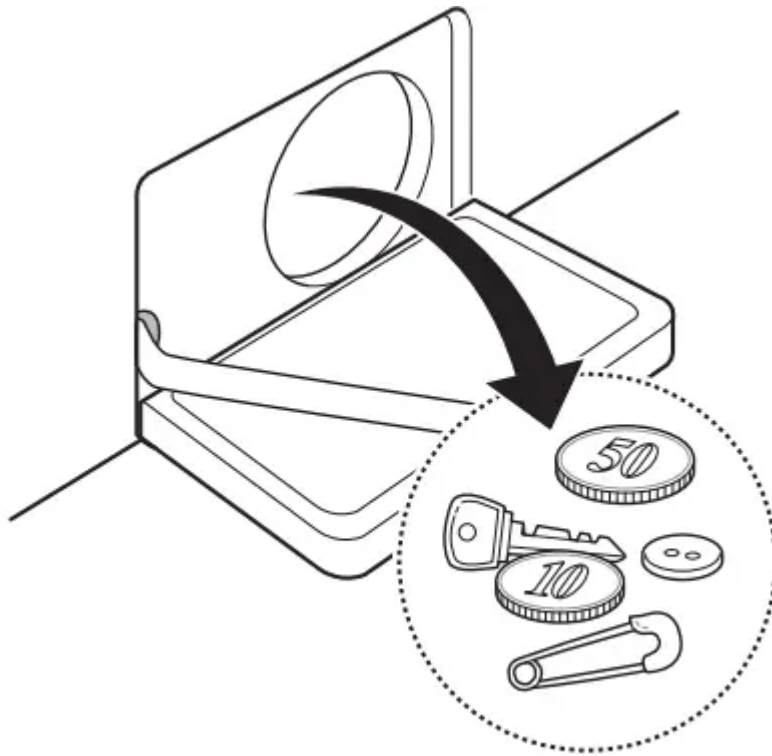

4. After cleaning, turn the pump filter and insert the drain plug.

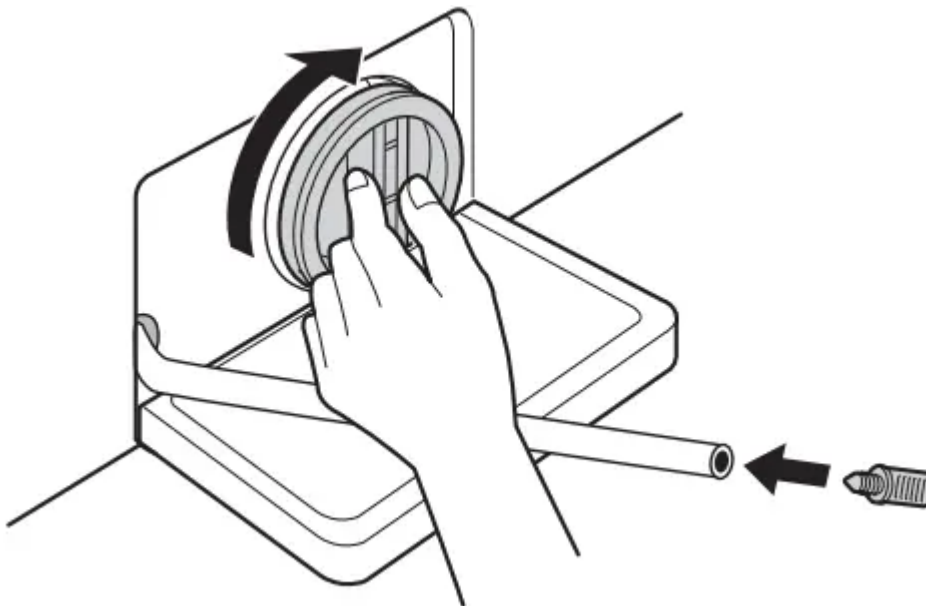

5. Close the cover cap

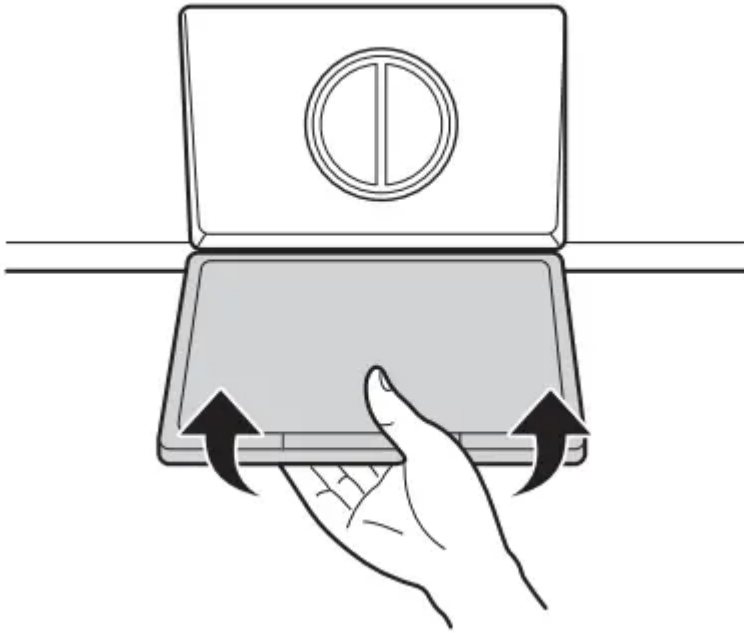

Cleaning the Dispenser Drawer

Detergent and fabric softener may build up in the dispenser drawer. Remove the drawer and inserts and check for buildup once or twice a month.

1. Remove the detergent dispenser drawer by pulling it straight out until it stops.
 - Press down hard on the disengage button and remove the drawer.

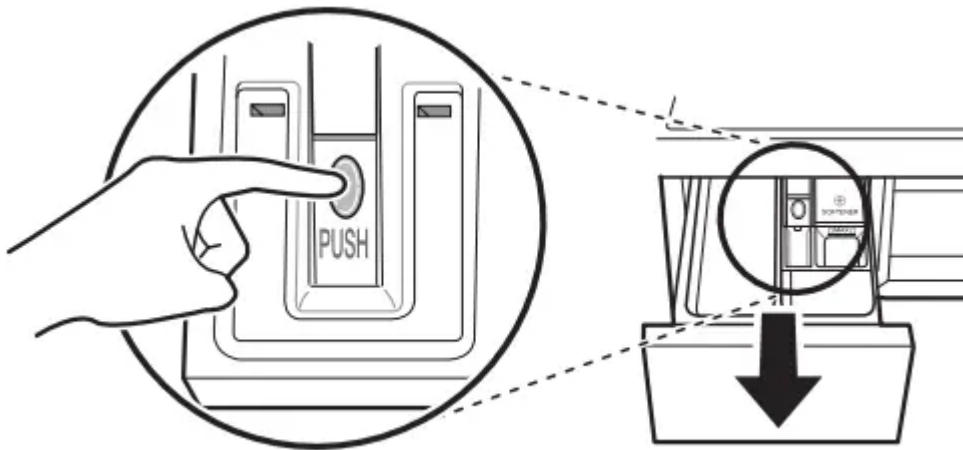

2. Remove the inserts from the drawer.

- Rinse the inserts and the drawer with warm water to remove buildup from laundry products. Use only water to clean the dispenser drawer. Dry the inserts and drawer with a soft cloth or towel.

3. To clean the drawer opening, use a cloth or small, non-metal brush to clean the recess.

- Remove all residue from the upper and lower parts of the recess.
4. Wipe any moisture off the recess with a soft cloth or towel.
 5. Return the inserts to the proper compartments and replace the drawer.

Tub Clean () (Optional)

Tub Clean is a special programme to clean the inside of the washing machine.

A higher water level is used in this programme at higher spin speed. Perform this programme regularly.

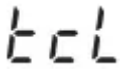
1. Remove any clothing or items from the washing machine and close the door.
2. Open the dispenser drawer and add anti-limescale (e.g. Calgon) to the main wash compartment.
 - For tablets put into the drum.
3. Close the dispenser drawer slowly.
4. Power on and then press and hold Tub Clean button for 3 seconds. Then  will be displayed on the display.
5. Press the Start/Pause button to start.
6. After the programme is complete, leave the door open to allow the washing machine door opening, flexible gasket and door glass to dry.

Caution on Freezing During Winter

- When frozen, the product does not operate normally. Make sure to install the product where it will not freeze during winter.
- In case the product must be installed outside on a porch or in other outdoor conditions, make sure to check the following.

How to Keep the Product from Freezing

- After washing, remove water remaining inside the pump completely with the opening hose plug used for removal of residual water. When the water is removed completely, close the hose plug used for removal of residual water and cover cap

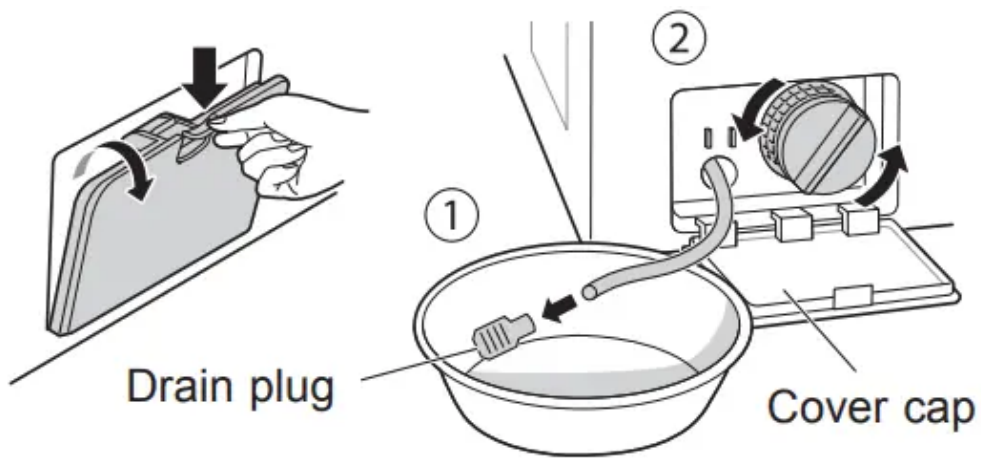

- Hang down drain hose to pull out water inside the hose completely.

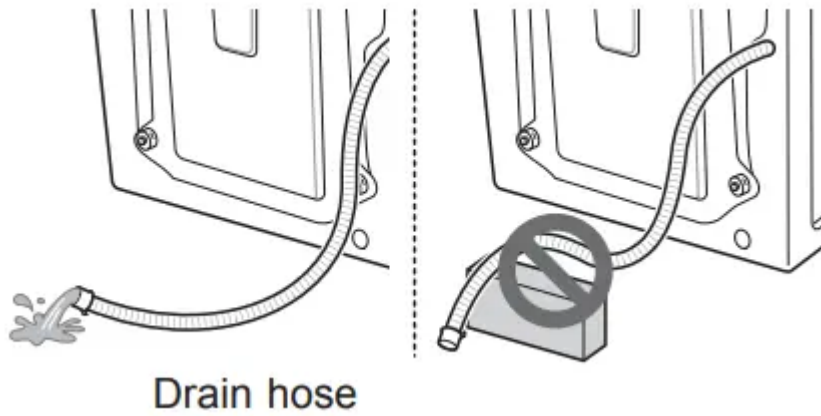

- After closing the tap, disconnect the cold supply hose from the tap, and remove water while keeping the hose facing downwards.

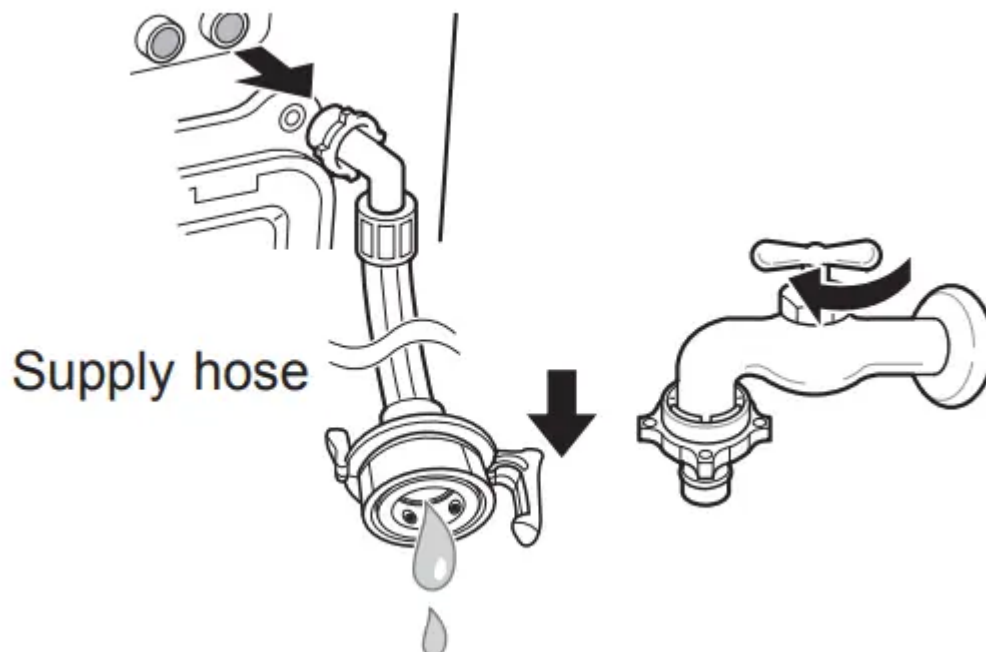

Check for Freezing

- If water does not drain when opening the hose plug used for removal of residual water, check the drainage unit.

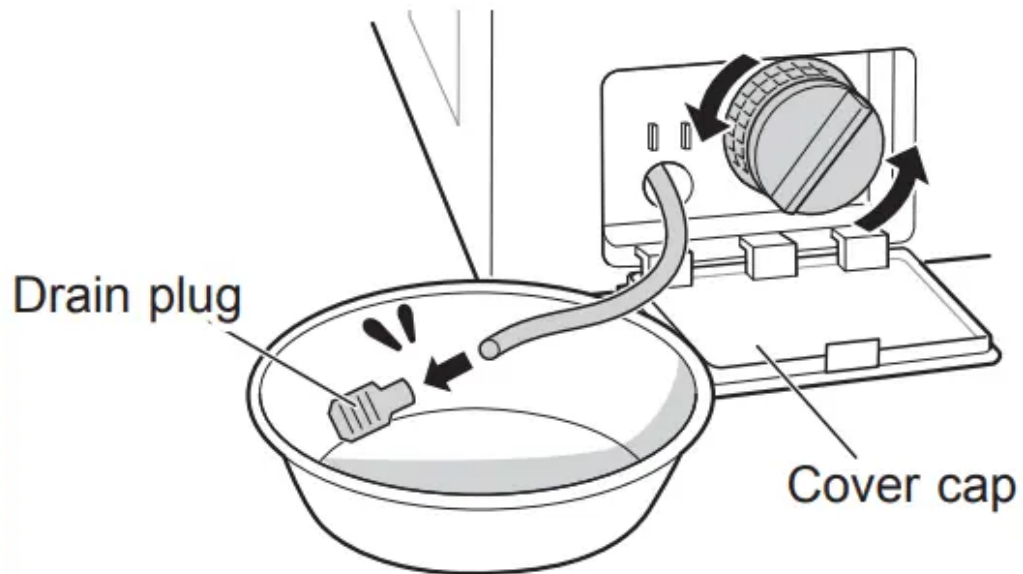

- Turn the power on, choose a washing programme, and press the Start/Pause button.



Detergent drawer

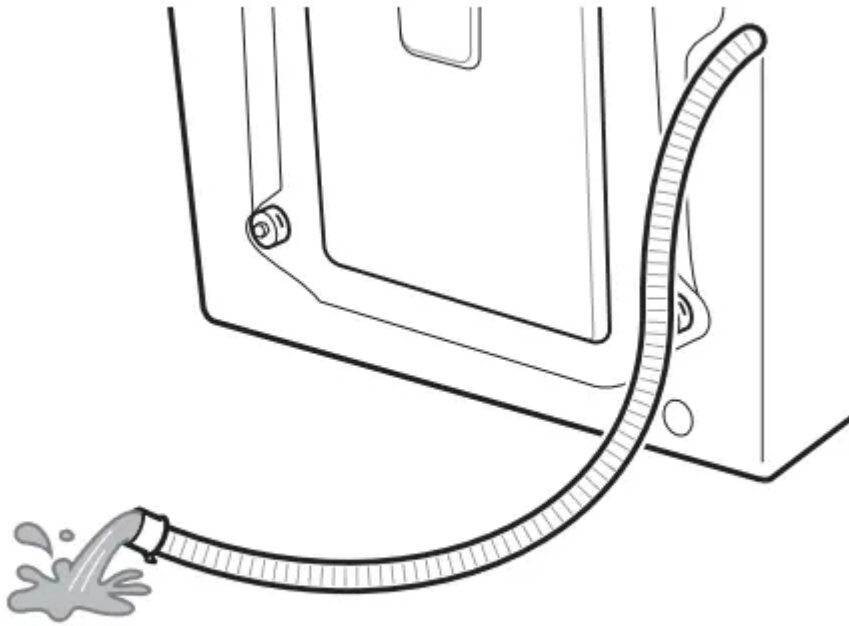

Drain hose

- When 'FF' is shown in display window while the product is in operation, check water supply unit and drainage unit (Some models do not have an alarm function that indicates freezing).

How to Handle Freezing

- Make sure to empty the drum, pour warm water of 50–60 °C up to the rubber part inside the drum, close the door, and wait for 1–2 hours.

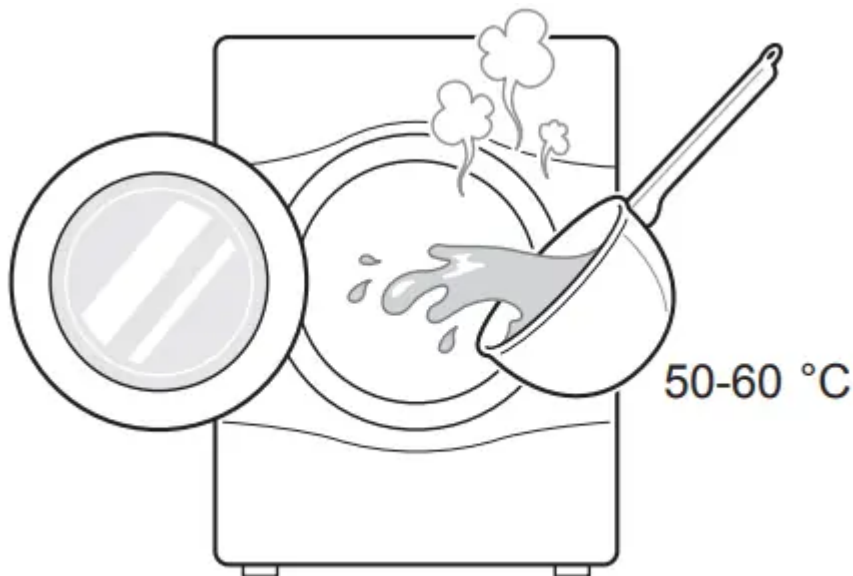

- When the drain hose is installed in a curved shape, the inner hose may freeze.

- Open the cover cap and hose plug used for removal of residual water to extract water completely

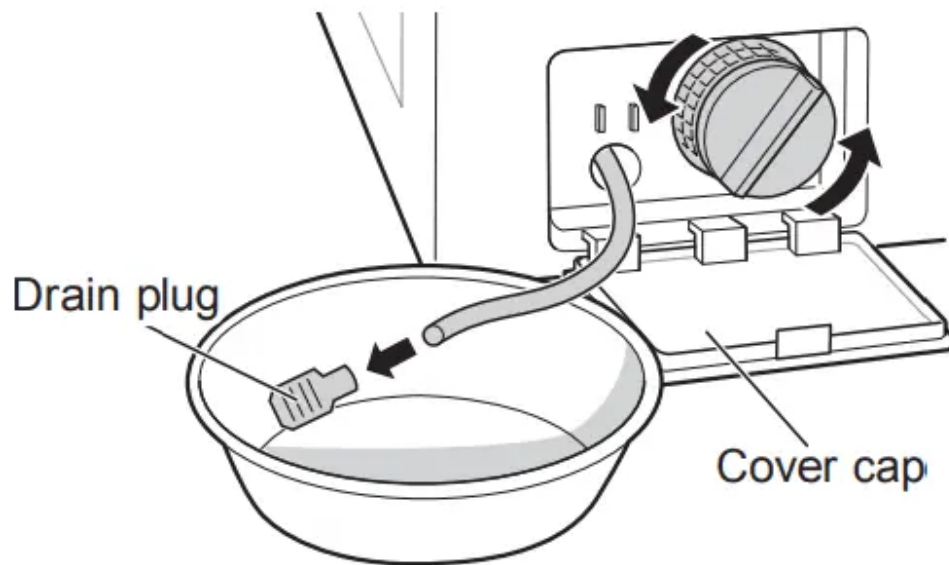

- If water does not drain, this means the ice is not melted completely. Wait more.
- When water is removed completely from the drum, close the hose plug used for removal of residual water, choose a washing programme, and press the Start/Pause button.



Detergent drawer

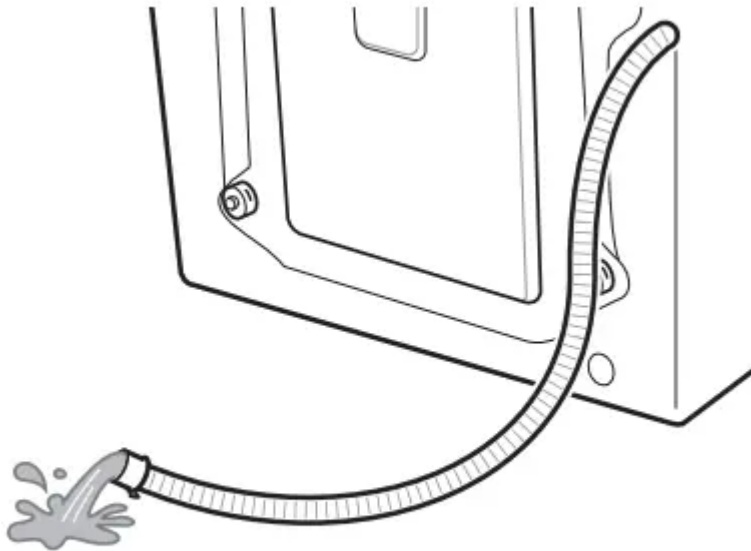

Drain hose

- Check that water is coming into the detergent drawer while rinsing, and water is draining through the drain hose while spinning.
- When water supply problems occur, take the following measures.
 - Turn off the tap, and thaw out the tap and both connection areas of inlet hose of the product using a hot water cloth.
 - Take out inlet hose and immerse in warm water below 50–60 °C.

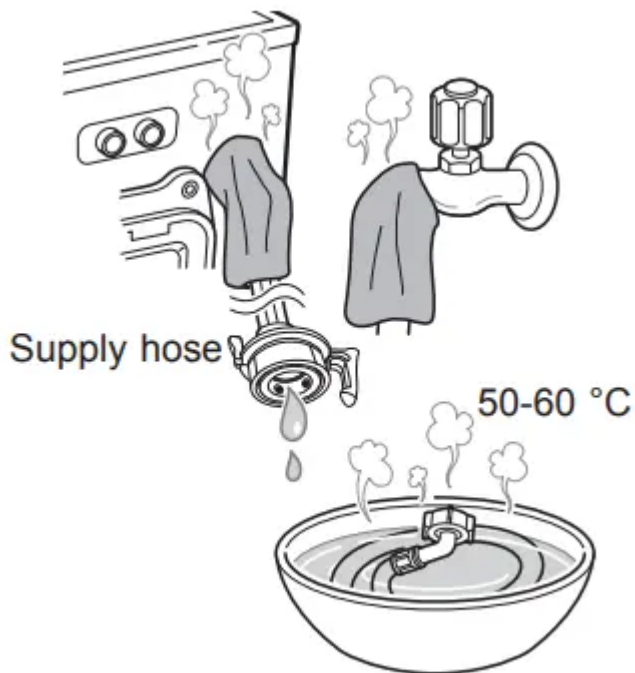

TROUBLESHOOTING

Diagnosing Problems



Symptoms	Reason	Solution
Rattling and clanking noise	Foreign objects such as coins or safety pins may be in drum or pump.	<ul style="list-style-type: none"> • Check all pockets to make sure that they are empty. Items such as clips, matches, pens, coins, and keys can damage both your washer and your clothes. • Close zippers, hooks, and drawstrings to prevent these items from snagging or tangling on other clothes.
Thumping sound	Heavy wash loads may produce a thumping sound. This is usually normal.	<ul style="list-style-type: none"> • If sound continues, washing machine is probably out of balance. Stop and redistribute wash load.
Vibrating noise	Have all the transit bolts and tub support been removed?	<ul style="list-style-type: none"> • If not removed during installation, refer to Installation guide for removing transit bolts.
	Are all the feet resting firmly on the ground?	<ul style="list-style-type: none"> • Make sure the washing machine is level and tighten the lock nuts up towards the base of the appliance.
Water leaks	Supply hoses or drain hose are loose at tap or washing machine.	<ul style="list-style-type: none"> • Check and tighten hose connections.
	House drain pipes are clogged.	<ul style="list-style-type: none"> • Unclog drain pipe. Contact plumber if necessary
Oversudsing	Too much detergent or unsuitable detergent may cause excessive foaming which may result in water leaks.	<ul style="list-style-type: none"> • Make sure that the suggested amount of detergent is used per the manufacturer's recommendations.
Water does not enter washing		<ul style="list-style-type: none"> • Check another tap in the house.

machine or it enters slowly	Water supply is not adequate in that location.	
	Water supply tap is not completely open.	<ul style="list-style-type: none"> • Fully open tap.
	Water supply hose(s) are kinked.	<ul style="list-style-type: none"> • Straighten hose.
	The filter of the supply hose(s) clogged.	<ul style="list-style-type: none"> • Check the filter of the supply hose.
Water in the washing machine does not drain or drains slowly	Drain hose is kinked or clogged.	<ul style="list-style-type: none"> • Clean and straighten the drain hose.
	The drain filter is clogged.	<ul style="list-style-type: none"> • Clean the drain filter.
Washing machine does not start	Electrical power cord may not be plugged in or connection may be loose.	<ul style="list-style-type: none"> • Make sure plug fits tightly in wall outlet.
	House fuse blown, circuit breaker tripped, or a power outage has occurred.	<ul style="list-style-type: none"> • Reset circuit breaker or replace fuse. Do not increase fuse capacity. If problem is a circuit overload, have it corrected by a qualified electrician.
	Water supply tap is not turned on.	<ul style="list-style-type: none"> • Turn on water supply tap.
Washing machine will not spin	Check that the door is firmly shut.	<ul style="list-style-type: none"> • Close the door and press the Start/ Pause button. After pressing the Start/ Pause button, it may take a few moments before the washing machine begins to spin. The door must be locked before spin can be achieved. Add 1 or 2 similar items to help balance the load. Rearrange load to allow proper spinning.
Door does not open	Once washing machine has started,	

	the door cannot be opened for safety reasons	<ul style="list-style-type: none"> • Check if the 'Door Lock' icon is illuminated. You can safely open the door after the 'Door Lock' icon turns off.
Wash cycle time delayed	If an imbalance is detected or if the suds removing program is on, the wash time will increase.	<ul style="list-style-type: none"> • This is normal. The time remaining shown in the display is only an estimate. Actual time may vary
Fabric softener overflow	Too much softener may cause an overflow.	<ul style="list-style-type: none"> • Follow softener guidelines to ensure appropriate amount is used. Do not exceed the maximum fill line.
Softeners dispensed too early	Too much softener may cause an premature dispensing.	<ul style="list-style-type: none"> • Follow the guidelines provided by the detergent manufacturer. • Close the dispenser drawer slowly. Do not open the drawer during the wash cycle.
The buttons may not function properly.	The button cannot be recognized when the door is open.	<ul style="list-style-type: none"> • Press again after closing the door
Dry problem	Check water supply tap.	<ul style="list-style-type: none"> • Do not overload. Check that the washing machine is draining properly to extract adequate water from the load. Clothes load is too small to tumble properly. Add a few towels. • Turn off water supply tap.
Odor	This odor is caused by the rubber attached to the washing machine.	<ul style="list-style-type: none"> • It is the normal odor of new rubber and will disappear after the machine has been run a few times.
	If the rubber door gasket and door seal area are not cleaned regularly, odors can	<ul style="list-style-type: none"> • Be sure to clean the gasket and door seal regularly and check under the door seal for small items when unloading the washer.

	occur from mold or foreign substances.	
	Odors can occur if foreign substances are left in the drainage pump filter.	Be sure to clean the drainage pump filter regularly
	Odors can occur if the drainage hose is not properly installed, causing siphoning (water flowing back inside the washing machine).	<ul style="list-style-type: none"> • When installing the drainage hose, be sure that it doesn't become kinked or blocked.
	Using the dry function, odors can occur from lint and other laundry matter sticking to the heater. (Dryer model only)	<ul style="list-style-type: none"> • This is not a malfunction.
	A particular odor can occur from drying wet clothes with hot air. (Dryer model only)	<ul style="list-style-type: none"> • The odor will disappear after a short while.
Your home appliance and smartphone is not connected to the Wi-Fi network.	The password for the Wi-Fi that you are trying to connect to is incorrect.	<ul style="list-style-type: none"> • Find the Wi-Fi network connected to your smartphone and remove it, then register your appliance on LG SmartThinQ.
	Mobile data for your smartphone is turned on.	<ul style="list-style-type: none"> • Turn off the Mobile data of your smartphone and register the appliance using the Wi-Fi network.
	The wireless network name (SSID) is set incorrectly	<ul style="list-style-type: none"> • The wireless network name (SSID) should be a combination of English letters and numbers. (Do not use special characters.)



	<p>The router frequency is not 2.4 GHz.</p>	<ul style="list-style-type: none"> • Only a 2.4 GHz router frequency is supported. Set the wireless router to 2.4 GHz and connect the appliance to the wireless router. To check the router frequency, check with your Internet service provider or the router manufacturer
	<p>The distance between the appliance and the router is too far.</p>	<ul style="list-style-type: none"> • If the distance between the appliance and the router is too far, the signal may be weak and the connection may not be configured correctly. Move the location of the router so that it is closer to the appliance.

Error Messages

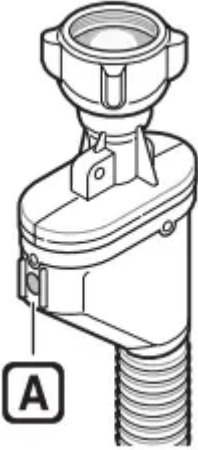

Symptoms	Reason	Solution
	Water supply is not adequate in area.	<ul style="list-style-type: none"> • Check another tap in the house.
	Water supply taps are not completely open.	<ul style="list-style-type: none"> • Fully open tap.
	Water supply hose(s) are kinked.	<ul style="list-style-type: none"> • Straighten hose(s).
	The filter of the supply hose(s) are clogged.	<ul style="list-style-type: none"> • Check the filter of the supply hose.
	<p>If water leakage occurred in the aqua stop supply hose, indicator A will become red</p>  <p>May vary depending on the model.</p>	<ul style="list-style-type: none"> • Use the aqua stop supply hose.
	Load is too small.	<ul style="list-style-type: none"> • Add 1 or 2 similar items to help balance the load.
	Load is out of balance.	<ul style="list-style-type: none"> • Add 1 or 2 similar items to help balance the load.
	The appliance has an imbalance detection and correction system. If individual heavy articles are loaded (e.g. bath mat, bath robe, etc.) this system may stop spinning or even interrupt the spin cycle altogether.	<ul style="list-style-type: none"> • Rearrange load to allow proper spinning.

	If the laundry is still too wet at the end of the cycle, add smaller articles of laundry to balance the load and repeat the spin cycle.	<ul style="list-style-type: none"> • Rearrange load to allow proper spinning.
	Drain hose is kinked or clogged.	<ul style="list-style-type: none"> • Clean and straighten the drain hose
	The drain filter is clogged.	<ul style="list-style-type: none"> • Clean the drain filter.
	Ensure door is not open.	<ul style="list-style-type: none"> • Close the door completely. If <i>dE, dE 1, dE2, dE4</i> is not released, call for service.
	Door sensor has malfunctioned.	
	Control error.	<ul style="list-style-type: none"> • Unplug the power plug and call for service.
	Water overfills due to the faulty water valve.	<ul style="list-style-type: none"> • Close the water tap. • Unplug the power plug. • Call for service.
	Malfunction of water level sensor.	<ul style="list-style-type: none"> • Close the water tap. • Unplug the power plug. • Call for service.
	Over load in motor.	<ul style="list-style-type: none"> • Allow the washing machine to stand for 30 minutes to allow the motor to cool, then restart the cycle.
	Is supply/drain hose or drain pump frozen?	<ul style="list-style-type: none"> • Supply warm water into the drum and unfreeze drain hose and drain pump. Wet a towel in warm water and apply to supply hose.

	Water leaks.	• Call for service.
	Does not dry	• Call for service.

Warning

This content is compiled from multiple sources and is provided for reference purposes only. It may not be complete or fully applicable to all situations. If you are unable to resolve your issue, please contact the product manufacturer or an authorized service provider for official support.

