

CONTROL PANELS

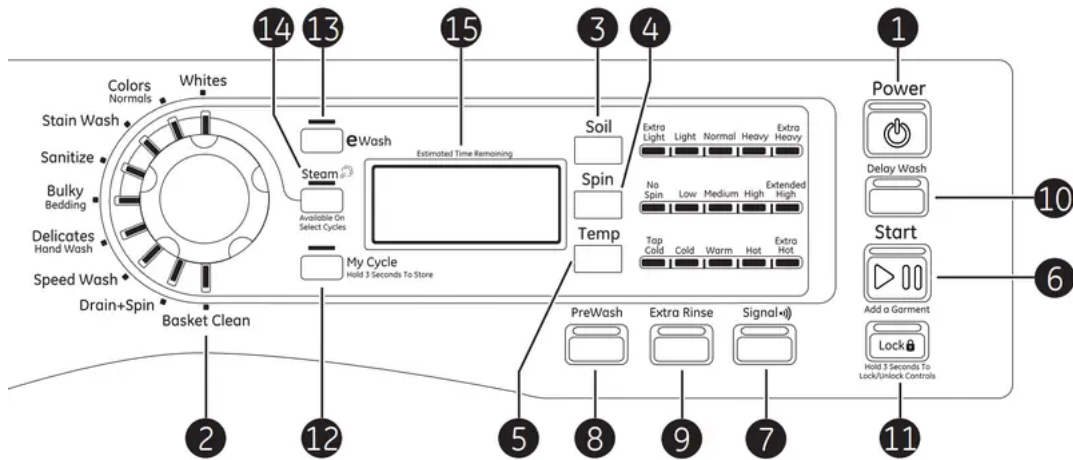

1. Power

Press to “wake up” the display. If the display is active, press to put the washer into standby mode.

NOTE: Pressing Power does not disconnect the appliance from the power supply.

2. Wash Cycles

The wash cycles are optimized for specific types of wash loads. The chart below will help you match the wash setting with the loads. The GentleClean™ lifters lightly tumble the clothes into the water and detergent solution to clean the load.

Whites	For heavily to lightly soiled white laundry.
Colors/ Normals	For heavily to lightly soiled colorfast cottons, household linens, work and play clothes.
Stain Wash	For heavily soiled colorfast laundry.
Sanitize	When selecting sanitize, the washer increases the water temperature to sanitize (on some models) and remove 99.9% of bacteria found in home laundry. For best results, select the heavy soil setting when using the sanitize cycle.
 <div style="border: 1px solid black; padding: 5px; display: inline-block;"> <p style="margin: 0;">NSF Protocol P172 Sanitization Performance of Residential and Commercial, Family-Sized Clothes Washers</p> </div>	
Bulky Bedding (on some models)	For large coats, bed spreads, mattress covers, sleeping bags and similar large and bulky items. Large items such as blankets, comforters, jackets and small rugs.
Delicates	For lingerie and special-care fabrics with light to normal soil. Provides gentle tumbling and soak during wash and rinse.
Speed Wash	For lightly soiled items that are needed in a hurry. Cycle time is approximately minutes, depending on selected options.
Drain & Spin	Drain and spin at any time.
Basket Clean	Use for cleaning the basket of residue and odor. Recommended use of once per month.

NOTE: Never load laundry while using Basket Clean. The laundry may become damaged or contaminated. See the Care and Cleaning section.

3. Soil Level

Changing the **Soil** level increases or decreases the wash time to remove different amounts of soil.

To change the **Soil** level, press the Soil level pad until you have reached the desired setting.

4. Spin Speed

Changing the **Spin** speed changes the final spin speed of the cycles. Always follow the fabric manufacturer's care label when changing the spin speed.

To change the spin speed, press the **Spin** speed pad until you have reached the desired setting. Higher spin speeds are not available on certain cycles, such as **Delicates**.

Higher spin speeds remove more water from the clothes and will help reduce dry time, but may also increase the possibility of setting wrinkles on some fabrics.

5. Wash Temp

Adjust to select the proper water temperature for the wash cycle. The prewash and rinse water is always cold to help reduce energy usage and reduce setting of stains and wrinkles.

Follow the fabric manufacturer's care label when selecting the wash temperature.

To change the wash temperature, press the **Wash Temp** pad until you have reached the desired setting.





NOTE: The first 10 seconds of the wash fill is always cold. This feature assists in conditioning the fabric and preventing stains from setting on garments.

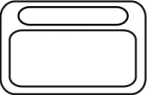

6. Start/Add a Garment

Press to start a wash cycle. If the washer is running, pressing it once will pause the washer and unlock the door. Press again to restart the wash cycle.

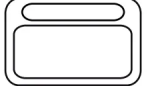
NOTE: If the washer is paused and the cycle is not restarted within 2 hours, the current wash cycle will be cancelled.

NOTE: The washer performs automatic system checks after pressing the Start pad. Water will flow in 45 seconds or less. You may hear the door lock and unlock before water flows; this is normal.

7.	<p>Signal </p> 	<p>Cycle Signal</p> <p>Use the Signal pad to change the volume of the end of cycle signal. Press the pad until you reach the desired volume.</p>
8.	<p>PreWash</p> 	<p>Prewash (on some models)</p> <p>Prewash is an extra wash before the main wash. Use it for heavily soiled clothes or for clothes with a care label that recommends prewashing before washing. Be sure to add high-efficiency detergent, or the proper wash additive to the prewash dispenser.</p> <p>NOTE: When selecting prewash, it is recommended to use powder detergent in the main wash (detergent) compartment.</p>
9.	<p>Extra Rinse</p> 	<p>Extra Rinse</p> <p>Use an extra rinse when additional rinsing is desired to remove excess dirt and detergent from soiled loads.</p>
10.	<p>Delay Wash</p> 	<p>Delay Wash (on some models)</p> <p>You can delay the start of a wash cycle for 10–18 hours, depending on the model. Press the Delay Wash pad to choose the number of hours you want to delay the start of the cycle, then press the Start pad. The machine will count down and start automatically at the correct time.</p> <p>NOTE: If you forget to fully close the door, a reminder signal will beep reminding you to do so.</p> <p>NOTE: If you open the door when the delay is counting down, the machine will enter the pause state. You must close the door and press Start again in order to restart the countdown.</p>
11.	 <p>Hold 3 Seconds To Lock/Unlock Controls</p>	<p>Lock</p> <p>You can lock the controls to prevent any selections from being made. Or you can lock the controls after you have started a cycle.</p> <p>Children cannot accidentally start the washer by touching pads with this option selected.</p>

		<p>To lock the washer controls, press and hold the Lock pad for 3 seconds.</p> <p>To unlock the washer controls, press and hold the Lock pad for 3 seconds.</p> <p>The control lock icon on the display will light up when it is on.</p> <p>NOTE: The Power pad can still be used when the machine is locked.</p>
12.		<p>My Cycle (on some models)</p> <p>To save a favorite cycle, set the desired settings for wash cycle, soil level, spin speed and wash temp settings and hold down the My Cycle pad for 3 seconds. A beep will sound to indicate the cycle has been saved.</p> <p>To use your custom cycle, press the My Cycle pad before washing a load.</p> <p>To change the saved cycle, set the desired settings and hold down the My Cycle pad for 3 seconds.</p> <p>NOTE: When using My Cycle, wash options cannot be modified after the cycle has been started.</p> <p>NOTE: If you change wash options with My Cycle before starting the cycle, the My Cycle light will turn off and you will be returned to the base cycle.</p>
13.		<p>eWash (Energy Saving Wash)</p> <p>Use eWASH to save energy on specified wash cycles. eWASH cannot be used with Steam Refresh, Stain Wash or Basket Clean .</p>
14.		<p>Steam (on some models)</p> <p>Steam adds steam into the washer during Whites, Colors/ Normals, Stain Wash, Sanitize or Bulky Bedding cycles.</p> <p>To use:</p> <ol style="list-style-type: none"> 1. Turn Power on and select a wash cycle. <ul style="list-style-type: none"> ◦ The Steam option is only available on Whites, Colors/Normals, Stain Wash, Sanitize or Bulky Bedding cycles.

		<p>2. Press Steam pad to activate.</p> <p>3. Press the Start pad.</p>
15.		<p>Display</p> <p>The display shows the approximate time remaining until the end of the cycle.</p> <p>NOTE: The cycle time is affected by how long it takes the washer to fill. This depends on the water pressure in your home.</p>

FEATURES

The Dispenser Drawer

	<p>Slowly open the dispenser drawer by pulling it out until it stops.</p> <p>After adding laundry products, slowly close the dispenser drawer. Closing the drawer too quickly could result in early dispensing of the bleach, fabric softener or detergent.</p> <p>You may see water in the bleach and fabric softener compartments at the end of the cycle.</p> <p>This is a result of the flushing/siphoning action and is part of the normal operation of the washer.</p>
--	--

The Prewash Compartment (on some models)

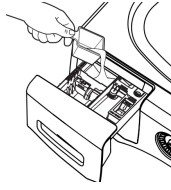

- Only use the Prewash Compartment if you are selecting the Prewash cycle for heavily soiled clothes. Add measured detergent or prewash additive to the back left prewash compartment of the dispenser drawer.
- Detergent or prewash additive is flushed from the dispenser in the prewash cycle if selected).

NOTE: Liquid detergent will drain into the washer drum as it is added.

- Detergent usage may need to be adjusted for water temperature, water hardness, size and soil level of the load. Avoid using too much detergent in your washer as it can lead to over sudsing and detergent residue being left on the clothes.

The Detergent Compartment

- **High-efficiency detergent is required for this washer. Use the detergent manufacturer's recommended amount.**

The detergent selection insert must be placed in the detergent compartment in a specific position according to what type of detergent you are using.

- **Powder Detergent** – Remove the detergent selection insert.
- **Liquid Detergent** – You will need to adjust the insert according to the type of Liquid

Detergent you are using. The Icons on the side of the detergent compartment must line up on the center when the insert is in position.

NOTE: Not all models have the 2x and 3x detergent settings. Some have only regular HE detergent settings. You must reduce the amount of detergent for 2x or 3x detergent per bottle instructions.

Move the insert by pulling it up and replace it by sliding it down between either the rear or front detergent compartment molded rails, as desired, for liquid detergent. Remove for powder detergent.

- Add measured detergent to the front left detergent compartment of the dispenser drawer.
- Detergent is flushed from the dispenser at the beginning of the wash cycle. Either powdered or liquid detergent can be used.

- Detergent usage may need to be adjusted for water temperature, water hardness, size and soil level of the load. Avoid using too much detergent in your washer as it can lead to oversudsing and detergent residue being left on the clothes.
- Using more detergent than the recommended quantity can cause residue buildup on your washer.

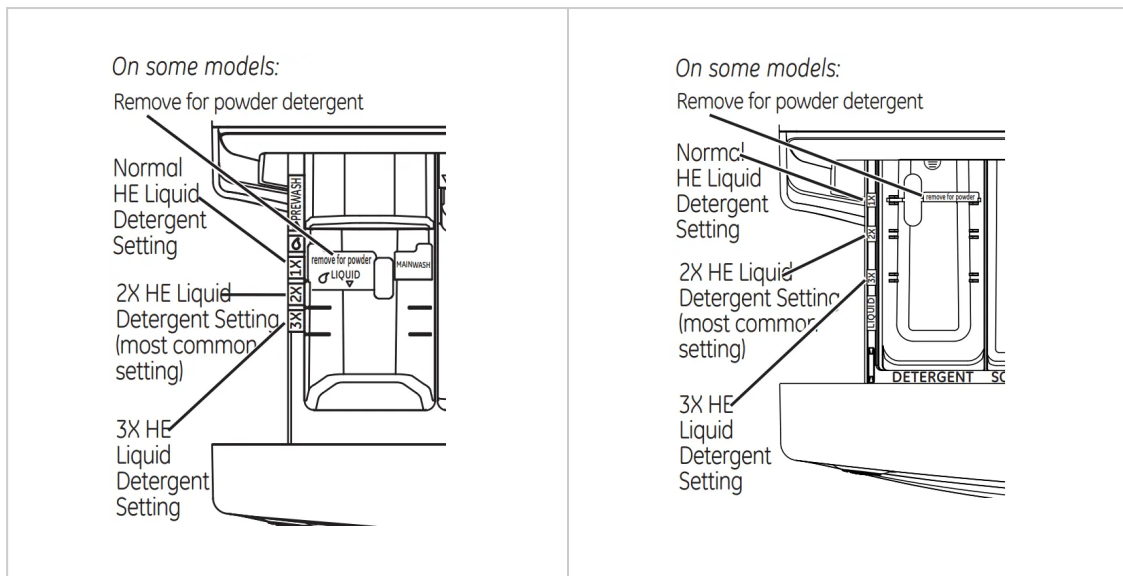

The Liquid Bleach Compartment

IMPORTANT: The bleach compartment position varies by model. Be sure to identify the correct compartment for bleach before using.

If desired, measure out the recommended amount of liquid bleach, not to exceed cup (80 ml), and pour into the right compartment labeled "LIQUID BLEACH".

Do not exceed the maximum fill line. Overfilling can cause early dispensing of the bleach which could result in damaged clothes.

NOTE: Do not use powdered bleach in the dispenser.

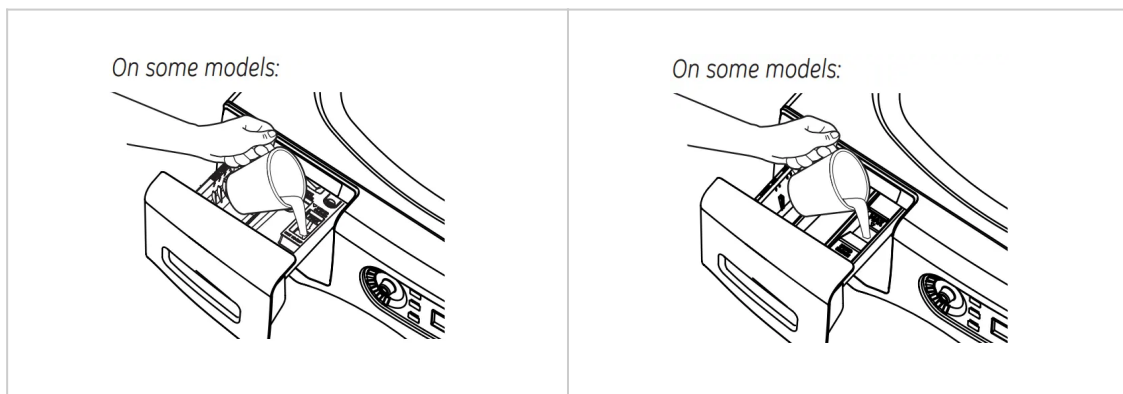

The Fabric Softener Compartment

IMPORTANT: The fabric softener compartment position varies by model. Be sure to identify the correct compartment for fabric softener before using.

If desired, pour the recommended amount of liquid fabric softener into the compartment labeled “FABRIC SOFTENER.”

Use only liquid fabric softener in the dispenser.

Dilute with water to the maximum fill line.

Do not exceed the maximum fill line. Overfilling can cause early dispensing of the fabric softener which could stain clothes.

NOTE: Do not pour fabric softener directly on the wash load.

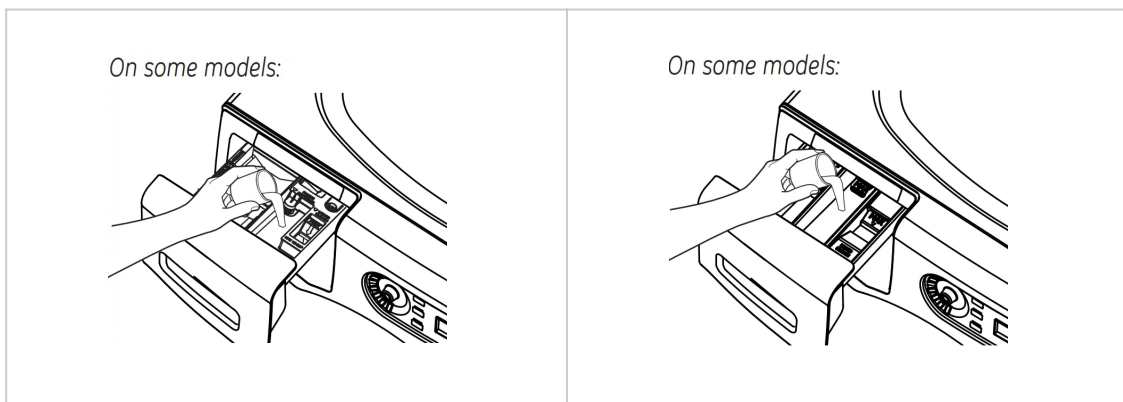

LOADING AND USING THE WASHER

Sorting Wash Loads

Sort laundry into loads that can be washed together.

Colors	Soil	Fabric	Lint
Whites	Heavy	Delicates	Lint Producers
Lights	Normal	Easy Care	Lint Collectors
Darks	Light	Sturdy Cottons	

- Combine large and small items in a load. Load large items first. Large items should not be more than half the total wash load.
- Washing single items is not recommended. This may cause an out-of-balance load. Add one or two similar items.
- Pillows and comforters should not be mixed with other items. This may cause an out-of-balance load

WARNING Fire Hazard

Never place items in the washer that are dampened with gasoline or other flammable liquids.

No washer can completely remove oil.

Do not dry anything that has ever had any type of oil on it (including cooking oils).

Doing so so can result in death, explosion, or fire.

Preparing Clothes

- To avoid snags during washing: Follow these steps to maximize garment care.
 - Close garment zippers, snaps, buttons and hooks.
 - Mend seams, hems, tears.
 - Empty all items from pockets.
 - Remove nonwashable garment accessories such as ornaments and nonwashable trim materials.
 - To avoid tangling, tie strings, draw ties and belt-like materials.
 - Brush away surface dirt and lint; treat spots and stains.
 - Promptly wash wet or stained garments to maximize results.
 - Mix garments using recommended maximum load sizes on page 11.
 - Use nylon mesh garment bags to wash small items.
 - Wash multiple garments at one time for best results.
-

Loading the Washer

Wash drum may be fully loaded with loosely added items. **Do not wash fabrics containing flammable materials (waxes, cleaning fluids, etc.).**

To add items after washer has started, press **Start** and wait until the door is unlatched. The washer may take up to 30 seconds to unlock the door after pressing **Start** depending on the machine conditions. Do not try to force open the door when it is locked. After the door unlocks, open gently. Add items, close the door and press **Start** to restart.

Maximum Loading Sizes*

WORKWEAR	LINENS	MIXED LOAD	DELICATES**	SPEED WASH (2-4 GARMENTS)
4 Jeans 5 Workwear Shirts 5 Workwear Pants	2 Bath Sheets 10 Bath Towels/ 12 Washcloths 7 Hand Towels/ 2 Terrycloth Bath Mats OR 2 Flat Queen-Sized Sheets 2 Fitted Queen-Sized Sheets 4 Pillowcases	4 Pillowcases 2 Hand Towels 2 Flat Sheets/ 2 Fitted Sheets 2 Bath Towels/ 4 Washcloths OR 6 Shirts (Men's or Women's) 4 Pair Pants (Khakis or Twills) 5 T-Shirts 7 Pairs of Boxers 4 Pairs of Shorts OR 6 T-Shirts 4 Pairs of Sweatpants 4 Sweatshirts 2 Hoodies 7 Pairs of Socks	7 Bras 7 Panties 3 Slips 2 Camisoles 4 Nightgowns	2 Casual Wear Work Shirts 1 Pair Casual Wear Work Pants OR 3 Soccer Uniforms

*Exceeding maximum recommended load sizes may affect cleaning performance and garment care.

**Using a nylon mesh bag for small items is recommended.

CARE AND CLEANING

Exterior: Immediately wipe off any spills. Wipe with damp cloth. Do not hit surface with sharp objects.

Moving and Storage: Ask the service technician to remove water from drain pump and hoses.

Do not store the washer where it will be exposed to the weather. When moving the washer, the tub should be kept stationary by using the shipping bolts removed during installation.

See Installation Instructions in this book. If these parts are not available, they can be ordered by visiting our Website at GEAppliances.com or by calling 800.GE.CARES. In Canada, call 800.561.3344.

Long Vacations: Be sure the water supply is shut off at the faucets. Drain all water from the hoses if the weather will be below freezing.

Cleaning the Interior of the Washer

To clean the interior of the washer, select the Basket Clean feature on the control panel. The cycle will use more water, in addition to bleach, to refresh your washer.

NOTE: Read the instructions below completely before starting the **Basket Clean** cycle.

1. Remove any garments or objects from the washer and ensure the washer basket is empty.
2. Open the washer door and pour one cup or 250 ml of liquid bleach or other washing machine cleaner into the basket.

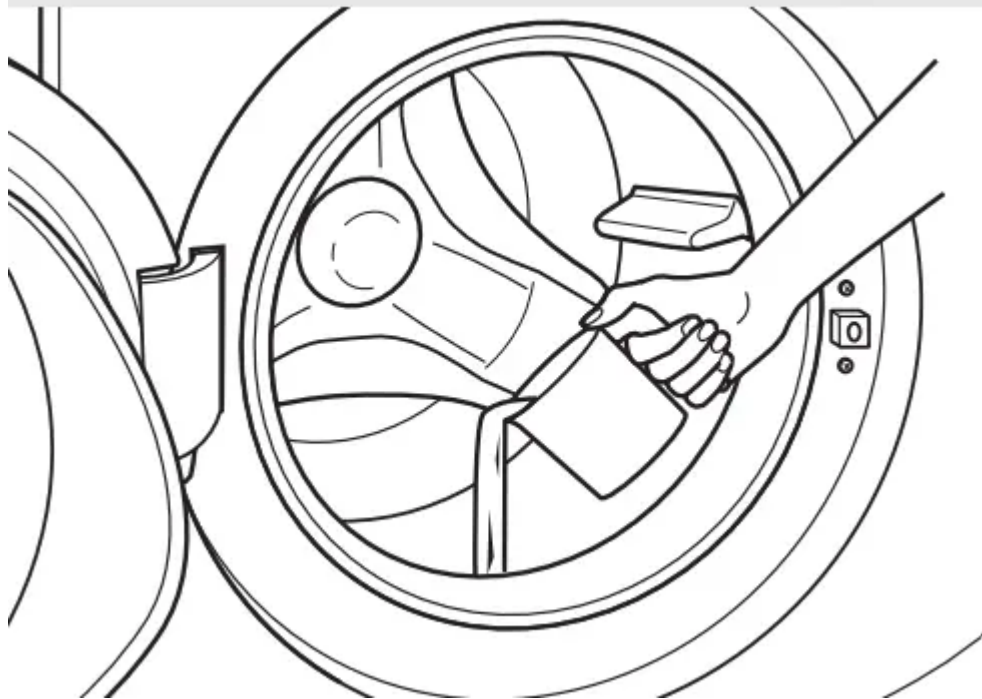

3. Close the door and select the **Basket Clean** cycle. Push the **Start** pad.
4. When the Basket Clean cycle is working, you will see **CLn** on the display. The cycle will complete in about 90 minutes. Do not interrupt the cycle.
5. After the cycle is complete, leave the door open slightly for better ventilation.

If for any reason the cycle needs to be interrupted, the door will not open immediately. Forcing open the door at this stage may cause water to flood.

The door will open after the water is drained to a level where it would not flood the floor.

Basket Clean may be interrupted by pressing the **Start** pad in between cycles. A power outage in the house might also interrupt the cycle. When the power supply is back, the **Basket Clean** cycle resumes where it had stopped. When interrupted, be sure to run a complete

Basket Clean cycle before using the washer. If the **Power** pad is pressed during **Basket Clean**, the cycle will be lost.

IMPORTANT:

- Run **Basket Clean** with 1 Cup (250 ml) of bleach once a month.
- After the completion of a **Basket Clean** cycle, the interior of your washer may have a bleach smell.

- It is recommended to run a light color load after the **Basket Clean** cycle.

Cleaning the Pump Filter

Due to the nature of the front-load washer, it is sometimes possible for small articles to pass to the pump. The washer has a filter to capture lost items so they are not dumped to the drain. To retrieve lost items, clean out the pump filter.

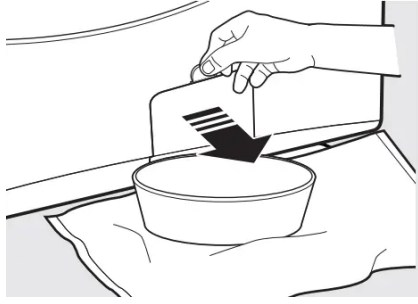

1. Using a coin or flat screwdriver in the notch on the door, open the access door.
2. Place a shallow pan or dish under the pump access door and towels on the floor in front of the washer to protect the floor. It is normal to catch about a cup of water when the filter is removed.

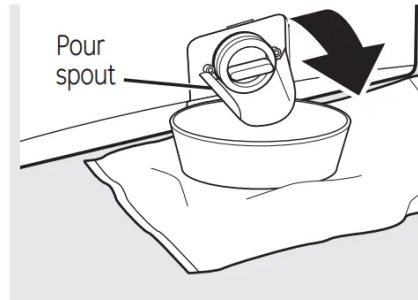

3. Pull down the pour spout.

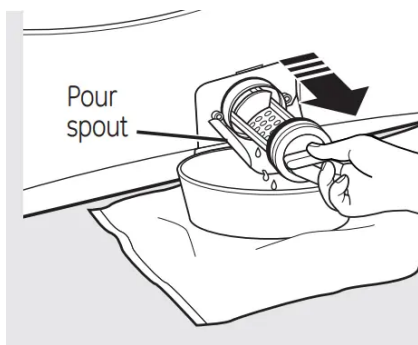

4. Turn the pump filter counterclockwise and remove the filter. Open slowly to allow the water to drain.
5. Clean the debris from the filter.
6. Replace the filter and turn clockwise. Tighten securely.

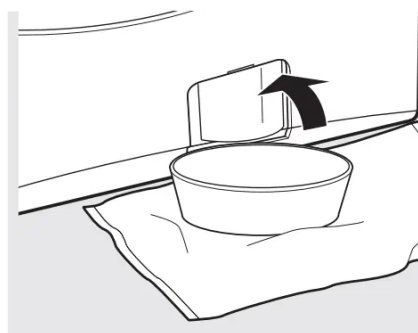

7. Flip up the pour spout.
8. Close the access door.

Cleaning the Door Gasket

	<p>Open the washer door. Using both hands, press down the door gasket. Remove any foreign objects if found trapped inside the gasket. Make sure there is nothing blocking the holes behind the gasket.</p>
	<p>While holding down the door gasket, inspect the interior gasket by pulling it down with your fingers. Remove any foreign objects if found trapped inside this gasket. Make sure there is nothing blocking the holes behind the gasket.</p>

When you are finished cleaning the door gasket, remove your hands and the gasket will return to the operating position.



Tab on back right or left depending on model

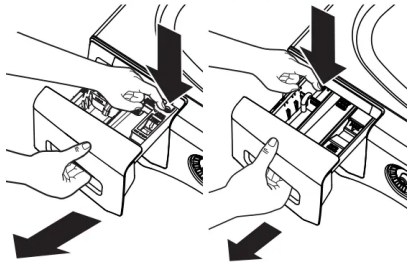

Lock tab is visible only after drawer has been pulled open

Dispenser Drawer Area: Detergent and fabric softener may build up in the dispenser drawer. Residue should be removed once or twice a month.

- Remove the drawer by first pulling it out until it stops. Then reach back into the left or right rear corner (depending on model) of the drawer cavity and press down firmly on the lock tab, pulling out the drawer.

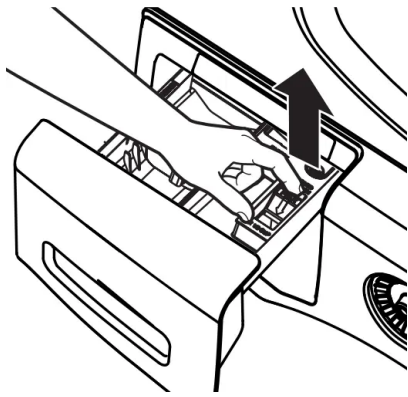

- Remove the inserts from the bleach and fabric softener compartments and the detergent insert. Rinse the inserts and the drawer with hot water to remove traces of accumulated laundry products

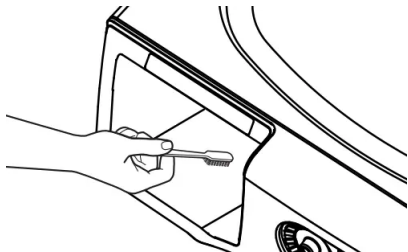

- To clean the drawer opening, use a small brush to clean the recess. Remove all residue from the upper and lower parts of the recess.
- Return inserts to the proper compartments. Replace the dispenser drawer.

TROUBLESHOOTING



Problem	Possible Cause
Not draining Not spinning Not agitating	Load is out of balance
	Pump clogged
	Drain hose is kinked
	Household drain is clogged
	Drain hose siphoning
Leaking water	Door gasket is damaged
	Door gasket not seated
	Check back left corner
	Fill hoses or drain hoses
	Household drain is clogged
	Dispenser clogged
	Incorrect use of detergent
	Dispenser box clogged
Clothes too wet	Load is out of balance



Problem	Possible Cause
	Pump clogged
	Overloading
	Drain hose is kinked
	Household drain is clogged
	Drain hose siphoning
Incomplete cycle or timer not advancing	Automatic load reselect
	Pump clogged
	Drain hose is kinked
	Household drain is clogged
	Drain hose siphoning
Loud or unusual noise; vibration or shaking	Cabinet moving
	All rubber leveling feet are not touching the floor
	Unbalanced load



Problem	Possible Cause
	Pump clogged
No power/washer not working or dead	Washer is unplugged
	Water supply is turned off
	Circuit breaker/fuse
	Automatic self sync
Snags, holes, tears, rips or excessive wear	Overloaded
	Pens, pencils, nails
	Pins, snaps, hooks, pockets
Control time wrong or changes	This is normal
Not enough water	This is normal
Washer pauses or has to be restarted, or washer door is locked and will not open	Pump clogged
Door unlocks or press Start and machine doesn't operate	This is normal
	Incorrect operation



Problem	Possible Cause
Water does not enter washer or enters slowly	Automatic self sy
	Water supply is t
	Water valve scre
	Inlet hose screen
Wrinkling	Improper sorting
	Overloading
	Incorrect wash cy
	Repeated washin



Problem	Possible Cause
Grayed or yellowed clothes	Not enough detergent
	Not using HE (high efficiency) detergent
	Hard water
	Water is not hot enough
	Detergent is not high efficiency
	Dye transfer
Colored spots	Incorrect use of fabric softener
	Dye transfer
Water temperature is incorrect	Water supply is incorrect
	House water heater is set too low
Slight variation in metallic color	This is normal



Problem	Possible Cause
Bad odor inside your washer	Washer unused for long periods of time Used too much detergent
Detergent leak	Incorrect placement of detergent
Improper dispensing of softener or bleach	Dispenser clogged
	Softener or bleach dispenser not working
	Softener or bleach dispenser not properly installed

Warning

This content is compiled from multiple sources and is provided for reference purposes only. It may not be complete or fully applicable to all situations. If you are unable to resolve your issue, please contact the product manufacturer or an authorized service provider for official support.

