

## CONTROL PANEL AND FEATURES

### Model MHW7000A\*

Model MHW7000A\*

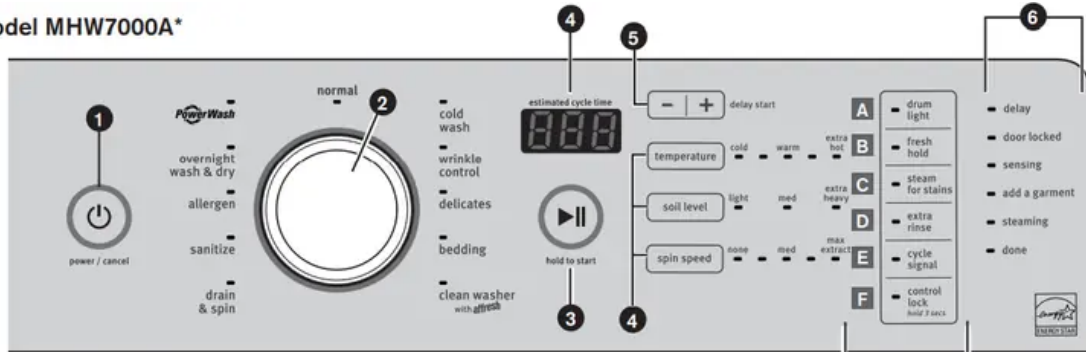

NOTE: The control panel features a sensitive surface that responds to a light touch of your finger. To ensure your selections are registered, touch the control panel with your finger tip, not your fingernail. When selecting a setting or option, simply touch its name.

### Model MHW6000A\*

Model MHW6000A\*

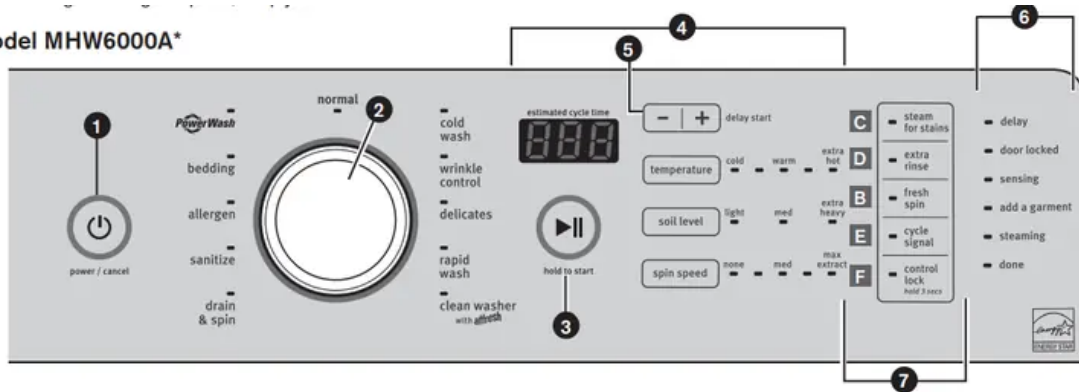

### POWER/CANCEL

- Touch to turn the washer on and off. Touch to stop/cancel a cycle at any time.

### WASH CYCLE KNOB

- Use your Wash Cycle knob to select available cycles on your washer. Turn the knob to select a cycle for your laundry load.
- An LED will light up for the cycle selected.

NOTE: The Clean Washer LED will flash when the washer has run wash cycles as a reminder to run the Clean Washer cycle.

See “Cycle Guide” for detailed descriptions of cycles.

NOTE: For best results when using the Overnight Wash & Dry cycle, use for loads weighing 2.5 pounds and less, such as a soccer uniform or a running tank and shorts.

## START

- Touch and hold until the light above START comes on to start a cycle, or touch once while a cycle is in process to pause it. If you want to add a garment, you can touch START when the “Add a Garment” LED is on.

## LED DISPLAY AND SETTINGS

1. When you select a cycle, its default settings will light up and the
2. Estimated Cycle Time will be displayed. Factors such as load size, wash temperature, and water pressure may affect the time shown in the display during the cycle.
3. Tightly packing garments, unbalanced loads, or excessive suds may cause the washer to adjust the cycle time, as well.
4. Touch the desired option along the right of the display to adjust settings. See “Cycle Guide” for available settings on each cycle.
5. Not all settings are available with all cycles.

## Temperature

1. The recommended wash temperature is preset for each cycle. You may also select a wash temperature based on the type of fabric and soils being washed.
2. For best results, follow the garment label instructions. All wash temperatures feature a cold rinse.

## Soil Level

- The Soil Level setting (wash time) is preset for each wash cycle. For most loads, use this preset soil level. When you change the soil setting, the cycle time will increase or decrease in the Estimated Cycle Time display.
- For heavily soiled and sturdy fabrics, use the Soil Level setting to select more wash time. For lightly soiled and delicate fabrics, use the Soil Level setting to select less wash time. Lower soil level settings will help reduce tangling and wrinkling.

## Spin Speed

- This washer automatically selects the spin speed based on the cycle selected. Some preset speeds can be changed.
- Higher spin speeds mean shorter dry times, but may increase wrinkling in your load. Lower spin speeds reduce wrinkling, but will leave your load more damp.

## OPTIONS

- Touch to activate additional wash options or additional features on the washer. Not all options are available on all models.

### **Drum Light (on some models)**

- Touch and hold to turn on the Drum Light.
- On other models: Touch and hold EXTRA RINSE for seconds to turn on the Drum Light.

### **Fresh Hold® Option (on some models)**

- The Fresh Hold® option will periodically tumble the load after the end of the cycle for up to 12 hours while the integrated fan circulates air through the washer to reduce humidity.
- To turn on the Fresh Hold® option, touch Fresh Hold. If, however, the Fresh Hold® option is turned on, it will stay on for all future cycles until turned back off – the washer remembers the last on/off status set. To turn off the Fresh Hold® option, touch

#### **Fresh Hold.**

1. You may also activate the Fresh Hold® option without running a cycle by touching and holding POWER/CANCEL for one second, then touching and holding Fresh Hold for 3 seconds, then touching and holding START for 3 seconds.
2. To turn off the Fresh Hold® option when it is running, touch

#### **POWER/CANCEL.**

NOTE: The door will lock while the Fresh Hold® option is active. To cancel the option and unlock the door, touch

#### **POWER/CANCEL.**

- Fresh Spin™ Option (on some models)
- The Fresh Spin™ option will periodically tumble the load after the end of the cycle for up to 6 hours to reduce humidity.
- To turn on the Fresh Spin™ option, touch Fresh Spin.
- If, however, the Fresh Spin™ option is turned on, it will stay on for all future cycles until turned back off – the washer remembers the last on/off status set. To turn off the Fresh

#### **Spin™ option, touch Fresh Spin.**

1. You may also activate the Fresh Spin™ option without running a cycle by touching and holding POWER/CANCEL for one second, then touching and holding
2. Fresh Spin for seconds, then touching and holding START for 3 seconds.
3. To turn off the Fresh Spin™ option when it is running, touch

#### **POWER/CANCEL.**

NOTE: The door will lock while the Fresh Spin™ option is active.

- To cancel the option and unlock the door, touch POWER/

## **CANCEL.**

1. Steam for Stains
2. The Steam for Stains option adds additional soak and wash time to many cycles to help remove tough stains, as well as a steam boost for added cleaning power. An integrated heater helps to maintain optimal wash temperatures. See the
3. Cycle Guide” for cycles that allow the Steam for Stains option.

## **Extra Rinse**

- Activate this option to add an extra rinse to most cycles.

NOTE: Some cycles include this feature as a default.

- See “Cycle Guide” for details.

## **Cycle Signal**

- Use this option to turn on or off the signal that sounds at end of cycle.
- To turn off the tones that sound when a setting is touched:
- Touch and hold CYCLE SIGNAL for about 3 seconds.
- Repeat to turn them on.

## **Control Lock**

- Touch and hold for 3 seconds to lock the controls to avoid unwanted changes or operation. Touch and hold 3 seconds again to unlock.
- You can still touch START to pause the cycle, or touch POWER/CANCEL to turn the washer off.

## **DISPENSER DRAWER**

- The dispenser drawer gives you the convenience of automatically adding HE detergent, liquid chlorine bleach, and liquid fabric softener to the wash load at the proper time. See “Using the
- Dispenser Drawer” for information on using the dispenser drawer.
- High Efficiency “HE” detergent compartment
- This compartment holds liquid or powdered HE detergent for your main wash cycle.

### **Liquid fabric softener compartment**

- Automatically dilutes and dispenses liquid fabric softener at the optimum time in the cycle. n Use only liquid fabric softener in this dispenser.

### **Liquid chlorine bleach compartment**

- Automatically dilutes and dispenses liquid chlorine bleach at the optimum time during the first rinse after the wash cycle.

- This compartment cannot dilute powdered bleach.

## HE detergent

- Liquid fabric softener
- Chlorine bleach

## Choosing the Right Detergent

- Use only High Efficiency detergents. The package will be marked
- HE” or “High Efficiency.” Low-water washing creates excessive sudsing with a non-HE detergent. Using non-HE detergent will likely result in longer cycle times and reduced rinsing performance. It may also result in component failure and, over time, buildup of mold or mildew.
- HE detergents are low-sudsing and quick-dispersing to produce the right amount of suds for the best performance. They hold soil in suspension so it is not re-deposited onto clean clothes.
- Follow the manufacturer’s instructions to determine the amount of detergent to use.

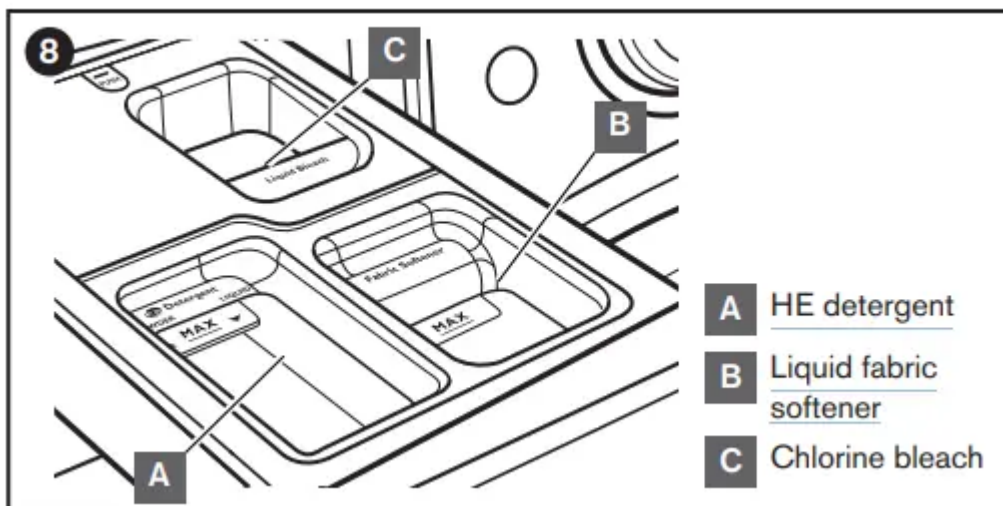

## Delay

- If a Delay Start is set, the Delay indicator will light and the delay time will count down in the display.

## Door Locked

- Door Locked will light to indicate that the door is locked and cannot be opened without first pausing or canceling the cycle.

## Sensing

- When START is touched and held, the washer will first perform a self-test on the door lock mechanism and the sensing light will come on.

- You will hear a click, the drum will make a partial turn, and the door will unlock briefly before locking again.
- Once the door has locked the second time, the washer will begin tumbling and adding water. This sensing process will continue throughout the cycle. You may also hear water flowing through the dispenser, adding detergent to the load.
- After the load size is sensed, the estimated time based on load size will be displayed. The actual cycle time may be lengthened; however, the display will continue to show the estimated time.
- The sensing light will blink once a second at various times during the cycle, such as when the washer is reducing extra suds.

### **Add a Garment**

- When “Add a Garment” is lit, you may pause the washer, open the door, and add items.

### **Steaming**

- This will light to show that the cycle is using a steam boost for added cleaning power.

### **Done**

- Once the cycle is complete, this light will come on. Remove the load promptly for best results. The Done indicator is also lit during
- Fresh Hold® or Fresh Spin™ option.

## **USING THE DISPENSER DRAWER**

### **Open the dispenser drawer.**

1. Add laundry products as described in steps 4–6 in the
2. Using Your Washer” section.
3. Slowly close the dispenser drawer. Make sure it is completely closed.

NOTE: A small amount of water may remain in the dispensers from the previous wash cycle. This is normal.

### **Adding HE detergent to dispenser**

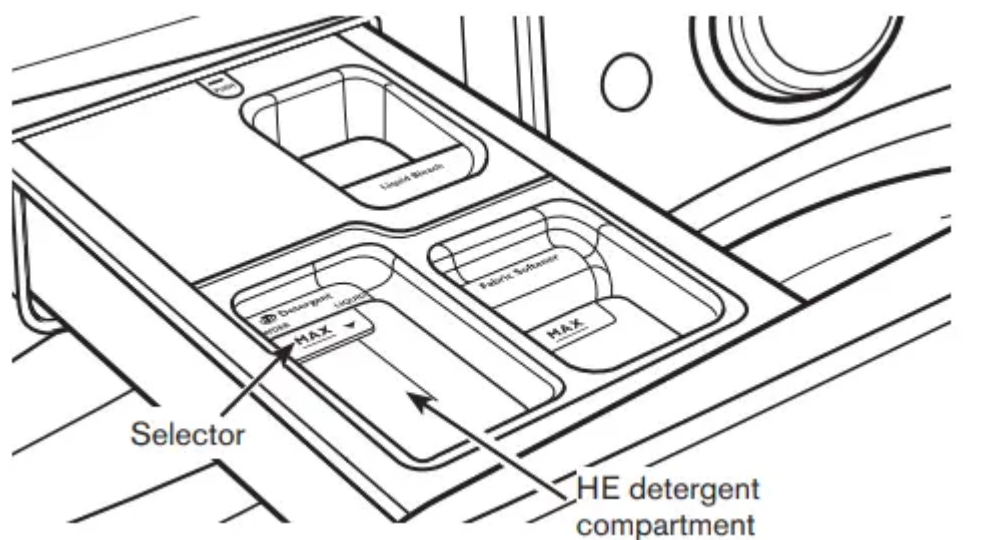

- Pour a measured amount of HE detergent into detergent compartment.
- For powdered detergent, lift the selector to the high position. For liquid detergent, push down the selector to the low position. Use only High Efficiency (HE) detergent.
- Do not overfill; adding too much detergent may cause detergent to be dispensed into the washer too early.







#### IMPORTANT:

- Do not add single-dose laundry packet to dispenser drawer.
- Use powdered detergent when using the Delay Start option.
- Liquid detergent may seep out before the wash begins.

## CYCLE GUIDE







Settings and options shown in bold are default settings for that cycle. For best fabric care, choose the cycle, options, and settings that best fit the load being washed. Not all settings are available with each cycle, and some options cannot be used together.

NOTES: n Not all cycles and options are available on all models n All wash temperature selections feature a cold rinse. n Not all temperatures or spin speeds are labeled on the control panel.

Items to wash using default cycle settings:	Cycle:	Wash Temperature:	Spin Speed:	Soil Level:	Available Options:	Cycle Details:
Normally soiled cottons, linens, sheets, and mixed garment loads	Normal	Extra Hot Hot Warm Cool Cold	Max Extract™ High Med None	Extra Heavy Med Light	Steam for Stains* Fresh Hold®/ Fresh Spin™ Extra Rinse Delay Start	 This cycle combines medium-speed tumbling and an extra-high-speed spin. This cycle is designed to provide the most energy efficiency.
Bright or darkly colored cottons, linens, casual and mixed loads.	Cold Wash	Cold	Max Extract™ High Med None	Extra Heavy Med Light	Fresh Hold®/ Fresh Spin™ Extra Rinse Delay Start	 This cycle uses a concentrated detergent solution along with cold water throughout the cycle to gently lift out stains and care for fabrics.
Lightly soiled shirts, blouses, trousers, pants and dresses	Wrinkle Control	Extra Hot Hot Warm Cool Cold	Max Extract™ High Med Low None	Extra Heavy Med Light	Steam for Stains* Fresh Hold®/ Fresh Spin™ Extra Rinse Delay Start	 This cycle combines low-speed tumbling and low-speed spin for gentle fabric care and reduced wrinkling.
Sheer fabrics, lingerie, sweaters, and lightly soiled shirts, blouses, trousers, pants, and skirts	Delicates	Extra Hot Hot Warm Cool Cold	Max Extract™ High Med Low None	Extra Heavy Med Light	Steam for Stains* Fresh Hold®/ Fresh Spin™ Extra Rinse Delay Start	 This cycle combines low-speed tumbling and low-speed spin for gentle fabric care and reduced wrinkling.
Normally soiled sheets, pillowcases, light blankets, or throws	Bedding	Extra Hot Hot Warm Cool Cold	Max Extract™ High Med Low None	Extra Heavy Med Light	Steam for Stains* Fresh Hold®/ Fresh Spin™ Extra Rinse Delay Start	 The wash action of this cycle is designed to keep large items from tangling and balling up.
Small loads of 3-4 lightly soiled garments	Rapid Wash	Extra Hot Hot Warm Cool Cold	Max Extract™ High** Med Low None	Extra Heavy Med Light	Steam for Stains* Fresh Hold®/ Fresh Spin™ Extra Rinse Delay Start	 For small loads (3-4 items) needed quickly. This cycle combines high-speed tumbling, a shortened wash time, and an extra-high-speed spin for reduced drying times.
No clothes in washer	Clean Washer with affresh®					Use this cycle every 30 washes to keep the inside of your washer fresh and clean. This cycle uses a higher water level. Use with affresh® washer cleaner tablet or liquid chlorine bleach to thoroughly clean the inside of your washer. This cycle should not be interrupted. See "Washer Care." <b>IMPORTANT:</b> Do not place garments or other items in the washer during the Clean Washer with affresh® cycle. Use this cycle with an empty wash tub. See "Washer Care" in "Washer Maintenance."

\* Steam for Stains option is only available when warm, hot or extra hot water temperature is selected.

continued on next page

Items to wash using default cycle settings:	Cycle:	Wash Temperature:	Spin Speed:	Soil Level:	Available Options:	Cycle Details:
Wet load of clothes	Drain & Spin	N/A	Max Extract™ High Med Low None	N/A	Fresh Hold®/ Fresh Spin™ Delay Start	 Use Drain & Spin to remove excess water from the load. Spin speed can be set to a lower setting.
Swimwear, items that need rinsing	Drain & Spin with Extra Rinse	Extra Hot Hot Warm Cool Cold	Max Extract™ High Med Low None	Extra Heavy Med Light	Fresh Hold®/ Fresh Spin™ Delay Start	 Select Drain & Spin; then select Extra Rinse to add water. The cycle includes an extra-high-speed spin. For some fabrics, you may wish to set the spin speed to a lower setting.
Clothing, bedding and towels requiring sanitization	Sanitize†	Extra Hot	Max Extract™ High Med Low None	Extra Heavy Med Light	Steam for Stains* Fresh Hold®/ Fresh Spin™ Extra Rinse Delay Start	 Using the highest wash temperature available ensures sanitization. Check recommended wash temperature of your items.
Sturdy garments and household items exposed to possible allergens	Allergen††	Extra Hot Hot	Max Extract™ High Med	Extra Heavy Med Light	Steam for Stains* Fresh Hold®/ Fresh Spin™ Extra Rinse Delay Start	 Uses more water to flush out allergens such as dust mites and pet dander from normally-soiled items.
2-4 lightly soiled synthetic garments, athletic uniforms, or workout wear	Overnight Wash & Dry	Extra Hot Hot Warm Cool Cold	Max Extract™	Extra Heavy Med Light	Steam for Stains* Fresh Hold® Extra Rinse Delay Start	 This short wash cycle has an extra-high-speed spin followed by intermittent tumbling and fan activation to circulate air through the clothes.
Heavily soiled fabrics	Power Wash	Extra Hot Hot Warm Cool Cold	Max Extract™ High Med Low None	Extra Heavy Med Light	Steam for Stains* Fresh Hold®/ Fresh Spin™ Extra Rinse Delay Start	 Use this cycle for extremely soiled garments and household items that need additional cleaning power. This cycle combines high-speed wash action, medium-speed spin, and a deep rinse to flush excess dirt from the load.

# USING YOUR WASHER

## First wash cycle without laundry

- Before washing clothes for the first time, if not completed during the final installation step, choose the NORMAL cycle and run it without clothes.
- Use only HE detergent. Use 1/2 the manufacturer's recommended amount for a medium-size load. This initial cycle serves to ensure the interior is clean before washing clothes.

## Sort and prepare your laundry

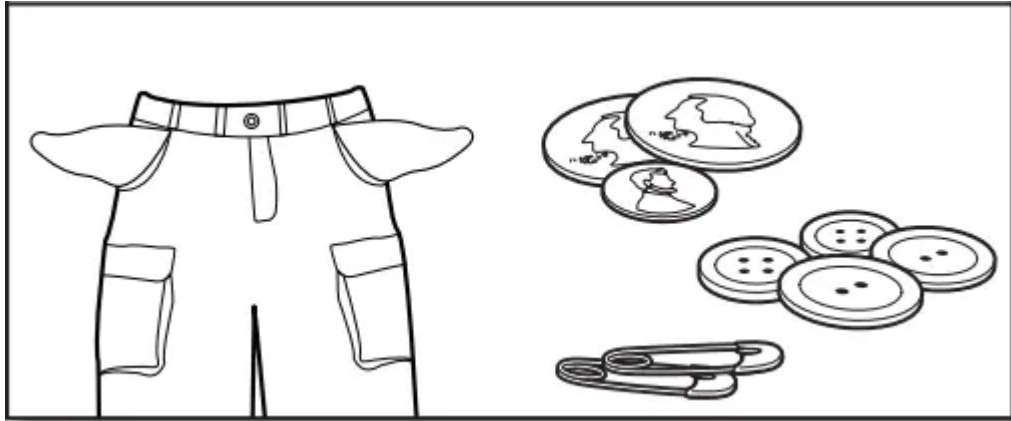

- Empty pockets. Loose change, buttons, or any small object can pass under the washplate and become trapped, causing unexpected sounds.
- Sort items by recommended cycle, water temperature, and colorfastness.
- Separate heavily soiled items from lightly soiled.
- Separate delicate items from sturdy fabrics.
- Do not dry items if stains remain after washing, because heat can set stains into fabric.
- Treat stains promptly.
- Close zippers, fasten hooks, tie strings and sashes, and remove non-washable trim and ornaments.
- Mend rips and tears to avoid further damage to items during washing.

### Helpful Tips:

1. For best performance, use HE liquid detergent when washing bulky items.
2. When washing water-proof or water-resistant items, load evenly. See "Cycle Guide" for tips and more information on using the Bedding cycle.
3. Use mesh garment bags to help avoid tangling when washing delicate or small items.
4. Turn knits inside out to avoid pilling. Separate lint-takers from lint-givers. Synthetics, knits, and corduroy fabrics will pick up lint from towels, rugs, and chenille fabrics. Always read and follow fabric care label instructions to avoid damage to your garments.

### Add laundry products

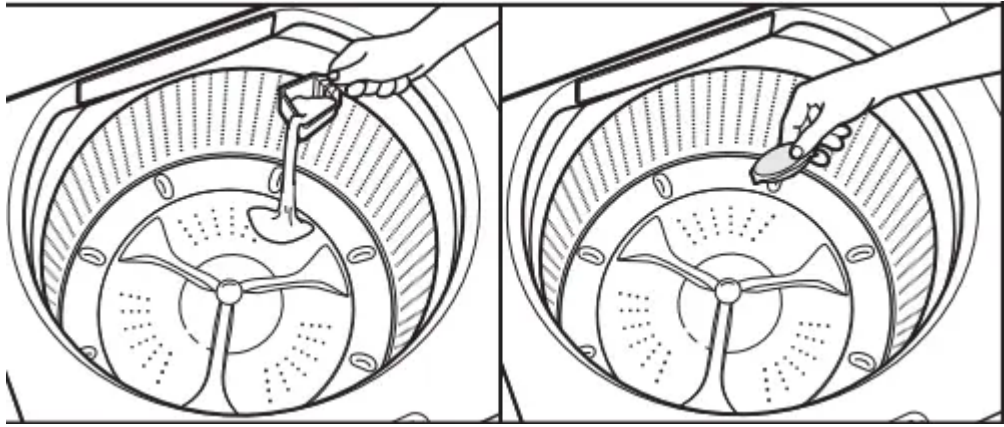

- Single-dose laundry packet, color-safe bleach, or fabric softener crystals can be added to the basket prior to adding laundry.

**NOTE:**

- Do not add clothes to washer basket prior to adding laundry products. Always follow manufacturer's instructions.

**Load laundry into washer**

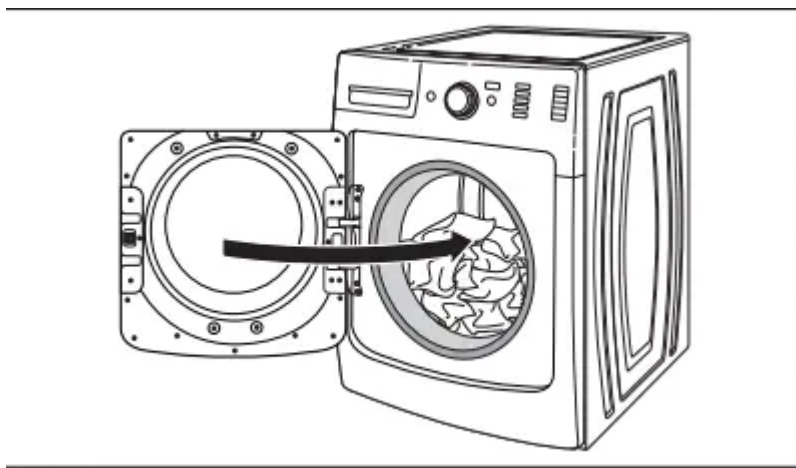

- Place a load of sorted clothes loosely in the washer. Items need to move freely for best cleaning and to reduce wrinkling and tangling.
- Close the washer door by pushing it firmly until the latch clicks. Depending on load type and cycle, the washer can be fully loaded, but not tightly packed. Washer door should close easily.
- See "Cycle Guide" for loading suggestions. n Mix large and small items and avoid washing single items. Load evenly. n Wash small items in mesh garment bags. For multiple items, use more than one bag and fill bags equally

**Add HE detergent**

- Add a measured amount of HE liquid detergent into detergent tray. This tray holds 3 oz. (89 mL).

- If adding powder HE detergent remove inside tray. Do not overfill tray – adding too much detergent may cause detergent to be dispensed into the washer too early.

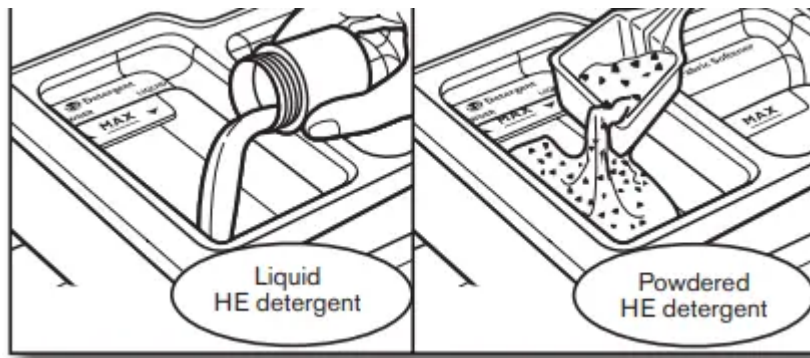

**NOTE:**

- Make sure tray is in drawer when using liquid detergent and removed when using powder detergent. Do not go over the

**Add liquid fabric softener to dispenser (if desired)**

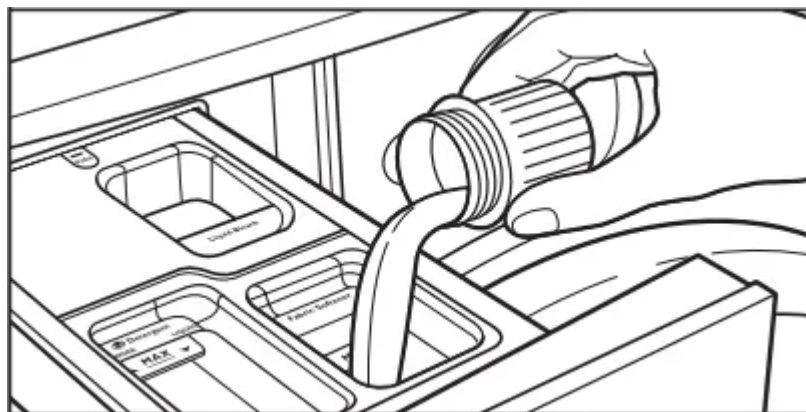

Pour a measured amount of liquid fabric softener into liquid fabric softener compartment. Always follow manufacturer's directions for correct amount of fabric softener based on your load size.

Fabric softener is always dispensed in the last rinse, even if Extra

**Rinse is selected.**

- Do not overfill, dilute, or use more than 1/4 cup (mL) of fabric softener. Do not fill past the MAX line. Overfilling dispenser will cause fabric softener to immediately dispense into washer. n Do not spill or drip any fabric softener onto the clothes. n Do not use liquid fabric softener dispenser balls in this washer.
- They will not dispense correctly

**Add liquid chlorine bleach to dispenser (if desired)**



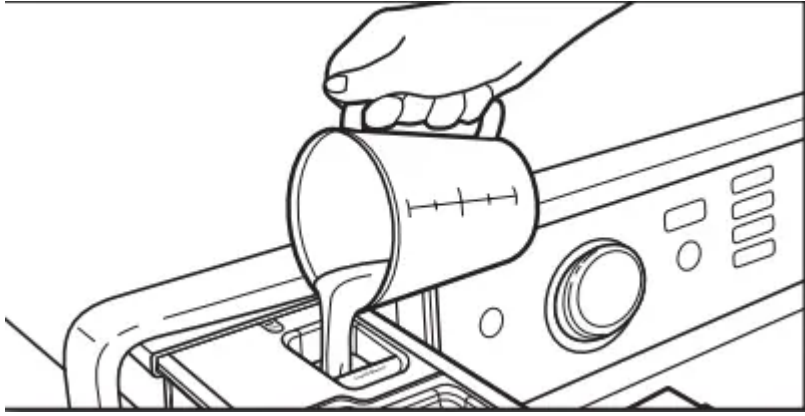

Add liquid chlorine bleach to the bleach compartment. Do not overfill, dilute, or use more than 2/3 cup (165 mL).

Do not use color-safe bleach or Oxi in the same cycle with liquid chlorine bleach.

Always measure liquid chlorine bleach. Use a measuring cup with a pour spout; do not guess. Do not fill beyond the “MAX” level. Overfilling could cause garment damage.

**Max line.**

- Use only High Efficiency detergents. The package will be marked “HE” or “High Efficiency.” Low-water washing creates excessive sudsing with a non-HE detergent. Using nonHE detergent will likely result in longer cycle times and reduced rinsing performance.
- It may also result in component malfunction and, over time, buildup of mold or mildew. HE detergents should be low-sudsing and quick-dispersing to produce the right amount of suds for the best performance. They should hold soil in suspension so it is not redeposited onto clean cloth
- Not all detergents labeled as High Efficiency are identical in formulation and their ability to reduce suds. For example, natural, organic, or homemade HE detergents may generate a high level of suds.
- If you use one of these and see an “F0E2” error code appear in the display, consider using a different HE detergent. Always follow the detergent manufacturer’s instructions to determine the amount of detergent to use. Do not go over the Max line on the dispenser.

**HELPFUL TIP:**

- See “Washer Maintenance” for information recommended method of cleaning washer dispenser trays.

**Add liquid fabric softener or Oxi to dispenser**

- Pour a measured amount of liquid fabric softener or Oxi-type boosters, into tray; always follow manufacturer’s directions for correct amount of fabric softener or Oxi based on your load size. Close dispenser drawer, then select Oxi option.

- Oxi is added during main wash and Fabric Softener is added during rinse. **IMPORTANT:** Oxi option must be selected to ensure proper distribution at correct time in cycle. Do not overfill or dilute. Overfilling dispenser will cause fabric softener to immediately dispense into washer.
- If Extra Rinse option is selected, fabric softener will be dispensed into the last rinse. It is normal for a small amount of water to remain in the dispenser at the end of a cycle.

### **Unlocking the lid to add items**

- If you need to open the lid to add 1 or 2 missed items: Touch the Start/Pause button to pause the washer; the lid will unlock once the washer movement has stopped. This may take several minutes if the load was spinning at a high speed.
- Then close the lid and touch and hold the Start/Pause button again for up to 3 seconds to restart the cycle.

### **IMPORTANT:**

- If the lid is left open for more than 10 minutes the water will pump out and the F8E6 error code will appear on the display.

Remove garments promptly after cycle is finished

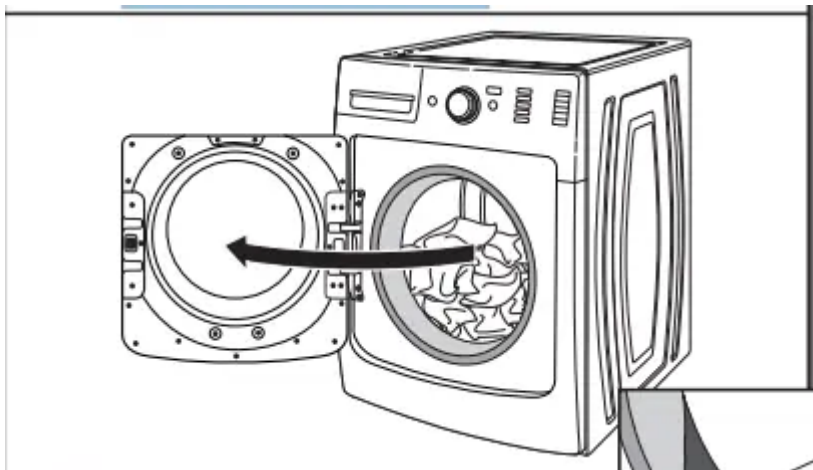

- Promptly remove garments after cycle has completed to avoid odor and rusting of metal objects on garments. When unloading garments, pull back the door seal and check for small items between the tub and the washer drum.
- If you will be unable to remove the load promptly, use the Fresh Hold® or Fresh Spin™ option (depending on model). If selected, the Fresh Hold® option will activate the fan and tumble the load periodically for up to hours. The Fresh Spin™ option will tumble the load periodically for up to 6 hours. To turn off the Fresh Hold® or Fresh Spin™ option, touch

### **POWER/CANCEL.**

- To set the washer so that the Fresh Hold®/
- Fresh Spin™ option does not come on for future cycles, touch Fresh

- Hold® or Fresh Spin™ option.
- NOTE: n The door will remain locked while the Fresh Hold®/Fresh Spin™ option is active. To cancel the option and unlock the door, touch

#### **POWER/CANCEL.**

1. A small amount of water may remain in the dispensers after the wash cycle is complete. This is normal.
2. This washer has a tight seal to avoid water leaks. To avoid odors, leave the door open to allow the washer to dry between uses.

## **WASHER MAINTENANCE**

### **Recommendations to Help Keep Your Washer Clean and Performing at its Best**

- Always use High Efficiency (HE) detergents and follow the
- HE detergent manufacturer's instructions regarding the amount of HE detergent to use. Never use more than the recommended amount because that may increase the rate at which detergent and soil residue accumulate inside your washer, which in turn may result in undesirable odor.
- Use warm or hot water washes sometimes (not exclusively cold water washes), because they do a better job of controlling the rate at which soils and detergent accumulate.
- Always leave the washer door slightly ajar between uses to help dry out the washer and prevent the buildup of
- Cleaning Your Front Loading Washer
- Read these instructions completely before beginning the routine cleaning processes recommended below. This Washer
- Maintenance Procedure should be performed, at a minimum, once per month or every 30 wash cycles, whichever occurs sooner, to control the rate at which soils and detergent may otherwise accumulate in your washer.

### **Cleaning the Door Seal**

- Open the washer door and remove any clothing or items from the washer.
- Inspect the colored seal between the door opening and the drum for stained areas or soil buildup. Pull back the seal to inspect all areas under the seal and to check for foreign objects.
- If stained areas or soil buildup are found, wipe down these areas of the seal using either of the following two procedures: a. affresh® Grit Grabber™ Cloth Procedure: i.
- When the cycle is complete, gently pull back the rubber door seal and clean the entire surface with the rough side of the Grit Grabber™ cloth. b. Dilute Liquid Chlorine Bleach

Procedure: i. Mix a dilute bleach solution, using 3/4 cup (177 mL) of liquid chlorine bleach and 1 gallon (3.8 L) of warm tap water. ii.

- Wipe the seal area with the dilute solution, using a damp cloth. iii. Let stand 5 minutes.
- iv. Wipe down area thoroughly with a dry cloth and let washer interior air dry with door open.

### ***Clean and Performing at Its Best***

1. Always use High Efficiency (HE) detergents and follow the HE detergent manufacturer's instructions regarding the amount of HE detergent to use.
2. Never use more than the recommended amount because that may increase the rate at which detergent and soil residue accumulate inside your washer, which in turn may result in undesirable odor.
3. Use warm and hot wash water settings sometimes (not exclusively cold water washes), because they do a better job of controlling the rate at which soils and detergent accumulate.
4. Always leave the washer lid open between uses to help dry out the washer and prevent the buildup of odor-causing residue.

### ***Cleaning Your Top-Loading Washer***

- Read these instructions completely before beginning the routine cleaning processes recommended below. This Washer
- Maintenance Procedure should be performed, at a minimum, once per month or every 30 wash cycles, whichever occurs sooner, to control the rate at which soils and detergent may otherwise accumulate in your washer.

### ***Cleaning the Inside of the Washer***

- To keep your washer odor-free, follow the usage instructions provided above, and use this recommended monthly cleaning procedure:

### ***Clean Washer Cycle***

- This washer has a special cycle that uses higher water volumes in combination with affresh® Washer Cleaner or liquid chlorine bleach to clean the inside of the washer.

### ***Begin procedure affresh® Washer Cleaner Cycle Procedure***

- Recommended for Best Performance):
- Open the washer lid and remove any clothing or items.
- Place an affresh® Washer Cleaner tablet in the bottom of the washer basket.
- Do not place an affresh® Washer Cleaner tablet in the detergent dispenser.
- Do not add any detergent or other chemical to the washer when following this procedure.
- Close the washer lid.

- Select the Clean Washer cycle.
- Touch and hold the Start/Pause button to begin the cycle.
- The Clean Washer Cycle Operation is described below.

**NOTE:**

- For best results, do not interrupt cycle. If cycle must be interrupted, touch POWER. After the Clean Washer cycle has stopped, run a Rinse & Spin cycle to rinse cleaner from washer.

***Description of Clean Washer Cycle Operation:***

- This cycle will fill to a water level higher than in normal wash cycles to provide rinsing at a level above the water line for normal wash cycle.
- During this cycle, there will be some agitation and spinning to increase the removal of soils.
- After this cycle is complete, leave the lid open to allow for better ventilation and drying of the washer interior.

***Cleaning the Dispensers***

1. After a period of using your washer, you may find some residue buildup in the washer's dispensers. To remove residue from the dispensers, wipe them with a damp cloth and towel dry.
2. Do not attempt to remove the dispensers or trim for cleaning.
3. The dispensers and trim are not removable. If your model has a dispenser drawer, however, remove the drawer and clean it before or after you run the Clean Washer cycle. Use an all-purpose surface cleaner, if needed.

***Cleaning the Outside of the Washer***

- Use a soft, damp cloth or sponge to wipe away any spills.
- Use only mild soaps or cleaners when cleaning external washer surfaces.

**IMPORTANT:** To avoid damaging the washer's finish, do not use abrasive products.

**NON-USE AND VACATION CARE**

1. Operate your washer only when you are home. If moving, or not using your washer for a period of time, follow these steps:
2. Unplug or disconnect power to washer.
3. Turn off water supply to washer to avoid flooding due to water pressure surges.
4. Clean dispensers. See "Cleaning the Dispensers."

**WINTER STORAGE CARE**



**IMPORTANT:** To avoid damage, install and store washer where it will not freeze. Because some water may stay in hoses, freezing can damage washer. If storing or moving during freezing weather, winterize your washer.

*To winterize washer:*

- Shut off both water faucets, disconnect and drain water inlet hoses.
- Put 1 qt. (1 L) of R.V.-type antifreeze in washer drum and run washer on NORMAL cycle for about 2 minutes to mix antifreeze and remaining water.
- Unplug washer or disconnect power.

## **TRANSPORTING YOUR WASHER**

1. Shut off both water faucets. Disconnect and drain water inlet hoses.
2. If washer will be moved during freezing weather, follow

### **WINTER STORAGE CARE directions before moving.**

- Disconnect drain hose from drain system and from back of washer.
- Unplug power cord.
- Place inlet hoses and drain hose inside washer drum.
- Bundle power cord with a rubber band or cable tie to keep it from hanging onto the ground.

**IMPORTANT:**

1. Call for service to install new transport bolts.
2. Do not reuse transport bolts. Washer must be transported in the upright position. To avoid structural damage to your washer, it must be properly set up for relocation by a certified technician.

## **REINSTALLING/USING WASHER AGAIN**

- To reinstall washer after non-use, vacation, winter storage, or moving:
- Refer to Installation Instructions to locate, level, and connect washer.
- Before using again, run washer through the following recommended procedure:
- To use washer again:
- Flush water pipes and hoses. Reconnect water inlet hoses.
- Turn on both water faucets.

## **TROUBLESHOOTING**

### ***Vibration, rocking, or “walking”***

- Feet may not be in contact with the floor and locked.

- Load could be unbalanced.
1. Front and rear feet must be in firm contact with floor, and washer must be level to operate properly. See Installation Instructions.
  2. Washer may not be level. Check floor for flexing or sagging.
  3. If flooring is uneven, a ¾" (19 mm) piece of plywood under your washer will reduce sound. See "Level the Washer" in Installation Instructions.

***Vibration during spinning or washer stopped***

- Load could be unbalanced.
1. Load items in loose heaps evenly around the washplate. Adding wet items to washer or adding more water to basket could unbalance washer.
  2. Avoid washing single items. Balance a single item such as a rug or jeans jacket with a few extra items. Redistribute the load, close the lid, and touch and hold the Start/Pause button.
  3. Use Bedding cycle for oversized, non-absorbent items such as jackets and small comforters.
  4. Item or load not suitable for selected cycle. See "Cycle Guide" and
  5. Using Your Washer" in this Use and Care Guide.

***Clicking or metallic noises***

- Objects may be caught in washer drain system.
  1. Empty pockets before washing. Loose items such as coins could fall between basket and tub or may block pump. It may be necessary to call for service to remove items.
  2. It is normal to hear metal items on clothing such as metal snaps, buckles, or zippers touch against the stainless steel basket.

***Check the following for proper installation:***

- Washer not level.

***Water may splash off basket if washer is not level.***

- Check that load is not unbalanced or tightly packed.

***Fill hoses not attached tightly.***

- Tighten fill-hose connection.

***Fill hose washers. Make sure all four fill hose flat washers are properly seated.***

- Drain hose connection.



***Pull drain hose from washer cabinet and properly secure it to drainpipe or laundry tub. Do not place tape over drain opening.***

- Check household plumbing for leaks or clogged sink or drain.

***Water can back up out of a clogged sink or drainpipe.***

- Check all household plumbing for leaks (laundry tubs, drain pipe, water pipes, and faucets.) Washer not loaded as recommended

**Washer not draining/ spinning, loads are still wet, or spin light remains on (indicating that the washer was unable to pump out water within 10 minutes)**

1. Small items may have been caught in pump or between basket and tub, which can slow draining.
2. Using a cycle with a low spin speed.
3. The washer may be tightly packed or unbalanced
4. Load off balanced.
5. Check plumbing for correct drain hose installation. Drain hose extends into standpipe farther than 4.5" (114 mm).
6. Too much detergent causing suds to slow or stop draining and spinning
  - Empty pockets and use garment bags for small items. Using a cycle with a low spin speed. Cycles with lower spin speeds remove less water than cycles with high spin speeds. Use the recommended cycle/spin speed for your item.
  - To remove extra water in the load, select DRAIN & SPIN. Load may need to be rearranged to allow even distribution of the load in the basket. The washer may be tightly packed or unbalanced.
  - Tightly packed or unbalanced loads may not allow the washer to spin correctly, leaving the load wetter than normal.
  - Evenly arrange the wet load for balanced spinning. Select the Drain & Spin cycle to remove excess water.
  - See "Using Your Washer" for loading recommendations. Load off balanced. See "Vibration or Off-Balance" in the "Troubleshooting" section for more information. Check plumbing for correct drain hose installation.
  - Drain hose extends into standpipe farther than 4.5" (114 mm). Check drain hose for proper installation. Use drain hose form and securely attach to drainpipe or tub. Do not tape over drain opening. Lower drain hose if the end is higher than

Vibration, rocking, or "walking"

- Feet may not be in contact with the floor and locked.
- Washer may not be level.

- Load could be unbalanced or too large
- The shipping bolts are still in the back of the washer.
  - Front and rear feet must be in firm contact with floor, and washer must be level to operate properly. Jam nuts must be tight against the bottom of the cabinet.
  - Check floor for flexing or sagging. If flooring is uneven, a 3/4" (19 mm) piece of plywood under your washer will reduce sound.
  - See "Level the Washer" in Installation Instructions.
  - Avoid tightly packing the load. Avoid washing single items. Balance a single item such as a rug or jeans jacket with a few extra items.
  - Item or load not suitable for selected cycle. See "Cycle Guide" and "Using Your Washer."
  - See "Remove transport bolts from washer" in the Installation Instructions

#### Clicking or metallic noises

- Door locking or unlocking.
- Objects caught in washer drain system
  - The door will lock, unlock, and lock again. You will hear 3 clicks after touching and holding START. This is normal.
  - Empty pockets before washing. Loose items such as coins could fall between washer drum and tub or may block pump. It may be necessary to call for service to remove items.
  - It is normal to hear metal items on clothing such as metal snaps, buckles, or zippers touch against the stainless steel drum.

#### Gurgling or humming

- Washer may be draining water.
  - The pump may make a humming sound with periodic gurgling or surging as final amounts of water are removed during the spin/drain cycles. This is normal at certain stages of the cycle.

#### Rolling or sloshing and occasional clicking (on low-speed spin)

- Steel balls in the balancing system are
  - This is normal at certain stages of the cycle. balancing the load.

#### Check the following for proper installation

- Fill hoses not attached tightly.
- Fill hose washers.
- Drain hose connection.

- Check household plumbing for leaks or clogged sink or drain.
  - Tighten fill-hose connection.
  - Properly seat all four fill-hose flat washers.
  - Check that the drain hose is properly secured to drainpipe or laundry tub.
  - Water can back up out of a clogged sink or drainpipe. Check all household plumbing for leaks (laundry tubs, drain pipe, water pipes, and faucets.)

#### Water or suds leaking from door or rear of cabinet

- Not using HE detergent or using too much HE detergent.
- Residue on door glass.
- Door opened during “Add a Garment.”
  - Only use HE detergent. Suds from regular detergents can cause leaking from the door or rear of cabinet. Always measure detergent and follow manufacturer’s directions based on your load requirements
  - Periodically clean the underside of the glass window to avoid potential leaks
  - Water can drip off the inside of the door when the door is opened after the start of a cycle.

#### Washer won’t run or fill, washer stops working

- Check for proper water supply
  - Both hoses must be attached and have water flowing to inlet valve.
  - Both hot and cold water faucets must be turned on
  - Check that inlet valve screens have not become clogged
  - Check for any kinks in inlet hoses, which can restrict water flow.
- Check proper electrical supply
  - Plug power cord into a grounded 3-prong outlet
  - Do not use an extension cord.
  - Ensure there is power to outlet.
  - Check electrical source or call an electrician to check if voltage is low.
  - Reset a tripped circuit breaker. Replace any blown fuses. NOTE: If problems continue, contact an electrician.
- Normal washer operation.
  - Door must be completely closed and latched for washer to run.
  - Washer will pause during certain phases of cycle. Do not interrupt cycle.



- The washer pauses for about 2 minutes during certain cycles. Allow the cycle to continue. Some cycles feature periods of tumbling and soak.
- Washer may be stopped to reduce suds.
- Cold Wash uses less water in the beginning of the cycle to provide a high concentration of detergent for optimal cleaning action. Following this concentrated tumbling, more water is used to complete the wash.
- The washer door is not firmly shut.
  - The door must be closed during operation
- Washer not loaded as recommended
  - Remove several items, rearrange load evenly in washer drum. Close door and touch and hold START.
  - Do not add more than 1 or 2 additional items after cycle has started to avoid tightly packing or unbalancing.
  - Do not add more water to the washer.

## WARRANTY

1. Commercial, non-residential, multiple-family use, or use inconsistent with published user, operator, or installation instructions.
2. In-home instruction on how to use your product.
3. Service to correct improper product maintenance or installation, installation not in accordance with electrical or plumbing codes, or correction of household electrical or plumbing (i.e. house wiring, fuses, or water inlet hoses).
4. Consumable parts (i.e. light bulbs, batteries, air or water filters, preservation solutions, etc.).
5. Defects or damage caused by the use of non-genuine Maytag parts or accessories.
6. Conversion of your product from natural gas or L.P. gas or reversal of appliance doors.
7. Damage from accident, misuse, abuse, fire, floods, acts of God, or use with products not approved by Maytag.
8. Repairs to parts or systems to correct product damage or defects caused by unauthorized service, alteration, or modification of the appliance.
9. Cosmetic damage including scratches, dents, chips, and other damage to appliance finishes unless such damage results from defects in materials and workmanship and is reported to Maytag within 30 days.

## ASSISTANCE OR SERVICE

- DISCLAIMER OF IMPLIED WARRANTIES IMPLIED WARRANTIES, INCLUDING ANY IMPLIED WARRANTY OF MERCHANTABILITY OR IMPLIED WARRANTY OF FITNESS FOR A PARTICULAR PURPOSE, ARE LIMITED TO ONE YEAR OR THE SHORTEST PERIOD ALLOWED BY LAW.
- Some states and provinces do not allow limitations on the duration of implied warranties of merchantability or fitness, so this limitation may not apply to you. This warranty gives you specific legal rights, and you also may have other rights that vary from state to state or province to province.

### **Warning**

This content is compiled from multiple sources and is provided for reference purposes only. It may not be complete or fully applicable to all situations. If you are unable to resolve your issue, please contact the product manufacturer or an authorized service provider for official support.