

USING THE REFRIGERATOR

About the temperature controls.

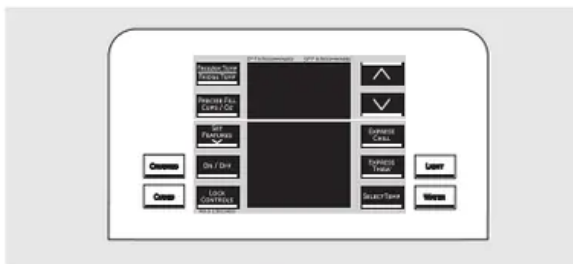

Non-LCD models

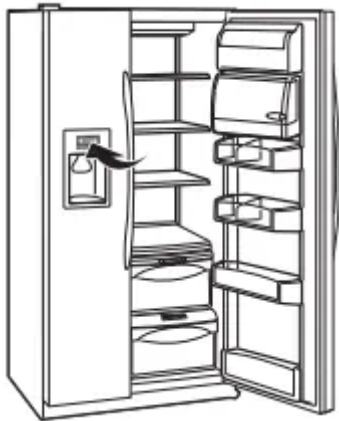
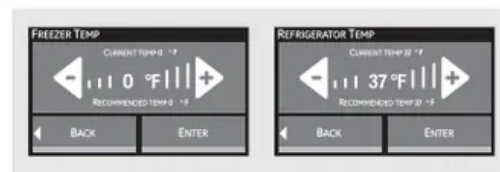

LCD models

NOTE: The refrigerator is shipped with protective film covering the temperature controls. If this film was not removed during installation, remove it now.

*The temperature controls are preset in the factory at **37°F (3°C)** for the refrigerator compartment and **0°F (-18°C)** for the freezer compartment. Allow 24 hours for the temperature to stabilize to the preset recommended settings.*

Refrigerator temperatures can be adjusted between 34°F and 46°F (1°C to 8°C), and the freezer temperatures can be adjusted between -6°F and +8°F (-21°C to -13°C).

To change the Refrigerator temperature:

LCD Models:

Access By: Home > Refrigerator

Activate By: Using the arrows to select the desired temperature. You must press **ENTER** to set the new temperature.

To change the Freezer temperature:

Access By: Home > Freezer

Activate By: Using the arrows to select the desired temperature. You must press **ENTER** to set the new temperature.

Once the desired temperature has been set, the display will return to the **HOME** screen and show the set temperatures underneath the actual temperature display for several seconds. Several adjustments may be required. Each time you adjust the controls, allow 24 hours for the refrigerator to reach the temperature you have set.

Non-LCD Models:

To change the temperature, press and release the **FREEZER TEMP/FRIDGE TEMP** pad. The **SET** light will come on and the display will show the set temperature. To change the temperature, tap either the \vee or \wedge pad until the desired temperature is displayed.

Once the desired temperature has been set, the temperature display will return to the actual refrigerator and freezer temperatures after 5 seconds. Several adjustments may be required. Each time you adjust the controls, allow 24 hours for the refrigerator to reach the temperature you have set.

*The temperature controls can display both the **SET** temperature as well as the actual temperature in the refrigerator and freezer.*

*The actual temperature may vary slightly from the **SET** temperature based on usage and operating environment.*

Turning the cooling system off:

LCD models: Turning the **cooling system OFF** stops cooling in both the freezer and refrigerator compartments, but does not shut off electrical power to the refrigerator.

LCD Models:

Access By: Home > Options > Information and Settings > Cooling System Off

To turn the cooling system back on, press the touch screen and press the **ON** button.

Activate By: Pressing **ENTER**.

Non-LCD Models:

Press and release the **FREEZER TEMP/FRIDGE TEMP** pad. Press \wedge to set freezer temperature to **5**. The display will show **OFF**. To turn the unit back on, press the **FREEZER TEMP/FRIDGE TEMP** pad. Press \vee to set the freezer and refrigerator temperatures to the preset points of 0°F (-18°C) for the freezer and 37°F (3°C) for the refrigerator.

When the unit is turned back on, it will take up to 24 hours to stabilize.

Performance Air Flow System

The Performance Air-Flow System is designed to maximize temperature control in the refrigerator and freezer compartments. This unique special feature consists of the Air Tower along the back wall of the refrigerator and the Air Tunnel on the bottom portion of the freezer rear wall. Placing



food in front of the louvers on these components will not affect performance. Although the Air Tower and the Air Tunnel can be removed, doing so will affect temperature performance. (For removal instructions, on-line, contact us at ge.com or call 800.GE.CARES. In Canada, contact us at geappliances.ca or call 1.800.561.3344.)

About TurboCool.™ (on some models)

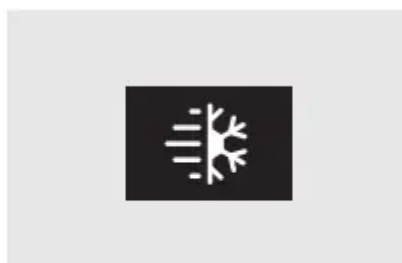

LCD Models Only

How it Works

TurboCool rapidly cools the refrigerator compartment in order to more quickly cool foods. Use TurboCool when adding a large amount of food to the refrigerator compartment, putting away foods after they have been sitting out at room temperature or when putting away warm leftovers. It can also be used if the refrigerator has been without power for an extended period.

Once activated, the compressor will turn on immediately and the fans will cycle on and off at high speed as needed for eight hours. The compressor will continue to run until the refrigerator compartment cools to approximately 34°F (1°C), then it will cycle on and off to maintain this setting. After 8 hours, or if TurboCool is pressed again, the refrigerator compartment will return to the original setting.

How to Use LCD Models:

Access By: Home > Options > Refrigerator Options > TurboCool **Activate By:** Pressing **ON**.

Deactivate By: Pressing **OFF**.

Non-LCD Models:

Press **SET FEATURES**. The refrigerator temperature display will show **TurboCool** and/or **TC**. Press **ON/OFF**.

After **TurboCool** is complete, the refrigerator compartment will return to the original setting.

NOTES:

*The refrigerator temperature cannot be changed during **TurboCool**.*

*The freezer temperature is not affected during **TurboCool**.*

When opening the refrigerator door during **TurboCool**, the fans will continue to run if they have cycled on.

About ClimateKeeper2.™

How it Works

The new ClimateKeeper2™ is the industry's most advanced refrigeration system, delivering optimum temperature and humidity performance to keep food garden fresh longer and reduce freezer burn, while maintaining E star-level efficiency. The new ClimateKeeper2 system features two evaporators—one for the refrigerator and one for the freezer. This provides two separate cooling systems for the entire unit, and separates the airflow between the fresh food and freezer sections during normal cooling operations.*

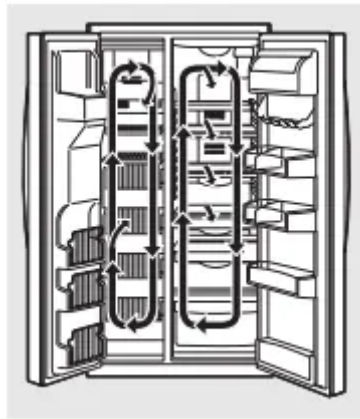

This ensures that the humidity levels in the fresh food compartment are significantly higher than in a conventional system,** allowing fresh produce and other unsealed foods to retain their moisture content and freshness longer.

Moisture sensitive foods such as fresh fruit, salads, rice, etc., can now be stored on open shelves without excessive moisture loss.

Due to the higher humidity in the refrigerator, you may on occasion experience fog or small amounts of moisture in the refrigerator compartment. This is normal and may come and go as different food loads and environmental conditions change. Wipe dry with a paper towel if desired.

The separate airflow system minimizes the mixing of air between the two compartments, which reduces fresh food odor transfer to improve the taste of ice.

The ClimateKeeper2™ system also reduces the number of defrosting cycles in the freezer evaporator, thereby reducing freezer burn.

*Freezer air is used in the CustomCool™ feature.

**Testing shows a higher level of humidity in the Fresh Food section in Climate Keeper2™ refrigerators versus conventional units.

About CustomCool™ (on some models.)

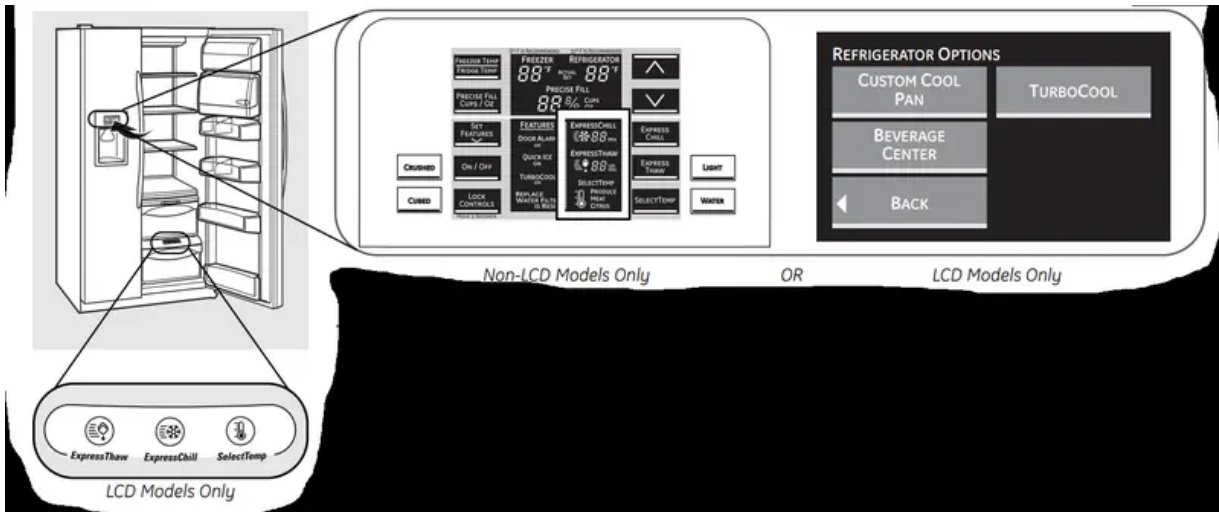

How it Works

The **CustomCool™** feature is used to quickly chill items, thaw items or hold the pan at a specific temperature. This feature is a system of dampers, a fan, a temperature thermistor and a heater.

The pan is tightly sealed to prevent temperature fluctuations in the rest of the refrigerator. The controls for this pan are located on the dispenser with the temperature controls.

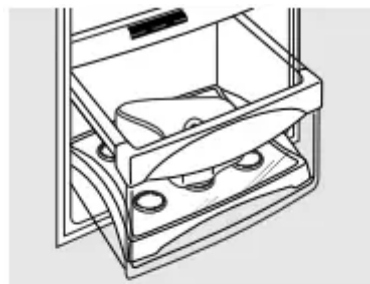

ExpressThaw™

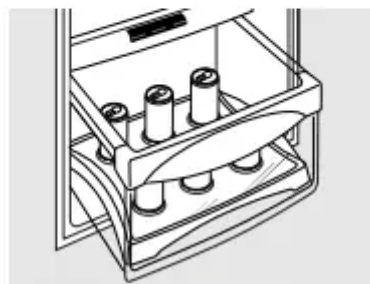

ExpressChill™

How to Use

1. Empty the pan. Place the Chill/Thaw tray in the pan. Place the items on the tray and close the pan completely.
2. **LCD Models:**

Access by: Home > Options > Refrigerator Options > CustomCool Pan

Non-LCD Models: Select the ExpressThaw™, ExpressChill™ or SelectTemp™ pad. The display and SET light will come on. Tap the pad until the light appears next to the desired setting. Use the following chart to determine the best setting to use.

- ExpressChill can be set to 15, 30 or 45 minutes. The default is 15 minutes.
- To stop a feature before it is finished:

For LCD Models:

Go into that feature's menu and press the OFF button.

For Non-LCD Models:

Tap that feature's pad until no options are selected and the display is off.

- During ExpressThaw and ExpressChill, the display on the controls will count down the time in the cycle (on some models).
- After the ExpressThaw cycle is complete, the pan will reset to the MEAT setting (32°F [0°C]) to help preserve thawed items until they are used.
- The displayed actual temperature of the CustomCool pan may vary slightly from the SET temperature based on usage and operating environment.

NOTE: For food safety reasons, it is recommended that foods be wrapped in plastic wrap when using ExpressThaw. This will help contain meat juices and improve thawing performance.

How to Remove and Replace the Drawer

To remove:

1. Pull the drawer out to the stop position.
2. Rotate all four swing locks to the unlock position.
3. Lift the front of the drawer up and out.

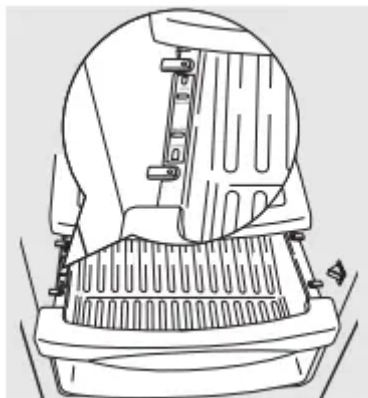

To replace:

1. Make sure all four swing locks are in the unlock position.



2. Place the sides of the drawer into the drawer supports, making sure the swing locks fit on the drawer slots.
3. Lock all four swing locks by rotating them to the lock position.

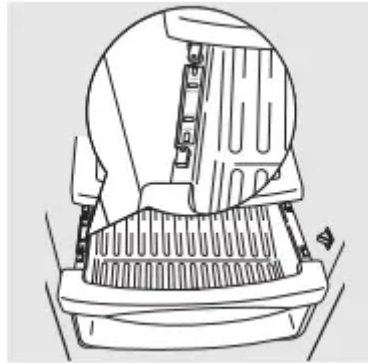

How to Use the Beverage Center (LCD models only)

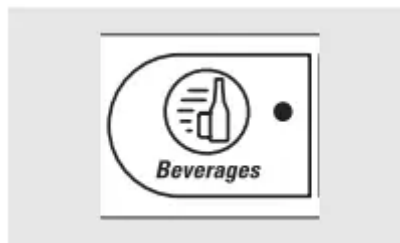

Some **CustomCool** models feature a beverage center. It is designed to store beverages at colder temperatures. Select this feature if you like to keep extra-chilled refreshments on hand.

Access by: Home > Options > Refrigerator Options > Beverage Center **Activate by:** Pressing **ON**.

Deactivate by: Pressing **OFF**.

How to Remove and Replace the Beverage Center (Icd models only)

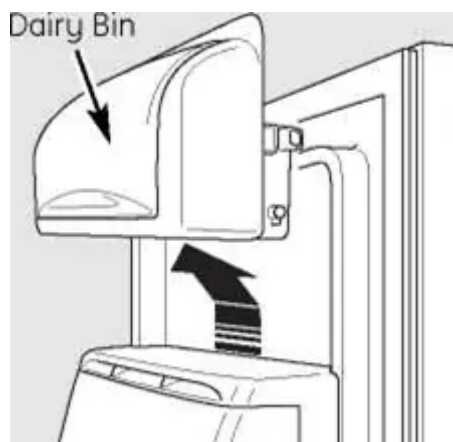

To remove:

1. Remove dairy bin first. Holding the bottom of the dairy bin, lift the front straight up, then lift up and out.
2. Holding left and right side of beverage center, lift straight up and out.
3. Leave adapter in place.

To replace:

1. Engage backside of beverage center in molded supports on adapter. Then push down on the sides of the beverage center. The beverage center will lock into place.
2. Replace dairy bin

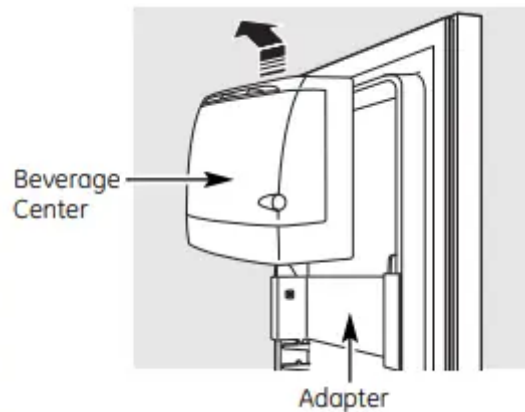

About QuickFreeze.™(on some models)

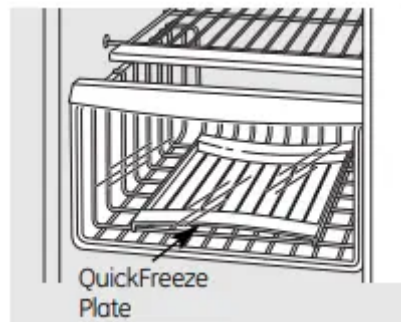

The **QuickFreeze** plate is only to be used with the **QuickFreeze** feature.

Use **QuickFreeze** to freeze items faster to enhance food preservation.

How to Use

Place food (wrapped in plastic wrap) on **QuickFreeze** plate. Turn the feature on via the LCD controls.

Some LCD Models Only:

Access By: Home > Options > Freezer Options > QuickFreeze

Activate By: Using the arrows to select the time and pressing **Enter**.



Deactivate By: Pressing **OFF**.

NOTE: While the **QuickFreeze** feature is enabled, the actual freezer temperature may drop as low as -3°F (-19°C). This is normal.

About the water filter. (On some models.)

Water Filter Cartridge

The water filter cartridge is located in the back upper right corner of the refrigerator compartment.

When to Replace the Filter

LCD Models:

A pop-up screen will appear on the LCD screen to remind you to replace the water filter. You can check the status of the water filter manually. Access By: Home > Options > Dispenser Options > Reset Water Filter

Non-LCD Models:

There is a replacement indicator light for the water filter cartridge on the dispenser. This light will turn orange to tell you that you need to replace the filter soon.

The filter cartridge should be replaced when the replacement indicator light turns red or if the flow of water to the dispenser or icemaker decreases.

Removing the Filter Cartridge

If you are replacing the cartridge, first remove the old one by slowly turning it to the left. Do not pull down on the cartridge. A small amount of water may drip down.

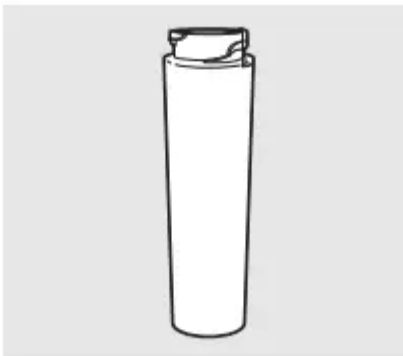

Installing the filter cartridge

1. There is an adapter attached to the top of the new filter cartridge. The adapter must be removed before installing the cartridge. To remove the adapter, turn it to the left about 1/4 turn.
2. Fill the replacement cartridge with water from the tap to allow for better flow from the dispenser immediately after installation.
3. Line up the arrow on the cartridge and the cartridge holder. Place the top of the new cartridge up inside the holder. Do not push it up into the holder.

4. Slowly turn it to the right until the filter cartridge stops. **DO NOT OVERTIGHTEN.** As you turn the cartridge, it will automatically raise itself into position. The cartridge will rotate about 1/2 turn.

5. Run water from the dispenser for 5 minutes to clear the system and prevent sputtering.

6. **LCD Models:**

Press **FILTER REPLACED** button to confirm replacement.

Non-LCD Models:

Press the **SET FEATURES** pad until **REPLACE WATER FILTER** is lit. Press and hold the **ON/OFF** pad for 3 seconds. **WATER FILTER IS RESET** will show in the window.

NOTE: A newly installed water filter cartridge may **cause water to spurt from the dispenser.**

Filter Bypass Plug

You must use the filter bypass plug when a replacement filter cartridge is not available.

The dispenser and the icemaker will not operate without the filter or filter bypass plug.

Replacement Filters: To order additional filter cartridges in the United States, visit our Website, ge.com, or call GE Parts and Accessories, 800.626.2002.

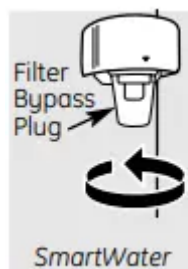
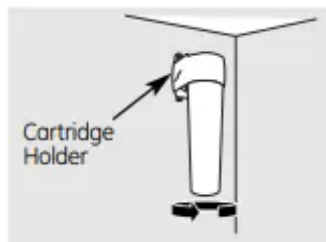

Shelves and Bins

Not all features are on all models.

Refrigerator Door Bins and Freezer Door Tilt-Out Bins

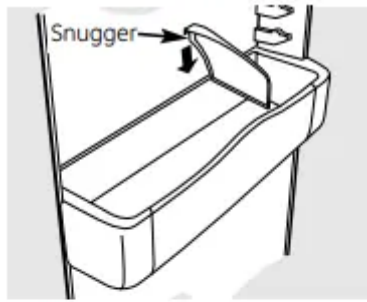

Refrigerator bin

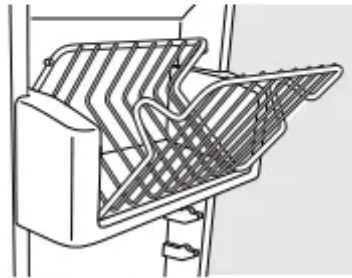

Freezer tilt-out bin

Bins

The larger refrigerator door bins and freezer tilt-out door bins are adjustable.

To remove: Lift the front of the bin straight up, then lift up and out.

To replace or relocate: Engage the back side of the bin in the molded supports of the door. Then push down on the front of the bin. Bin will lock in place.

The snagger helps prevent tipping, spilling or sliding of small items stored on the door shelf. Place a finger on either side of the snagger near the rear and move it back and forth to fit your needs

Top Freezer Bins

CAUTION: Be careful when placing items in the top bin. Make sure that items do not block or fall into the ice chute

CAUTION: Part must be in place as shown for proper ice dispensing. Food cannot be stored in this location

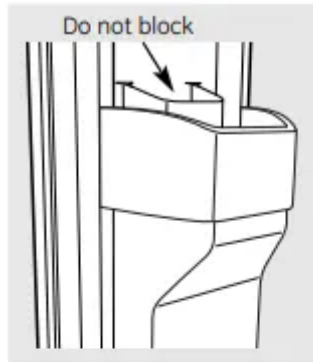

Top freezer bin

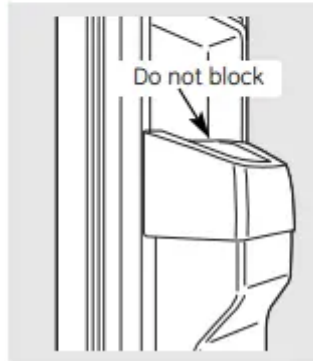

Top freezer bin (on some models)

Slide-Out Shelf (on some models)

The slide-out shelf allows you to reach items stored behind others. The special edges of the spillproof shelf are designed to help prevent spills from dripping to lower shelves.

Spillproof Shelf

To remove: Slide the shelf out until it reaches the stop, then press down on the tab and slide the shelf straight out.

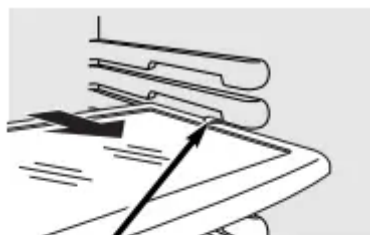

Press tab and pull shelf forward to remove

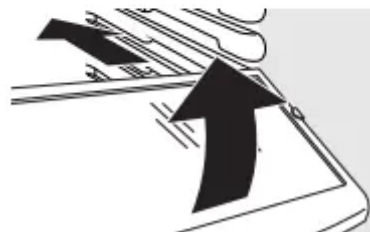

To replace or relocate: Line the shelf up with the supports and slide it into place. The shelf can be repositioned when the door is at 90° or more. To reposition the shelf, slide the shelf past the stops and angle downward. Slide shelf down to the desired position, line up with the supports and slide into place. Make sure you push the shelves all the way back in before you close the door.

QuickSpace™ Shelf

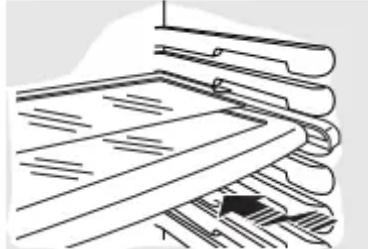

This shelf splits in half and slides under itself for storage of tall items on the shelf below. This shelf can be removed and replaced or relocated just like the Slide-Out Spillproof Shelves.

On some models, this shelf cannot be used in the lowest position.

Freezer Baskets

To remove, push the basket all the way to the back of the freezer. Lift up until the back pins are disengaged. Lift the entire basket up and pull out.

Make sure you push the baskets all the way back in before you close the door.

Slide-Out Freezer Shelves

To remove, slide out to the stop position, lift the front past the stop position, and slide out from rib.

Make sure you push the shelves all the way back in before you close the door.

Fixed Freezer Shelves

There are two types of fixed freezer shelves.

To remove this type of shelf:

1. Lift the shelf up at the left side.
2. Bring the shelf out.

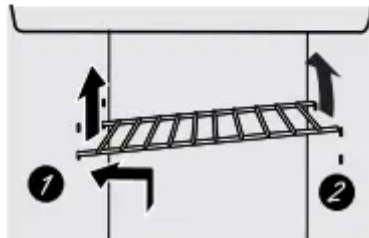
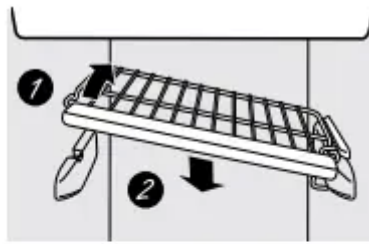

To remove this type of shelf:

1. Lift up the left side of the shelf and slide it left into the center of the shelf supports.
2. Rotate the right side of the shelf up and out of the shelf supports.

NOTE FOR DISPENSER MODELS: In order to take full advantage of the tilt-out ice bin, only store items on the shelf below the ice bin that are no taller than the lowest point on the bin.

Door Wine/Beverage Rack (on some models)

This rack holds up to 5 cans, one bottle of wine or one 2-liter bottle of soda.

The rack hangs from the sides of the dairy bin.

To remove:

1. Empty the wine/beverage rack.
2. Holding the bottom of the dairy bin, lift the front straight up, then lift up and out.
3. To detach the rack from the dairy bin, pull the rack's side wires out of the holes on each side of the dairy bin.

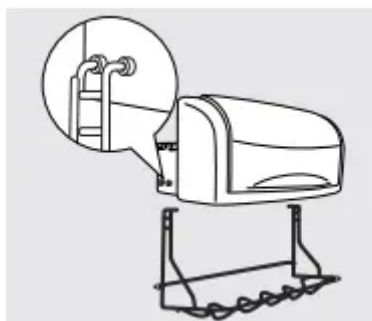

To replace:

1. Reattach the rack to the sides of the bin.

2. Engage the back side of the bin in the molded supports on the door. Then push down on the front of the bin. The bin will lock into place.

About the refrigerator doors.

Refrigerator Doors

The refrigerator doors may feel different than the ones you are used to. The special door opening/closing feature makes sure the doors close all the way and are securely sealed.

When opening and closing the door you will notice a stop position. If the door is opened past this stop point, the door will remain open to allow you to load and unload food more easily. When the door is only partially open, it will automatically close.

The resistance you feel at the stop position will be reduced as the door is loaded with food.

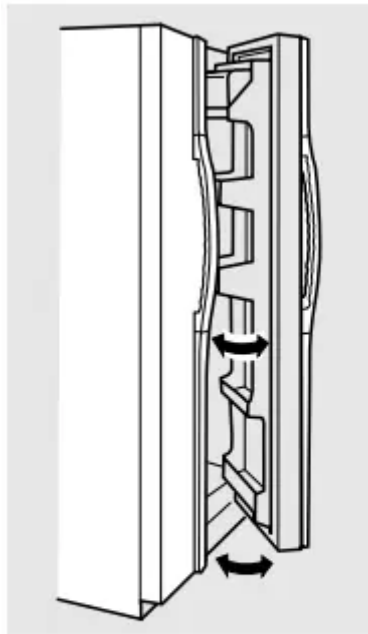

When the door is only partially open, it will automatically close.

*Beyond this **stop** the door will stay open.*

Door Alignment

If doors are uneven, adjust the refrigerator door.

To remove the base grille, open the doors, remove the screw at each end of the base grille and then pull the grille straight out.

1. Using a 7/16" socket wrench, turn the door adjusting screw to the right to raise the door; to the left, to lower it. (A nylon plug, imbedded in the threads of the pin, prevents the pin from turning unless a wrench is used.)
2. After one or two turns of the wrench, open and close the refrigerator door and check the alignment at the top of the doors.

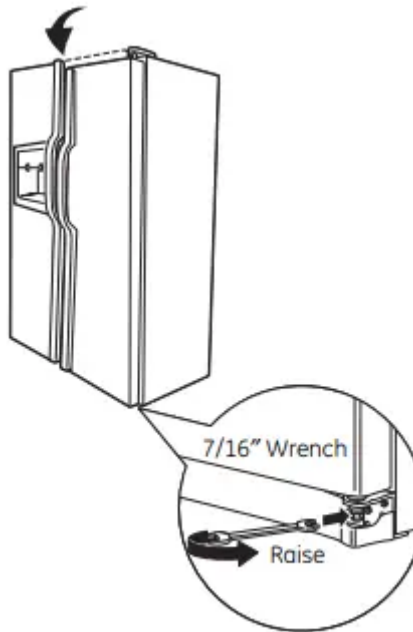

About the crispers and pans.

Not all features are on all models.

Fruit and Vegetable Crispers

Excess water that may accumulate in the bottom of the drawers should be wiped dry.

On some models, the bottom drawer has full extension slides that allow full access to the drawer.

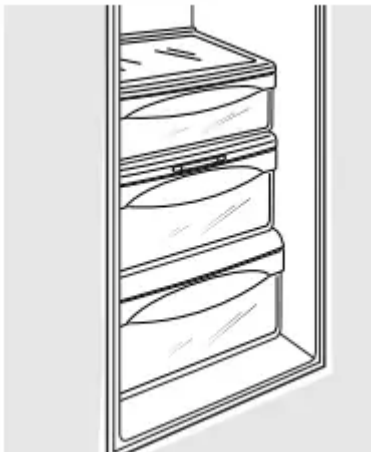

Adjustable Humidity Crispers

Slide the control all the way to the HI setting to provide high humidity recommended for most vegetables.

Slide the control all the way to the LO setting to provide lower humidity levels recommended for most fruits.

Convertible Deli Pan

The convertible deli pan has its own cold air duct to allow a stream of cold air from the freezer compartment or refrigerator compartment to flow to the pan.

The variable temperature control regulates the air flow from the Climate Keeper.

Set the control to the coldest setting to store fresh meats.

Set the control to cold to convert the pan to normal refrigerator temperature and provide extra vegetable storage space. The cold air duct is turned off. Variable settings between these extremes can be selected.

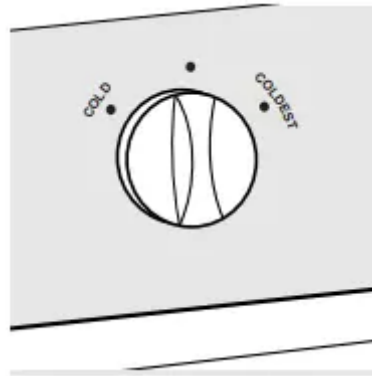

About crisper removal.

Crisper Removal

Crispers can easily be removed by pulling the drawer straight out and lifting the drawer up and over the stop location.

If the door prevents you from taking out the drawers, first try to remove the door bins. If this does not offer enough clearance, the refrigerator will need to be rolled forward until the door opens enough to slide the drawers out. In some cases, when you roll the refrigerator out, you will need to move the refrigerator to the left or right as you roll it out.

About the automatic icemaker.

Not all features are on all models.

**On dispenser models,
to access ice or reach
the power switch:**

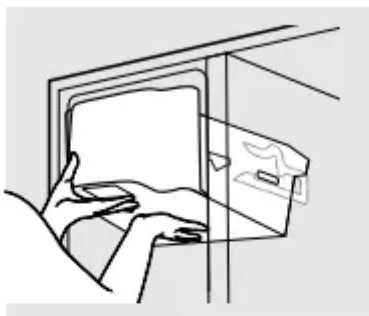

1 Lift the bin, then pull it forward until the bin stops.

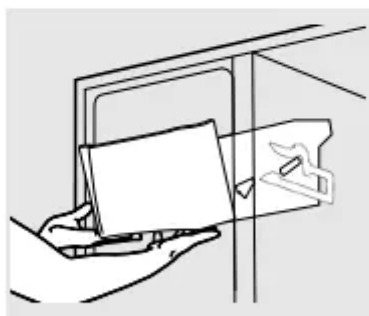

2 Lower the bin to access ice or reach the power switch.

NOTE: In order to take full advantage of the tilt-out ice bin, only store items on the shelf below the ice bin that are no taller than the lowest point on the bin.

Automatic Icemaker

The icemaker will produce seven cubes per cycle- approximately 100-130 cubes in a 24-hour period, depending on freezer compartment temperature, room temperature, number of door openings and other use conditions.

If the refrigerator is operated before the water connection is made to the icemaker, set the power switch in the OFF position.

When the refrigerator has been connected to the water supply, set the power switch to the ON position.

The icemaker will fill with water when it cools to 15°F (-10°C). A newly installed refrigerator may take 12 to 24 hours to begin making ice cubes.

You will hear a buzzing sound each time the icemaker fills with water.

Throw away the first few batches of ice to allow the water line to clear.

Be sure nothing interferes with the sweep of the feeler arm.

When the bin fills to the level of the feeler arm, the icemaker will stop producing ice. It is normal for several cubes to be joined together.

If ice is not used frequently, old ice cubes will become cloudy, taste stale and shrink.

Special note about dispenser models:

- Dispenser models have a tilt-out ice bin. The bin can be tilted out as shown in the illustrations, and it will hold itself up while you take ice out or turn the icemaker power switch on and off. Be sure to put the bin back in place before closing the door.
- To restore your ice level from an empty bucket stage, the following steps are recommended:

1. 12 hours after the first batch of ice has fallen into the bin, dispense 3 to 4 cubes.
2. After an additional 6 hours, dispense 3 to 4 cubes again.

These steps will restore your ice level in the shortest amount of time.

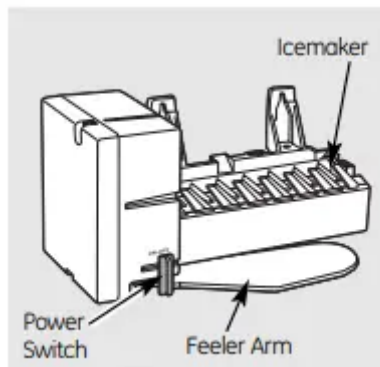

Removing Ice Bin (dispenser models)

CAUTION: The ice bin is heavy when full. Set the power switch to the OFF position before removing the bin.

When replacing the bin, be sure to press it firmly into place. If it does not go all the way back, remove it and rotate the drive mechanism 1/4 turn. Then push the bin back again.

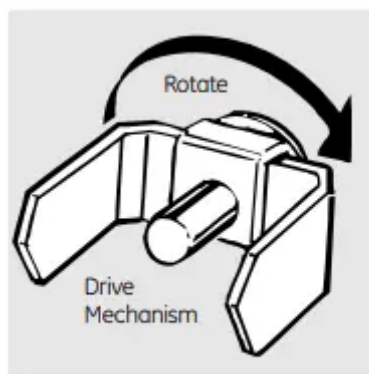

Dispenser Models only

1. Lift the bin, then pull it forward until the bin stops.



2. Lift and pull forward again to remove the bin.

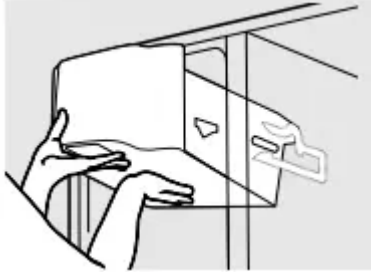

About the ice and water dispenser(on some models.)

To Use the Dispenser

Select CUBED ICE, CRUSHED ICE or WATER.

Press the glass gently against the top of the dispenser cradle.

The spill shelf is not self-draining. To reduce water spotting, the shelf and its grille should be cleaned regularly.

If no water is dispensed when the refrigerator is first installed, there may be air in the water line system. Press the dispenser arm for at least two minutes to remove trapped air from the water line and to fill the water system. To flush out impurities in the water line, throw away the first six glassfuls of water.

CAUTION: Never put fingers or any other objects into the ice crusher discharge opening.

Locking the Dispenser

Press the LOCK pad for 3 seconds to lock the dispenser and control panel. To unlock, press and hold the pad again for 3 seconds.

Dispenser Light

The LIGHT pad turns the night light in the dispenser on and off. The light also comes on when the dispenser cradle is pressed. On some models, if this light burns out, it should be replaced with a 6 watt 12V maximum bulb.

Door Alarm Use

Door Alarm to sound if either door is open for more than 3 minutes. The alarm will stop once the door is closed. For LCD models, a popup screen will appear. The alarm can be silenced by touching the LCD screen.

Quick Ice

When you need to speed up ice production, use the Quick Ice feature. While this feature is turned on, the freezer fan runs continuously for 48 hours, or until the feature is turned OFF. During this period, ice production will increase up to 40%. Models with the integrated ice feature system require at FIRST USE at least half an 8 oz. glass of ice to be dispensed

every 6 to 12 hours. This will help the icemaker fill the bucket properly so that dispensing is better.

How to Use

LCD Models: Access by: Home > Options > Freezer Options > Quick Ice

Activate by: Pressing ON.

Deactivate by: Pressing OFF.

Non-LCD Models: Press the SET FEATURES pad twice and QUICK ICE will blink. Press ON/OFF to turn the feature on, then again to turn it off.

Precise Fill

This water dispenser is equipped with a feature called “precise fill.” This feature allows you to choose a precise amount of water (cups or ounces) that you would like dispensed. Pints and Liters are also available for LCD models.

LCD Models

Access By: Home > Options > Dispenser Options > Precise Fill > Set Amount

Activate By: Using the arrow buttons to select the desired amount. Press MORE UNITS to select between CUPS, OUNCES, PINTS or LITERS.

Non-LCD Models

1. Press the PRECISE FILL CUPS/OZ pad. The WATER pad will light and the CRUSHED and CUBED ice pads will turn off. The last unit used will be displayed.
2. Press the PRECISE FILL pad again to toggle between cups and ounces.

If you selected OUNCES, press the \vee or \wedge pad to select the number of ounces you would like to have dispensed between 2–99 ounces. The default is 8 ounces.

If you selected CUPS, press the \vee or \wedge pad to select the amount you would like to have dispensed. They are displayed as $1/4$, $1/3$, $1/2$, $2/3$ and $3/4$, with the highest amount being $16\ 3/4$ cups. The default is 1 cup.

3. Press the cup against the cradle and water will begin dispensing. It will automatically stop when the amount set has been dispensed. The display will show the amount of water dispensed, beep, then reset after 5 seconds.

NOTE: Do not leave the dispenser unattended when water is being dispensed.

4. If you would like to stop dispensing water before the specified amount has been dispensed, just remove the cup from the cradle. The display will show the amount that has been dispensed for 5 seconds. If the cup switch is pressed again within that time, the dispenser will continue up to the set amount. If not, the display will return to the set amount.

Important Facts About Your Dispenser

- Do not add ice from trays or bags to the storage drawer. It may not crush or dispense well.
- Avoid overfilling glass with ice and use of narrow glasses. Backed-up ice can jam the chute or cause the door in the chute to freeze shut. If ice is blocking the chute, poke it through with a wooden spoon.
- Beverages and foods should not be quick-chilled in the ice storage drawer. Cans, bottles or food packages in the storage drawer may cause the icemaker or auger to jam.
- To keep dispensed ice from missing the glass, put the glass close to, but not touching, the dispenser opening.
- Some crushed ice may be dispensed even though you selected CUBED ICE. This happens occasionally when a few cubes accidentally get directed to the crusher.
- After crushed ice is dispensed, some water may drip from the chute.
- Sometimes a small mound of snow will form on the door in the ice chute. This condition is normal and usually occurs when you have dispensed crushed ice repeatedly. The snow will eventually evaporate.

Care and Cleaning

Cleaning the Outside

The dispenser drip area, beneath the grille, should be wiped dry. Water left in this area may leave deposits. Remove the deposits by adding undiluted vinegar to the well. Soak until the deposits disappear or become loose enough to rinse away.

The dispenser cradle. Before cleaning, lock the dispenser by pressing and holding the LOCK pad for 3 seconds. Clean with warm water and baking soda solution— about a tablespoon (15 ml) of baking soda to a quart (1 liter) of water. Rinse thoroughly and wipe dry.

The door handles and trim. Clean with a cloth dampened with soapy water. Dry with a soft cloth.

The stainless steel panels and door handles (on some models) can be cleaned with a commercially available stainless steel cleaner. A spray-on stainless steel cleaner works best.

Do not use appliance wax or polish on the stainless steel.

Keep the outside clean. Wipe with a clean cloth lightly dampened with kitchen appliance wax or mild liquid dish detergent. Dry and polish with a clean, soft cloth.

Do not wipe the refrigerator with a soiled dish cloth or wet towel. These may leave a residue that can erode the paint. Do not use scouring pads, powdered cleaners, bleach or cleaners containing bleach because these products can scratch and weaken the paint finish.

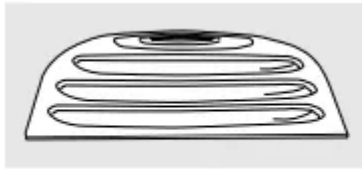

Dispenser drip area.

Cleaning the Inside

To help prevent odors, leave an open box of baking soda in the fresh food and freezer compartments.

Unplug the refrigerator before cleaning. If this is not practical, wring excess moisture out of sponge or cloth when cleaning around switches, lights or controls.

Use warm water and baking soda solution— about a tablespoon (15 ml) of baking soda to a quart (1 liter) of water. This both cleans and neutralizes odors. Rinse and wipe dry.

Use of any cleaning solution other than that which is recommended, especially those that contain petroleum distillates, can crack or damage the interior of the refrigerator.

Avoid cleaning cold glass shelves with hot water because the extreme temperature difference may cause them to break. Handle glass shelves carefully. Bumping tempered glass can cause it to shatter.

Do not wash any plastic refrigerator parts in the dishwasher.

The chill/thaw tray is dishwasher safe

Behind the Refrigerator

Be careful when moving the refrigerator away from the wall. All types of floor coverings can be damaged, particularly cushioned coverings and those with embossed surfaces.

Pull the refrigerator straight out and return it to position by pushing it straight in. Moving the refrigerator in a side direction may result in damage to the floor covering or refrigerator.

When pushing the refrigerator back, make sure you don't roll over the power cord or water supply line.

Preparing for Vacation

For long vacations or absences, remove food and unplug the refrigerator. Clean the interior with a baking soda solution of one tablespoon (15 ml) of baking soda to one quart (1 liter) of water. Leave the doors open.

If the temperature can drop below freezing, have a qualified service technician drain the water supply system to prevent serious property damage due to flooding.

Preparing to Move

Secure all loose items such as shelves and drawers by taping them securely in place to prevent damage.

When using a hand truck to move the refrigerator, do not rest the front or back of the refrigerator against the hand truck. This could damage the refrigerator. Handle only from the sides of the refrigerator.

Be sure the refrigerator stays in an upright position during moving.

Replacing the Light Bulbs

WARNING Before replacing a burned-out light bulb, the refrigerator should be unplugged in order to avoid contact with a live wire filament. (A burned-out light bulb may break when being replaced.) Turning the control to the OFF position does not remove power to the light circuit.

Refrigerator Compartment-Upper Light

1. Unplug the refrigerator.
2. The bulbs are located at the top of the compartment, inside the light shield. On some models, a screw at the front of the light shield will have to be removed. On other models, the screw is located in the pocket located at the back of the shield.
3. To remove the light shield, on some models, press in on the tabs on the sides of the shield and slide forward and out. On other models, just slide the shield forward and out. Your light shield will look like one of the following:
4. After replacing the bulb with an appliance bulb of the same or lower wattage, replace the light shield and screw. When replacing the light shield, make sure that the tabs at the back of the shield fit into the slots at the back of the light shield housing.
5. Plug the refrigerator back in.

Your light shield will look like one of the following:

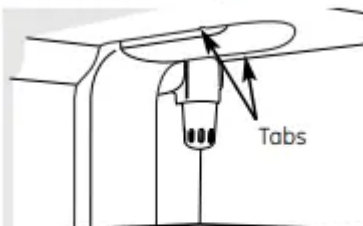

OR

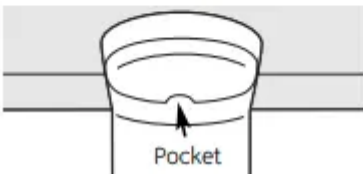

Refrigerator Compartment-Lower Light

This light is located above the top drawer.

1. Unplug the refrigerator.
2. Remove the convertible meat drawer control knob by pulling straight out.
3. Lift the light shield up and pull it out.
4. After replacing the bulb with an appliance bulb of the same or lower wattage, replace the shield and the knob.
5. Plug the refrigerator back in.

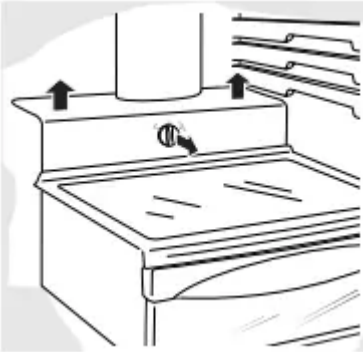

Freezer Compartment

1. Unplug the refrigerator.
2. Remove the shelf just above the light shield. (The shelf will be easier to remove if it is emptied first.) Remove the screw at the top of the light shield.
3. To remove the light shield, press in on the sides, and lift up and out.
4. Replace the bulb with an appliance bulb of the same or lower wattage, and reinstall the light shield. When reinstalling the light shield, make sure the top tabs snap securely into place. Replace the screw.
5. Reinstall the shelf and plug the refrigerator back in.

Dispenser (on some models)

1. Unplug the refrigerator.
2. The bulb is located on the dispenser under the control panel. Remove the light bulb by turning it counterclockwise.
3. Replace the bulb with a bulb of the same size and wattage.
4. Plug the refrigerator back in.

Refrigerator Compartment (LCD models only)

There is an LED lighting display in the top of the refrigerator compartment in LCD models. If this assembly needs to be replaced, call GE Service at 1.800.432.2737 in the United States or 1.800.561.3344 in Canada.

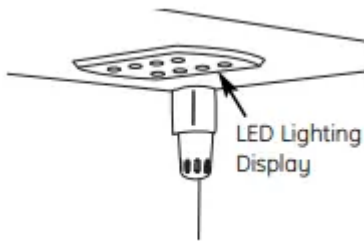

TROUBLESHOOTING TIPS

Normal Operating Conditions.

Newer refrigerators sound different from older refrigerators

Modern refrigerators have more features and use newer technology

Do you hear what I hear? These conditions are normal.

- The new high efficiency compressor may run faster and longer than your old refrigerator and you may hear a high-pitched hum or pulsating sound while it is operating.
- You may hear a whooshing sound when the doors close. This is due to pressure equalizing within the refrigerator.

CLICKS, POPS, CRACKS and SNAPS

- You may hear cracking or popping sounds when the refrigerator is first plugged in. This happens as the refrigerator cools to the correct temperature.
- Expansion and contraction of cooling coils during and after defrost can cause a cracking or popping sound.
- On models with an icemaker, after an ice making cycle, you may hear the ice cubes dropping into the ice bucket.
- On models with a dispenser, during water dispense, weder you may hear the water lines move at initial dispense and after dispenser button is released.
- You may hear the fans spinning at high speeds. This happens when the refrigerator is first plugged in, when the doors are opened frequently or when a large amount of food is added to the refrigerator or freezer compartments. The fans are helping to maintain the correct temperatures.
- The fans change speeds in order to provide optimal cooling and energy savings.

WATER SOUNDS

- The flow of refrigerant through the cooling coils may make a gurgling noise like boiling water.
- Water dropping on the defrost heater can cause a sizzling, popping or buzzing sound during the defrost cycle.

- A water dripping noise may occur during the defrost cycle as ice melts from the evaporator and flows into the drain pan.
- Closing the door may cause a gurgling sound due to pressure equalization.



Before you call for service



Problem	Possible Causes	What To Do
Refrigerator does not operate	Refrigerator in defrost cycle.	• Wait about 30 minutes for defrost cycle to complete.
	Either or both controls set to OFF.	• Set the controls to a temperature setting.
	Refrigerator is unplugged.	• Push the plug completely into the outlet.
	The fuse is blown/circuit breaker is tripped.	• Replace fuse or reset the breaker.
	The refrigerator is in showroom mode.	• Unplug the refrigerator and plug it back in.
Vibration or rattling (slight vibration is normal)	Rollers need adjusting.	• See <i>Rollers</i> .
Motor operates for long periods or cycles on and off frequently. (Modern refrigerators with more storage space and a larger freezer require more operating time. They start and stop often to maintain even temperatures.)	Normal when refrigerator is first plugged in.	• Wait 24 hours for the refrigerator to complete its defrost cycle.
	Often occurs when large amounts of food are placed in refrigerator.	• This is normal.
	Door left open.	• Check to see if package is holding door open.
	Hot weather or frequent door openings.	• This is normal.
	Temperature controls set at the coldest setting.	• See <i>About the controls</i> .
Refrigerator or freezer compartment too warm	Temperature control not set cold enough.	• See <i>About the controls</i> .
	Warm weather or frequent door openings.	• Set the temperature control one step colder. See <i>About the controls</i> .
	Door left open.	• Check to see if package is holding door open.
	Door left open.	• Check to see if package is holding door open.



<p><i>Frost or ice crystals on frozen food (frost within package is normal)</i></p>	<p>Too frequent or too long door openings.</p>	
<p><i>Divider between refrigerator and freezer compartments feels warm</i></p>	<p>Automatic energy saver system circulates warm liquid around front edge of freezer compartment.</p>	<ul style="list-style-type: none"> • This helps prevent condensation on the outside of the refrigerator.
<p><i>Automatic icemaker does not work</i></p>	<p>Icemaker power switch is in the off position.</p>	<ul style="list-style-type: none"> • Set the power switch to the on position.
	<p>Water supply turned off or not connected.</p>	<ul style="list-style-type: none"> • See <i>Installing the water line</i>.
	<p>Freezer compartment too warm.</p>	<ul style="list-style-type: none"> • Wait 24 hours for the refrigerator to complete defrost cycle.
	<p>Piled up cubes in the storage bin cause the icemaker to shut off.</p>	<ul style="list-style-type: none"> • Level cubes by hand.
	<p>Ice cubes stuck in icemaker. (Green power light on icemaker blinking).</p>	<ul style="list-style-type: none"> • Turn off the icemaker, remove cubes and turn icemaker back on.



<i>Frequent “buzzing” sound</i>	Icemaker power switch is in the <i>I (on)</i> position, but the water supply to the refrigerator has not been connected.
<i>Ice cubes have odor/ taste</i>	Ice storage bin needs cleaning.
	Food transmitting odor/taste to ice cubes.
	Interior of refrigerator needs cleaning.
<i>Small or hollow cubes</i>	Water filter clogged.
<i>Slow ice cube freezing</i>	Door left open.
	Temperature control not set cold enough.
<i>Cube dispenser does not work</i>	Icemaker turned off or water supply turned off.
	An item is blocking or has fallen into the ice chute inside the top door bin or the freezer.
	Ice cubes are frozen to icemaker feeler arm.
	Irregular ice clumps in storage container.
	Dispenser is <i>LOCKED</i>.
<i>Water has poor taste/ odor</i>	Water dispenser has not been used for a long time.



<i>Water in first glass is warm</i>	Normal when refrigerator is first installed.
	Water dispenser has not been used for a long time.
	Water system has been drained.
<i>Water dispenser does not work</i>	Water supply line turned off or not connected.
	Water filter clogged.
	Air may be trapped in the water system.
	Dispenser is <i>LOCKED</i>.
<i>Water spurting from dispenser</i>	Newly-installed filter cartridge.
<i>Water is not dispensed but icemaker is working</i>	Water in reservoir is frozen.
	Refrigerator control setting is too cold.
<i>No water or ice cube production</i>	Supply line or shutoff valve is clogged.
	Water filter clogged.
	Dispenser is <i>LOCKED</i>.
<i>CUBED ice was selected but CRUSHED ice was dispensed</i>	Last setting was <i>CRUSHED</i>.



<i>Orange glow in the freezer</i>	Defrost heater is on.
<i>Refrigerator has odor</i>	Foods transmitting odor to refrigerator.
	Interior needs cleaning.
<i>Door not closing properly</i>	Door gasket on hinge side sticking or folding over.
	A door bin is hitting a shelf inside the refrigerator.
<i>Moisture forms on</i>	Not unusual during periods of high humidity.
<i>Moisture collects inside (in humid weather, air carries moisture into refrigerator when doors are opened)</i>	Too frequent or too long door openings.
	Due to the higher humidity in the refrigerator, you may on occasion experience fog or small amounts of moisture in the refrigerator compartment.
<i>Interior light does not work</i>	No power at outlet.
	Light bulb burned out. .
<i>Water on kitchen floor or on bottom of freezer</i>	Cubes jammed in chute.
<i>Hot air from bottom of refrigerator</i>	Normal air flow cooling motor. In the refrigeration process, it is normal that floor coverings are sensitive and will discolor at these normal and safe temperatures.

<i>Refrigerator never shuts off but the temperatures are OK</i>	Adaptive defrost keeps compressor running during door openings.
<i>Refrigerator beeping</i>	Door open.
<i>Food isn't thawing/ chilling</i>	Packaging.
	Wrong weight selected.
	Item with high fat content.
	Not using Chill/Thaw tray.
<i>Actual temperature not equal to Set temperature</i>	Unit just plugged in.
	Door open for too long.
	Warm food added to refrigerator.
	Defrost cycle is in process.
<i>SelectTemp or Beverage Center feature is not working</i>	Refrigerator compartment temperature control is set at warmest setting.
	Beverage Center feature turns off after six months of continuous operation.
<i>While QuickFreeze™ is enabled, the actual freezer temperature may drop as low as -3°F (-19°C)</i>	<ul style="list-style-type: none"> • This is normal.

Warning



This content is compiled from multiple sources and is provided for reference purposes only. It may not be complete or fully applicable to all situations. If you are unable to resolve your issue, please contact the product manufacturer or an authorized service provider for official support.

Document generated by [ManualsFile](#)

