

FEATURE GUIDE

⚠ WARNING

Food Poisoning Hazard

Do not let food sit for more than one hour before or after cooking.

Doing so can result in food poisoning or sickness.



Keypad	Feature	Instructions
CLOCK/TOOLS	Clock	The Clock can use a 12- or 24-hour cycle. See the "Electronic Oven Controls" section. <ol style="list-style-type: none"> 1. Press CLOCK/TOOLS until "CLOCK" is displayed. 2. Use the number keypads to set the time of day. 3. Press START to change the time. 4. Press "3" for AM or "6" for PM.
CLOCK/TOOLS	Settings	Enables you to personalize the audible tones and oven operation to suit your needs. See the "Electronic Oven Controls" section.
OVEN LIGHT	Oven cavity light	The oven light is controlled by a keypad on the oven control panel. While the oven door is closed, press OVEN LIGHT to turn the light on and off. When the oven door is opened, the oven light will automatically come on.
TIMER SET/OFF	Oven timer	The Timer can be set in hours or minutes up to 9 hours and 59 minutes. <ol style="list-style-type: none"> 1. Press TIMER SET/OFF. 2. Press the number keypads to set the length of time in hr-min-min. Leading zeros do not have to be entered. For example, for 2 minutes, enter "2." 3. Press TIMER SET/OFF to begin the countdown. If enabled, end-of-cycle tones will sound at end of countdown. 4. Press TIMER SET/OFF again to cancel the Timer and return to the time of day. Do not press the Cancel keypad because the oven will turn off. 5. If the Timer is running but not in the display, press TIMER SET/OFF to display the countdown for 5 seconds.
START	Cooking start	The Start keypad begins any oven function. If Start is not pressed within 2 minutes after pressing a keypad, the function is canceled and the time of day is displayed.
CANCEL UPPER CANCEL LOWER (on some models)	Range function	The Cancel keypad stops any function for the appropriate oven or drawer, except the Clock and Timer.
BAKE	Baking and roasting	<ol style="list-style-type: none"> 1. Press BAKE. 2. Set the desired temperature between 170°F and 500°F (75°C and 260°C) using the number keypads. The default temperature is 350°F (180°C). 3. Press START. 4. To change the temperature, repeat steps 2 and 3. 5. Press CANCEL UPPER when finished.



Keypad	Feature	Instructions
STEAM BAKE	Steam bake	<ol style="list-style-type: none"> 1. Insert the steam rack with water reservoir in the oven. 2. Pour 1½ cups (350 mL) of warm water into the water reservoir. NOTE: Do not fill past the MAX mark. 3. Press STEAM BAKE. 4. Press the number keypad to select the desired food option. 5. Press the number keypads to set the temperature. 6. Press START. 7. (Optional) Press COOK TIME. Press the number keypads to set the cook time. 8. Press START. 9. Insert food when preheating finishes. 10. Press CANCEL UPPER when finished. NOTE: Let oven cool before removing and emptying water reservoir.
BROIL	Broiling	<ol style="list-style-type: none"> 1. Press BROIL. 2. Press the number keypads to set the desired temperature. 3. Press START and allow the oven to preheat for 2 minutes. 4. To change the temperature, repeat steps 2 and 3. 5. Position the cookware in the oven, and then close the door. 6. Press CANCEL UPPER when finished.
PROOF	Proofing bread	<ol style="list-style-type: none"> 1. Place prepared dough in oven. Press PROOF. 2. Press START. Let the dough rise until nearly doubled in size. Proofing time may vary depending on dough type and quantity. 3. Press CANCEL UPPER when finished proofing. Refer to the "Proofing Bread" section for more information.
KEEP WARM	Hold warm	<p>Food must be at serving temperature before placing it in the warmed oven.</p> <ol style="list-style-type: none"> 1. Press KEEP WARM. 2. Set the desired temperature between 145°F and 190°F (63°C and 88°C) using the number keypads. The default temperature is 170°F (75°C). 3. Press START. 4. Press CANCEL UPPER when finished.
EASY CONVECT BAKE	Convection cooking	<ol style="list-style-type: none"> 1. Press EASY CONVECT BAKE. 2. Press "1" to have the oven automatically convert the temperature and time for convection baking. Press "2" to manually convert the temperature and time. 3. Press the number keypads to set a temperature other than 325°F (177°C) in 5° increments between 170°F and 500°F (77°C and 260°C). 4. Press START. 5. (Optional) Press the number keypads to set a cook time. 6. Press START. 7. To change the temperature, repeat steps 2 and 3. 8. Press CANCEL UPPER when finished.
EASY CONVECT BROIL	Convection cooking	<ol style="list-style-type: none"> 1. Press EASY CONVECT BROIL. 2. Press "1" to have the oven automatically convert the temperature and time for convection baking. Press "2" to manually convert the temperature and time. 3. Press the number keypads to set a temperature other than 325°F (177°C) in 5° increments between 170°F and 500°F (77°C and 260°C). 4. Press START. 5. (Optional) Press the number keypads to set a cook time. 6. Press START. 7. To change the temperature, repeat steps 2 and 3. 8. Press CANCEL UPPER when finished.



Keypad	Feature	Instructions
EASY CONVECT ROAST	Convection cooking	<ol style="list-style-type: none"> 1. Press EASY CONVECT ROAST. 2. Press "1" to have the oven automatically convert the temperature and time for convection baking. Press "2" to manually convert the temperature and time. 3. Press the number keypads to set a temperature other than 325°F (177°C) in 5° increments between 170°F and 500°F (77°C and 260°C). 4. Press START. 5. (Optional) Press the number keypads to set a cook time. 6. Press START. 7. To change the temperature, repeat steps 2 and 3. 8. Press CANCEL UPPER when finished.
COOK TIME	Timed cooking	<p>Timed cooking allows the oven to be set to turn on at a certain time of day, cook for a set length of time, and/or shut off automatically.</p> <p>To set a Timed Cook or a Delayed Timed Cook, see the "Cook Time" section.</p>
DELAY START	Delayed start	<p>The Delay Start keypad is used to enter the starting time for an oven function with a delayed start. Delay Start should not be used for foods such as breads and cakes because they may not bake properly.</p> <p>To set a Timed Cook or a Delayed Timed Cook, see the "Cook Time" section.</p>
BAKING DRAWER BAKE (on some models)	Baking drawer	<ol style="list-style-type: none"> 1. Press BAKING DRAWER BAKE. 2. Set the desired temperature between 170°F and 451°F (75°C and 233°C) using the number keypads. The default temperature is 350°F (180°C). 3. Press START. 4. To change the temperature, repeat steps 2 and 3. 5. Press CANCEL LOWER when finished.
BAKING DRAWER SLOW COOK (on some models)	Slow cook drawer	<ol style="list-style-type: none"> 1. Press BAKING DRAWER SLOW COOK. 2. Set the desired temperature between 145°F and 190°F (63°C and 88°C) using the number keypads. The default temperature is 170°F (75°C). 3. Place the food(s) in the baking drawer. 4. Press START. 5. (Optional) Set the desired cook time using the number keypads. 6. Press START to begin heating the baking drawer. 7. Press CANCEL LOWER when finished.
BAKING DRAWER KEEP WARM (on some models)	Warming drawer	<p>Food must be at serving temperature before placing it in the warmed oven.</p> <ol style="list-style-type: none"> 1. Press BAKING DRAWER KEEP WARM. 2. Set the desired temperature between 145°F and 190°F (63°C and 88°C) using the number keypads. The default temperature is 170°F (75°C). 3. Press START. 4. Press CANCEL LOWER when finished.
WARM ZONE ON/OFF/CONFIRM	Warming zone	<p>Press WARM ZONE ON/OFF to select the warming element on the cooktop, and then press WARM ZONE CONFIRM.</p> <p>Press WARM ZONE ON/OFF again to turn off the warming element.</p>
AQUALIFT SELF CLEAN	Clean cycle	See the "Clean Cycle" section.
START (Hold 3 Sec)	Oven control lockout	<ol style="list-style-type: none"> 1. Check that the oven is OFF. 2. Press and hold START (Hold 3 Sec) for 3 seconds. 3. A tone will sound, and "Control Locked" will scroll, and then "Locked" will be displayed. 4. Repeat to unlock. No keypads will function with the controls locked. The cooktop functions are not affected by the oven control lockout.
CLOCK/TOOLS	Energy save	<ol style="list-style-type: none"> 1. Press CLOCK/ TOOLS until "ENERGY SAVE" is displayed. 2. The current setting will be displayed. 3. Press the "1" keypad to adjust the setting. 4. Press CANCEL to exit and display the time of day. <p>If Energy Save is on, the range will go into sleep mode after 5 minutes of inactivity. Any keypad press will activate the display. If Energy Save is off, the display will be on at all times.</p>

Electronic Oven Controls

Control Display

The display will flash when powered up or after a power loss. Press CANCEL UPPER to clear. When the oven is not in use, the time of day is displayed. If the range is in Energy Save mode, the display will be blank when not in use.

Tones

Tones are audible signals, indicating the following:

One Tone

- Valid keypad press
- Oven is preheated (long tone).
- Function has been entered.
- Reminder, repeating each minute after the end-of-cycle tones

Three Tones

- Invalid keypad press

Four Tones

- End-of-cycle Use the Clock/Tools keypad to change the tone settings.

Energy Save

The Energy Save mode puts the range into Sleep mode and reduces energy consumption.

To Activate the Energy Save Mode:

1. Press CLOCK/TOOLS until “ENERGY SAVE” is displayed.
2. The current setting will be displayed.
3. Press the “1” keypad to adjust the setting.
4. Press CANCEL to exit and display the time of day.
5. The setting will be activated after 5 minutes.

To Deactivate the Energy Save Mode:

1. Press CLOCK/TOOLS until “ENERGY SAVE” is displayed.
2. The current setting will be displayed.
3. Press the “1” keypad to adjust the setting.
4. Press CANCEL to exit and display the time of day.
5. The clock will reappear in the display and the range can be operated as usual.

Settings

Many features of the oven control can be adjusted to meet your personal needs. These changes are made using the Clock/Tools keypad.

Use the Clock/Tools keypad to scroll through the features that can be changed. Each press of the Clock/Tools keypad will advance the display to the next setting. After selecting the feature to be changed, the control will prompt you for the required input. Then press START or CANCEL UPPER to exit and display the time of day. Details of all of the feature changes are explained in the following sections. Press CANCEL UPPER to exit Settings.

Clock

The Clock can use a 12- or 24-hour cycle.

1. Press CLOCK/TOOLS until "CLOCK" is displayed.
2. Use the number keypads to set the time of day.
3. Press START to change the time.
4. Press "3" for AM or "6" for PM.

Fahrenheit and Celsius

The temperature is preset to Fahrenheit but can be changed to Celsius.

1. Press CLOCK/TOOLS until "TEMP UNIT" is displayed.
2. The current setting will be displayed.
3. Press the "1" keypad to adjust the setting.
4. Press START or CANCEL UPPER to exit and display the time of day.

Audible Tones Disable

Turns off all tones, including the end-of-cycle tone and keypress tones. Reminder tones are still active when all tones are disabled.

1. Press CLOCK/TOOLS until "SOUND" is displayed.
2. The current setting will be displayed.
3. Press the "1" keypad to adjust the setting.
4. Press START or CANCEL UPPER to exit and display the time of day.

Sound Volume

Sets the volume of the tone to either high or low.

1. Press CLOCK/TOOLS until "SOUND VOLUME" is displayed.
2. The current setting will be displayed.
3. Press the "1" keypad to adjust the setting.
4. Press START or CANCEL UPPER to exit and display the time of day.

End-of-Cycle Tone

Activates or turns off the tones that sound at the end of a cycle.

1. Press CLOCK/TOOLS until "END TONE" is displayed.
2. The current setting will be displayed.
3. Press the "1" keypad to adjust the setting.
4. Press START or CANCEL UPPER to exit and display the time of day.

Keypress Tones

Activates or turns off the tones when a keypad is pressed.

1. Press CLOCK/TOOLS until "KEYPRESS TONE" is displayed.
2. The current setting will be displayed.
3. Press the "1" keypad to adjust the setting.
4. Press START or CANCEL UPPER to exit and display the time of day.

Reminder Tones Disable

Turns off the short repeating tone that sounds every 1 minute after the end-of-cycle tones.

1. Press CLOCK/TOOLS until "REMINDER TONE" is displayed.
2. The current setting will be displayed.
3. Press the "1" keypad to adjust the setting.
4. Press START or CANCEL UPPER to exit and display the time of day.

12/24 Hour Clock

1. Press CLOCK/TOOLS until "12/24 HOUR" is displayed.
2. The current setting will be displayed.
3. Press the "1" keypad to adjust the setting.
4. Press START or CANCEL UPPER to exit and display the time of day

Demo Mode

IMPORTANT: This feature is intended for use on the sales floor with 120 V power connection and permits the control features to be demonstrated without the oven turning on. If this feature is activated, the oven will not work.

1. Press CLOCK/TOOLS until "DEMO MODE" is displayed.
2. The current setting will be displayed.
3. Press the "1" keypad to adjust the setting.
4. Press START or CANCEL UPPER to exit and display the time of day.

Sabbath Mode

The Sabbath mode sets the oven to remain ON in a bake setting until turned off. When the Sabbath mode is set, only the Bake cycle will operate. All other cooking and cleaning cycles are disabled. No tones will sound and the displays will not indicate temperature changes. When the oven door is opened or closed, the oven light will not turn on or off and the heating elements will not turn on or off immediately.

To Enable Sabbath Mode Capability (One Time Only):

1. Press CLOCK/TOOLS until “SABBATH” is displayed.
2. The current setting will be displayed.
3. Press the “1” keypad to adjust the setting.
4. Press START or CANCEL UPPER to exit and display the time of day.

12-Hour Shutoff

The oven control is set to automatically shut off the oven 12 hours after the oven initiates a cook or clean function. This will not interfere with any timed or delay cook functions.

1. Press CLOCK/TOOLS until “12Hr AUTO_OFF” is displayed.
2. The current setting will be displayed.
3. Press the “1” keypad to adjust the setting.
4. Press START or CANCEL UPPER to exit and display the time of day

Languages - Scrolling Display Text

Language options are English, Spanish, and French.

1. Press CLOCK/TOOLS until “LANGUAGE” is displayed.
2. The current setting will be displayed.
3. Press the “1” or “2” keypad to select the desired language.
4. Press START or CANCEL UPPER to exit and display the time of day.

Oven Temperature Offset Control

IMPORTANT: Do not use a thermometer to measure oven temperature. Elements will cycle on and off as needed to provide consistent temperature but may run slightly hot or cool at any point in time due to this cycling. Most thermometers are slow to react to temperature change and will not provide an accurate reading due to this cycling. The oven provides accurate temperatures; however, it may cook faster or slower than your previous oven, so the temperature can be adjusted to personalize it for your cooking needs. It can be changed to Fahrenheit or Celsius.

To Adjust Oven Temperature:

1. Press CLOCK/TOOLS until “TEMP CALIB” is displayed.
2. On some models, press “1” to adjust the drawer temperature calibration. Press START, wait 10 seconds for the display to change, and then continue with Step 3. OR Press START to adjust the oven temperature calibration. Wait 10 seconds for the display to change, and then continue with Step 3.
3. Press the “3” keypad to increase the temperature in 5°F (3°C) increments or press the “6” keypad to decrease the temperature in 5°F (3°C) increments. The offset range is from -30°F to +30°F (-18°C to +18°C).



4. Press START or CANCEL UPPER to exit and display the time of day

COOKTOP

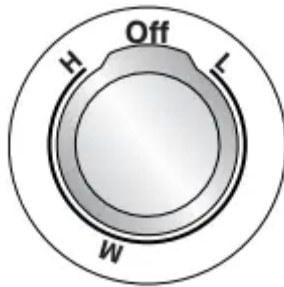

NOTE: Settings are marked on the control knob. The control knobs can be set to anywhere between H (High) and L (Low). Push in and turn to setting.

REMEMBER: When range is in use, the entire cooktop area may become hot.

Ceramic Glass

The surface cooking area may glow red when an element is ON. Some parts of the surface cooking area may not glow red when an element is ON. The glow will also randomly cycle off and back on again, even while on High, to keep the cooktop from extreme temperatures. This is normal operation.

It is normal for the surface of light colored ceramic glass to appear to change color when surface cooking areas are hot. As the glass cools, it will return to its original color.

Clean the cooktop after each use to help avoid scratches, pitting, abrasions and to condition the glass surface. Ceramic glass cooktop cleaner and a cooktop scraper are also recommended for stubborn soils. Do not use abrasive cleaners, cleaning pads, or harsh chemicals for cleaning. The Cooktop Care Kit contains all of the items needed to clean and condition your ceramic glass cooktop. Refer to the "Range Care" section for additional information

IMPORTANT: To avoid permanent damage to the cooktop surface and to make soils easier to remove, clean the cooktop after each use to remove all soils.

- Avoid storing jars or cans above the cooktop. Dropping a heavy or hard object onto the cooktop could crack the cooktop.
- To avoid damage to the cooktop, do not leave a hot lid on the cooktop. As the cooktop cools, air can become trapped between the lid and the cooktop, and the ceramic glass could break when the lid is removed.
- For foods containing sugar in any form, clean up all spills and soils as soon as possible. Allow the cooktop to cool down slightly. Then, while wearing oven mitts, remove the spills using a scraper while the surface is still warm. If sugary spills are allowed to cool down, they can adhere to the cooktop and can cause pitting and permanent marks.
- To avoid scratches, do not slide cookware or bakeware across the cooktop. Aluminum or copper bottoms and rough finishes on cookware or bakeware could leave scratches or marks on the cooktop.
- Do not cook popcorn in prepackaged aluminum containers on the cooktop. They could leave aluminum marks that cannot be removed completely.
- To avoid damage to the cooktop, do not allow objects that could melt, such as plastic or aluminum foil, to touch any part of the entire cooktop.
- To avoid damage to the cooktop, do not use the cooktop as a cutting board.
- Use cookware about the same size as the surface cooking area. Cookware should not extend more than 1/2" (1.3 cm) outside the area.

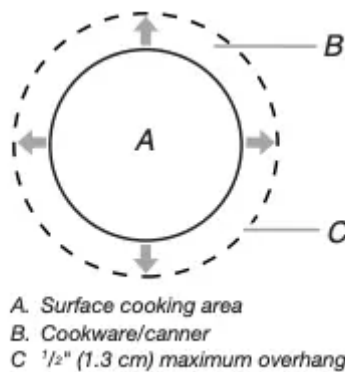

- Use flat-bottomed cookware for best heat conduction and energy efficiency. Cookware with rounded, warped, ribbed, or dented bottoms could cause uneven heating and poor cooking results.
- Determine flatness by placing the straight edge of a ruler across the bottom of the cookware. While you rotate the ruler, no space or light should be visible between it and the cookware.
- Cookware designed with slightly indented bottoms or small expansion channels can be used.

- Make sure the bottoms of pots and pans are clean and dry before using them. Residue and water can leave deposits when heated.
- To avoid damage to the cooktop, do not cook foods directly on the cooktop.

Cooktop On Indicator Light

The Cooktop On indicator light is located on the console panel. When any control knob on the console panel is turned on, the Cooktop On indicator light will glow.

Hot Surface Indicator Light

On ceramic glass models, the Hot Surface indicator light is located on the console panel.

The Hot Surface indicator light will glow as long as any surface cooking area is too hot to touch, even after the surface cooking area is turned off.

Triple Zone Cooking Element

The Triple Zone cooking element offers flexibility depending on the size of the cookware. Single size can be used in the same way as a regular element. The dual and triple sizes combine the single, dual, and outer element and is recommended for larger cookware, larger quantities of food and home canning.

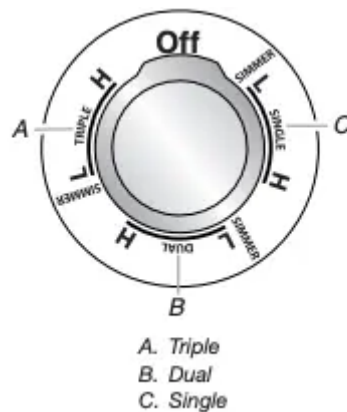

NOTE: Settings are marked on the control knob.

Rapid Boil Element (Right Front Element)

The Rapid Boil cooking element offers additional cooking flexibility. The Rapid Boil cooking element can be used to boil liquids faster. The lowest melt setting can be used to prepare sauces, to brown or sauté foods, and to keep foods at a low temperature. Use cookware appropriate in size for the Rapid Boil cooking element.

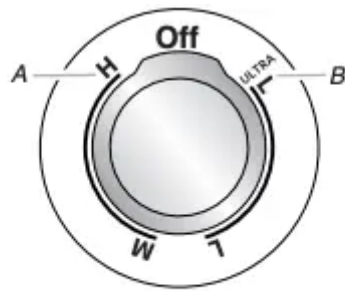

A. Rapid boil option
B. Lower heat option

NOTE: Settings are marked on the control knob.

Melt Element (Left Rear Element)

The Melt cooking element offers flexibility due to a wide range of settings between High and Melt. The High heat option can be used to boil small amounts of liquid quickly. To reduce the power setting, turn the knob clockwise. The Melt setting is designed for delicate foods that require low heat, such as when melting chocolate or holding sauces. Use cookware appropriate in size for the Melt cooking element.

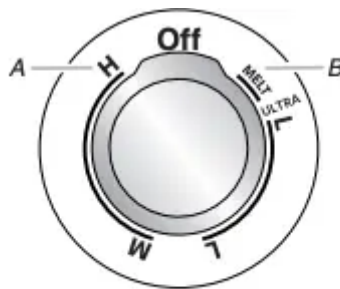

A. High heat option
B. Melt option

NOTE: Settings are marked on the control knob.

Warm Zone Element

⚠ WARNING

Food Poisoning Hazard

Do not let food sit in oven more than one hour before or after cooking.

Doing so can result in food poisoning or sickness.

Use the Warm Zone element to keep cooked foods warm. One hour is the recommended maximum time to maintain food quality. Do not use it to heat cold foods. The Warm Zone element can be used alone or when any of the other surface cooking areas are being used. The Warm Zone element area will not glow red when cycling on. However, the Cooktop On indicator light will be displayed when the Warm Zone is in use.

- Use only cookware recommended for oven and cooktop use.



- Cover all foods with a lid or aluminum foil. When warming baked goods, allow a small opening in the cover for moisture to escape.
- To avoid damage to the cooktop, do not use plastic wrap to cover food because the plastic wrap may melt.
- Use pot holders or oven mitts to remove food.



To Use:

1. To turn on, press WARM ZONE ON/OFF and then WARM ZONE CONFIRM.
2. To turn off, press WARM ZONE ON/OFF.

Cookware

IMPORTANT: Do not leave empty cookware on a hot surface cooking area, element or surface burner.

Ideal cookware should have a flat bottom, straight sides, and a well-fitting lid, and the material should be of medium-to-heavy thickness.

Rough finishes may scratch the cooktop. Aluminum and copper may be used as a core or base in cookware. However, when used as a base, they can leave permanent marks on the surfaces.

Cookware material is a factor in how quickly and evenly heat is transferred which affects cooking results. A nonstick finish has the same characteristics as its base material. For example, aluminum cookware with a nonstick finish will take on the properties of aluminum.

Cookware with nonstick surfaces should not be used under the broiler.

Check for flatness by placing the straight edge of a ruler across the bottom of the cookware. While you rotate the ruler, no space or light should be visible between it and the cookware.

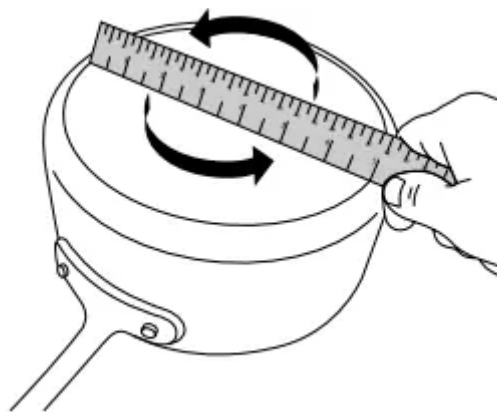

Use the following chart as a guide for cookware material characteristics.

Cookware	Characteristics
Aluminum	<ul style="list-style-type: none"> ■ Heats quickly and evenly. ■ Suitable for all types of cooking. ■ Medium or heavy thickness is best for most cooking tasks. ■ May leave aluminum residues, which may be diminished if cleaned immediately after cooking.
Cast iron	<ul style="list-style-type: none"> ■ Heats slowly and evenly. ■ Good for browning and frying. ■ Maintains heat for slow cooking. ■ Rough edges or burrs may scratch the cooktop.
Ceramic or ceramic glass	<ul style="list-style-type: none"> ■ Follow manufacturer's instructions. ■ Heats slowly, but unevenly. ■ Ideal results on low-to-medium heat settings. ■ May scratch the cooktop.
Copper	<ul style="list-style-type: none"> ■ Heats very quickly and evenly. ■ May leave copper residues, which may be diminished if cleaned immediately after cooking. ■ Can leave a permanent stain or bond to the cooktop if overheated.
Earthenware	<ul style="list-style-type: none"> ■ Follow manufacturer's instructions. ■ Use on low heat settings. ■ May scratch the cooktop.
Porcelain enamel-on-steel or cast iron	<ul style="list-style-type: none"> ■ See stainless steel or cast iron. ■ Porcelain enamel bakeware without the metal base may bond to the cooktop if overheated.
Stainless steel	<ul style="list-style-type: none"> ■ Heats quickly, but unevenly. ■ A core or base of aluminum or copper on stainless steel provides even heating.

Use flat-bottomed cookware for best cooking results and energy efficiency. The cookware should be about the same size as the cooking area outlined on the cooktop. Cookware should not extend more than 1/2" (1.3 cm) outside the area.

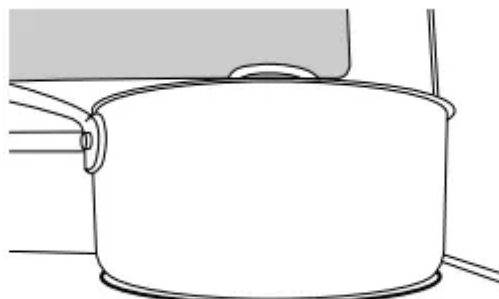

Home Canning

Canning can be performed on a glass smooth-top cooking surface or traditional coil element cooktop. When canning for long periods, alternate the use of surface cooking areas or elements between batches. This allows time for the most recently used areas to cool.

- Center the canner on the largest surface cooking area or element. On electric cooktops, canners should not extend more than 1 /2" (1.3 cm) beyond the surface cooking area or element.
- Do not place canner on 2 surface cooking areas or elements at the same time.
- On ceramic glass models, use only flat-bottomed canners to avoid damage to the cooktop and elements.
- For more information, contact your local agricultural extension office or refer to published home canning guides. Companies that manufacture home canning products can also offer assistance.

OVEN

Odors and smoke are normal when the oven is used the first few times or when it is heavily soiled.

IMPORTANT: The health of some birds is extremely sensitive to the fumes given off by the oven. Exposure to the fumes may result in death to certain birds. Always move birds to another closed and well-ventilated room.

Aluminum Foil

IMPORTANT: To avoid permanent damage to the oven bottom finish, do not line the oven bottom with any type of foil or liner. For best cooking results, do not cover entire oven rack with foil because air must be able to move freely.

Sabbath Mode

The Sabbath mode sets the oven to remain on in a bake setting until turned off. When the Sabbath mode is set, only the Bake cycle will operate. All other cooking and cleaning cycles are disabled. No tones will sound and the displays will not indicate temperature changes. When the oven door is opened or closed, the oven light will not turn on or off and the heating elements will not turn on or off immediately.

To Enable Sabbath Mode Capability (One Time Only):

1. Press CLOCK/TOOLS until "SABBATH" is displayed. "OFF. Press (1) for On" will scroll in the display.
2. Press the "1" keypad. "ON. Press (1) for Off" will scroll in the display. Sabbath mode can be activated for baking.

3. Press START or CANCEL UPPER to exit and display the time of day.

NOTE: To disable the Sabbath mode, repeat steps 1 through 3 to change the status from “SABBATH ON” to “SABBATH OFF.”

To Activate Sabbath Mode:

1. Press BAKE for the desired oven.
2. Press the number keypad to set a temperature other than 350°F (177°C).
3. Press START. For timed cooking in Sabbath mode, press COOK TIME and then the number keypads to set the desired cook time.
4. Press CLOCK/TOOLS. Three tones will sound. Then press “7.” “SAb” will appear in the display.

To Adjust Temperature (When Sabbath Mode Is Running):

1. Press the number keypad as instructed by the scrolling text to select the new temperature.

NOTE: The temperature adjustment will not appear on the display. The scrolling text will be shown on the display as it was before the keypad was pressed.

2. Press START.

To Deactivate Sabbath Mode:

Press CLOCK/TOOLS, and then press “7” to return to regular baking, or press CANCEL for the desired oven to turn off the range. **NOTE:** No tones will sound while deactivating Sabbath mode.

Baking and Roasting

Preheating

When beginning a Bake, Convection Bake, or Convection Roast cycle, the oven will begin preheating after Start is pressed. The oven will take approximately 12 to 15 minutes to reach 350°F (177°C) with all of the oven racks provided with your oven inside the oven cavity. Higher temperatures will take longer to preheat. The preheat cycle rapidly increases the oven temperature. The actual oven temperature will go above your set temperature to offset the heat lost when your oven door is opened to insert food. This ensures that when you place your food in the oven, the oven will begin at the proper temperature. Insert your food when the preheat tone sounds. Do not open the door during preheat before the tone sounds.

Oven Temperature

While in use, the oven elements will cycle on and off as needed to maintain a consistent temperature, but they may run slightly hot or cool at any point in time due to this cycling. Opening the oven door while in use will release the hot air and cool the oven which could impact the cooking time and performance. It is recommended to use the oven light to monitor cooking progress.

NOTE: On models with convection, the convection fan may run in the non-convection Bake mode to improve oven performance.

Temperature Management System

The Temperature Management System electronically regulates the oven heat levels during preheat and Bake to maintain a precise temperature range for optimal cooking results. The bake and broil elements or burners cycle on and off in intervals. On convection range models, the fan will run while preheating and may be cycled on and off for short intervals during Bake to provide the best results. This feature is automatically activated when the oven is in use.

Before baking and roasting, position racks according to the “Positioning Racks and Bakeware” section. When roasting, it is not necessary to wait for the oven preheat cycle to end before putting food in, unless it is recommended in the recipe.

Steam Bake

The Steam Bake function works in conjunction with the steam rack to provide additional moisture during baking. The steam rack contains a water reservoir which heats up and releases steam into the oven cavity during the Steam Bake cycle. There are preprogrammed food options to choose from: Breads, Desserts, and Fish as well as a Refresh/Reheat option.

For best performance, place the steam rack in the lowest available rack position in the cavity and pour 1/2 cups (350 mL) of water into the reservoir. Do not fill past the MAX level indicated on the reservoir.

After the Steam Bake cycle is complete, some water may remain in the reservoir. This is normal. Wait for the oven to cool and discard the water.



Broiling

When broiling, preheat the oven for 2 minutes before putting food in, unless recommended otherwise in the recipe. Position food on grid in a broiler pan, and then place it in the center of the oven rack.

IMPORTANT: Close the door to ensure proper broiling temperature.

Changing the temperature when broiling allows more precise control when cooking. The lower the broil setting is, the slower the cooking. Thicker cuts and unevenly shaped pieces of meat, fish, and

poultry may cook better at lower broil settings. Use rack 6 or 7 for broiling. Refer to the “Positioning Racks and Bakeware” section for more information.

On lower settings, the broil element will cycle on and off to maintain the proper temperature.

■ For best results, use a broiler pan and grid. It is designed to drain juices and help avoid spatter and smoke. If you would like to purchase a broiler pan, one may be ordered. See the “Accessories” section.

Convection Cooking

In a convection oven, the fan-circulated hot air continually distributes heat more evenly than the natural movement of air in a standard thermal oven. This movement of hot air helps maintain a consistent temperature throughout the oven, cooking foods more evenly, crisping surfaces while sealing in moisture and yielding crustier breads.

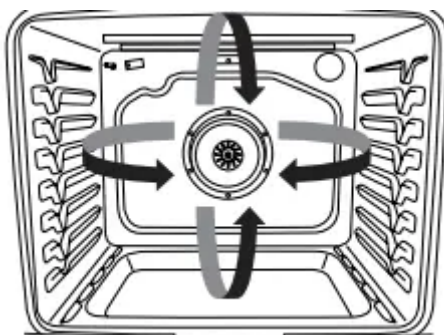

During convection baking or roasting, the bake, broil, and convection elements cycle on and off in intervals while the fan circulates the hot air. During convection broiling, the broil and convection elements cycle on and off. If the oven door is opened during convection cooking, the fan will turn off immediately. It will come back on when the oven door is closed.

With convection cooking, most foods can be cooked at a lower temperature and/or a shorter cooking time than in a standard thermal oven. Depending upon the selected cooking mode, EasyConvect™ conversion can automatically reduce the standard recipe temperature and/or time you input for convection cooking. If you choose not to use the EasyConvect™ conversion, use the following table as a guide.

Convection Mode	Time/Temperature Guidelines
Convection Bake	25°F (15°C) lower temperature, possible shortened cooking time
Convection Roast	Cooking time shortened by up to 30%
Convection Broil	Shortened cooking time

Convect Options

Convect Bake - multiple-rack baking or cookies, biscuits, breads, casseroles, tarts, tortes, cakes

Convect Roast - whole chicken or turkey, vegetables, pork roasts, beef roasts

Convect Broil - thicker cuts or unevenly shaped pieces of meat, fish, or poultry

Proofing Bread

Proofing bread prepares the dough for baking by activating the yeast. Follow the recipe directions as a guide. Proof should be used for fresh dough, thawed dough, and for the first and second rise.

To Proof:

Before first proofing, place the dough in a lightly greased bowl and cover loosely with wax paper, coated with shortening. Place on rack guide 2 and close the oven door.

NOTE: If the temperature of the oven is greater than 120°F (49°C), “Oven Cooling” will be displayed until the temperature is less than 120°F (49°C).

1. Press PROOF.
2. Press START. Let the dough rise until nearly doubled in size. Proofing time may vary depending on dough type and quantity.
3. Press CANCEL UPPER when finished proofing. Before second proofing, shape the dough, place it in baking pan(s), and cover loosely. Follow the same placement and control steps above. Before baking, remove the cover.

NOTE: If the oven temperature is greater than 120°F (49°C), the display will indicate “Oven Cooling” until the temperature is below 120°F (49°C).

Cook Time

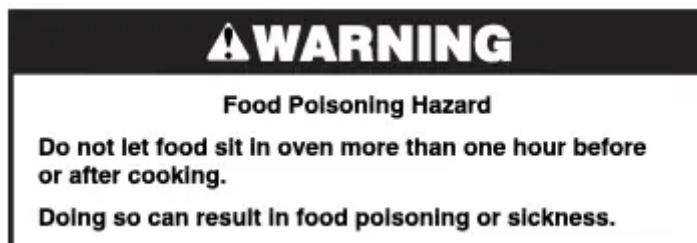

To Set a Timed Cook:

1. Press BAKE or BROIL or press an Easy Convect function.
2. Press the number keypads to enter a temperature other than the one displayed.
3. Press COOK TIME. The Cook Time oven indicator light will light up.
4. Press the number keypads to enter the length of time to cook.
5. Press START. The display will count down the time. When the time ends, the oven will shut off automatically.
6. Press CANCEL for the desired oven to clear the display.

To Set a Delayed Timed Cook:

1. Press BAKE or BROIL or press an Easy Convect function.

2. Press the number keypads to enter a temperature other than the one displayed.
3. Press COOK TIME. The Cook Time oven indicator light will light up.
4. Press number keypads to enter the length of time to cook.
5. Press DELAY START.
6. Press number keypads to enter the number of hours and/or minutes you want to delay the start time.
7. Press START. When the start time is reached, the oven will automatically turn on. The temperature and/or time settings can be changed anytime after the oven turns on by repeating steps 2 through 4. When the set cook time ends, the oven will shut off automatically.
8. Press CANCEL for the desired oven to clear the display.

Meat Probe

The meat probe accurately measures the internal temperature of meat, poultry, and casseroles with liquid and should be used in determining the doneness of meat and poultry.

This meat probe operates as an independent device and is not plugged into the oven. Follow the meat probe directions for using the meat probe.

To avoid damage to the meat probe, do not leave the meat probe in self-cleaning ovens while the cycle is running.

Baking Drawer

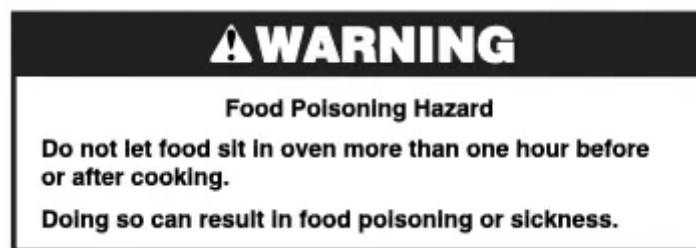

The baking drawer is highly recommended for baking frozen foods. Use the temperature and medium cook time given on the frozen food packaging. For example, if the packaging suggests a cook time of 15 to 20 minutes, set the cook time for 17 minutes. Check food for doneness before removing from the baking drawer. The baking drawer may also be used for conventional baking, slow cooking, and keeping hot cooked foods warm. It is not recommended to prepare foods taller than the height of the baking drawer rack handles or foods that may rise above 21 1/2" (6.4 cm) in the baking drawer.

IMPORTANT: Always use the baking drawer rack when using the baking drawer.



To Bake with the Baking Drawer:

1. Press BAKING DRAWER BAKE.
2. Set the desired temperature between 170°F and 451°F (75°C and 233°C) using the number keypads. The default temperature is 350°F (180°C).
3. Press START.
4. To change the temperature, repeat steps 2 and 3.
5. Press CANCEL LOWER when finished.
6. Remove food from the drawer.

To Slow Cook with the Baking Drawer:

IMPORTANT: Brown roasts thoroughly before starting to slow cook.

1. Place food in the Baking Drawer.
2. Press BAKING DRAWER SLOW COOK.
3. Set the desired temperature between 145°F and 190°F (63°C and 88°C) using the number keypads. The default temperature is 170°F (75°C).
4. Press START.
5. (Optional) Set the desired cook time using the number keypads.
6. Press START.
7. Press CANCEL LOWER when finished.
8. Remove food from the baking drawer.

To Keep Warm with the Baking Drawer:

Food must be at serving temperature before placing it in the warmed drawer.

1. Place food in the baking drawer.
2. Press BAKING DRAWER KEEP WARM.
3. Set the desired temperature between 145°F and 190°F (63°C and 88°C) using the number keypads. The default temperature is 170°F (75°C).



4. Press START.
5. Press CANCEL LOWER when finished.
6. Remove food from the baking drawer.

Oven Light

The oven light is a standard 40-watt appliance bulb. Before replacing, make sure the oven and cooktop are cool and the control knobs are in the Off position.

To Replace:

1. Unplug range or disconnect power.
2. Turn the glass bulb cover in the back of the oven counterclockwise to remove.
3. Turn bulb counterclockwise to remove from socket.
4. Replace bulb by turning clockwise.
5. Replace bulb cover by turning clockwise.
6. Plug in range or reconnect power.

RANGE CARE

Clean Cycle



AquaLift® Technology is an innovative cleaning solution that utilizes heat and water to release baked-on spills from the oven in less than 1 hour. This new cleaning technology is a low-heat, odorfree alternative to traditional Cleaning options.

Allow the oven to cool to room temperature before using the Clean cycle. If your oven cavity is above 200°F (93°C), "Oven Cooling" will appear in the display and the Clean cycle will not be activated until the oven cavity cools down.

To Clean:

1. Remove all racks and accessories from the oven cavity and wipe excess soil. Use a plastic scraper to remove easily removed soils.

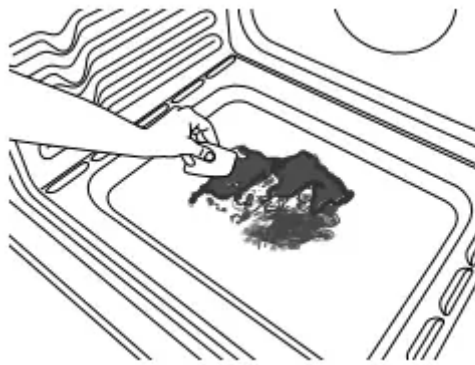

2. Pour 2 cups (16 oz [500 mL]) of distilled or filtered water onto the bottom of the empty oven and close the oven door.

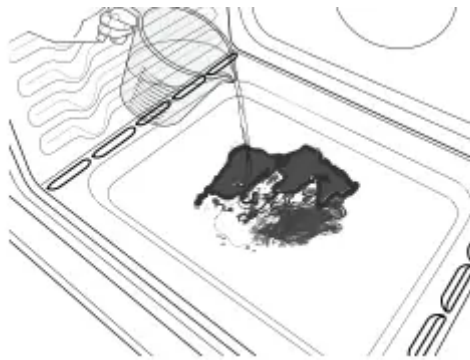

IMPORTANT: Do not use chemicals or other additives with the water. Do not open the oven door during the Clean cycle. The water on the oven bottom is hot.

3. Press AQUALIFT SELF CLEAN and then START on the oven control panel.

4. Allow 40 minutes for cleaning and cooldown. A beep will sound when the Clean cycle is complete.

5. Press CANCEL UPPER at the end of the cycle. Cancel Upper may be pressed at any time to stop the Clean cycle.

6. Remove the residual water and loosened soils with a sponge or cloth immediately after the Clean cycle is complete. Much of the initial 2 cups (16 oz [500 mL]) of water will remain in the oven after the cycle is completed. If additional soils remain, leave a small amount of water in the oven bottom to assist with the cleaning.

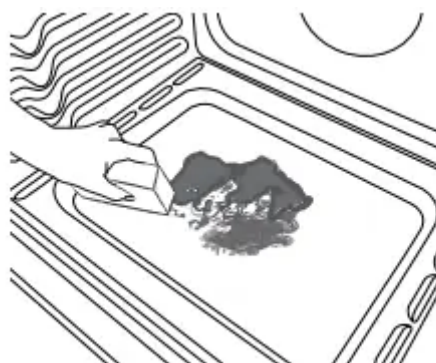

7. If any soils remain, remove them with a non-scratch scrubbing sponge or plastic scraper. Additional Clean cycles may be run to help remove the stubborn soils.

IMPORTANT: Do not use oven cleaners. The use of chemicals, including commercial oven cleaners or metal scouring pads, may cause permanent damage to the porcelain surface of the oven interior.

NOTES:

- The range should be level to ensure that the entire surface of the bottom of the oven cavity is covered by water at the beginning of the Clean cycle.
- For best results, use distilled or filtered water. Tap water may leave mineral deposits on the oven bottom.
- Before removing the residual water and loosened soils at the end of the Clean cycle, insert a cloth or paper towel between the lower edge of the oven door and the front frame to keep water from spilling onto the front of the range and the floor.
- Soil baked on through several cooking cycles will be more difficult to remove with the Clean cycle.
- Nonabrasive scrub sponges or eraser-style cleaning pads (without cleaners) can be effective for cleaning the oven cavity walls, oven door, and oven bottom for difficult soils. For best results, moisten the pads and sponges before use.
- Run an additional Clean cycle for stubborn soils.
- affresh® Kitchen Appliance Cleaner and affresh® Cooktop Cleaner may be used to clean the oven bottom, walls, and door when the oven has finished the cycle and returned to room temperature. If affresh® Cooktop Cleaner is used, it is recommended to wipe out the cavity with distilled water as well. Refer to the “Accessories” section for information on ordering.
- Additional AquaLift® Technology Cleaning Kits may be obtained by ordering Part Number W10423113RP. See the “Accessories” section for more information.

General Cleaning

EXTERIOR PORCELAIN ENAMEL SURFACES (on some models)

Food spills containing acids, such as vinegar and tomato, should be cleaned as soon as the entire range is cool. These spills may affect the finish.

Cleaning Method:

- Glass cleaner, mild liquid cleaner, or nonabrasive scrubbing pad: Gently clean around the model/serial/rating plate because scrubbing may remove numbers.
- affresh® Kitchen and Appliance Cleaner Part Number W10355010 (not included): See the “Accessories” section for more information.



STAINLESS STEEL (on some models)

NOTE: To avoid damage to stainless steel surfaces, do not use soap-filled scouring pads, abrasive cleaners, Cooktop Cleaner, steel-wool pads, gritty washcloths, or abrasive paper towels. Damage may occur to stainless steel surfaces, even with one-time or limited use.

Cleaning Method:

Rub in direction of grain to avoid damaging.

- affresh® Stainless Steel Cleaner Part Number W10355016: See the “Accessories” section for more information.

METALLIC PAINT (on some models)

Do not use abrasive cleaners, cleaners with bleach, rust removers, ammonia, or sodium hydroxide (lye) because paint surface may stain.

CERAMIC GLASS

To avoid damaging the cooktop, do not use steel wool, abrasive powder cleansers, chlorine bleach, rust remover, or ammonia.

1. Remove food/residue with the Cooktop Scraper.

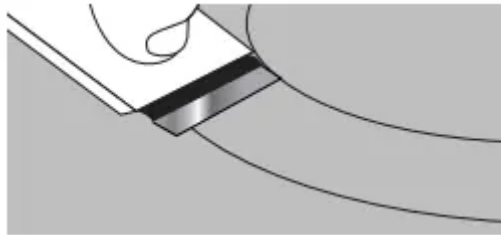

- For best results, use the Cooktop Scraper while the cooktop is still warm but not hot to the touch. It is recommended to wear an oven mitt while scraping the warm cooktop.
- Hold the Cooktop Scraper at approximately a 45° angle against the glass surface and scrape the residue. It will be necessary to apply pressure in order to remove the residue.

Allow the cooktop to cool down completely before proceeding to Step 2.

2. Apply a few dime-sized drops of affresh® Cooktop Cleaner to the affected areas.

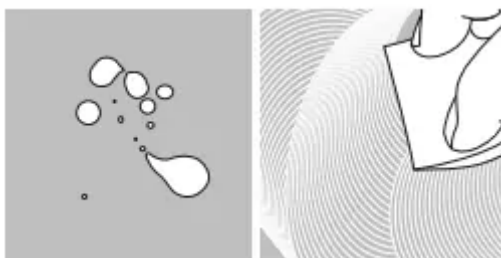

- Rub affresh® Cooktop Cleaner onto the cooktop surface with the blue Cooktop Cleaning Pad. Some pressure is needed to remove stubborn stains.

- Allow the cleaner to dry to a white haze before proceeding to Step 3.

3. Polish with a clean, dry cloth or a clean, dry paper towel.



- Repeat steps 1 through 3 as necessary for stubborn or burned-on stains.

The Complete Cooktop Cleaner Kit is available for order including the following:

- Cooktop Scraper
- affresh® Cooktop Cleaner
- Blue Cooktop Cleaning Pads See the “Accessories” section for part numbers and information on ordering.

CONTROL PANEL AND OVEN DOOR EXTERIOR

To avoid damage to the control panel, do not use abrasive cleaners, steel-wool pads, gritty washcloths, or abrasive paper towels.

Cleaning Method:

- Glass cleaner and soft cloth or sponge: Apply glass cleaner to soft cloth or sponge, not directly on panel.
- affresh® Kitchen and Appliance Cleaner Part Number W10355010 (not included): See the “Accessories” section for more information.

OVEN RACKS

Cleaning Method:

- Steel-wool pad
- For racks that have discolored and are harder to slide, a light coating of vegetable oil applied to the rack guides will help them slide.
- Dishwasher (steam rack water reservoir only, not racks): Although the water reservoir is durable, it may lose its shine and/or discolor when washed in a dishwasher.

Remove/Replace Drawer

Remove all items from inside the baking drawer, and then allow the range to cool completely before attempting to remove the drawer.

To Remove:

1. Open the drawer to its fully open position.
2. Using a flat-blade screwdriver, gently loosen the drawer from the glide alignment notch, and then lift up the drawer alignment tab from the glide.

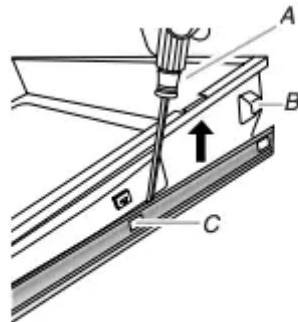

A. Flat-blade screwdriver
B. Drawer alignment tab
C. Drawer glide notch

3. Repeat Step 2 on the other side. The drawer is no longer attached to the drawer glides. Using both hands, pick up the drawer to complete the removal.

To Replace:

1. Align the forward drawer notches with the notches in the drawer glides on both sides. Place the rear alignment tabs into the drawer glides on both sides.

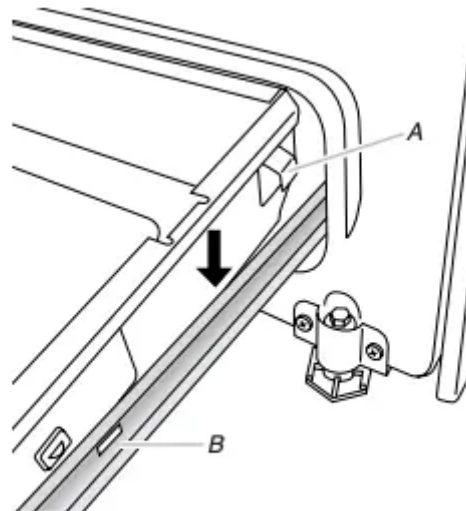

A. Drawer alignment tab
B. Drawer glide notch

2. Push the drawer in all the way.
3. Gently open and close the drawer to ensure it is seated properly on the glides on both sides.



TROUBLESHOOTING

Operation

Nothing will operate

- Power supply cord is unplugged - Plug into a grounded outlet.
- ENERGY SAVE is active, and the display is blank - Press any keypad on the control to display the time of day. See the “Electronic Oven Controls” section for more information.
- Household fuse is blown, or a circuit breaker is tripped - Replace the fuse or reset the circuit breaker. If the problem continues, call an electrician.
- The control displays an F9 or F9 E0 error code - The electrical outlet in the home may be miswired. Contact a qualified electrician to verify the electrical supply

Cooktop will not operate

- The control knob is not set correctly - Push in knob before turning to a setting.
- On ceramic glass models, the oven control lockout is set - See the control lock keypad feature in the “Feature Guide” section.

Excessive heat around cookware on cooktop

- Cookware is not the proper size - Use cookware about the same size as the surface cooking area, element, or surface burner. Cookware should not extend more than 1 cm) outside the cooking area.

Cooktop cooking results not what expected

- Control knob set to incorrect heat level - See the the “Cooktop” section.
- Range is not level - Level the range. See the Installation Instructions.

Cooktop element cycles on and off on High setting

- Element cycling due to a temperature limiter - This is normal operation. The element may cycle on and off to keep the cooktop from overheating.

Oven will not operate

- Delay Start is set - See the “Cook Time” section.
- Control Lock is ON - Press and hold START for 3 seconds to unlock.
- The range is in Demo mode - Demo mode will deactivate all oven elements. See “Demo Mode” in the Electronic Oven Controls” section.
- Electronic oven control set incorrectly - See the “Electronic Oven Controls” section.

Oven temperature too high or too low

- Oven temperature needs adjustment - See “Oven Temperature Control” in the “Electronic Oven Controls” section.

Oven indicator lights flash

Power to range is turned on or restored - See “Control Display” in the “Electronic Oven Controls” section. If the indicator lights keep flashing, call for service. See the “Warranty” section for contact information.

Display shows messages

- Power failure (display shows flashing time) - Press CANCEL to clear the display. On some models, reset the clock, if needed. See “Clock” keypad feature in the “Feature Guide” section.
- Error code (display shows letter followed by number) - Depending on your model, press CANCEL to clear the display. See “Control Display” in the “Electronic Oven Controls” section. If it reappears, call for service. See the “Warranty” section for contact information.

Clean cycle did not work on all spills

- Several cooking cycles between Clean cycles or spills on oven walls and doors - Run additional Clean cycles. Use the AquaLift® Technology Cleaning Kit. affresh® Kitchen and Appliance Cleaner or affresh® Cooktop Cleaner can be used for stubborn soils. See the “Accessories” section for more information.

Mineral deposits are left on the oven bottom after the Clean cycle

- Tap water was used in the Clean cycle - Use distilled or filtered water in the Clean cycle. To remove deposits, use a cloth soaked with vinegar. Then use a cloth dampened with water to thoroughly remove any vinegar residue.
- Range is not level - Mineral deposits will collect on dry areas of the oven bottom during the Clean cycle. Level the range. See the Installation Instructions.
- To remove deposits, use a cloth soaked with vinegar. Then use a cloth dampened with water to thoroughly remove any vinegar residue.

Oven cooking results not what expected

- Range is not level - Level the range. See the Installation Instructions.
- The set temperature was incorrect - Double-check the recipe in a reliable cookbook.
- Oven temperature needs adjustment - See “Oven Temperature Control” in the “Electronic Oven Controls” section.
- Oven was not preheated - See the “Baking and Roasting” section.
- Racks were positioned improperly - See the “Positioning Racks and Bakeware” section.
- Not enough air circulation around bakeware - See the “Positioning Racks and Bakeware” section.
- Batter distributed unevenly in pan - Check that batter is level in the pan.

- Darker browning of food caused by dull or dark bakeware - Lower oven temperature 25°F (15°C) or move rack to a higher position in the oven.
- Lighter browning of food caused by shiny or light colored bakeware - Move rack to a lower position in the oven.
- Incorrect length of cooking time was used - Adjust cooking time.
- Oven door was not closed - Be sure that the bakeware does not keep the door from closing.
- Oven door was opened during cooking - Oven peeking releases oven heat and can result in longer cooking times.
- Rack is too close to bake burner, making baked items too brown on bottom - Move rack to higher position in the oven.
- Pie crusts browning too quickly - Use aluminum foil to cover the edge of the crust and/or reduce baking temperature.

Warning

This content is compiled from multiple sources and is provided for reference purposes only. It may not be complete or fully applicable to all situations. If you are unable to resolve your issue, please contact the product manufacturer or an authorized service provider for official support.