

THIS IS INSTRUCTION MANUAL OF MICROWAVE OVEN

HORNO MICROONDAS AM720C2RA-R / AM720C2RA-A / AM720C2RA-G

SAFETY INSTRUCTIONS

To reduce the risk of burns, electric shock, fire, injury to persons or exposure to excessive microwave oven energy when using your appliance, follow basic safety precautions, including the following:

- 1** Read all instructions before using the appliance.
- 2** Read and follow the specific: " PRECAUTIONS TO AVOID POSSIBLE EXPOSURE TO EXCESSIVE MICROWAVE ENERGY"
- 3** As with most cooking appliances, close supervision is necessary to reduce the risk of a fire in the oven cavity.
- 4** To reduce the risk of fire in the oven cavity:
 - a. Do not overcook food. Carefully attend the appliance when paper, plastic, or other combustible materials are placed inside the oven to facilitate cooking.
 - b. Remove wire twist-ties and metal handles from paper or plastic containers/ bags before placing them in the oven.
 - c. If materials inside the oven ignite, keep the oven door closed. Turn the oven off, and unplug the appliance. Disconnect the power cord, shut off power at the fuse or circuit breaker panel.
 - d. Do not use the cavity for storage purposes. Do not leave paper products, cooking utensils, or food in the cavity when not in use.
- 5** This oven must be grounded. Connect only to properly grounded outlet.
- 6** Install or locate this oven only in accordance with the installation instructions provided.
- 7** Some products such as whole eggs and sealed containers-for example, closed glass jars-are able to explode and should not be heated in the oven.
- 8** Use this appliance only for its intended uses as described in this manual. Do not use corrosive chemicals or vapors in this appliance. This oven is specifically designed to heat or cook or dry food. It is not designed for industrial or laboratory use.
- 9** As with any appliance, close supervision is necessary when used by children. Do not operate this oven if it has a damaged cord or plug, if it is not working properly or if it has been damaged or dropped.
- 10** This microwave should be serviced only by qualified service personnel. Contact nearest authorized service facility for examination, repair or adjustment.
- 11** Do not cover or block any openings on the oven.

12 Do not store or use this appliance outdoors.

13 Do not use this oven near water, for example, near a kitchen sink, in a wet basement, near a swimming pool, or similar locations.

14 Do not immerse cord or plug in water.

15 Keep cord away from heated surfaces.

16 Do not let cord hang over edge of table or counter.

17 When cleaning surfaces of door and oven that comes together on closing the door, use only mild, nonabrasive soaps or detergents applied with a sponge or soft cloth.

18 This appliance is for private household use only.

19 Liquids, such as water, coffee, or tea are able to be overheated beyond the boiling point without appearing to be boiling. Visible bubbling or boiling when the container is removed from the microwave oven is not always present. THIS COULD RESULT IN VERY HOT LIQUIDS SUDDENLY BOILING OVER WHEN THE CONTAINER IS DISTURBED OR A SPOON OR OTHER UTENSIL IS INSERTED INTO THE LIQUID.

- a. Do not overheat the liquid.
- b. Stir the liquid both before and halfway through heating it.
- c. Do not use straight-sided containers with narrow necks.
- d. After heating, allow the container to stand in the microwave oven for a short time before removing the container.
- e. Use extreme care when inserting a spoon or other utensil into the container.

GROUNDING INSTRUCTIONS

DANGER Electric Shock Hazard

Touching some of the internal components can cause serious personal injury or death. Do not disassemble this appliance.

This appliance must be grounded. In the event of an electrical short circuit, grounding reduces the risk of electric shock by providing an escape wire for the electric current. To protect against electrical shock, this appliance is equipped with a cord having a 3 prong grounding-type plug for insertion into a proper grounding-type receptacle. DO NOT alter the plug for use in a 2-prong receptacle. If the plug will not fit into a receptacle, have the proper receptacle installed by a qualified electrician.

CAUTION: Do not insert your fingers into any gaps or holes; it may cause injuries.

WARNING

Improper use of the grounding can result in a risk of electric shock

Consult a qualified electrician or serviceman if the grounding instructions are not completely understood or if doubt exists as to whether the appliance is properly grounded. If it is necessary to use an extension cord, use only a 3-wire extension cord that has a 3-pronged grounding plug, and a 3-slot receptacle that will accept the plug on the appliance. The marked rating of the extension cord shall be equal to or greater than the electrical rating of the appliance.

1. A short power-supply cord is provided to reduce the risks resulting from becoming entangled in or tripping over a longer cord.
2. Longer cord sets or extension cords are available and may be used if care is exercised in their use.
3. If a long cord sets or extension cord is used:
 - The marked electrical rating of the cord set or extension marked electrical rating of the cord set or extension cord should be at least as great as the electrical rating of the appliance.
 - The extension cord must be a grounding -type 3-wire cord.
 - The longer cord should be arranged so that it will not drape over the countertop or tabletop where it can be pulled on by children or tripped over unintentionally

RADIO INTERFERENCE

Operation of the microwave oven may cause interference to your radio, TV or similar equipment.

When there is interference, it may be reduced or eliminated by taking the following measures:

1. Clean door and sealing surface of the oven.
2. Reorient the receiving antenna of radio or television.
3. Relocate the microwave oven with respect to the receiver.
4. Move the microwave oven away from the receiver.
5. Plug the microwave oven into a different outlet so that microwave oven and receiver are on different branch circuits.

UTENSILS

CAUTION *Electric Shock Hazard*

Tightly-closed utensils could explode. Closed containers should be opened and plastic pouches should be pierced before cooking.

See the instructions on "Materials you can use in microwave oven or to be avoided in microwave oven." There may be certain non-metallic utensils that are not safe to use for microwaving. If in doubt, you can test the utensil in question following the procedure below.

UTENSIL TEST

1. Fill a microwave-safe container with 1 cup of cold water (250ml) along with the utensil in question.
2. Cook on maximum power for 1 minute.
3. Carefully feel the utensil. If the empty utensil is warm, do not use it for micro wave cooking.
4. Do not exceed 1 minute cooking time.

MATERIALS YOU CAN USE IN MICROWAVE OVEN

Browning dish	Follow manufacturer's instructions. The bottom of browning dish must be at least 3/16 inch (5mm) above the turntable. Incorrect usage may cause the turntable to break.
Dinnerware	Microwave-safe only. Follow manufacturer's instructions. Do not use cracked or chipped dishes.
Glass jars	Always remove lid. Use only to heat food until just warm. Most glass jars are not heat resistant and may break
Glassware	Heat-resistant oven glassware only. Make sure there is no metallic trim. Do not use cracked or chipped dishes.
Oven cooking bags	Follow manufacturer's instructions. Do not close with metal tie. Make slits to allow steam to escape.
Paper plates and cups	Use for short-term cooking/warming only. Do not leave oven unattended while cooking
Paper towels	Use to cover food for reheating and absorbing fat. Use with supervision for a short-term cooking only.
Parchment paper	Use as a cover to prevent splattering or a wrap for steaming.
Plastic	Microwave-safe only. Follow the manufacturer's instructions. Should be labeled "Microwave Safe". Some plastic containers soften, as the food inside gets hot. "Boiling bags" and tightly closed plastic bags should be slit, pierced or vented as directed by package.
Plastic wrap	Microwave-safe only. Use to cover food during cooking to retain moisture. Do not allow plastic wrap to touch food.
Thermometers	Microwave-safe only (meat and candy thermometers)
Wax paper	Use as a cover to prevent splattering and retain moisture.

MATERIALS TO BE AVOIDED IN MICROWAVE OVEN

Aluminum tray	May cause arcing. Transfer food into microwave-safe dish.
Food carton with metal handle	May cause arcing. Transfer food into microwave-safe dish.
Metal or metal trimmed utensils	Metal shields the food from microwave energy. Metal trim may cause arcing.
Metal twist ties Paper bags	May cause arcing and could cause a fire in the oven. May cause a fire in the oven.
Plastic foam	Plastic foam may melt or contaminate the liquid inside when exposed to high temperature.
Wood	Wood will dry out when used in the microwave oven and may split or crack.

SETTING UP YOUR OVEN

Names of Oven Parts and Accessories

Remove the oven and all materials from the carton and oven cavity. Your oven comes with the following accessories:

Glass tray x1 Turntable ring assembly x1 Instruction Manual x1

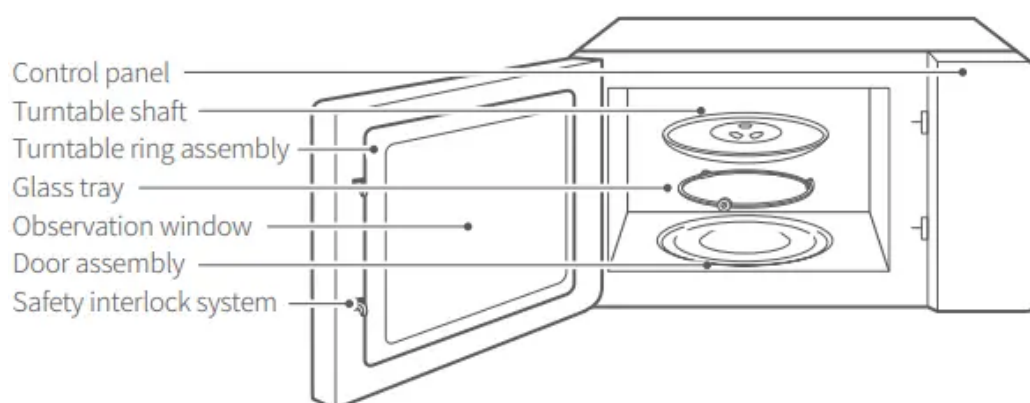

Turntable installation

- Never place the glass tray upside down. The glass tray should never be restricted.
- Both glass tray and turntable ring assembly must always be used during cooking.
- All food and containers of food are always placed on the glass tray for cooking.

- If glass tray or turntable ring assembly cracks or breaks, contact your nearest authorized service center.

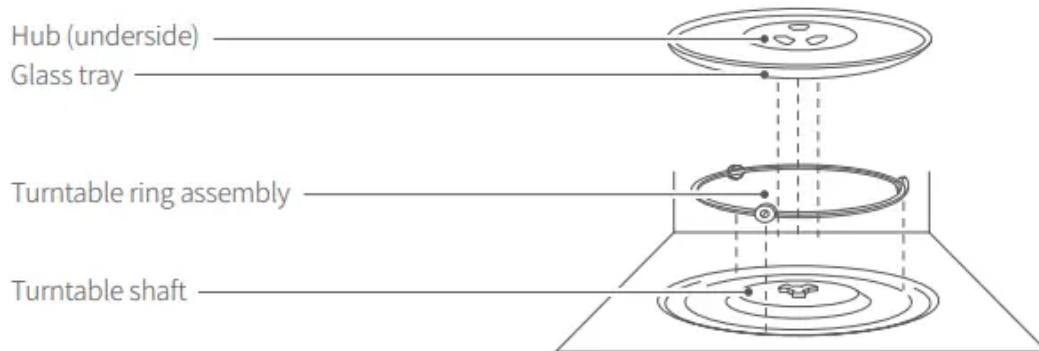

COUNTERTOP INSTALLATION

Remove all packing material and accessories. Examine the oven for any damage such as dents or broken door. Do not install if oven is damaged.

Cabinet: Remove any protective film found on the microwave oven cabinet surface. Do not remove the light brown Mica cover that is attached to the oven cavity to protect the magnetron.

INSTALLATION

1. A minimum clearance of 3.0 inches (7.5cm) is required between the oven and any adjacent walls. One side must be open.

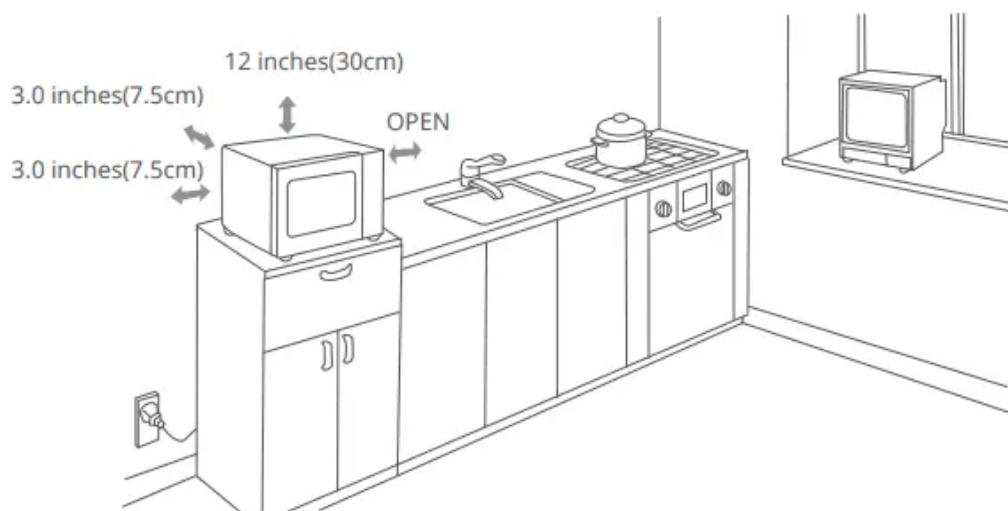

A minimum clearance of 3.0 inches (7.5cm) is required between the oven and any adjacent walls. One side must be open.

- a. Leave a minimum clearance of 12 inches (30cm) above the oven.

- b. Do not remove the legs from the bottom of the oven.
 - c. Blocking the intake and/or outlet openings can damage the oven.
 - d. Place the oven as far away from radios and TV as possible. Operation of micro wave oven may cause interference to your radio or TV reception.
2. Plug your oven into a standard household outlet. Be sure the voltage and the frequency is the same as the voltage.









WARNING

Do not install oven over a range cooktop or other heat-producing appliance. If installed near or over a heat source, the oven could be damaged and the warranty would be void.



Control Panel

Meaning



	Kitchen Timer / Clock
	Weight
	Auto Menu
	Microwave
	Defrost
	Stop/Clear
	Start/+30Sec.
	Sound On/Off







OPERATION INSTRUCTION

Clock Setting

When the microwave oven is electrified, the oven will display "0:00", buzzer will ring once.





1. Press " | 
 twice, the hour figures will flash.
2. Turn "
 to adjust the hour figures, the input time should be within 1-12.

3. Press " | ", the minute figures will flash.
4. Turn " " to adjust the minute figures, the input time should be with in 0--59.
5. Press " |  " to finish clock setting. ":" will flash.

NOTE







- If the clock is not set, it would not function when powered.
- During the process of clock setting, if you press ""
- or no operation in one minute, the oven will exit the setting

Kitchen Timer

1. Press " |  " once, the screen will display "00:00".
2. Turn " " to enter the correct timer. (The maximum cooking time is 95 minutes,)
3. Press " " , to confirm setting.
4. When the kitchen time is reached, clock indicator will go out. The buzzer will ring 5 times. If the clock has been set (12-hour system), screen will display the current time.

NOTE The kitchen Time is different from 12-hour system. Kitchen Timer is a timer.

Microwave Cooking

1. Press the " " key once, and "P100" display.
2. Press " " repeatedly or turn " " to select the microwave power "PL10", "PL9", "PL8", "PL7", "PL6", "PL5", "PL4", "PL3", "PL2", "PL1", will display in order.
3. Press " " to confirm.
4. Turn " " to adjust the cooking time. (The time setting should be 0:05- 95:00.)
5. Press " " to start cooking.

NOTE The step quantities for the adjustment time of the coding switch are as follow:

0---1 min	5 seconds	10---30 min	1 minute
1---5 min	10 seconds	30---95 min	5 minutes
5---10 min	30 seconds		

Microwave Power Chart





Press	Once	Twice	Thrice	4 times	5 times
Microwave Power	100%	90%	80%	70%	60%
Display	PL10	PL9	PL8	PL7	PL6

Press	6 times	7 times	8 times	9 times	10 times
Microwave Power	50%	40%	30%	20%	10%
Display	PL5	PL4	PL3	PL2	PL1



Speedy Cooking

NOTE

Under the state of auto menu or weight defrost, cooking time cannot be increased by pressing "".



1. In waiting state, press "" key to cook with 100% power level for 30 seconds. Each press on the same key can increase 30 seconds. The maximum cooking time is 95 minutes.
2. During the microwave cooking and time defrost process, press "" to increase the cooking time.
3. In waiting state, turn "" left to choose the cooking time directly. After choosing the time, press "" to start cooking. The microwave power is 100%.

DEFROST BY WEIGHT

1. Press "" once, the screen will display "dEF1".
2. Turn "" to select the food weight. The range of weight is 4-54Oz.
3. Press "" key to start defrosting.

Defrost By Time

NOTE The defrost power is PL 3. And it cannot be changed.

1. Press "" twice, the screen will display "dEF2".
2. Turn "" to select the cooking time.







3. Press " " key to start defrosting.

Multi-Stage Cooking





NOTE Auto menu cannot be set as one of the multi-stage.

Two stages can be maximumly set. If one stages is defrosting, it should be put in the first stage. The buzzer will ring once after each stage and the next stage will begin.



Example: if you want to defrost the food for 5 minutes, then to cook with 80% microwave power for 7 minutes. The steps are as following:

1. Press " " twice, the screen will display "DEF2".
2. Turn " " to adjust the defrost time of 5 minutes;
3. Press " " once; the screen display "PL 10".
4. Turn " " to choose 80% microwave power till "PL 8" display;
5. Press " " to confirm;
6. Turn " " to adjust the cooking time of 7 minutes;
7. Press " " to start cooking.



Auto Menu

1. In waiting states, turn " " right to choose the menu from "A-1" to "A-9" or turn left to choose the menu from "A-9" to "A-1"
2. Press " " to confirm the menu you choose;
3. Turn " " to choose the food weight;
4. Press " " to start cooking;
5. After cooking finish, the buzzer sounds five times.



Inquiring Function

1. In cooking state of microwave, press " " , the current power will be displayed for 3 seconds.
2. During cooking state, press " |  3Sec." to check the current time. It will be displayed for 3 seconds.



Lock-out Function for Children

- **Lock:** In waiting state, press " " for 3 seconds, there will be a long "beep" denoting entering the children-lock state.
- **Lock quitting:** In locked state, press " " for 3 seconds, there will be a long "beep" denoting that the lock is released.

Specification

1. The buzzer will sound once when turning the knob at the beginning;
2. " " must be pressed to continue cooking if the door is opened during cooking;
3. Once the cooking programme has been set, " " is not pressed in 1 minute. The current time will be displayed. The setting will be cancelled.
4. The buzzer sounds once by efficient press, inefficient press will be no response.
5. The buzzer will sound five times to remind you when cooking is finished.

Mute function

1. In waiting state, press " |  3Sec." for 3 seconds to release, switch the sound status, On → Off or Off → On
2. All buttons and cooking beep are turned off in silent mode.

ECO function

1. In waiting state, press the " " button to release (less than 3 seconds) and the display will turn off.
2. After the display is closed, press any button, switch door or knob to wake up the display and beep once.
3. The ECO function cannot be entered when the door is opened or the Look-out Function is locked.

Turntable reset function

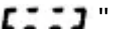
When cooking finished, if the turntable is not at the initial position, it will enter the turntable reset function. At this time, the lamp, fan and turntable are working, " " will dynamic display. After the turntable has reset, the oven stops cooking and reminds cooking finished.

NOTE

This function only works for one completed cooking. If pause or open the door during cooking, the current cooking cannot enter the turntable reset function.

TROUBLESHOOTING



Trouble	Possible Cause	Remedy
Oven will not start	Electrical cord for oven is not plugged in. Door is open. Wrong operation is set	Plug into the outlet. Close the door and try again. Check instructions
Arcing or sparking	Materials to be avoided in microwave oven were used. The oven is operated when empty. Spilled food remains in the cavity.	Use microwave-safe cookware only. Do not operate with oven empty. Clean cavity with wet towel.
Unevenly cooked foods	Materials to be avoided in microwave oven were used. Food is not defrosted completely. Cooking time, power level is not suitable. Food is not turned or stirred.	Use microwave-safe cookware only. Completely defrost food. Use correct cooking time, power level. Turn or stir food.
Overcooked foods	Cooking time, power level is not suitable.	Use correct cooking time, power level.
Undercooked foods	Materials to be avoided in microwave oven were used. Food is not defrosted completely. Oven ventilation ports are restricted. Cooking time, power level is not suitable.	Use microwave-safe cookware only. Completely defrost food. Check to see that oven ventilation ports are not restricted. Use correct cooking time, power level.
Improper defrosting	Materials to be avoided in microwave oven were used. Cooking time, power level is not suitable.	Use microwave-safe cookware only. Use correct cooking time, power level.

	Food is not turned or stirred.	Turn or stir food
Sensor cooked foods not properly cooked	Cover or lid on food not vented. Door opened before sensor-detect - ed cooking time appears in display.	Cover or lid over food must contain vent hole for escaping steam. Do not open door to stir or turn food

Warning

This content is compiled from multiple sources and is provided for reference purposes only. It may not be complete or fully applicable to all situations. If you are unable to resolve your issue, please contact the product manufacturer or an authorized service provider for official support.

