

USER MANUAL Iron

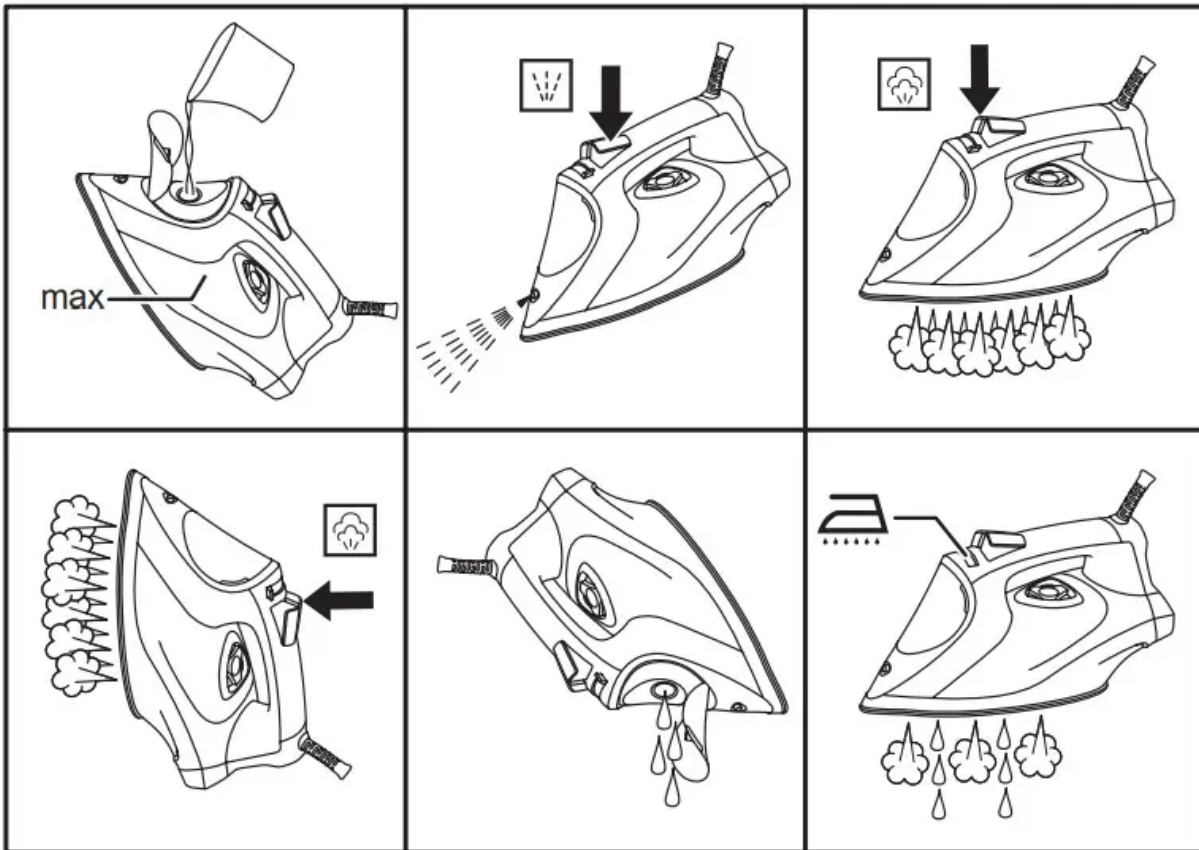

DIAGRAMS

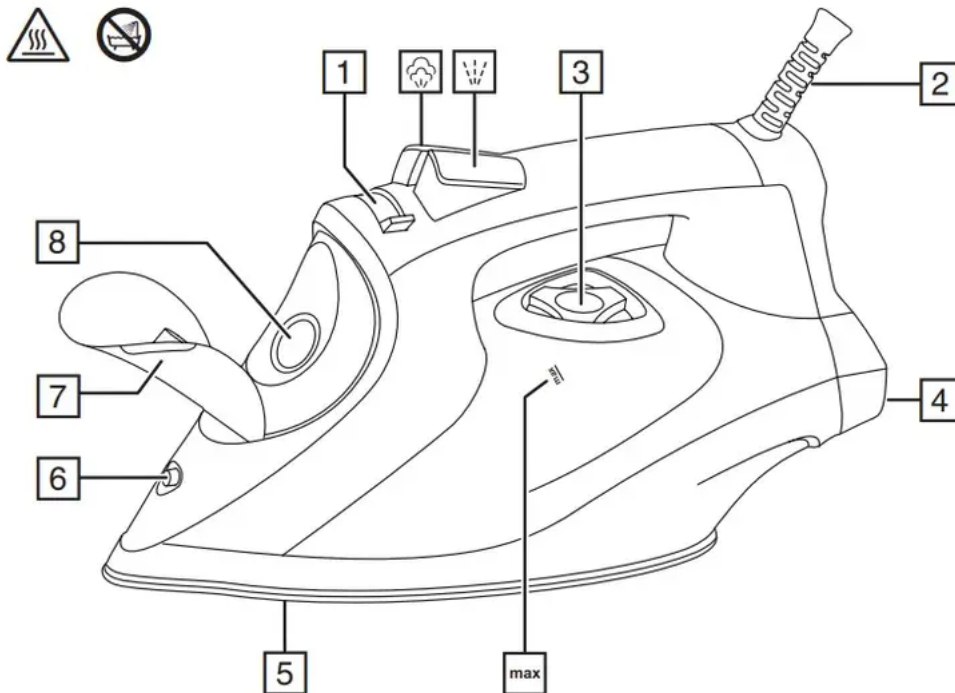

1. Steam control
2. Swivel cord
3. Light
4. Heel
5. Soleplate
6. Spray nozzle
7. Cover
8. Water inlet

BEFORE FIRST USE

- Remove any labels, stickers or packaging from the iron and soleplate.
- Before using the iron for the first time, or if it's not been used for a long time, iron a scrap piece of cotton (an old towel is ideal) to remove any accumulated residues.
- Don't worry if the iron smokes a bit at first, it will soon stop as the manufacturing residues evaporate.

FILLING

You may use the iron with tap-water, but if you live in a hard water area, you should use distilled water (not chemically descaled or softened water). If you buy distilled water, check that it's suitable for use in irons.

1. Unplug the iron.
2. Hold the iron with the front raised.
3. Open the water inlet cover.
4. Pour slowly, to let the air in the reservoir escape, otherwise you'll cause an air lock and the water will overflow.
5. Don't fill past the max marking or water will escape in use.
6. Wipe up any spillage.

USING



The temperature of your iron is safe to use on all ironable fabrics and garments.

Dry Ironing

If you're going to be dry ironing for 20 minutes or more, empty the reservoir first to avoid spontaneous bursts of steam.

1. Put the plug into the power socket (switch the socket on, if it's switchable).
2. Set the steam control to  .
3. The light will slowly pulse on and off as your iron heats up. When your iron is ready to use, the light will stay on.

Steam Ironing

1. Set the steam control to the setting you want,  = no steam,  = high steam.
2. The light will slowly pulse on and off as your iron heats up. When your iron is ready to use, the light will stay on.

SPRAY

Water can affect some fabrics. Test this out on a hidden part of the fabric.

1. Lift the iron off the fabric.
2. Aim the spray nozzle at the fabric.

3. Press the  button – you may have to press it 2 or 3 times to pump water through the system.

SHOT OF STEAM

1. Lift the iron off the fabric.
2. Press the  button.
3. Leave 4 seconds between shots to let the temperature build up.

VERTICAL STEAMING

Remove wrinkles from hanging clothes, hanging curtains, and furnishing fabrics.

- Check that there's adequate ventilation behind the fabric, otherwise moisture may build up, causing mildew.
 - Check that there's nothing behind the fabric that may be damaged by the steam.
 - Check that pockets, turn-ups, and cuffs are empty
1. Hold the iron close to (but not touching) the fabric. Hold it well away for delicate fabrics.
 2. Press the  button.
 3. Leave 4 seconds between shots to let the temperature build up.

AUTO SHUT-OFF

If the iron is motionless, it will switch off after about 30 seconds with the soleplate down or on its side, or about 8 minutes if it's upright.

- Your iron will beep 6 times and the light will flash continuously until you move the iron.
- To switch the iron on again, lift it up, tilt it forward, then sit it upright to return to operating temperature.

AFTER USE



1. Set the steam control to .
2. Unplug the iron.
3. Open the water inlet cover.
4. Hold the iron over a sink, turn it upside down and drain the water from the reservoir.
5. Stand the iron on its heel and leave it to cool down completely.

6. When cold, wipe off any moisture and close the water inlet cover.
7. Wipe outer surfaces with a damp cloth.
8. Remove spots from the soleplate with a little vinegar – take care not to scratch it.
9. Store the iron on its heel, to avoid corrosion and damage to the soleplate.

SELF CLEAN

To avoid scale build up, use the self clean function at least monthly in normal water areas, more often in hard water areas.

You'll need a basin or a large bowl to catch the water coming out of the soleplate.

1. Fill the reservoir to the max mark.
2. Set the steam control to .
3. Stand the iron on its heel.
4. Plug your iron in and wait for the light to stop flashing and stay on.
5. Hold the iron over the basin or bowl, with the soleplate down.
6. Move the steam control to the  position and hold it there.
7. Gently move the iron to and fro, over the basin or bowl.
8. Water and steam will wash scale and dust through the soleplate, and into the sink.
9. When the reservoir is empty, release the  button.
10. Unplug the iron, and stand it on its heel to cool.
11. Follow the steps under AFTER USE.

IMPORTANT SAFEGUARDS

This appliance can be used by children aged from 8 years and above and persons with reduced physical, sensory or mental capabilities or lack of experience and knowledge if they have been supervised/instructed and understand the hazards involved. Children shall not play with the appliance. Cleaning and user maintenance shall not be done by children unless they are older than 8 and supervised. Keep the iron and cable out of reach of children under 8 years.

Sit the base unit on a stable, level, heat-resistant surface, preferably a purpose-built “steam station” type ironing board.

Rest the iron only on the base unit.

Don't leave the iron unattended while plugged in or standing on the ironing board. It could be knocked over.

Don't use the iron if it's dropped, damaged, malfunctions or leaks.

If the cable is damaged, return the iron, to avoid hazard.



The surfaces of the appliance will get hot.



Do not use this appliance near bathtubs, showers, basins or other vessels containing water.

- Don't iron clothing while it's being worn – you'll injure the wearer.
- Don't use the appliance for any purpose other than those described in these instructions.
- Don't scratch the soleplate – avoid buttons, zips, etc.
- The appliance has a protective thermal fuse, which will blow if it overheats. If this happens, the appliance will stop working, and must be returned for repair.

Warning

This content is compiled from multiple sources and is provided for reference purposes only. It may not be complete or fully applicable to all situations. If you are unable to resolve your issue, please contact the product manufacturer or an authorized service provider for official support.