

## Parts

### Control Panel

The color and shape of parts may differ from what is shown. Specifications are subject to change without notice to improve quality.

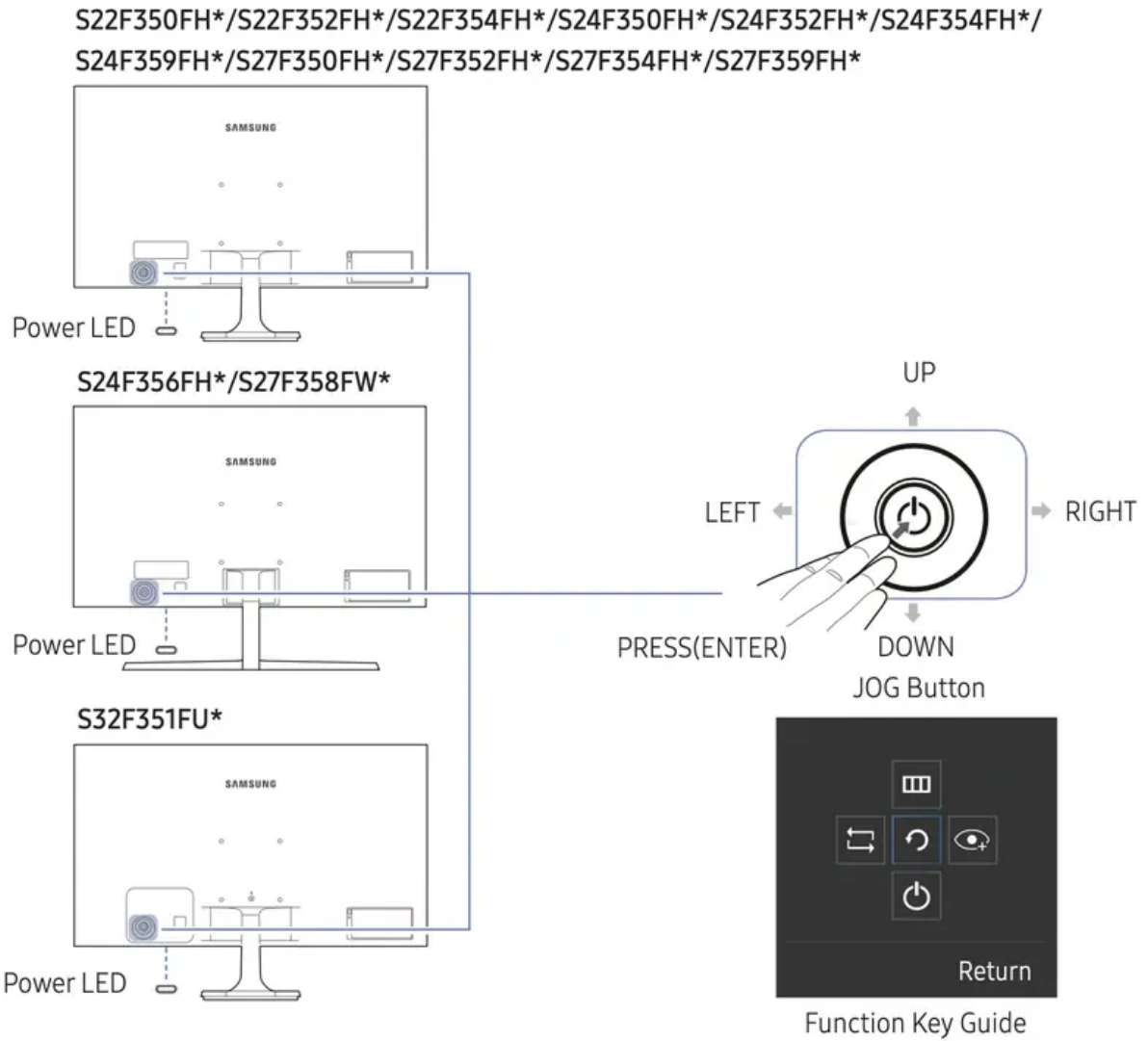

Icons	Description
JOG Button	<p>Multi directional button that helps navigate.</p> <ul style="list-style-type: none"> <li>• The JOG button is located on the rear left side of the product. The button can be used to move up, down, left or right, or as Enter.</li> </ul>
Power LED	<p>This LED is power status indicator and works as</p> <ul style="list-style-type: none"> <li>• Power On (Power button): Off</li> <li>• Power saving mode: Blinking</li> <li>• Power Off (Power button): On <ul style="list-style-type: none"> <li>◦ The power Indicator operation can be swapped by changing in the menu. (System &gt; Power LED On) Actual models because of functional variation maybe haven't this function.</li> </ul> </li> </ul>
Function Key Guide	<p>Press the JOG button when the screen is turned on. The Function Key Guide will appear. To access the onscreen menu when the guide is displayed, press the corresponding direction button again.</p> <ul style="list-style-type: none"> <li>• Function Key Guide may vary depending on the function or product model. Please refer to the actual product.</li> </ul>

## Direct Key guide

- The shortcut button screen (OSD menu) shown below is displayed only when the monitor screen is turned on, the computer resolution changes, or the input source changes.
- The function buttons page shows if Eye Saver Mode is enabled.







: On

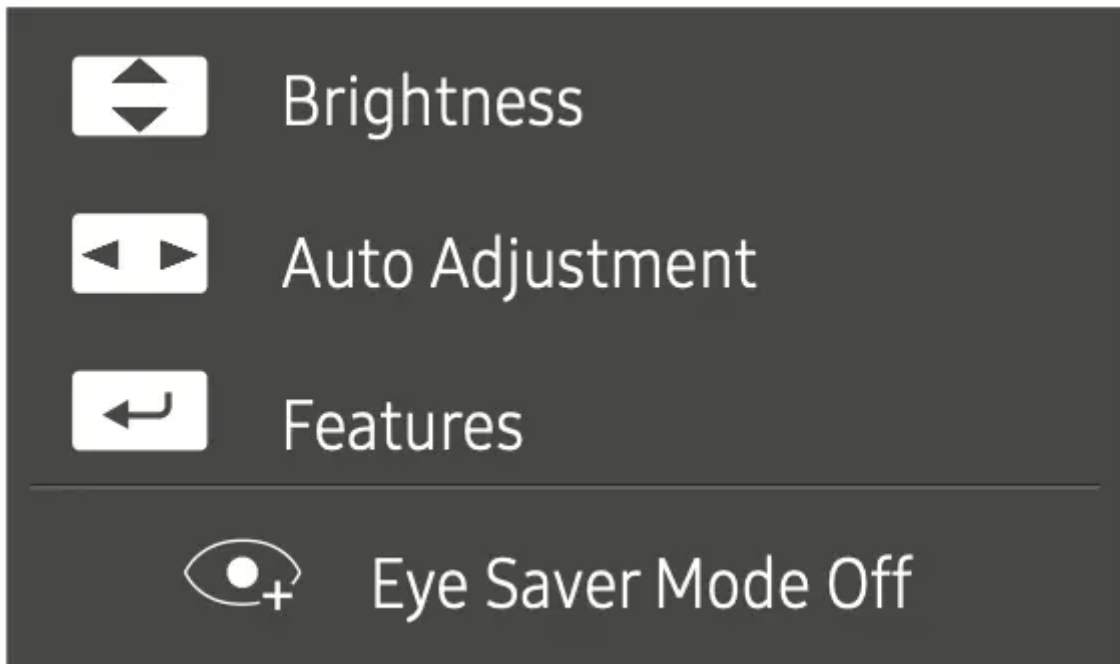

: Off



-  /  : Adjust Brightness, Contrast, Sharpness.
-  : Adjust Auto Adjustment.
  - Changing the resolution in Display Properties will activate the Auto Adjustment function.
  - This function is only available in Analog mode.
-  : Display Function Key Guide.





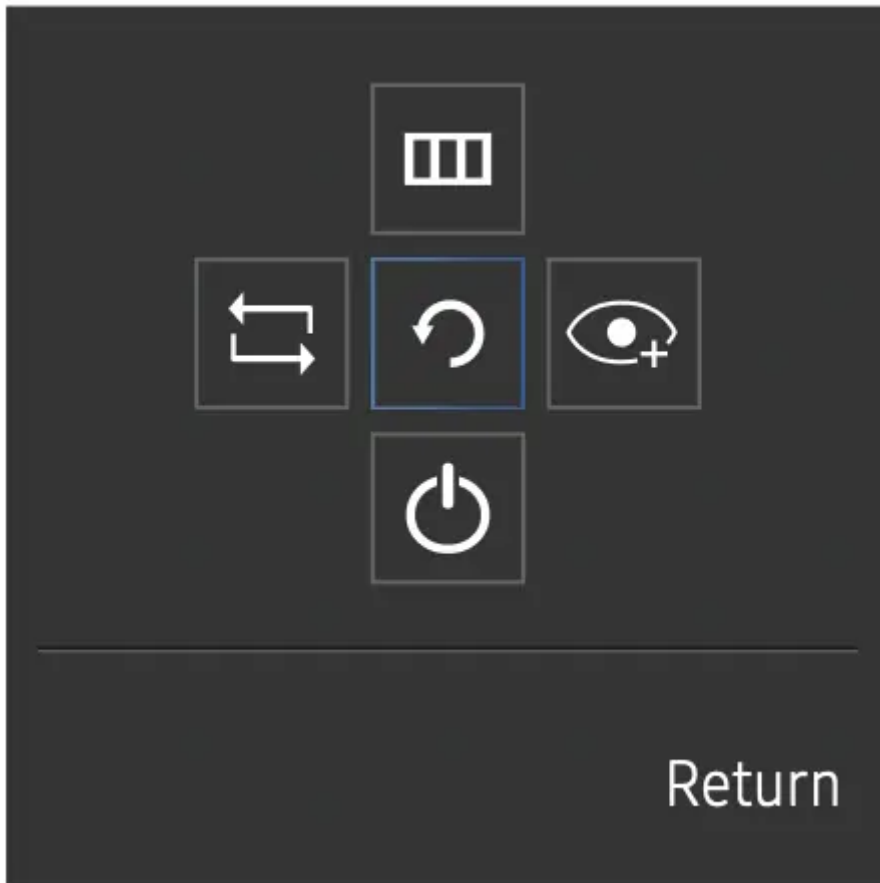



## Function Key Guide

To enter the main menu or to use other items, press the JOG button to display the Function Key Guide. You can exit by pressing the JOG button again.



UP/DOWN/LEFT/RIGHT: Move to the item you want. The description for each item will appear when the focus changes.

PRESS(ENTER): The selected item will be applied.

Icons	Description
	<p>Selects  to change the input signal by moving the JOG button in the Function Key Guide screen. A message will appear on the top left corner of the screen if the input signal has been changed.</p>
	<p>Selects  by moving the JOG button in the function key guide screen.</p> <p>The OSD (On Screen Display) of your Monitor's feature appears.</p> <p>OSD control lock: Maintain the current settings, or lock the OSD control to prevent unintended changes to settings. Enable/Disable: To lock/unlock the OSD control, press the LEFT button for 10 seconds when the main menu displayed.</p> <ul style="list-style-type: none"> <li>• If the OSD control is locked, Brightness and Contrast can be adjusted. Eye Saver Mode is available. System &gt; Power LED On is available. Information can be viewed.</li> </ul>
	<p>Selects  by moving the JOG button in the function key guide screen.</p> <p>Press to enable or disable Eye Saver Mode.</p> <p>The items below are not available if the Eye Saver Mode function is enable.</p> <ul style="list-style-type: none"> <li>• Picture &gt;  Bright, Brightness, Color, Game Mode</li> <li>• System &gt; Eco Saving Plus</li> </ul>
	<p>Selects  to turn the Monitor off by moving the JOG button in the function key guide screen.</p>

When the monitor displays nothing (i.e. Power saving mode or Non-signal mode), 2 direct keys for control source and power could be used as below.

JOG Button	Power saving/Non-signal mode
UP	Source Change
Down	
PRESS(ENTER) for 2 seconds	Power Off

When the monitor displays the Main menu the JOG Button could be used as below.

JOG Button	Action
UP/DOWN	Move the option
LEFT	Exit the Main menu. Close Sublist without saving value. Value decreases in the slider.
RIGHT	Move to next depth. Value increases in the slider.
PRESS(ENTER)	Move to next depth. Save the value and close Sublist.

### Changing Brightness, Contrast and Sharpness settings

You can adjust Brightness, Contrast or Sharpness by moving the JOG button up or down, if no OSD menu is displayed.



- The displayed image may differ depending on the model.
- The default brightness can vary depending on the region.

#### Brightness

- This menu is not available when  Bright is set to Dynamic Contrast mode.
- This menu is not available when Eco Saving Plus is enabled.
- This menu is not available when Eye Saver Mode is enabled.

#### Contrast

- This menu is not available when  Bright is in Cinema or Dynamic Contrast mode.
- This menu is not available when Game Mode is enabled.

## Sharpness





- This menu is not available when **SAMSUNG MAGIC** Bright is in Cinema or Dynamic Contrast mode.
- This menu is not available when **SAMSUNG MAGIC** Upscale is in Mode1 or Mode2 mode.
- This menu is not available when Game Mode is enabled.

## Reverse Side

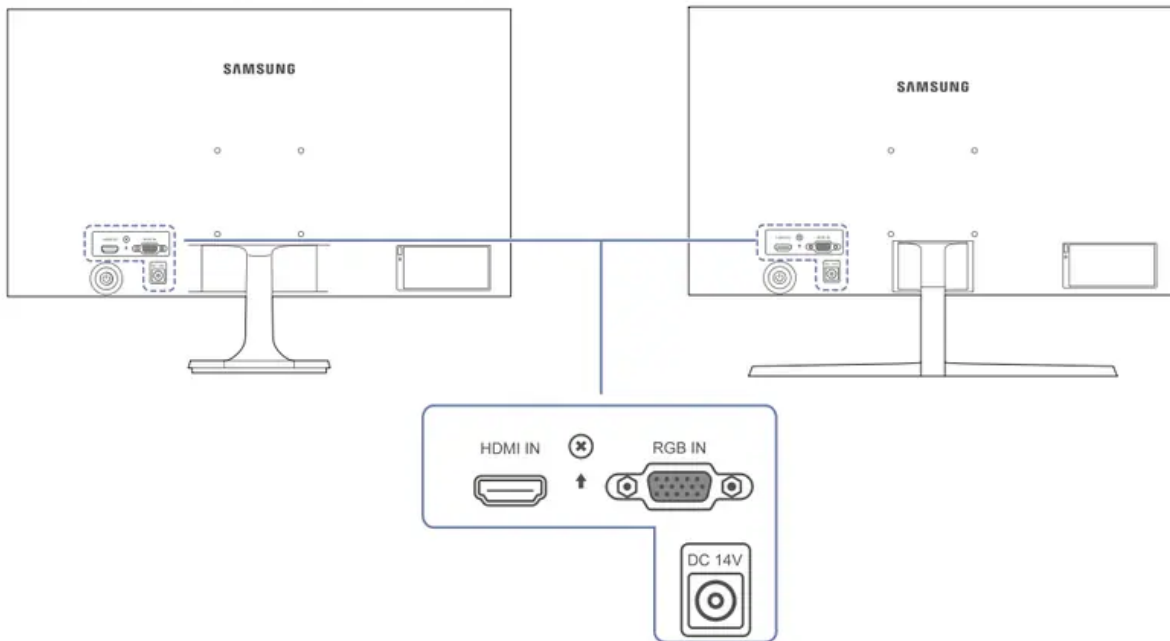
The color and shape of parts may differ from what is shown. Specifications are subject to change without notice to improve quality.

S22F350FH\*/S22F352FH\*/S22F354FH\*/S24F350FH\*/ S24F356FH\*  
 S24F352FH\*/S24F354FH\*/S24F359FH\*/S27F350FH\*/  
 S27F352FH\*/S27F354FH\*/S27F359FH\*



Port	Description
  	Connects to a source device using an HDMI cable or HDMI-DVI cable.
	Connect to a PC using the D-SUB cable.

## Adjusting the Product Tilt

The color and shape of parts may differ from what is shown. Specifications are subject to change without notice to improve quality.

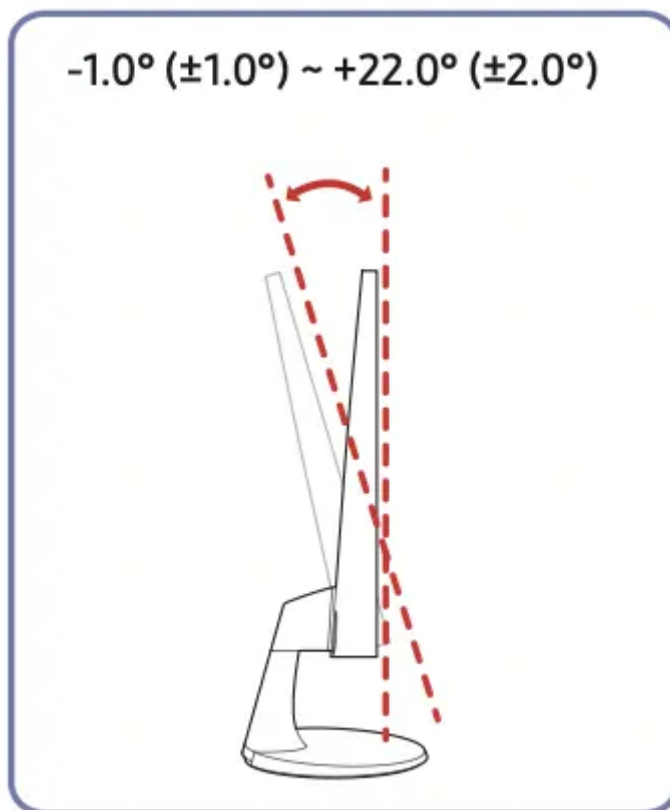

- You can adjust the product tilt.
- Hold the lower part of the product and adjust the tilt carefully.

## Anti-theft Lock

An anti-theft lock allows you to use the product securely even in public places.

The locking device shape and locking method depend on the manufacturer. Refer to the user guide provided with your anti-theft locking device for details.

**To lock an anti-theft locking device:**

S22F350FH\*/S22F352FH\*/  
S22F354FH\*/S24F350FH\*/  
S24F352FH\*/S24F354FH\*/  
S24F359FH\*/S27F350FH\*/  
S27F352FH\*/S27F354FH\*/  
S27F359FH\*

S24F356FH\*/S27F358FW\*

S32F351FU\*

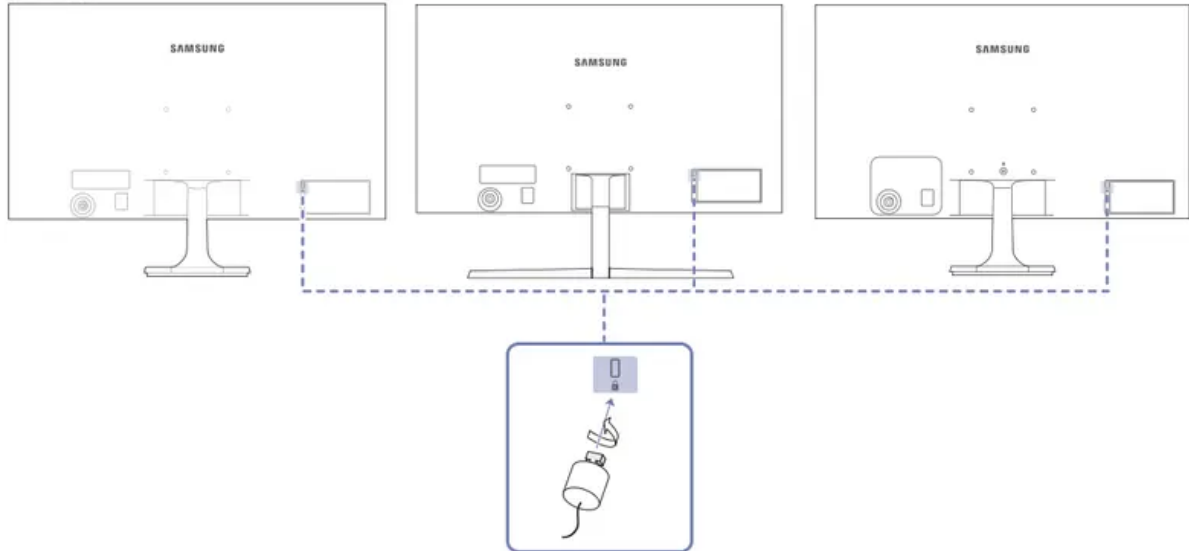

1. Fix the cable of your anti-theft locking device to a heavy object such as a desk.
  2. Put one end of the cable through the loop on the other end.
  3. Insert the locking device into the anti-theft lock slot at the back of the product.
  4. Lock the locking device.
- An anti-theft locking device can be purchased separately.
  - Refer to the user guide provided with your anti-theft locking device for details.
  - Anti-theft locking devices can be purchased at electronics retailers or online.

## Installing a Wall-mount Kit or Desktop Stand

Power the product off and remove the power cable from the power socket.

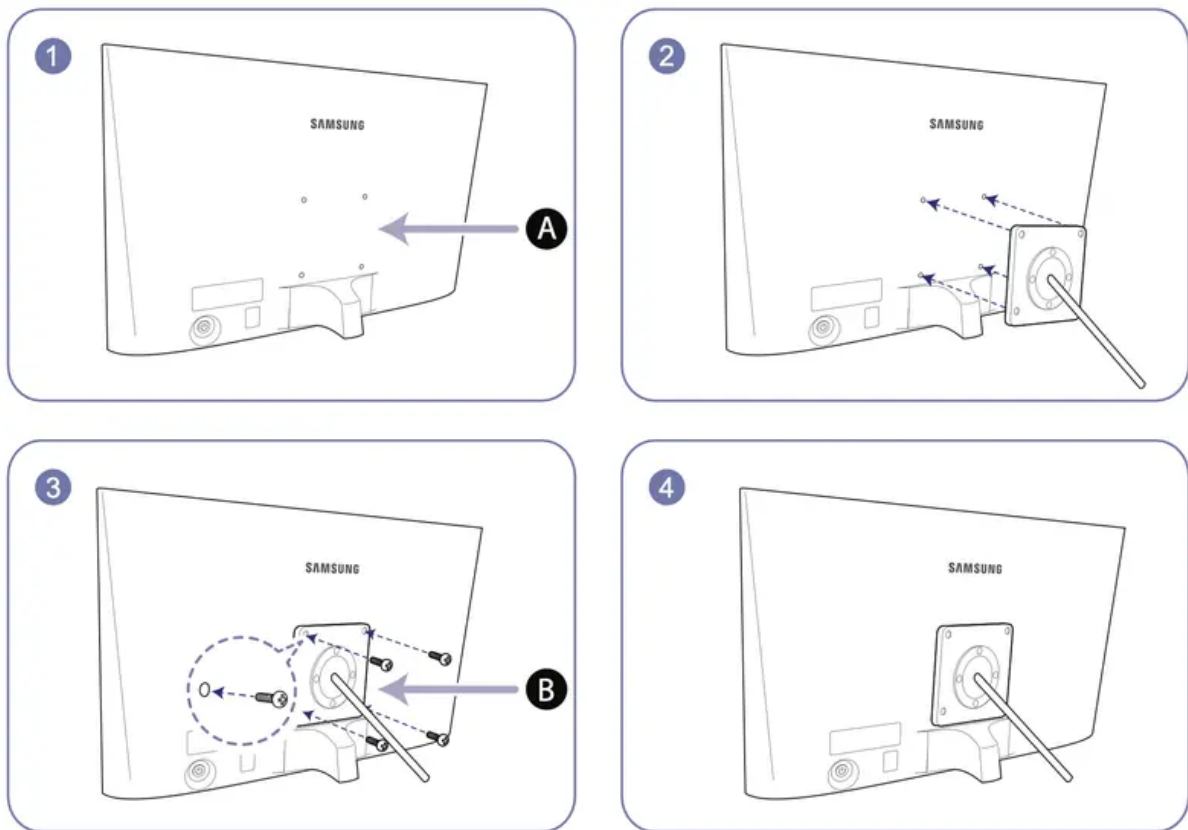

A. Attach the wall-mount kit or desktop stand here

B. Bracket (sold separately)

Align the grooves and tightly fasten the screws on the bracket on the product with the corresponding parts on the wall-mount kit or desktop stand you want to attach.

### Notes

- Using a screw longer than the standard length can damage the internal components of the product.
- The length of screws required for a wall mount that does not comply with the VESA standards may vary depending on the specifications.
- Do not use screws that do not comply with the VESA standards. Do not attach the wall-mount kit or desktop stand using excessive force. The product may get damaged or fall and cause personal injury. Samsung shall not be held liable for any damage or injury caused by using improper screws or attaching the wall-mount kit or desktop stand using excessive force.
- Samsung shall not be held liable for any product damage or personal injury caused by using a wall-mount kit other than the one specified or from an attempt to install the wall-mount kit on your own.
- To mount the product on a wall, ensure you purchase a wall-mount kit that can be installed 10 cm or farther away from the wall.
- Be sure to use a wall-mount kit that complies with the standards.

- To install the monitor using a wall mount, disconnect the stand base from the monitor.

Unit: mm

Model name	VESA screw hole specs (A * B) in millimeters	Standard Screw	Quantity
S22F350FH*/S22F352FH*/ S22F354FH*/S24F350FH*/ S24F352FH*/S24F354FH*/ S24F356FH*/S24F359FH*/ S27F350FH*/S27F352FH*/ S27F354FH*/S27F358FW*/ S27F359FH*	75.0 x 75.0	M4	4

- Do not install your Wall Mount Kit while your product is turned on. It may result in personal injury due to electric shock.

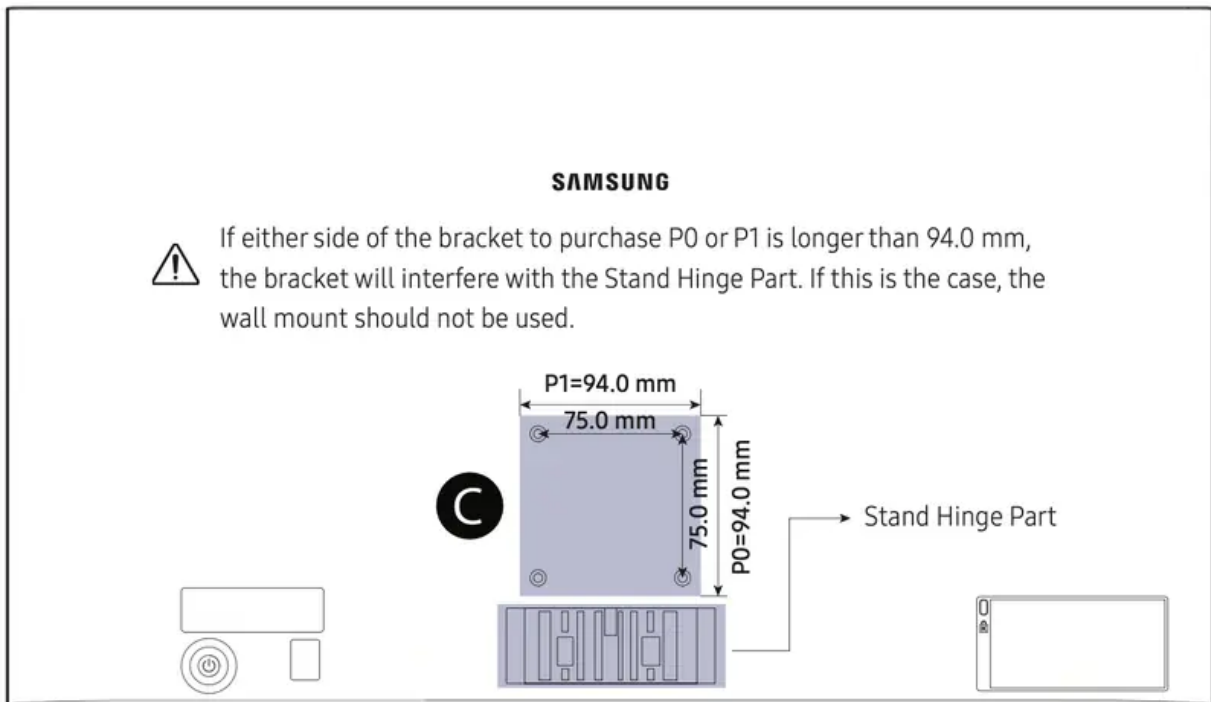

Refer to the area **C** in the image

- The dimensions of this model required by VESA are 75.0 x 75.0 mm. Please purchase the wall-mount tailored to the dimensions of 75.0 x 75.0 mm, and its external dimension required by VESA shall be less than 94.0 mm.
- Some wall mounts available in the market that have a 100.0 x 100.0 mm or 75.0 x 75.0 mm mounting hole pattern may not be compatible.

# Connecting and Using a Source Device

## Pre-connection Checkpoints

- Before connecting a source device, read the user manual provided with it.  
The number and locations of ports on source devices may differ from device to device.
- Do not connect the power cable before connecting all other cables.  
Ensure you connect a source device first before connecting the power cable. Connecting the power cable during connection may damage the product.
- Check the types of ports at the back of the product you want to connect.

## Connecting and Using a PC

Select a connection method suitable for your PC.

- Connecting parts may differ in different products.
- Provided ports may vary depending on the product.

### Connection Using the D-SUB Cable (Analog Type)

S22F350FH\*/S22F352FH\*/S22F354FH\*/S24F350FH\*/S24F352FH\*/  
S24F354FH\*/S24F359FH\*/S27F350FH\*/S27F352FH\*/S27F354FH\*/S27F359FH\*

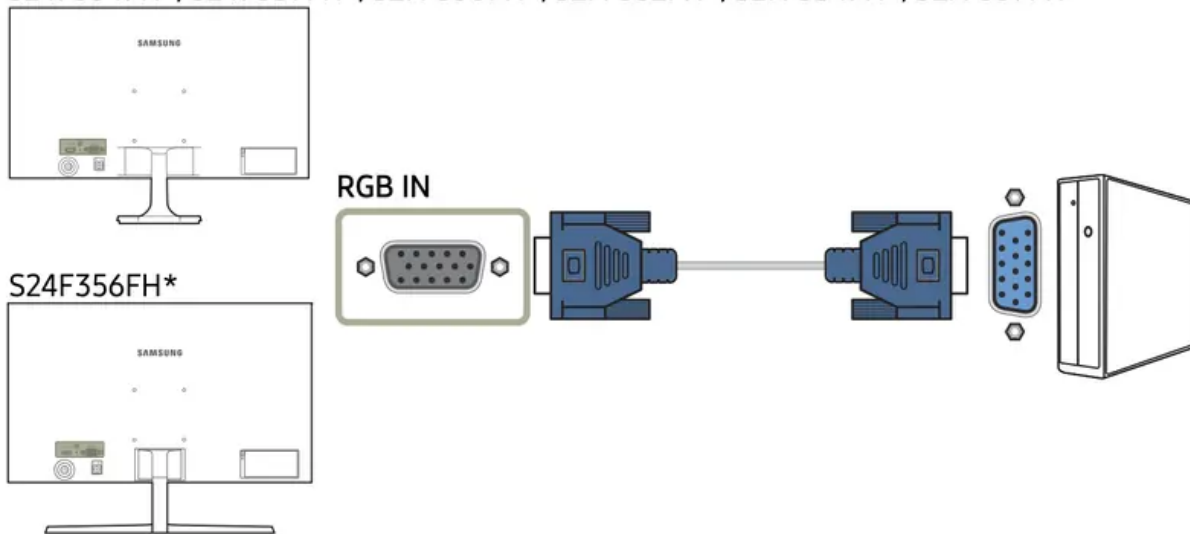

### Connection Using the HDMI or HDMI-DVI Cable

S22F350FH\*/S22F352FH\*/S22F354FH\*/S24F350FH\*/S24F352FH\*/  
S24F354FH\*/S24F359FH\*/S27F350FH\*/S27F352FH\*/S27F354FH\*/S27F359FH\*

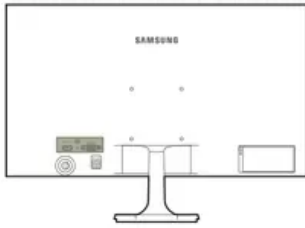

S24F356FH\*

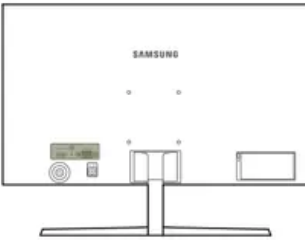

HDMI IN

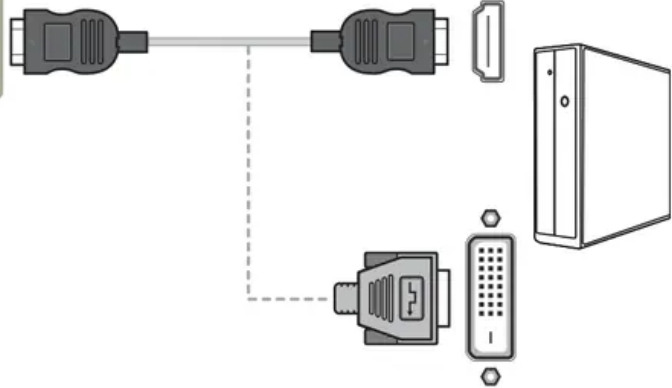

S27F358FW\*



S32F351FU\*



HDMI IN 1, HDMI IN 2

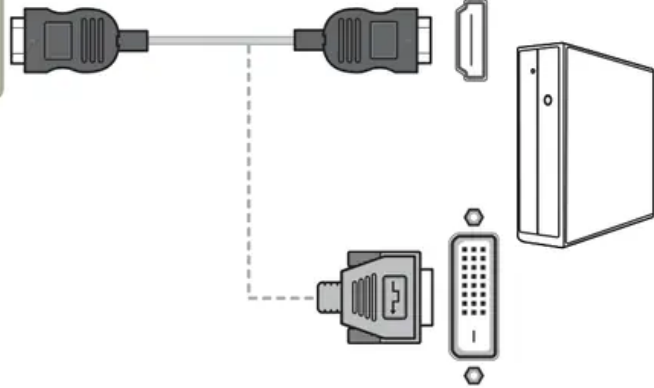
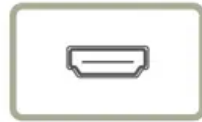

## Connecting the Power

Optional

S22F350FH\*/S22F352FH\*/S22F354FH\*/S24F350FH\*/S24F352FH\*/  
S24F354FH\*/S24F359FH\*/S27F350FH\*/S27F352FH\*/S27F354FH\*/S27F359FH\*

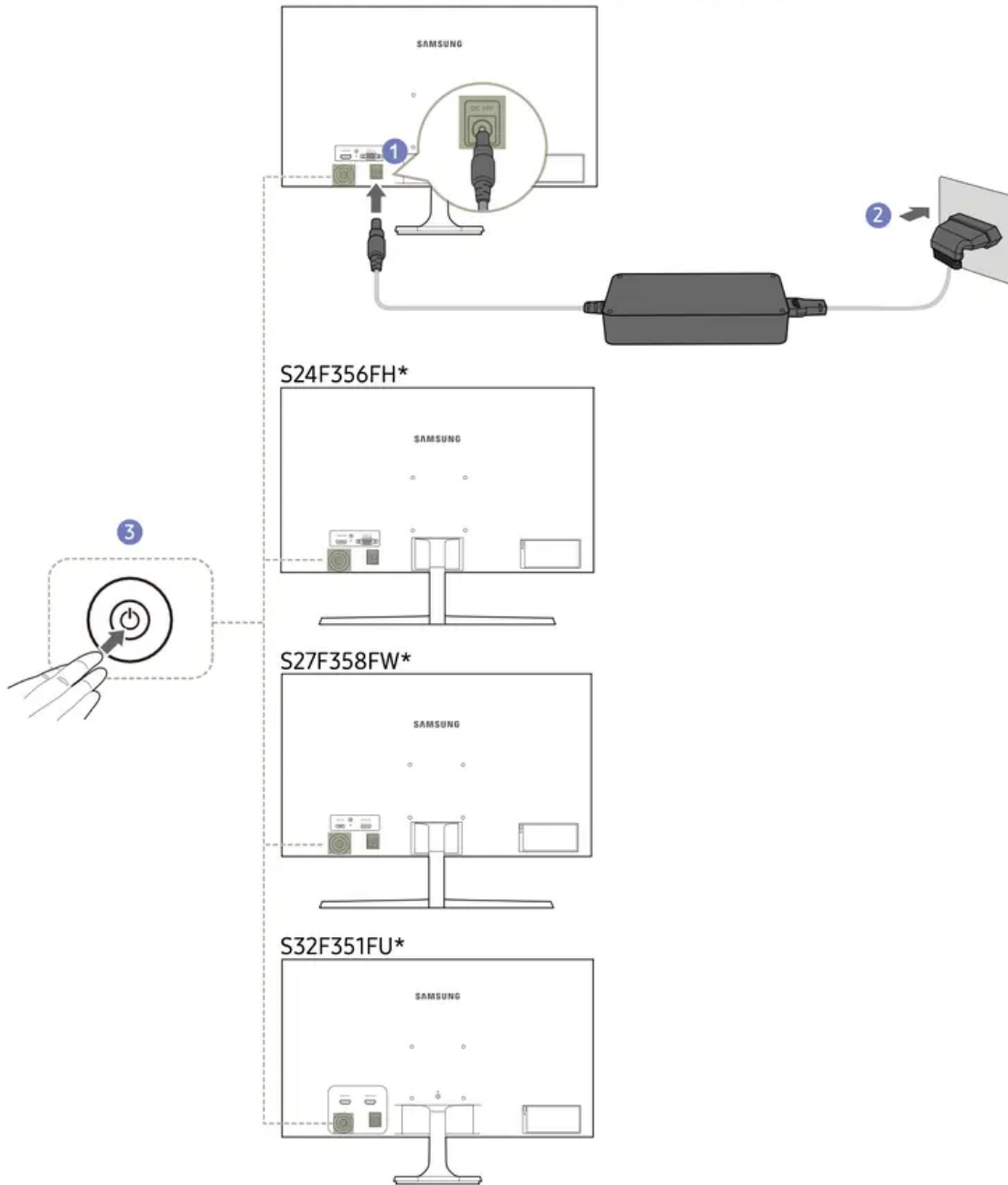

1. Connect the power cable to the AC/DC adapter. Then, connect the AC/DC adapter to the DC 14V port on the back of the product.
2. Next, connect the power cable to the power outlet.
3. Press the JOG button on the back of the monitor to turn it on.  
The input voltage is switched automatically.

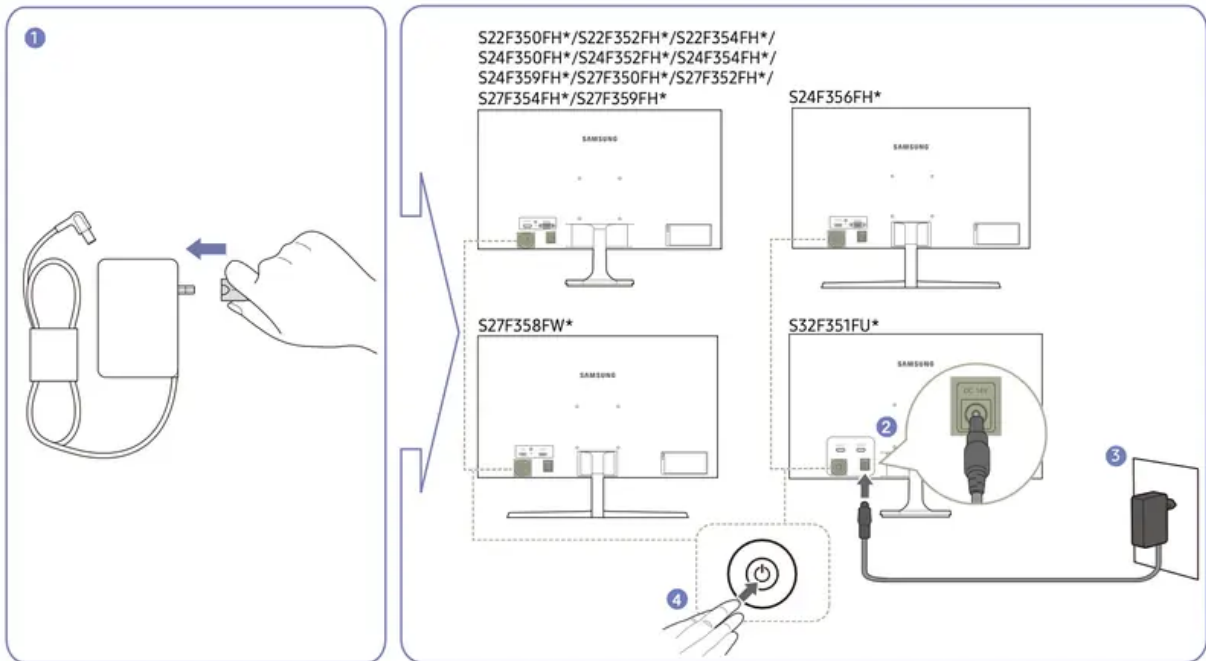

1. Connect the power plug to the AC/DC adapter. (Optional)
2. Connect the AC/DC adapter cable to the DC 14V port on the back of the monitor.
3. Plug the AC/DC adapter into the power outlet.
4. Press the JOG button on the back of the monitor to turn it on.  
The input voltage is switched automatically.

### Correct posture to use the product



Use the product in the correct posture as follows:

- Straighten your back.
- Adjust the angle so light does not reflect on the screen.
- Keep your forearms perpendicular to your upper arms and level with the back of your hands.
- Keep your elbows at about a right angle.
- Adjust the height of the product so you can keep your knees bent at 90 degrees or more, your heels attached to the floor, and your arms lower than your heart.

## **Driver Installation**

- You can set the optimum resolution and frequency for this product by installing the corresponding drivers.

## **Setting Optimum Resolution**

An information message about setting optimum resolution will appear if you power on the product for the first time after purchase.

Select a language on the product and change the resolution on your PC to the optimum setting.

- If the optimum resolution is not selected, the message will appear up to three times for a specified time even when the product is turned off and on again.
- The optimum resolution can also be selected in Control Panel on your PC.

# **Troubleshooting Guide**

## **Requirements Before Contacting Samsung Customer Service Center**

- Before calling Samsung Customer Service Center, test your product as follows. If the problem persists, contact Samsung Customer Service Center.

## **Testing the Product**

Check if your product is operating normally by using the product test function.

If the screen is turned off and the power indicator blinks even though the product is properly connected to a PC, perform a self-diagnosis test.

1. Power off both the PC and product.
2. Disconnect the cables from the product.
3. Power on the product.
4. If the message Check Signal Cable appears, the product is working normally.  
If the screen remains blank, check the PC system, video controller and cable.

## Checking the Resolution and Frequency

For a mode that exceeds the supported resolution(refer to Standard Signal Mode Table), the message Not Optimum Mode will appear for a short time.

- The displayed resolution may vary, depending on the computer system settings and cables.

**Check the following.**

### *Installation issue (PC mode)*

- **The screen keeps switching on and off.**
  - Check the cable connection between the product and PC, and ensure the connectors are locked.
- **Blank spaces are found on all four sides of the screen when an HDMI or HDMI-DVI cable is connected to the product and PC.**
  - The blank spaces found on the screen have nothing to do with the product.
  - Blank spaces on the screen are caused by the PC or graphics card. To resolve the problem, adjust the screen size in the HDMI or DVI settings for the graphics card.
  - If the graphics card settings menu does not have an option to adjust the screen size, update the graphics card driver to the latest version.
  - (Please contact the graphics card or computer manufacturer for further details about how to adjust the screen settings.)

### *Screen issue*

- **The power LED is off. The screen will not switch on.**
  - Check that the power cable is connected properly.
- **The message Check Signal Cable appears.**
  - Check that the cable is properly connected to the product.
  - Check that the device connected to the product is powered on.
- **Not Optimum Mode is displayed.**
  - This message appears when the signal from the graphics card exceeds the maximum resolution or frequency for the product.
  - Change the maximum resolution and frequency to suit the product performance, referring to Standard Signal Mode Table (P.42).
- **The images on the screen look distorted.**
  - Check the cable connection to the product.

- **The screen is not clear. The screen is blurry.**
  - Adjust Coarse and Fine.
  - Remove any accessories (video extension cable, etc.) and try again.
  - Set the resolution and frequency to the recommended level.
- **The screen appears unstable and shaky. There are shadows or ghost images left on the screen.**
  - Check that the resolution and frequency for the PC are within the range of resolution and frequency compatible with the product. Next, if required, change the settings, referring to Standard Signal Mode Table (P.42) in this manual and the Information menu on the product.
- **The screen is too bright. The screen is too dark.**
  - Adjust Brightness and Contrast.
- **Screen color is inconsistent.**
  - Change the Color settings.
- **The colors on the screen have a shadow and are distorted.**
  - Change the Color settings.
- **White does not really look white.**
  - Change the Color settings.
- **There is no image on the screen and the power LED blinks every 0.5 to 1 second.**
  - The product is operating in power-saving mode.
  - Press any key on the keyboard or move the mouse to return to normal operating mode.
- **Text is blurry.**
  - If using a Windows OS (e.g. Windows 7, Windows 8, Windows 8.1 or Windows 10): Go to Control Panel Fonts Adjust ClearType text and change Turn on ClearType.
- **Video playback is choppy.**
  - Playback of high-definition large video files can be choppy. This may be because the video player is not optimized for the computer resource.
  - Try playing the file on another video player.

#### **Source device issue**

- **A beeping sound is heard when my PC is booting.**
  - If a beeping sound is heard when your PC is booting, have your PC serviced.

The LED lights on the frame of the product may be seen depending on the user's viewing angle. The light is harmless to people and has no bearing on product features and performance. The product is safe to use.

## Q&A

- Refer to the user manual for your PC or graphics card for further instructions on adjustment.

### How can I change the frequency?

Set the frequency on your graphics card.

- Windows XP: Go to Control Panel > Appearance and Themes > Display > Settings > Advanced > Monitor, and adjust Refresh rate under Monitor settings.
- Windows ME/2000: Go to Control Panel > Display > Settings > Advanced > Monitor, and adjust Refresh rate under Monitor settings.
- Windows Vista: Go to Control Panel > Appearance and Personalization > Personalization > Display Settings > Advanced Settings > Monitor, and adjust Refresh rate under Monitor settings.
- Windows 7: Go to Control Panel > Appearance and Personalization > Display > Screen Resolution > Advanced settings > Monitor, and adjust Refresh rate under Monitor settings.
- Windows 8 (Windows 8.1): Go to Settings > Control Panel > Appearance and Personalization > Display > Screen Resolution > Advanced settings > Monitor, and adjust Refresh rate under Monitor settings.

### How can I change the resolution?

- Windows XP: Go to Control Panel > Appearance and Themes > Display > Settings, and adjust the resolution.
- Windows ME/2000: Go to Control Panel > Display > Settings, and adjust the resolution.
- Windows Vista: Go to Control Panel > Appearance and Personalization > Personalize > Display Settings, and adjust the resolution.
- Windows 8 (Windows 8.1): Go to Settings > Control Panel > Appearance and Personalization > Display > Adjust Resolution, and adjust the resolution.
- Windows 7: Go to Control Panel > Appearance and Personalization > Display > Adjust Resolution, and adjust the resolution.
- Windows 10: Go to Settings > System > Display > Advanced display settings, and adjust the resolution.

## How do I set power-saving mode?

- Windows XP: Set power-saving mode in Control Panel > Appearance and Themes > Display > Screen Saver Settings > Power options or BIOS SETUP on the PC.
- Windows ME/2000: Set power-saving mode in Control Panel > Display > Screen Saver Settings > Power options or BIOS SETUP on the PC.
- Windows Vista: Set power-saving mode in Control Panel > Appearance and Personalization > Personalize > Screen Saver Settings > Power options or BIOS SETUP on the PC.
- Windows 7: Set power-saving mode in Control Panel > Appearance and Personalization > Personalize > Screen Saver Settings > Power options or BIOS SETUP on the PC.
- Windows 8(Windows 8.1): Set power-saving mode in Settings > Control Panel > Appearance and Personalization > Personalize > Screen Saver Settings > Power options or BIOS SETUP on the PC.
- Windows 10: Set power-saving mode in Settings > Personalization > Lock screen > Screen timeout settings > Power & sleep or BIOS SETUP on the PC.

### Warning

This content is compiled from multiple sources and is provided for reference purposes only. It may not be complete or fully applicable to all situations. If you are unable to resolve your issue, please contact the product manufacturer or an authorized service provider for official support.