





Use & Care Guide for Range

COOKING RECOMMENDATIONS

Bakeware

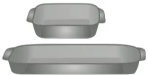
The material of bakeware affects how evenly and quickly it transfers heat from the pan to the food.

Material	Attributes	Recommendation
Shiny metal bakeware 	Shiny, aluminum, and non-coated bakeware is the best for even heating. It is suitable for all baked goods.	Recommended cooking temperatures and times are based on shiny metal bakeware.
Dark metal bakeware 	Dark bakeware cooks hotter than shiny bakeware.	Reduce the cooking temperature by 25° F (13-14° C) when using dark bakeware.
Glass bakeware 	Glass bakeware cooks hotter than shiny bakeware. Glass is convenient, as the same piece of bakeware can be used for cooking, serving, and storing food.	Reduce the cooking temperature by 25° F (13-14° C) when using glass bakeware.
Insulated bakeware 	Insulated bakeware cooks cooler than shiny bakeware. Insulated bakeware is designed for baking in gas ovens.	Increase the cooking temperature by 25° F (13-14° C) when using insulated bakeware.

Cooking Conditions

Conditions in your kitchen can affect the performance of your appliance when cooking food.

Condition	Attributes	Recommendation
Aging cookware	As pans age and become discolored, cooking times may need to be reduced slightly.	If food is too dark or overcooked, use the minimum cook time in the recipe or packaging. If food is too light or under cooked, use the middle to maximum cook time in the recipe or packaging.
High altitude	Air is drier and air pressure is lower.	Adjust cooking temperature, cooking time, or recipes as needed.
	Water boils at a lower temperature, and liquids evaporate faster.	Increase amount of liquid in baking recipes. Increase cook time on cooktop. Cover dishes to reduce evaporation.
	Foods may take longer to bake.	Increase bake time or oven temperature.
	Doughs may rise faster.	Reduce amount of baking soda or baking powder in recipe. Reduce rising time or punch down dough and allow it to rise twice.

Cooking Results

Small adjustments may fix a problem with food not being as done as you like or more done than you like.

Result	Recommendation
Food too light	Use the middle to maximum cook time recommended on packaging or recipe.
Food too dark	Use the minimum cook time recommended on packaging or recipe.

Cooking Tips

Use these additional tips to get the best results from your appliance.

Cooking	Tips
Baking	
Rack placement	<p>Follow the instructions in “SETTING OVEN CONTROLS” on starting on page 20.</p> <p>When using only one rack, place the rack so the food is in the center of the oven.</p>
Preheat	Fully preheat the oven before baking items like cookies, cakes, biscuits and breads. Insert food immediately after the beep.
Checking food	Use the window and oven light when checking food. Opening the door may reduce baking performance.
Bake or Convection Bake	Convection bake is the best function to use for baking on multiple racks. For best performance, see “Setting Quick Bake” on page 24.
Food placement	Allow at least 2 inches (5 cm) of space between bakeware for proper air circulation.
Broiling / Roasting	
Broiling pan	<p>For best results when broiling, use a broil pan with a broil pan insert designed to drain the fat from the food, help avoid spatter, and reduce smoking. The broiler pan will catch grease spills, and the insert helps prevent grease splatters.</p> <p>If a broiler pan and insert are not supplied with this appliance, they may be purchased from Frigidaire</p>
Convection Cooking	
Convection attributes	<p>Convection cooking uses a fan to circulate hot air around the oven and food. It browns food more evenly and reduces hot spots in the oven.</p> <p>Convection saves time when using multiple racks or cooking several food items at once.</p>

<p>Convection bake</p>	<p>Reduce cooking temperature by 25° F (13-14° C) from the recipe unless the recipe is written for convection baking.</p> <p>Preheat the oven for best results.</p>
<p>Convection roast</p>	<p>Convection roast is best for meats and does not require preheating for most meats and poultry.</p> <p>Reducing the cooking temperature for convection roast is not recommended. Carefully follow your recipe's temperature and time recommendations, adjusting the cooking time if the recipe does not specify convection roasting time.</p> <p>Since convection roast cooks faster, cook time may be reduced by 25% to 40% depending on food type. You can reduce cook times by 25% from the recommended time of your recipe, and check the food at this time. If needed, continue cooking until the desired doneness is obtained.</p> <p>Use a meat probe if available with your appliance. Meat probes are also available from most grocery and home goods stores.</p> <p>Arrange oven racks so large cuts of meat and poultry are on the lowest rack of the oven.</p> <p>Do not cover foods when dry roasting - covering will prevent the meat from browning properly.</p> <p>When cooking meats, use the broiler pan and insert or a roasting rack. The broiler pan will catch grease spills and the insert helps prevent grease splatters. If you do not have one of these accessories, they may be purchased from Frigidaire.</p>

BEFORE SETTING SURFACE CONTROLS

Assembly of the burner caps

Make sure that all of the surface burner caps and surface burner grates are installed correctly and at the correct locations.

1. Remove all packing material from the cooktop area.
2. Make sure burner caps are properly placed on the surface burners.
3. Unpack the burner grates and position them on the cooktop.
4. Discard all packing material.

On round-style burners, the burner cap lip (Figure 1) should fit snug into the center of the burner head and rest level. Refer to Figure 2 for correct and incorrect burner cap placement.



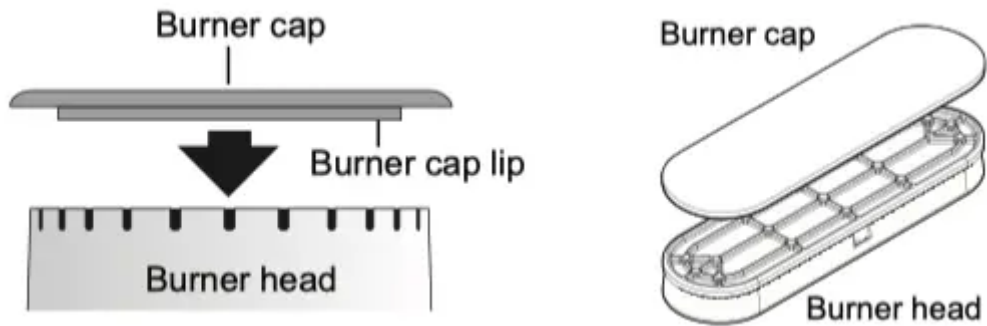

Figure 1: Burner caps and burner heads

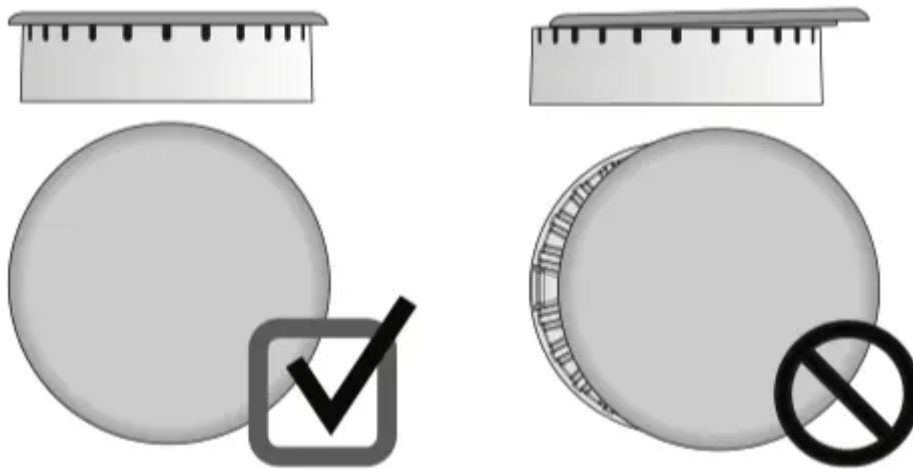

Figure 2: Proper burner cap placement

CAUTION

- Do not allow spills, food, cleaning agents, or any other material to enter the gas orifice holder opening.
- Always keep the burner caps and burner heads in place whenever the surface burners are in use.
- Never place flammable items on the cooktop.

Once in place, you may check the fit by gently sliding the burner cap from side to side (Figure 3) to be sure it is centered and firmly seated. When the burner cap lip makes contact inside the center of the burner head you will be able to hear the burner cap click.

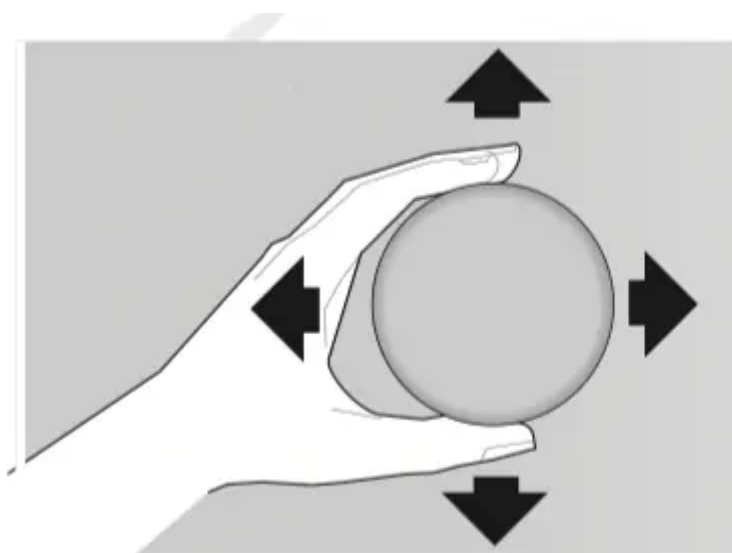

Figure 3: Gently move cap for proper placement

IMPORTANT

Please note that the burner cap should not move off the center of the burner head when sliding from side to side.

- Check and be sure that all oval-style burner caps (some models) are correctly in place on oval burner heads.
- Do not use the surface burners without the burner caps properly installed. Improperly seated burner caps may prevent burners from lighting or cause uneven flame and heating.
- Missing pieces or improper installation may lead to spills, burns, or damage to your range and cookware.
- Never place flammable items on the cooktop.

Install burner grates

To install burner grates, place the grates flat-side down and align them into the cooktop recess.

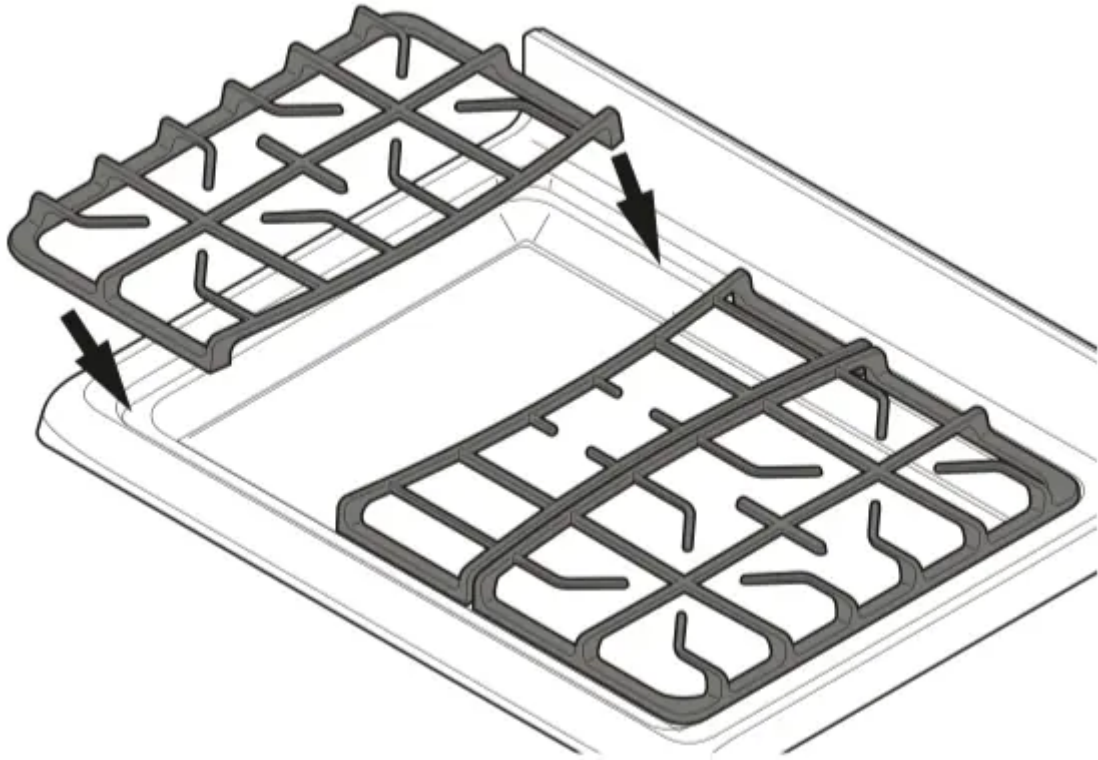

Figure 4: Proper grate installation

IMPORTANT

- Make sure the burner grates are properly placed on the cooktop before using the surface burners (Figure 4). The grates are designed to rest inside the recess on the cooktop.
- Grates should rest flush against each other and against the sides of the recess.
- Do not line the area underneath the grates or any part of the cooktop with aluminum foil or with any other lining.

Using Proper Cookware



Figure 5: Testing cookware

The size and type of cookware used will influence the heat setting needed for best cooking results. Be sure to follow the recommendations for using proper cookware as illustrated in Figure 5 and Figure 6.

Check for flatness by rotating a ruler across the bottom of the cookware (See Figure 5). Cookware should have flat bottoms that make good contact with the entire surface heating element (See Figure 6).

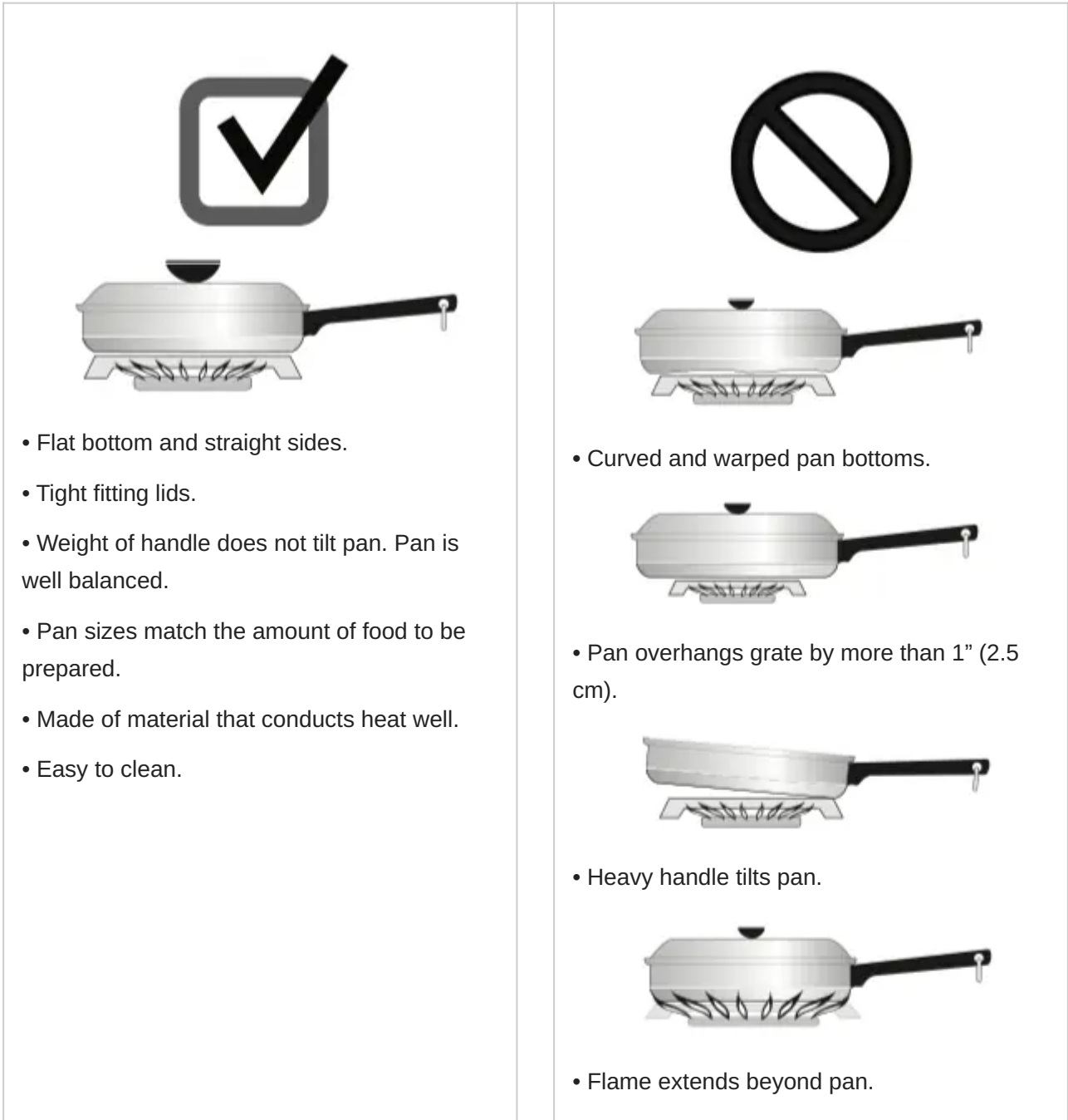

Figure 6: Proper cookware

Cookware Material Types

The cookware material determines how evenly and quickly heat is transferred from the surface burner to the pan bottom. The most popular materials available are:

- Aluminum - Excellent heat conductor. Some types of food will cause it to darken (Anodized aluminum cookware resists staining and pitting).
- Copper - Excellent heat conductor but discolors easily (See Aluminum).
- Stainless - Slow heat conductor with uneven cooking results. Is durable, easy to clean and resists staining.
- Cast Iron - A slow heat conductor that retains heat very well. Cooks evenly once cooking temperature is reached.
- Porcelain-enamel on metal - Heating characteristics will vary depending on base material.
- Glass - Slow heat conductor.

CAUTION

Do not place flammable items such as plastic salt and pepper shakers, spoon holders, or plastic wrappings on the cooktop when it is in use. These items could melt or ignite. Potholders, towels or wooden spoons could catch fire if placed too close to the range cooktop.

IMPORTANT

Do not place aluminum foil, or ANY material that can melt on the range cooktop. If these items melt they may damage the cooktop.

CAUTION

Do not straddle cookware over two burner areas unless the cookware is specifically designed for that purpose.

Gas surface burner types

The cooktop is equipped with gas surface burners with different BTU ratings. The ability to heat food quickly and in large amounts increases as the burner size increases.

- Small burners are best used for low-flame heating of small amounts of food.
- Standard burners can be used for most surface cooking needs.
- The largest burner is best used for bringing large quantities of liquid rapidly up to temperature or when preparing larger quantities of food. The large burner is located at the right front position on the cooktop.

Regardless of size, always select cookware that is suitable for the amount and type of food being prepared. Select a burner and set the flame size appropriately for the pan. Never allow flames to extend beyond the outer edge of the pan.

SETTING SURFACE CONTROLS

Setting surface controls

The ability to heat food quickly and in large volumes increases as the burner size increases. Your gas appliance may be equipped with many different sized surface burners.

It is important to select cookware that is suitable for the amount and type of food being prepared. Select a burner and flame size appropriate for the cookware size.

- The standard size burner or burners may be used for most surface cooking needs.
- Small burners are best used for low-flame heating of small amounts of food.
- Large burners are best for bringing large quantities of liquid to temperature or heating larger quantities of food.

Setting a surface burner:

1. Place cooking utensil on center of surface burner grate. Be sure the cooking utensil rests stable on the burner grate.
2. Push the burner's surface control knob in and turn counterclockwise out of the OFF position (Figure 7).
3. Release the surface control knob and rotate to the LITE position (). Visually check that the burner has a steady gas flame.
4. Once the surface burner has a flame, push the surface control knob in and turn counterclockwise to the desired flame size setting. Adjust the flame as needed using the knob markings.

IMPORTANT

- NEVER place or straddle a cooking utensil over two different surface cooking areas at the same time unless the cookware is specifically designed for the purpose.
- DO NOT cook with a surface control knob left in the lite position (). The electronic ignitor will continue to spark. Turn the control knob out of the lite position and adjust the flame size.
- Do not place aluminum foil, or ANY material that can melt on the range cooktop. If items melt, they may permanently damage the appearance of the cooktop.

CAUTION

Do not place flammable items such as plastic wrappings, spoon holders, or plastic salt and pepper shakers on the cooktop when it is in use. These items could melt or ignite. Potholders, towels, or wooden spoons could catch fire if placed too close to the surface burners.

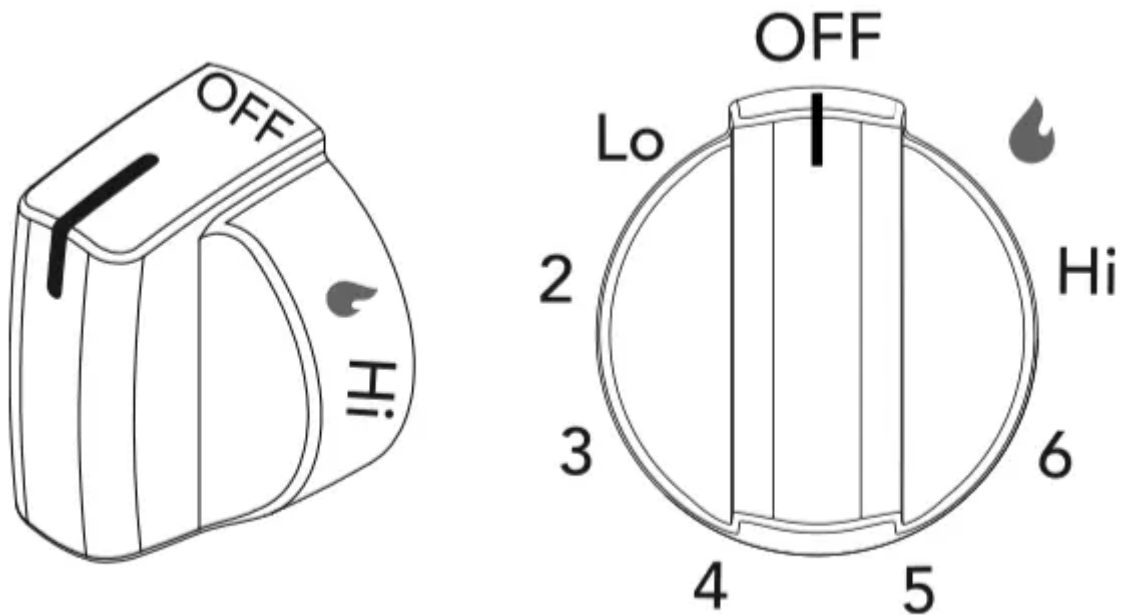

Figure 7: Surface control knob

NOTE

- When setting a surface control knob to the lite position, all of the electronic surface ignitors will spark at the same time. However, only the surface burner you are setting will ignite.
- In the event of an electrical power outage, the surface burners may be lit manually. To light a surface burner, hold a lit match to the burner head, then slowly turn the surface control knob to lite. Once the burner ignites, push in and turn knob out of lite then to the desired flame setting. Use caution when lighting surface burners manually.

Set proper burner flame size

The color of the flame is the key to proper burner adjustment. A good flame is clear, blue and hardly visible in a well-lighted room. Each cone of flame should be steady and sharp. Adjust or clean the burner if flame is yellow-orange.

For most cooking: start on the highest setting and then turn to a lower setting to complete the process. Use the recommendations below as a guide for determining proper flame size for various types of cooking (Figure 9).

For deep fat frying: use a thermometer and adjust the surface knob accordingly. If the fat is too cool, the food will absorb the fat and be greasy. If the fat is too hot, the food will brown so quickly that the center will be under-cooked. Do not attempt to deep fat fry too much food at once as the food will neither brown nor cook properly.

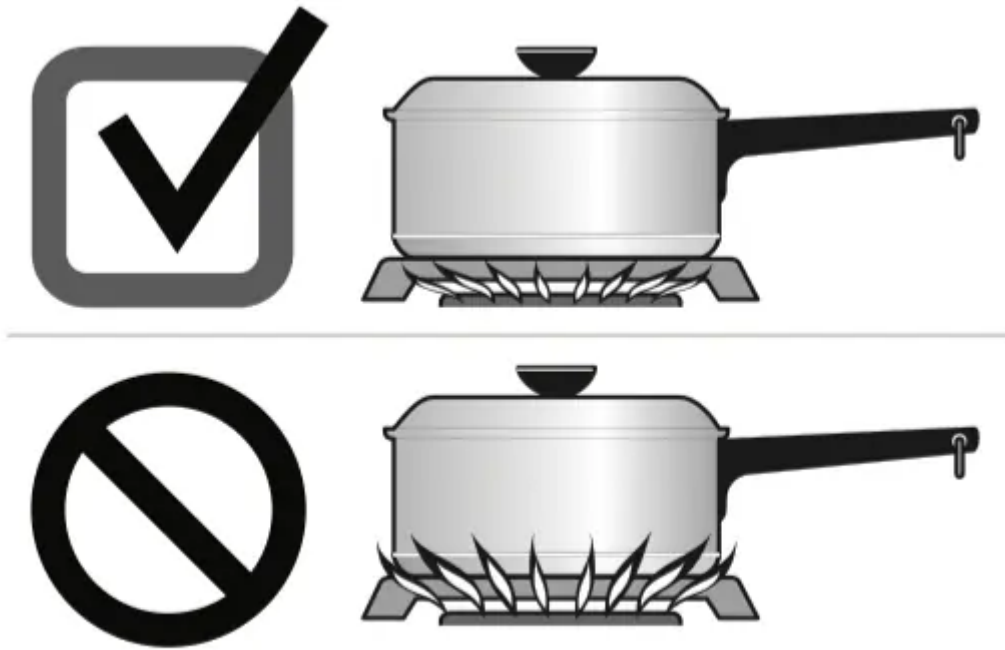

Figure 8: Flame settings

Flame size	Type of cooking
High flame	Start most foods; bring water to a boil; pan broiling
Medium flame	Maintain a slow boil; thicken sauces, gravies; steaming
Low flame	Keep foods cooking; poaching; stewing
<p>These settings are based on medium-weight metal or aluminum pans with lids. Settings may vary when using other types of pans.</p>	

CAUTION

Never extend the flame beyond the outer edge of the cooking utensil. A higher flame wastes energy, and increases your risk of being burned by the flame (Figure 8).

Cooking with a griddle (some models)



Figure 10: Griddle

The griddle is a versatile accessory that is perfect for cooking foods that require large flat surfaces such as pancakes, French toast, grilled sandwiches, bacon, and also for cooking different foods at the same time.

After use, let the griddle cool before washing. Hand wash with hot soapy water. Do not soak. Dry thoroughly. Do not put a griddle in a dishwasher.

If you would like to purchase a griddle, you can order one from Frigidaire.com.

Using the griddle:

Place the griddle securely on top of the burner grates. Preheat the griddle for 5 minutes on medium to medium low setting. Slow preheat ensures even heat distribution during the cooking process. DO NOT preheat the griddle on HI setting. Preheating on HI may warp the griddle and prevent even heat distribution.

Home Canning

Be sure to read and observe all the following points when home canning with your appliance. Check with the USDA (United States Department of Agriculture) Web site and be sure to read all the information they have available as well as follow their recommendations for home canning procedures.

- Use only a completely flat bottom canner with no ridges that radiate from the bottom center when home canning. Heat is spread more evenly when the bottom surface is flat. Use a straight-edge to check canner bottom.

- Make sure the diameter of the canner does not exceed 1 inch beyond the surface element markings or burner.
- It is recommended to use smaller diameter canners on electric coil and ceramic glass cooktops and to center canners on the burner grates.
- Start with hot tap water to bring water to boil more quickly.
- Use the highest heat setting when first bringing the water to a boil. Once boiling is achieved, reduce heat to lowest possible setting to maintain that boil.
- Use tested recipes and follow instructions carefully. Check with your local Cooperative Agricultural Extension Service or a manufacturer of glass jars for the latest canning information.
- It is best to can small amounts and light loads.
- Do not leave water bath or pressure canners on high heat for an extended amount of time.

BEFORE SETTING OVEN CONTROLS

Oven Vent Location

The oven is vented as shown below. When the oven is on, warm air is released through the vent. This venting is necessary for proper air circulation in the oven and good baking results. Do not block oven vent. Never close off the openings with aluminium foil or any other material. Steam or moisture may appear near the oven vent. This is normal.

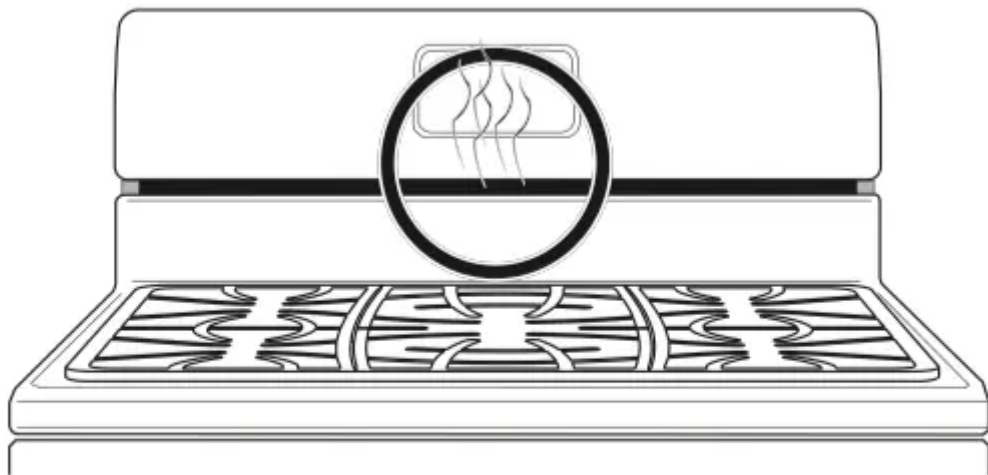

Figure 11: Oven vent

WARNING

Protective Liners — Do not use aluminum foil or any other material or liners to line the oven bottom, walls, racks or any other part of the range. Doing so will alter the heat distribution, produce

poor baking results, and possibly cause permanent damage to the oven interior. Improper installation of these liners may result in risk of electric shock or fire. During self clean, temperatures in the oven will be hot enough to melt foil.

CAUTION

- Always use pot holders or oven mitts when using the oven. When cooking, the oven interior, oven exterior, oven racks, and cooktop will become very hot which can cause burns.
- Remove all oven racks before starting a self clean cycle. If oven racks are left inside the oven during a cleaning cycle, the slide ability of the oven racks may be damaged and all of the oven racks will lose their shiny finish.
- To prevent possible damage to the oven, do not attempt to close the oven door until all the oven racks are fully positioned back inside the oven cavity.

Types of oven racks

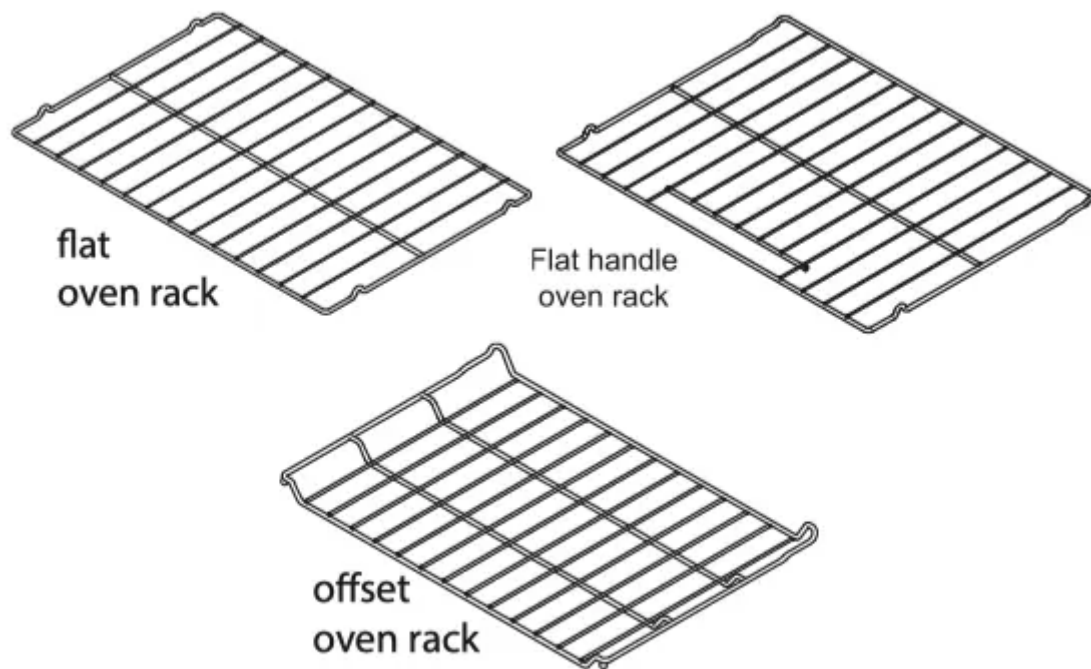

Figure 12: Oven rack types

- Flat oven racks may be used for most cooking needs and may be placed in most oven rack positions.
- The offset oven rack (some models) provides additional step down positions from the standard flat rack design. The offset design positions the base of the rack about $\frac{1}{2}$ of a rack position lower than the flat rack and may be used in most oven rack positions. To maximize oven cooking space, place the bottom oven rack in the lowest rack position for baking or roasting large cuts of meat.

Removing, replacing, and arranging flat or offset oven racks

Always arrange the oven racks when the oven is cool.

To remove - Pull the oven rack straight forward until it reaches the stop position. Lift up front of oven rack slightly and slide out.

To replace - Place the oven rack on the rack guides on both sides of oven walls. Tilt the front of oven rack upward slightly and slide the oven rack back into place. Be sure oven racks are level before using.

SETTING OVEN CONTROLS

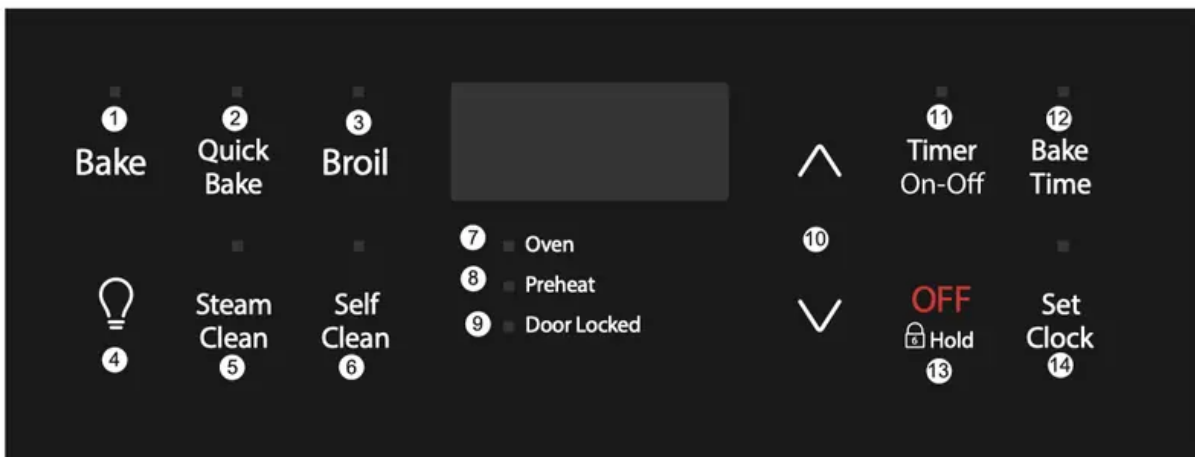

Oven Control Features

1. Bake - Use to select Bake feature.
2. Quick Bake - Quick Bake uses a fan to circulate the oven's heat uniformly and continuously around the oven. Use this feature for roasting foods too.
3. Broil - Use to set Broil feature.
4. Oven Light - Use to turn on internal light when checking on food. Light will turn on when the oven door is open.
5. Steam Clean - The Steam Clean feature offers a time saving method for cleaning light soils.
6. Self Clean - Use to with arrow keys to set self clean cycle of 2 or 3 hours.
7. Oven on indicator light - The oven light will glow each time the oven turns on to maintain the set oven temperature.
8. Preheat light - The preheat light will glow when the oven is preheating or if the desired temperature is reset higher than the actual oven temperature.

9. Door locked - The door locked light will flash when the oven door locks and unlocks, when the oven door lockout is active, or when the self clean cycle feature is active.

10. Up and Down arrows - Use with the feature or function keys to set oven temperature, Bake Time, Start Time, clean time, and setting or adjusting the clock and minute timer.

11. Timer on-off - Use to set or cancel the minute timer. The minute timer does not start or stop any cooking function. Timer on-off is used to set the continuous bake function.

12. Bake Time - Enters the length of baking time desired.

13. OFF - Use to clear any feature except the time of day and minute timer and to activate oven lockout feature.

14. Set Clock - Use with arrow keys to set the time of day.

Table 1: Minimum and Maximum Temp/Times

Feature	Mode	Min Temp/Time	Max Temp/Time
Bake		170°F (77°C)	550°F (288°C)
Quick Bake		300°F (148°C)	550°F (288°C)
Broil		LO 400°F (205°C)	HI 550°F (288°C)
Timer	12 Hr.	0:01 Min.	11:59 Hr./Min.
	24 Hr.	0:01 Min	11:59 Hr./Min.
Clock Time	12 Hr.	1:00 Hr./Min.	12:59 Hr./Min.
	24 Hr.	0:00 Min	23:59 Hr./Min.
Bake Time	12 Hr.	0:01 Min	5:59 Hr./Min.
	24 Hr.	0:01 Min	5:59 Hr./Min.
Self Clean Time		2 hours	3 hours

Note: An entry acceptance tone (1beep) will sound each time a key is touched (the oven lock key is delayed 3 seconds). An entry error tone (3 short beeps) will sound if the entry of the temperature or time is below the minimum or above the maximum settings for the feature.





Setting the Clock

When the appliance is first plugged in or when the power supply to the appliance has been interrupted, the display will flash 12:00. It is recommended to always set the clock for the correct time of day before using the appliance.

To set the clock:

1. Press Set Clock once (do not hold clock key down).

2. Within 5 seconds, press and hold  or  the correct time of day appears in the display.

NOTE

The clock cannot be changed when the oven is set for cooking or self clean is active.

Temperature display (Fahrenheit/Celsius)



The electronic oven control is set to operate in Fahrenheit (°F) at the factory. The oven may be programmed for any temperature from 170°F to 550°F (77°C to 288°C).

To change the temperature to Celsius (°C) or from °C to °F:

1. Press Broil. — — appears in the display.

2. Press and hold  until HI appears in the display.

3. Press and hold Broil until °F or °C appears in the display.

4. Press  or  to change °F to °C or °C to °F. To accept the change, wait 6 seconds.

Changing between continuous bake setting or 12hour energy saving feature

The oven control has a built-in 12-hour energy saving feature that will shut off the oven if the oven is left on for more than 12 hours. The oven control can be programmed to override this feature for continuous baking.

To change the continuous bake setting:

1. Press and hold Timer on-off for 6 seconds until a tone sounds. — — hr will appear in the display for continuous cooking. The current time of day will return to the display.

2. To cancel the continuous bake setting, press Timer on-off and hold for 6 seconds until a tone sounds. 12 hr will appear in display indicating that the control has returned to the 12-hour energy saving feature.

IMPORTANT

Changing to continuous bake or 12 hour mode does not change how the cooktop controls operate.

Setting oven lockout

The control can be programmed to lock the oven door and lockout the oven control keypad.

To set the oven lockout feature:

1. Press OFF and hold for 6 seconds. Loc will appear in display, the door locked indicator light will flash, and the motor driven door lock will begin to close. Allow about 15 seconds for the oven door to lock. Once the oven door is locked, the current time of day will appear in the display.
2. To cancel the Oven Lockout feature, press OFF and hold for 6 seconds. The control will unlock the oven door and resume normal operation.

NOTE

If any control key is pressed with the oven lockout feature active, Loc will appear in the display until the control key is released. But it does not disable the clock, kitchen timer, or the interior oven lights.



Operating oven light

The interior oven light will automatically turn on when the oven door is opened. Press the oven light key located on the control panel to turn the interior oven light on and off whenever the oven door is closed.



The interior oven light is located at the upper left rear wall of the oven interior. To change the interior oven light, see “Changing the oven light” in the Care & cleaning section.



Setting the minute timer

1. Press Timer on-off.
2. Press  to increase time in one-minute increments. Press and hold  to increase time in 10-minute increments. The timer can be set for any amount of time from 1 minute to 11 hours and 59 minutes.
3. When the set time ends, the timer will beep three times and will continue to beep three times every minute until Timer on-off is pressed.

NOTE

The minute timer will not start or stop the cooking process. The minute timer can be used alone or while using any of the other oven features. If another feature is active when the minute timer is active, the minute timer will show in the display. To view information about other active features, press the key for that feature.

To change the timer while it is in use:

While the timer is active and shows in the display, press and hold  or  to increase or decrease the time remaining.

To cancel the minute timer before the set time has run out:

- Press Timer on-off once.

Setting Bake

The oven can be programmed to bake at any temperature from 170°F to 550°F (77°C to 288°C). The factory preset automatic bake temperature is 350°F (177°C).

For best Bake results:

- Fully preheat the oven before baking items like cookies, cakes, biscuits and breads.
- When baking items like cookies, cakes, biscuits, and breads using a single rack place rack in position 4.
- When using any single rack for items like frozen pies, angel food cake, breads, and casseroles, use rack position 3.
- For best results when baking cakes using two oven racks, place racks in positions 3 and 5 (See Figure 14).
- When baking using two oven racks, position cookware as shown in Figure 13. Allow at least 2 inches (5 cm) of space between cookware for proper air circulation..

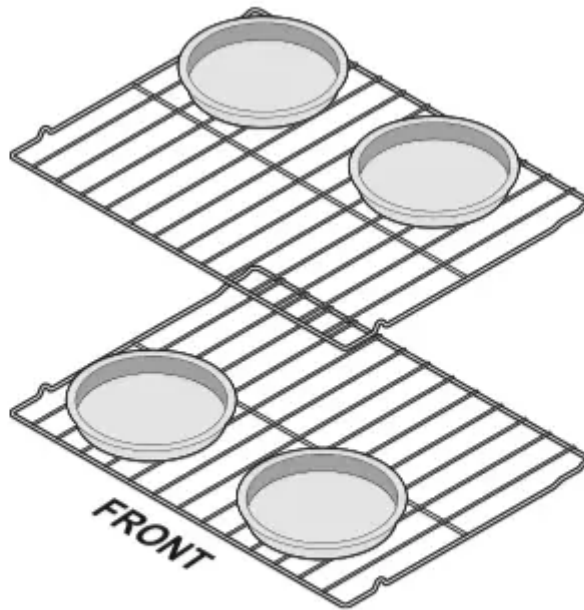



Figure 13: Pan positions two rack baking

To set Bake:

1. Press Bake. — — — appears in the display.



2. Within 5 seconds, press  or . The display will show 350°F (177°C). The temperature can then be adjusted in 5°F (1°C) increments.

3. When a key is released, the oven will begin heating to the selected temperature. When the oven reaches the set temperature, the preheat indicator light will turn off and the control will beep three times.

4. To cancel the baking function, press OFF.

To change oven temperature after Bake has started:

1. Press Bake.

2. Press  or  to increase or decrease to a new temperature. The oven indicator light on the electronic display will turn on and off when using the Bake feature and during preheat. This is normal and indicates that the oven is cycling to maintain the selected baking temperature. To cancel baking press OFF.

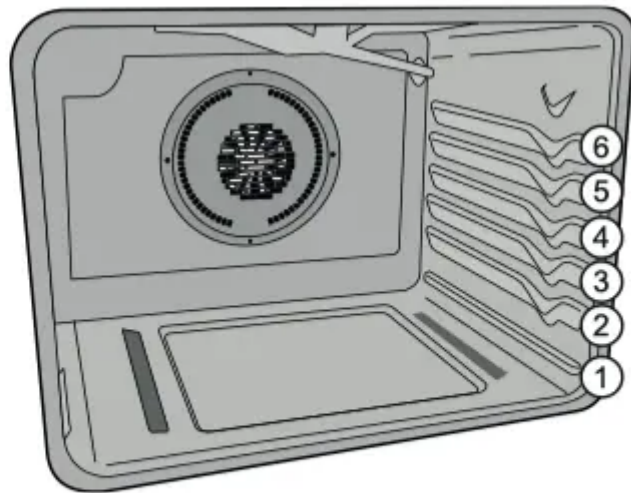

Figure 14: Rack positions for baking

Setting Quick Bake

Quick Bake uses a fan to circulate the oven's heat uniformly and continuously around the oven. The fan will turn on after 6 minutes once Quick Bake is set.

The oven may be programmed to Quick Bake at any temperature from 300°F to 550°F (148°C to 288°C). The factory preset Quick Bake temperature is 350°F (177°C).

Benefits of the Quick Bake feature:

- Foods may cook up to 25 to 30% faster, saving time and energy.
- Multiple rack baking.

Baking Tips

- Fully preheat the oven when baking foods such as cookies, biscuits and breads.
- Reduce oven temperature 25°F from recipe's recommended oven temperature. Follow the remainder of the recipe's instructions using the minimum recommended cook time.
- When using 2 oven racks place racks in positions 3 and 5 for and position cookware as shown in Figure 15.
- For single rack baking use rack position 4.

Roasting Tips

- Preheating is not necessary when roasting foods using Quick Bake. Do not cover foods when dry roasting.
- For Turkey, roasts and hams, use rack position 2.

- For small cuts of meat or poultry use rack positions 2 or 3.

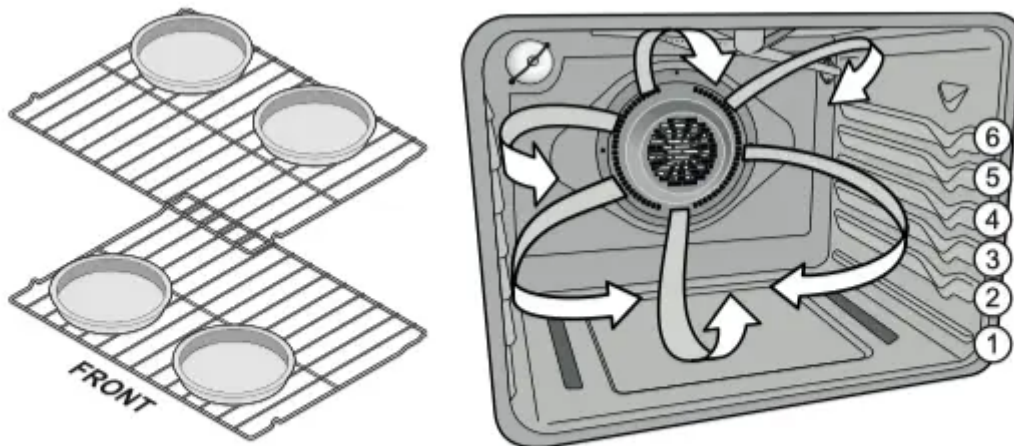





Figure 15: Pan spacing for two rack baking and oven rack positions

To set Quick Bake:

1. Press Quick Bake. — — — ° appears in the display.
2. Within 5 seconds, press  or . The display will show 350°F (177°C). The temperature can then be adjusted in 5°F (1°C) increments using the up or down arrow keys.
3. When a key is released, the oven will begin heating to the selected temperature.
4. When the oven reaches the set temperature, the preheat indicator light will turn off and the control will beep three times.
5. To cancel Quick Bake, press OFF.

To change oven temperature after bake has started:

1. Press Quick Bake.
2. Press  or  to increase or decrease to a new temperature. The oven indicator light on the electronic display will turn on and off when using the Bake feature and during preheat. This is normal and indicates that the oven is cycling to maintain the selected baking temperature.
3. To cancel baking press OFF.

Setting Broil

Broiling is direct heat cooking and will produce some smoke. If smoke is excessive, place food further away from the element. Watch food to prevent burning.





When broiling, always remember to arrange the oven racks while oven is still cool. Position the rack as suggested in Table 2.

CAUTION

Always use oven mitts. Oven racks will become very hot which can cause burns.

To set Broil

1. Arrange the oven rack while oven is still cool.
2. Press Broil. — — will appear in display.
3. Press  for HI broil or  for LO broil. Most foods may be broiled at the HI broil setting. Select the LO broil setting to avoid excess browning or drying of foods that should be cooked to the well-done stage.
4. For optimum results, preheat broil for 2-to-5 minutes before adding food.
5. If using a broil pan and insert, place insert on the broil pan. Place food on the insert
6. Place the broiler pan and insert on the oven rack. Broil with the oven door closed.
7. Broil on one side until food is browned. Turn and broil food on other side.
8. When broiling is finished press OFF.

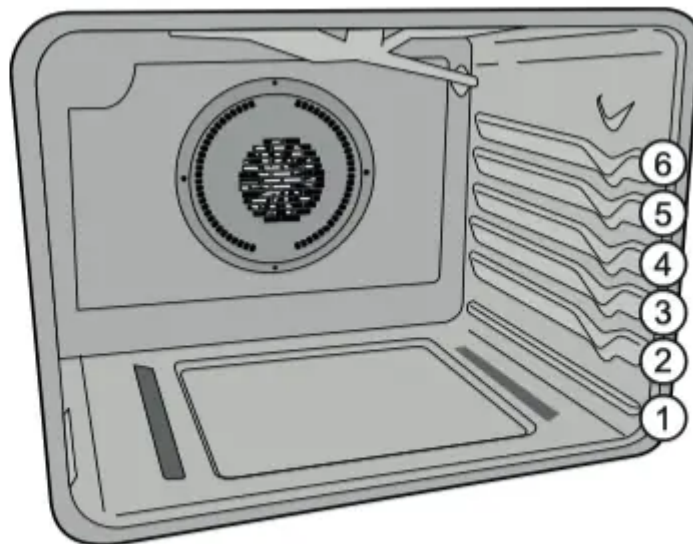

Figure 16: Rack positions

NOTE

Always pull the oven rack out to the stop position before turning or removing food.

WARNING

Should an oven fire occur, close the oven door and turn the oven off. If the fire continues, use a fire extinguisher. Do not put water or flour on the fire. Flour may be explosive.

NOTE

The broiler pan and the insert (some models) allow grease to drain and be kept away from the high heat of the broiler. Do not use the pan without the insert. Do not cover the insert with aluminum foil; the exposed grease could ignite.

To purchase a broiling pan and insert, visit frigidaire.com.



Figure 17: Broil pan and insert

Table 2: Broil recommendations

Food item	Rack Position	Temp	Cook time in minutes		Internal Temperature	Doneness
			1st side	2nd side		
Steak 1" thick	5	HI(550°F)	5:00	5:00	135°F (57°C)	Rare**
Steak 1" thick	5 or 6**	HI(550°F)	8:00	6:00	145°F (63°C)	Medium-well
Steak 1" thick	5 or 6**	HI(550°F)	10:00	8:00	170°F (77°C)	Well
Pork Chops 3/4 "thick	5	HI(550°F)	12:00	8:00	170°F (77°C)	Well
Chicken - Bone In	4	LO(400°F)	25:00	15:00	170°F (77°C)	Well
Chicken Boneless	5	LO(400°F)	10:00	8:00	170°F (77°C)	Well
Fish	5	HI(550°F)	as directed -		170°F (77°C)	Well
Shrimp	4	HI(550°F)	as directed --		170°F (77°C)	Well
Hamburger 1" thick	5	HI(550°F)	5:00	5:00	135°F (57°C)	Rare**
Hamburger 1" thick	6**	HI(550°F)	12:00	10:00	145°F (63°C)	Medium
Hamburger 1" thick	5	HI(550°F)	14:00	12:00	170°F (77°C)	Well

The U.S. Department of Agriculture states, "**Rare fresh beef is popular, but you should know that cooking it to only 140°F (60°C) means some food poisoning organisms may survive." (Source: Safe Food Book, Your Kitchen Guide, USDA Rev. June 1985.) The lowest temperature recommended by the USDA is 145°F (63°C) for medium rare fresh beef. For well done 170°F (77°C). All cook times shown are after 2 minutes of preheating.



** Use offset rack (if available) in position 6.

Setting Bake Time



The Bake Time key sets the amount of time needed for baking. The oven will turn on immediately and stop automatically after the set bake time ends.

To program the oven to begin baking immediately and to shut off automatically (timed bake):

1. Be sure the clock is set to the correct time of day.
2. Place the food in the oven.
3. Press Bake. — — — ° appears in the display.

4. Within 5 seconds, press  or . The display will show 350°F (177°C). The temperature can then be adjusted in 5°F (1°C) increments,

5. Press Bake Time. 0:00 will appear in the display.

6. Press  or  until the desired baking time appears in the display.

7. The oven will turn on and begin heating.

When the set bake time runs out:

1. End will appear in the display, and the oven will shut off automatically.
2. The control will beep three times every 60 seconds as a reminder until OFF is pressed.

NOTE

- Bake Time will not operate when using the broil feature.
- Once the controls are set, the oven will come on and begin heating to the selected baking temperature. The oven temperature (or time of day) will show in the display.

Adjusting the oven temperature

Your appliance has been factory calibrated and tested to ensure an accurate baking temperature. For the first few uses, follow your recipe times and temperature recommendations carefully. If you think the oven is cooking too hot or too cool for your recipe times, you can adjust the control so the oven cooks hotter or cooler than the temperature displayed.

NOTE

Do not use oven thermometers such as those found in grocery stores to check the temperature settings inside your oven. These oven thermometers may vary as much as 20 to 40 degrees from actual temperatures.

Oven temperature adjustments made will not affect the broil or self cleaning feature temperatures.

If the display is set for Celsius, adjustments made will be in 1°C increments with each press of arrow keys.

To adjust oven temperature:

1. Press Bake.

2. Set the temperature to 550°F (288°C) by pressing and holding .

3. Within 3 seconds, press and hold Bake until numeric digit(s) appear. Release Bake key. The display now indicates the amount of degrees offset between the original factory temperature setting and the current temperature setting. If the oven control has the original factory calibration, the display will read 00.

4. The temperature can now be adjusted up or down 35°F (19°C), in 5°F increments. Press

and hold  to adjust the temperature higher until the desired amount of offset appears

in the display. When lowering the oven temperature using , a minus sign (-) will appear before the number to indicate that the oven will be cooler by the displayed amount of degrees.

5. When you have made the desired adjustment, press OFF to go back to the time of day display.

Setting the Sabbath Feature for use on Jewish Sabbath and Holidays (some models)

This appliance provides special settings for use when observing the Jewish Sabbath/Holidays. Sabbath mode disables all audible tones or visual display changes on the oven control. Bake is the only cooking feature available while in the Sabbath mode. Oven controls are locked during Sabbath mode.

You must first set the Bake feature and temperature and, if needed, a Bake Time. Any settings made prior to setting the Sabbath mode will be visible in the displays. The Bake Time option, if set prior to the Sabbath mode, will give one audible alert at the end of Bake Time.

Important: The Sabbath mode will override the factory preset 6 hour energy saving mode, and the appliance will stay on until the cooking features are cancelled.

If any of the cooking features are cancelled when the appliance is in the Sabbath mode, no audible or visual indicators will be available to verify the cancellation.

If the oven interior lights are needed, be sure to activate them prior to setting the Sabbath mode. Once the oven light is turned on and the Sabbath mode is active, the oven light will remain on until the Sabbath mode is turned off and the oven lights are turned off. The oven door will not activate the interior oven lights when the oven door is opened or closed.

It is recommended that any oven temperature modification made within an active Sabbath mode press the up or down arrow key.

Note: The temperature will increase or decrease with each press by 5°F or 1°C and the change will be accepted automatically.

If the oven temperature is set outside of the temperature range, the oven will default to the nearest available temperature. Try to set the desired oven temperature again.

CAUTION

Food poisoning hazard. Do not let food sit for more than one hour before or after cooking. Doing so can result in food poisoning or sickness. Foods that can easily spoil such as milk, eggs, fish, meat or poultry, should be chilled in the refrigerator first. Even when chilled, they should not stand in the oven for more than 1 hour before cooking begins, and should be removed promptly when finished cooking.

Important:

- Do not attempt to activate any other oven function except Bake while the Sabbath feature is active. The following keys will function correctly when the Sabbath feature is active: Up

and Down arrow keys, Bake, and OFF. All other keys should not be used once the Sabbath feature is active.

- You may change the oven temperature once baking has started. Press Bake, use the arrow keys to raise or lower the oven temperature. Each press of an arrow key will raise or lower the temperature by 5°F (1°C).
- Remember that the oven control will no longer provide audible tones or display any further changes when the Sabbath feature is active.
- The oven will shut-off automatically after completing a Bake Time and may only be used once during the Sabbath/Jewish Holidays.

To program oven to Bake with default oven temperature of 350°F and activate the Sabbath feature:

1. Be sure the clock is set with correct time of day and place food in oven.
2. Press Bake. — — — appears in the display.

3. Within 5 seconds press  or . The display will show 350°F (177°C). By holding the up or down arrow key the temperature can be adjusted in 5° increments (1°C).

4. If a Bake Time is desired enter the time at this point. See “Setting Bake Time” on page 27 for detailed instructions. If not, skip this step.

NOTE: The oven will shut off after using Bake Time and may only be used once during Sabbath mode.

5. Press and hold the Bake Time key and Set Clock key simultaneously for about 3 seconds. SAb will appear in the display indicating the oven is properly set for the Sabbath feature (Figure 18).



Figure 18: Oven set for Sabbath baking

Once SAb appears in the display the oven control will no longer beep or display any further changes.

To turn the oven off and keep the Sabbath feature active:

1. Press OFF.

To turn off the Sabbath feature:

Press and hold both Bake Time key and Set Clock key simultaneously for at least 3 seconds to turn the Sabbath feature off. The control will provide an acceptance tone, and SAb will disappear from the display. The oven is no longer programmed for the Sabbath feature.

What to do during a power failure or power interruption after the Sabbath feature was activated:

Should you experience a power failure or interruption, the oven will shut-off. When power is restored the oven will not turn back on automatically. The oven will remember that it is set for the Sabbath, and the oven display will show the message SF for Sabbath failure (Figure 19).

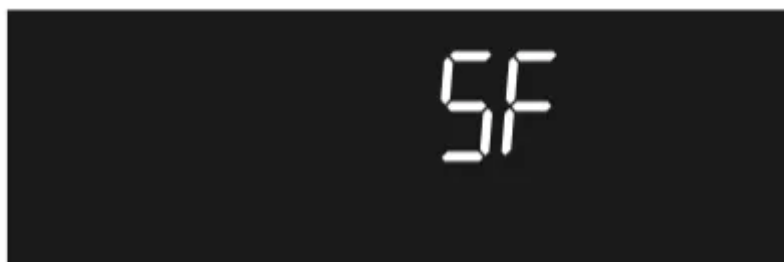

Figure 19: Display showing Sabbath failure

The food may be safely removed from the oven while still in the Sabbath feature, however the oven cannot be turned back on until after the Sabbath/Holidays. After the Sabbath observance turn off the Sabbath feature.

Press and hold both Bake Time key and Set Clock key for at least 3 seconds simultaneously to turn the Sabbath feature off. SF will disappear from the display, and the oven may be used with all normal functions.

Self Clean

A self cleaning oven cleans itself with temperatures well above normal cooking temperatures which eliminate soils completely or reduces them to a fine powdered ash you can wipe away with a damp cloth.

While the oven is in operation, the oven heats to temperature much higher than those used in normal cooking. Sounds of metal expansion and contraction are normal. Odor is also normal because the food soil is being removed. Smoke may appear through the oven vent.

CAUTION

During the self cleaning cycle, the outside of the range can become very hot to the touch. Do not leave small children unattended near the appliance.

To avoid possible burns, use care when opening the oven door after the self cleaning cycle. Stand to the side of the oven when opening the door to allow hot air or steam to escape.

Do not line the oven walls, racks, bottom, or any other part of the range with aluminum foil. Doing so will destroy heat distribution, produce poor baking results, and cause permanent damage to the oven interior (aluminum foil will melt to the interior surface of the oven).

The health of some birds is extremely sensitive to the fumes given off during the self cleaning cycle of any range. Move birds to another well-ventilated room.

Do not force the oven door open. This can damage the automatic door locking system. Use caution when opening the door after the self cleaning cycle is complete. The oven may still be very hot.



Figure 20: Clean around the oven door gasket

IMPORTANT



Adhere to the following self clean precautions:

- Do not use oven cleaners or oven protective coatings in or around any part of the oven interior.
- Do not clean the oven door gasket (Figure 20). The woven material of the oven door gasket is essential for a good seal. Care should be taken not to rub, damage, or remove the gasket.
- Do not use any cleaning materials on the oven door gasket. Doing so could cause damage.
- Remove the broiler pan and insert, all utensils, and any aluminum foil. These items cannot withstand high cleaning temperatures and will melt.
- Completely remove all oven racks and any accessories. If the oven racks are not removed, they will lose their special coating properties and no longer slide in and out of the oven cavity easily.
- Remove any excessive spills. Any spills on the oven bottom should be wiped-up and removed before starting the self cleaning cycle. To clean, use hot, soapy water and a cloth. Large spills can cause heavy smoke or fire when subjected to high temperatures.

- Do not allow food spills with a high sugar or acid content (such as milk, tomatoes, sauerkraut, fruit juices, or pie filling) to remain on the surface as they may leave a dull spot even after cleaning.
- Clean any soil from the oven frame, the door liner outside the oven door gasket, and the small area at the front center of the oven bottom. These areas heat sufficiently to burn soil on. Clean with soap and water. These areas are shown in white (Figure 20).

To set a self clean cycle

1. Press Self Clean. ----- will appear in the display

2. Press  until 3:00 appears in the display for a 3 hour self clean process, or push  until 2:00 appears in the display for a 2 hour self clean.

3. As soon as the controls are set, the motor driven lock will begin to close automatically and the door locked indicator light will flash. Do not open the oven door while the light is flashing (allow about 15 seconds for the oven door to lock).

4. CLn will appear in the display during the self clean cycle, and the door locked light will glow until the self cleaning cycle is complete or cancelled and the oven temperature has cooled.

When the self clean cycle has completed:

1. The time of day will appear in the display window and the door locked light will continue to glow.
2. Once the oven has cooled down for about 1 hour and the door locked light has gone out, the oven door may be opened.

CAUTION

Stand to the side of the oven when opening the door after a self clean. The oven may still be hot and could cause burns.

To stop or interrupt a self clean cycle (once it has been activated):

1. Press OFF.
2. Once the oven has cooled down for about 1 hour and the door locked light has turned off, the oven door can be opened.
3. Restart the self clean cycle once all conditions have been corrected.

NOTE

Whenever the self clean feature is active, you may check the amount of time remaining in the self clean cycle by pressing the self clean key.

Remember the range door cannot be opened until the range has cooled sufficiently. You will need to add about 1 hour to the time displayed before you can use the range for cooking.

When the oven is cool, wipe away any residue or powdered ash with a damp cloth or paper towel.

Steam Clean

The Steam Clean feature offers a chemical free and time saving method to assist in the routine cleaning of light soils. For heavier baked on soils use the Self Clean feature.

CAUTION

Do not add bleach, ammonia, oven cleaner, or any other abrasive household cleaners to the water used for Steam Clean.

Before cleaning any part of the oven, be sure all controls are turned off and the oven is cool. The oven may be hot and can cause burns.

Be sure the oven is level and cool before starting Steam Clean. If the oven temperature is above room temperature a triple beep will be heard and the function will not start. Steam Clean produces best results when started with a cool oven

To set a Steam Clean cycle:

1. Remove all racks and oven accessories.
2. Scrape or wipe loose debris and grease from the oven bottom.
3. Pour 1 cup of tap water onto the oven bottom.(Figure 21) Close oven door



Figure 21: Add 1 cup of tap water

4. Press steam clean.
5. Press either the up arrow or down arrow to activate. St Cn will appear in the display.
6. The time remaining in the Steam Clean cycle is shown in the display. Do not open the door during this time. If door is open while in steam clean (d-O) will appear in the display

7. When the steam clean cycle is complete an alert will sound and the END message will show in the display. Press OFF to return to the clock. Press OFF at any time to cancel Steam Clean.

8. Take care opening the door when the steam clean is finished. Stand to the side of the oven out of the way of escaping vapor.

9. Wipe oven cavity and bottom. Do not clean oven door gasket (Figure 22). Avoid leaning or resting on the oven door glass while cleaning cavity.

Note: To stop Steam Clean at any time press OFF.



Figure 22: Clean around the oven door gasket

Notes:

- Opening oven door during Steam Clean cycle prevents the water from reaching the temperature needed to clean.
- For best results, clean oven immediately after the cycle is complete. Steam clean works best for soils on the oven bottom.
- Place a paper towel or cloth in front of the oven to capture any water that may spill while wiping out.
- A non-abrasive scouring pad, stainless steel sponge, plastic scraper, or eraser style cleaning pad (without cleaner) can be used for difficult soils. Moisten pads with water before use.
- Do not leave the residual water in the oven for any length of time.
- Some condensation or water vapor may appear close to the oven vent or the oven door glass. This is normal. The oven gasket may become damp; do not wipe dry.
- Local water sources often contain minerals (hard water). If hard water deposits occur, wipe cavity with a 50/50 solution of water and vinegar or 50/50 solution of lemon juice and water.
- If steam clean results are not satisfactory, run a self clean. See “Self Clean” on page 30.

CARE AND CLEANING

Remove spills and any heavy soiling as soon as possible. Regular cleaning will reduce the difficulty of major cleaning later.

CAUTION

- Before cleaning any part of the appliance, be sure all controls are turned off and the appliance is cool.
- If ammonia or appliance cleaners are used, they must be removed and the appliance must be thoroughly rinsed before operating. Follow manufacturer's instructions and provide adequate ventilation.

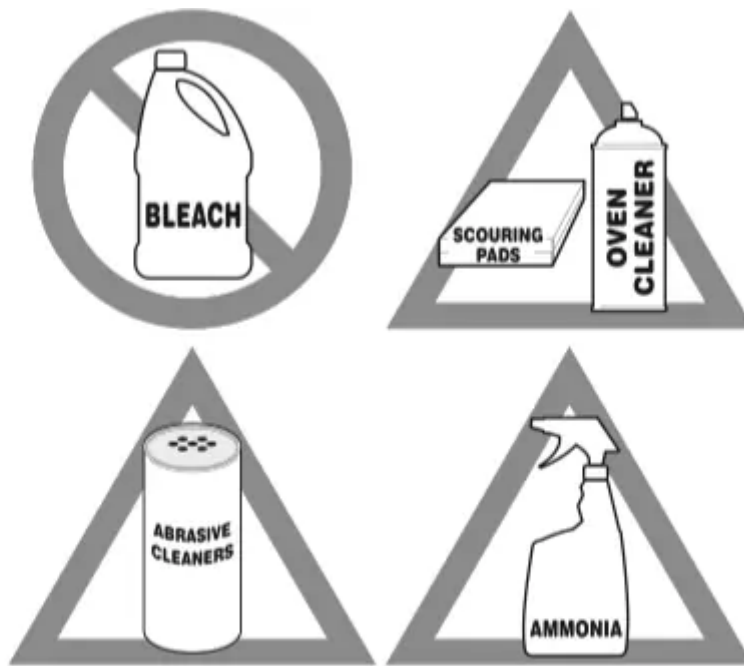

Figure 23: Use cleaners with caution

Surface or Area	Cleaning Recommendation
Aluminum and vinyl	Using a soft cloth, clean with mild dish detergent and water. Rinse with clean water, dry and polish with a soft, clean cloth.
Painted and plastic control knobs Painted body parts Painted decorative trims	Using a soft cloth, clean with mild dish detergent and water or a 50/50 solution of vinegar and water. Rinse with clean water, dry and polish with a soft, clean cloth. Glass cleaners may be used, but do not apply directly to surface; spray onto cloth and wipe.
Control panel	Using a soft cloth, clean with mild dish detergent and water or a 50/50 solution of vinegar and water. Do not spray liquids directly on the oven control and display area. Do not use large amounts of water on the control panel - excess water on the control area may cause damage to the appliance. Do not use other liquid cleaners, abrasive cleaners, scouring pads, or paper towels - they will damage the finish.
Control knobs	Using a soft cloth, clean with mild dish detergent and water or a 50/50 solution of vinegar and water. To remove control knobs: turn to the OFF position, grasp firmly, and pull off the shaft. To replace knobs after cleaning, line up the OFF markings and push the knobs into place.
Stainless Steel	Using a soft cloth, clean with mild dish detergent and water or a 50/50 solution of vinegar and water. Rinse with clean water, dry with a soft clean cloth. Do not use cleaners containing abrasives, chlorides, chlorine, or ammonia.
Smudge Proof™ Stainless Steel Black Stainless Steel	Using a soft cloth, clean with mild dish detergent and water or a 50/50 solution of vinegar and water. Rinse with clean water, dry with a soft clean cloth. Do not use appliance cleaner, stainless steel cleaner, or cleaner containing abrasives, chlorides, chlorine, or ammonia. These cleaners may damage the finish.
Porcelain-enameled	Rinse with clean water and a damp cloth. Scrub gently with a soapy, non-abrasive scouring pad to remove most spots. Rinse with a 50/50 solution of

<p>broiler pan and insert</p> <p>Porcelain door liner</p> <p>Porcelain body parts</p>	<p>clean water and ammonia. If necessary, cover difficult spots with an ammonia-soaked paper towel for 30 to 40 minutes. Rinse and wipe dry with a clean cloth. Remove all cleaners or future heating could damage the porcelain. Do not allow food spills with a high sugar or acid content (milk, tomatoes, sauerkraut, fruit juices or pie filling) to remain on porcelain surfaces. These spills may cause a dull spot even after cleaning.</p>
<p>Self-cleaning oven interior</p>	<p>Before setting a self-clean cycle, clean soils from the oven frame, areas outside the oven door gasket, and the small area at the front center of the oven bottom. See “Self Clean” on page 30.</p>
<p>Oven door</p>	<p>Use mild dish detergent and water or a 50/50 solution of vinegar and water to clean the top, sides, and front of the oven door. Rinse well. Glass cleaner may be used on the outside glass of the door. Ceramic smoothtop cleaner or polish may be used on the interior door glass. Do not immerse the door in water. Do not spray or allow water or cleaners to enter the door vents. Do not use oven cleaners, cleaning powders, or any harsh abrasive cleaning materials on the outside of the oven door.</p> <p>Do not clean the oven door gasket. The oven door gasket is made of a woven material which is essential for a good seal. Do not rub, damage, or remove this gasket.</p>
<p>Gas cooktop surface burners</p>	<p>See “Cleaning the sealed burners” on page 35.</p>
<p>Gas cooktop surface grates</p> <p>Gas cooktop burner caps</p>	<p>Use a non-abrasive plastic scrubbing pad and mild abrasive cleanser. Do not allow food spills with a high sugar or acid content (milk, tomatoes, sauerkraut, fruit juices or pie filling) to remain on the burner grates or burner caps. These spills may cause a dull spot even after cleaning. Clean these spills as soon as surfaces are cool. Thoroughly dry immediately following cleaning.</p>

Aluminum Foil and Utensils

WARNING

Never cover any slots, holes, or passages in the oven bottom or cover an entire oven rack with materials such as aluminum foil. Aluminum foil linings may trap heat, causing a fire hazard.

Protective Liners — Do not use aluminum foil to line the oven bottom. Improper installation of these liners may result in risk of electric shock or fire.

Cleaning the sealed burners

IMPORTANT

Aluminum foil - Use of aluminum foil on a hot cooktop can damage the cooktop. Do not use thin aluminum cooking utensils or allow aluminum foil to touch the surface elements under any circumstances.

Aluminum utensils - The melting point of aluminum is much lower than that of other metals. Care must be taken when aluminum pots or pans are used on the cooktop. If aluminum pans are allowed to boil dry when using the cooktop, not only will the utensil be damaged or destroyed, but it may fuse to, break, or mark the ceramic glass surface, permanently damaging the cooktop surface.

To avoid possible burns, do not attempt cleaning before turning off all surface burners and allowing them to cool.

Any additions, changes, or conversions required in order for this appliance to satisfactorily meet the application needs must be made by an authorized qualified Agency. Routinely clean the cooktop. Wipe with a clean, damp cloth and wipe dry to avoid scratches. Keeping the surface burner head ports and slots clean will prevent improper ignition and an uneven flame.

To clean recessed and contoured areas of cooktop:

- If a spill occurs on or in the recessed or contoured areas, blot up spill with an absorbent cloth.
- Rinse with a clean, damp cloth and wipe dry.

CAUTION

To avoid possible burns do not attempt to operate the surface burners without the burner caps.

Do not use spray oven cleaner on the cooktop.

To clean burner heads:

1. Remove the burner cap from the burner head (see Figure 24). Clean the cap with hot soapy water and dry thoroughly.

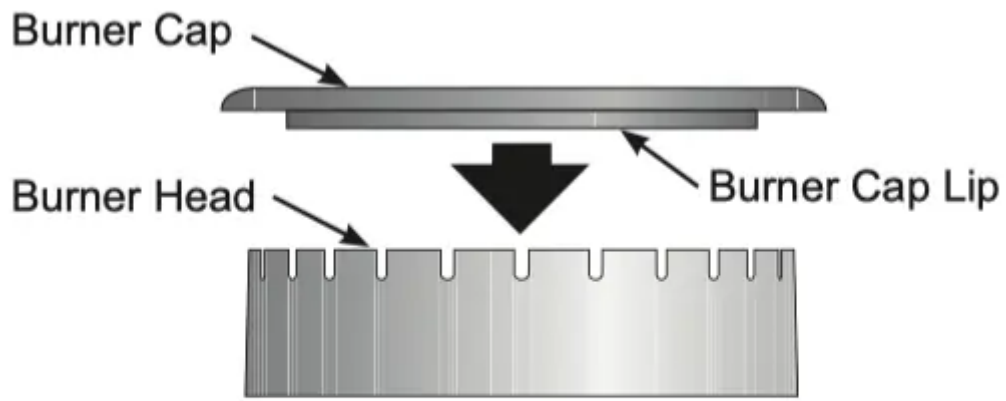

Figure 24: Burner Cap

2. For burned-on and dried spills, apply hot soapy water to the burner head. Allow time for the soils to soften.

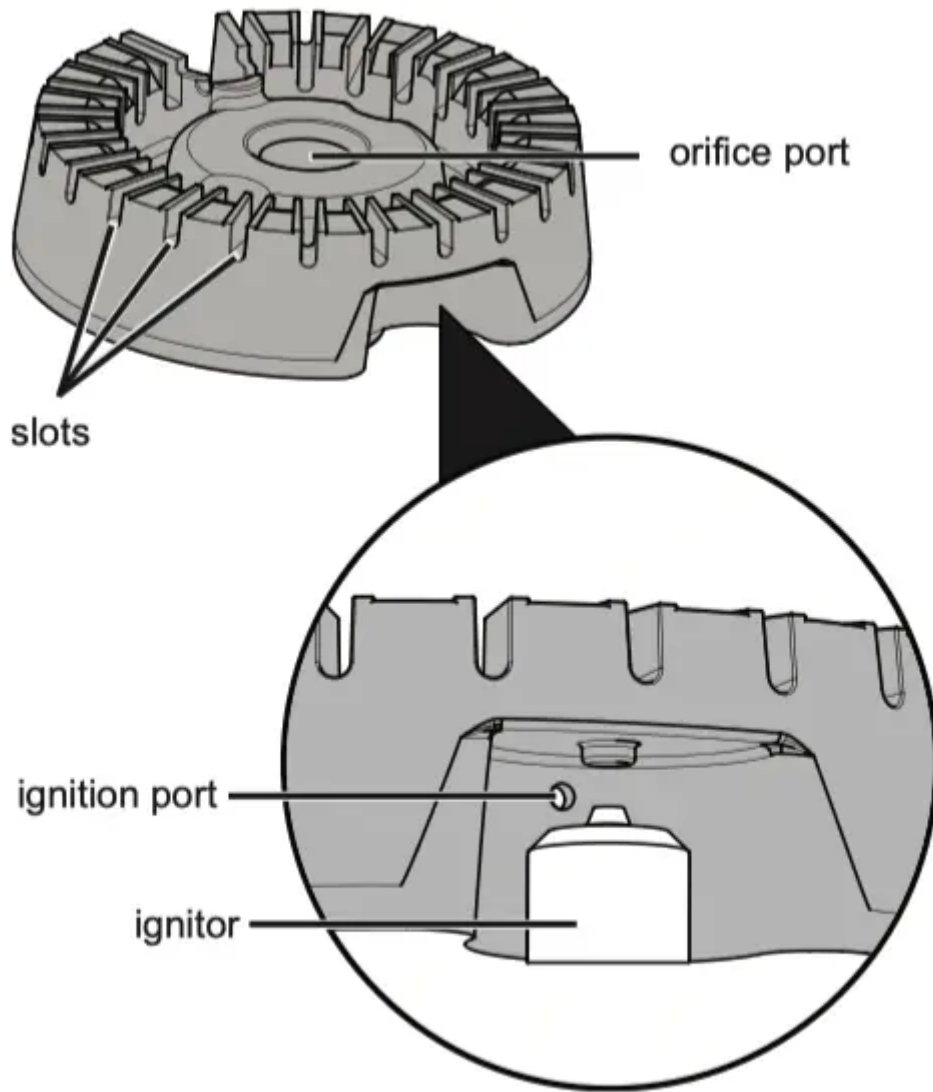

Figure 25: Sealed burner components

3. Use a toothbrush to clean all over the burner head (see Figure 25).
4. Use the toothbrush to clean the slots and holes in the burner (see Figure 25).
5. Use a needle or fine wire to clean out the ignition port (see Figure 25).
6. Wipe the burner head clean with a soft, clean cloth, sponge, or scratch-free cleaning pad.
7. Before using the cooktop again, make sure the burner caps are properly placed and seated on the burner heads. When placed correctly, the burner cap is centered on the burner head and will click into place on the burner head. You can wiggle the cap to test placement, it should not move off the burner head (see “Assembly of the burner caps” on page 13).

Important notes:

- The surface burner heads are secured to the cooktop and must be cleaned in place on the cooktop.

- Always keep the surface burner caps in place whenever a surface burner is in use.
- When replacing the burner caps, be sure the burner caps are seated firmly on top of the burner heads.
- For proper flow of gas and ignition of burners do not allow spills, food, cleaning agents, or any other material to enter the gas orifice port opening.

Replacing the Oven Light

CAUTION

Be sure the oven is unplugged and all parts are cool before replacing the oven light.

Replacing the oven interior light bulb:

The interior oven light is located at the rear of the oven cavity and covered with a glass shield. The glass shield must be in place whenever the oven is in use (Figure 26).

1. Turn electrical power off at the main source or unplug the appliance.
2. Remove the interior oven light shield after removing the wire holder by carefully moving the wire to the side of the glass shield. The tension from the wire holds the glass shield in place.
3. Pull the shield straight out. Do not twist or turn.
4. Replace the bulb with a new appliance bulb.
5. Replace the glass oven light shield. Replace wire holder.
6. Turn the power back on again at the main source (or plug the appliance back in).
7. Be sure to reset the time of day on the clock.

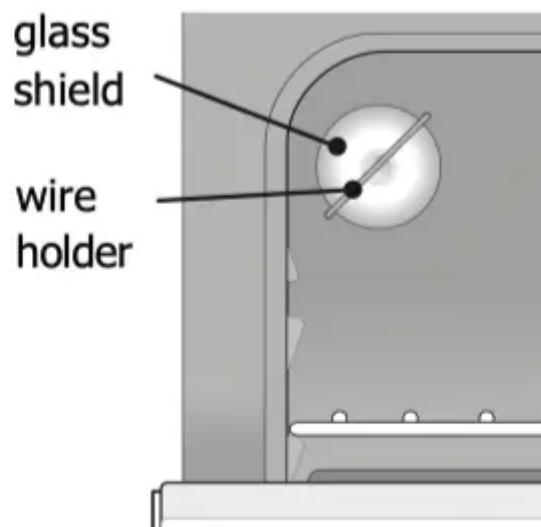

Figure 26: Oven light protected by glass shield

To remove and replace storage drawer (some models)

Use the storage drawer for storing cooking utensils. The drawer can be removed to facilitate cleaning under the range. Use care when handling the drawer.

To remove the drawer:

1. Pull empty drawer out until it stops.
2. Tilt up the front of the drawer up and pull it out over the glide stop.

To replace the drawer:

1. Insert the back of the drawer into the opening.
2. Lift up the drawer and line up the drawer supports with the rails. Make sure to clear the glide stop.
3. Push in the drawer until it stops.

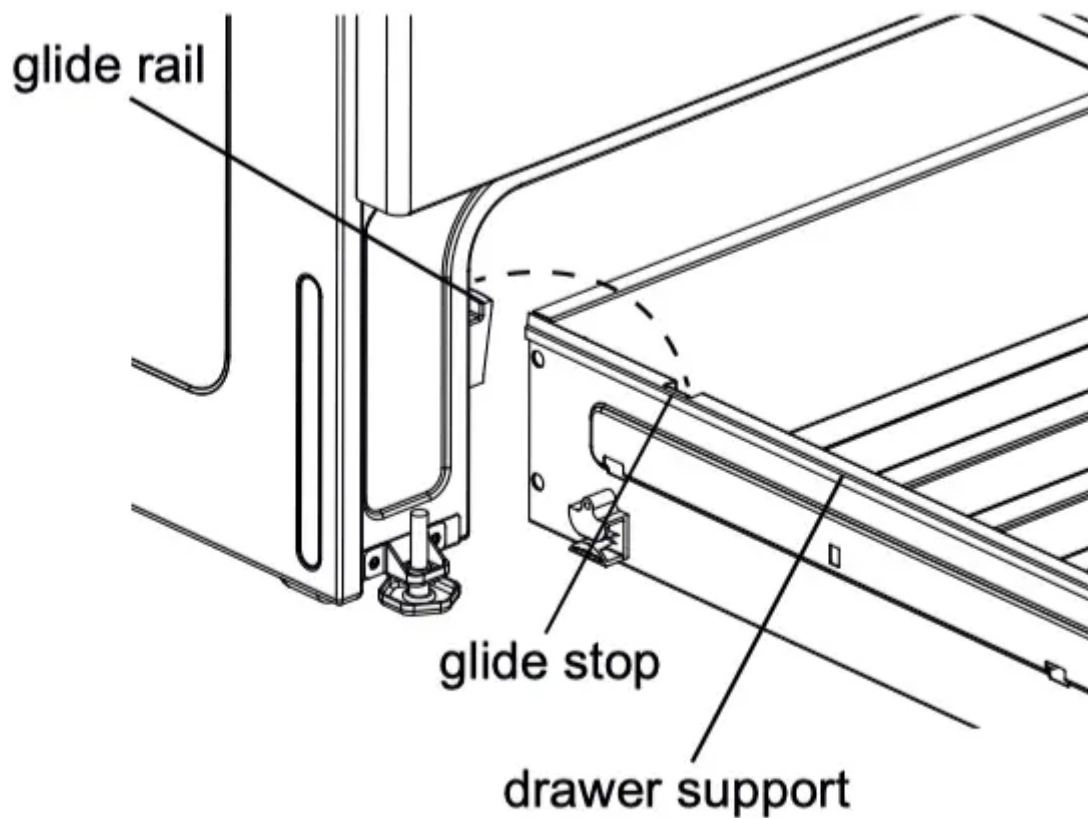

Figure 27: Parts of storage drawer

Removing and Replacing the Oven Door

To remove oven door:

CAUTION

The door is heavy. For safe, temporary storage, lay the door flat with the inside of the door facing down.

1. Open oven door completely, horizontal with floor (See Figure 28).

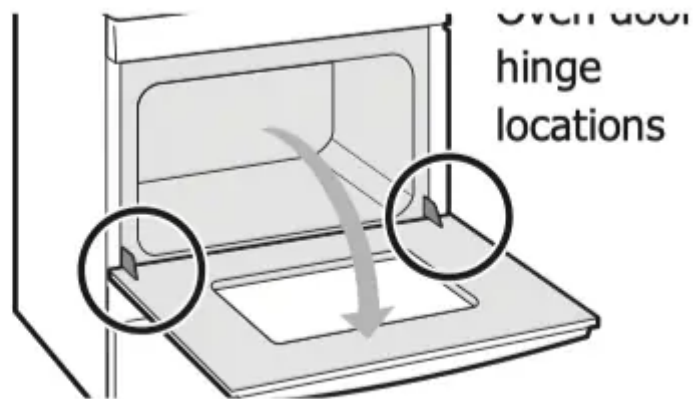

Figure 28: Door hinge location

2. Pull the door hinge locks on both left and right door hinges down from the oven frame completely towards the oven door (See Figure 29). A tool such as a small flat-blade screwdriver may be required.

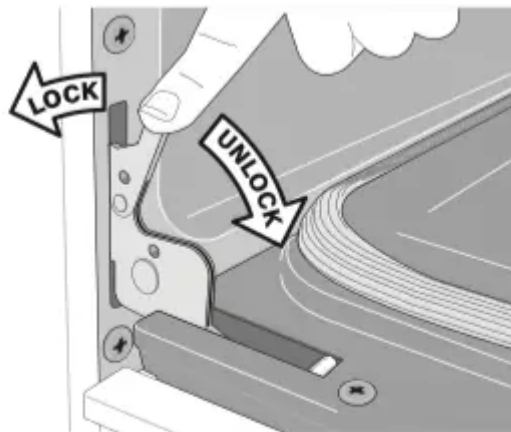

Figure 29: Door hinge locks

3. Firmly grasp both sides of oven door along the door sides. Do not use the oven door handle (See Figure 30).

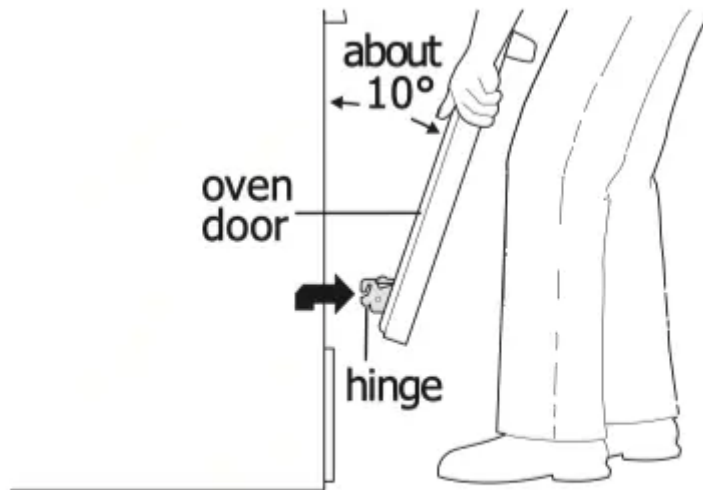

Figure 30: Holding door for removal

4. Close the door to approximately 10 degrees from the door frame (See Figure 30).
5. Lift the oven door hinge arms over the roller pins located on each side of the oven frame (See Figure 31).

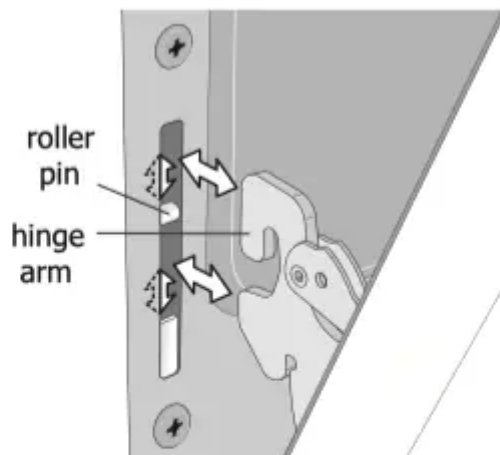

Figure 31: Replacement and location of hinge arm and roller pin

To replace oven door:

1. Firmly grasp both sides of oven door along the door sides. Do not use the oven door handle (See Figure 30).
2. Holding the oven door at the same angle as the removal position, seat the hook of the hinge arm over the roller pins located on each side of the oven door frame (See Figure 30 and Figure 31). The hook of the hinge arms must be fully seated onto the roller pins.
3. Fully open the oven door, horizontal with floor (See Figure 28).

4. Push the door hinge locks up towards and into the oven frame on both left and right oven door hinges to the locked position (See Figure 29).
5. Close the oven door.





IMPORTANT

Special door care instructions - Most oven doors contain glass that can break. Do not hit the glass with pots, pans, or any other object. Scratching, hitting, jarring, or stressing the glass may weaken its structure, causing an increased risk of breakage at a later time. Do not close the oven door until all of the oven racks are fully in place.

BEFORE YOU CALL

Oven Baking

For best cooking results, preheat the oven before baking cookies, breads, cakes, pies, pastries, etc. There is no need to preheat the oven for roasting meat or baking casseroles. The cooking times and temperatures needed to bake a product may vary slightly from your previously owned appliance.

Baking Problems	Causes	Corrections
<p>Cookies and biscuits burn on the bottom.</p> 	<ul style="list-style-type: none"> • Cookies and biscuits put into oven before oven is preheated. • Oven rack is overcrowded. • Dark pan absorbs heat too fast. 	<ul style="list-style-type: none"> • Allow oven to preheat to desired temperature before placing food in oven. • Choose pan sizes that will permit at least 2" of air space (5.1 cm) on all sides when placed in the oven. • Use a medium weight shiny baking sheet.
<p>Cakes too dark on top or bottom</p> 	<ul style="list-style-type: none"> • Cakes put in oven before oven is preheated. • Rack position too high or too low. • Oven too hot. 	<ul style="list-style-type: none"> • Allow oven to preheat to the selected temperature before placing food in the oven. • Use proper rack position for baking needs. • Set oven temperature 25°F (13°C) lower than recommended.
<p>Cakes not done in center</p> 	<ul style="list-style-type: none"> • Oven too hot. • Incorrect pan size. • Pan not centered in oven. • Glass cookware slow heat conductor. 	<ul style="list-style-type: none"> • Set oven temperature 25°F (13°C) lower than recommended. • Use pan size suggested in recipe. • Use proper rack position and place pan so there are at least 2" (5.1 cm) of space on all sides of pan. • Reduce temperature and increase cook time or use shiny bakeware.
<p>Cakes not level.</p> 	<ul style="list-style-type: none"> • Oven not level. • Pan too close to oven wall or rack overcrowded. • Pan warped. • Oven light left on while baking 	<ul style="list-style-type: none"> • Place a marked glass measuring cup filled with water on the center of the oven rack. If the water level is uneven, refer to the installation instructions for leveling the oven. • Use proper rack position and place pan so there are at least 2" (5.1 cm) of space on all sides of pan. • Do not use pans that are dented or warped. • Do not leave the oven light on while baking.

<p>Foods not done when cooking time is over.</p> 	<ul style="list-style-type: none"> • Oven too cool. • Oven overcrowded. • Oven door opened too frequently. 	<ul style="list-style-type: none"> • Set oven temperature 25°F (13°C) higher than suggested and bake for the recommended time. • Be sure to remove all pans from the oven except the ones to be used for baking. • Open oven door only after the shortest recommended baking time.
---	---	---

Solutions to Common Problems:

Before you call for service, review the following list. It may save you time and expense. Possible solutions are provided with the problem listed.



Problem	Cause / Solution
<p>Entire appliance does not operate.</p>	<p>Appliance not connected. Make sure power cord is plugged properly into outlet. Check your fuse box or breaker box to make sure the circuit is active.</p> <p>Electrical power outage. Check house lights to be sure. Call your local electric company for service outage information.</p>
<p>Oven Problems</p>	
<p>Poor baking results.</p>	<p>Many factors affect baking results. Use proper oven rack position. Center food in the oven and space pans to allow air to circulate. Preheat the oven to the set temperature before placing food in the oven. Try adjusting the recipe's recommended temperature or baking time. See "Adjusting the oven temperature" on page 27 if you feel the oven is too hot or too cool.</p>
<p>Flames inside oven or smoking from oven vent.</p>	<p>Excessive spills in oven. Grease or food spilled onto the oven bottom or oven cavity. Wipe up excessive spills before starting the oven. If flames or excessive smoke are present when using broil, see "Setting Broil" on page 25.</p>
<p>Oven smokes excessively when broiling.</p>	<p>Incorrect setting. Follow the "Setting Broil" instructions on page 25.</p> <p>Meat too close to the broil element or burner. Reposition the broil pan to provide proper clearance between the meat and broil element or burner. Remove excess fat from meat. Cut remaining fatty edges to prevent curling, but do not cut into lean.</p> <p>Grease build up on oven surfaces. Regular cleaning is necessary when broiling frequently. Grease or food splatters will cause excessive smoking.</p>
<p>Oven control panel beeps and displays any F or E code error.</p>	<p>Oven control has detected a fault or error condition. To clear the error, press the OFF key on the control panel. Once the error code is cleared, try the bake or broil function. If the F or E code error repeats, turn off the power to appliance, wait 5 minutes, and then repower the appliance. Set the clock with correct time of day. Try the bake or broil function again. If the fault recurs, press the OFF key to clear.</p>
<p>Oven portion of appliance does not operate.</p>	<p>Be sure the regulator gas valve is turned to ON. See installation instructions.</p> <p>The time of day is not set. The clock must be set in order to operate the oven. See "Setting the Clock" on page 21.</p>



	<p>Be sure the oven controls are set properly for the desired function. See “SETTING OVEN CONTROLS” and review instructions for the desired cooking function in this manual or see “Entire appliance does not operate.” in this checklist.</p>
<p>Convection fan does not rotate.</p>	<p>Oven door is open. The convection fan will turn off if the oven door is opened when convection is active. Close the oven door.</p> <p>On gas models, the convection fan will begin to rotate about 6 minutes into the preheating process.</p>
<p>Surface burners do not ignite.</p>	<p>Surface control knob was not completely turned to LITE (). Push in and turn the surface control knob to LITE until the burner ignites and then turn the control knob to the desired flame size.</p> <p>Burner ports are clogged. With the burner OFF and cool, use a small-gauge wire or needle to clean the burner head slots and ignition ports. See “Cleaning the sealed burners” in the Care & Cleaning section on page 35 for additional cleaning instructions.</p> <p>Range power cord is disconnected from outlet (electric ignition models only). Be sure the power cord is securely plugged into the power outlet.</p> <p>Circuit is broken. Check breaker box or fuse box.</p> <p>Electrical power outage. Burners may be lit manually. See “Setting surface controls” on page 16.</p>
<p>Surface burner flame uneven or only part way around burner cap.</p>	<p>Burner slots or ports are clogged. With the surface burner OFF and cool, clean ports with a small-gauge wire or needle. If moisture is present after cleaning, lightly fan the flame and allow the burner to operate until flame is full.</p> <p>Burner caps are not seated properly. Check that all burner caps are level and seated correctly on the burner heads. See “Cleaning the sealed burners” in the Care & Cleaning section on page 35 for additional cleaning instructions.</p>
<p>Surface burner flame is too high.</p>	<p>Surface control knob is set too high. Adjust to a lower flame setting.</p> <p>Burner caps are not seated properly. Check that all surface burner caps are level and seated correctly on the surface burner heads. See “Cleaning the sealed burners” in the Care & Cleaning section on page 35 for additional cleaning instructions.</p>



	Incorrect L.P. conversion. Refer to L.P. conversion kit instructions to correct.
Surface burner flame is orange.	Dust particles in main gas line. Allow the burner to operate a few minutes until flame turns blue. In coastal areas, a slightly orange flame is unavoidable due to salt content in the air. Incorrect L.P. conversion. Refer to L.P. conversion kit instructions to correct.
Self Clean Problems	
Self clean does not work.	Oven control not set properly. See "Self Clean" on page 30.
Oven racks discolored or do not slide easily.	Oven racks left in oven cavity during self clean. Remove oven racks from oven cavity before starting a self-clean cycle. Clean by using a mild abrasive cleaner following manufacturer's instructions. Rinse with clean water, dry, and replace in oven.
Soil not completely removed after self clean.	Self clean was interrupted. Review instructions on "Self Clean" on page 30. Excessive spills on oven bottom. Remove excessive spills before starting self clean. Failure to clean soil from the oven frame, the door liner outside the oven door gasket, and the small area at the front center of the oven bottom. These areas are not in the self-cleaning area, but get hot enough to burn on residue. Clean these areas before starting the self-cleaning cycle. Burned-on residue can be cleaned with a stiff nylon brush and water or a nylon scrubber. Be careful not to damage the oven gasket.
The oven control display shows "SPr" and self-clean is not working.	The cooktop should not be used during a self-clean cycle. On some models, turning on any cooktop surface burner will cause the clean cycle to cancel. If the clean cycle is canceled, the oven control display will show "SPr" for 5 seconds. The oven door will remain locked until the oven has cooled down below cleaning temperature. If the oven is below cleaning temperature, the user can start another clean cycle immediately. If the oven is in cleaning temperature range, another self-clean cycle can be set once the door unlocks (up to 4 hours).
Other Problems	
Appliance is not level.	Be sure the floor is level, strong, and stable enough to adequately support the range. If the floor is sagging or sloping, contact a carpenter to correct the situation.



	<p>Poor installation. Place the oven rack in the center of the oven. Place a level on the oven rack. Adjust the leveling legs at the base of the appliance until the rack is level.</p> <p>Kitchen cabinet alignment may make range appear not level. Be sure cabinets are square and have sufficient room for appliance clearance.</p>
<p>Cannot move appliance easily. Appliance must be accessible for service.</p>	<p>Cabinets not square or are built in too tightly. Contact the builder or installer to make the appliance accessible.</p> <p>Carpet interferes with appliance. Provide sufficient space so the appliance can be lifted over carpet. Installation over carpet is not advised. See the installation instructions for guidelines specific to your appliance.</p>
<p>Oven light does not work.</p>	<p>Be sure the oven light is secure in the socket. See “Replacing the Oven Light” on page 36.</p>

Warning

This content is compiled from multiple sources and is provided for reference purposes only. It may not be complete or fully applicable to all situations. If you are unable to resolve your issue, please contact the product manufacturer or an authorized service provider for official support.

