

PRODUCT DESCRIPTION

Parts

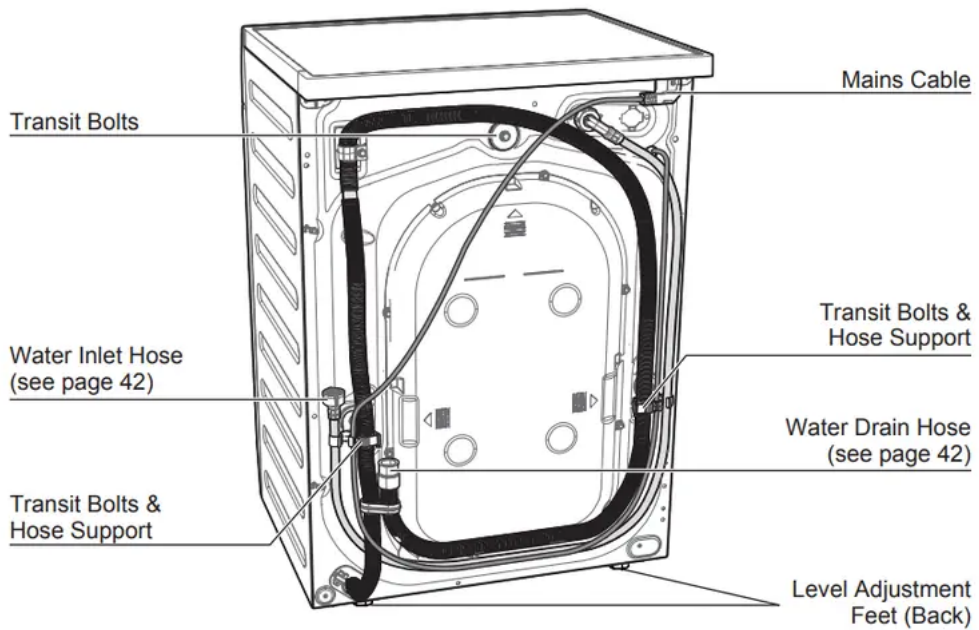

Detergent/Softener Dispenser

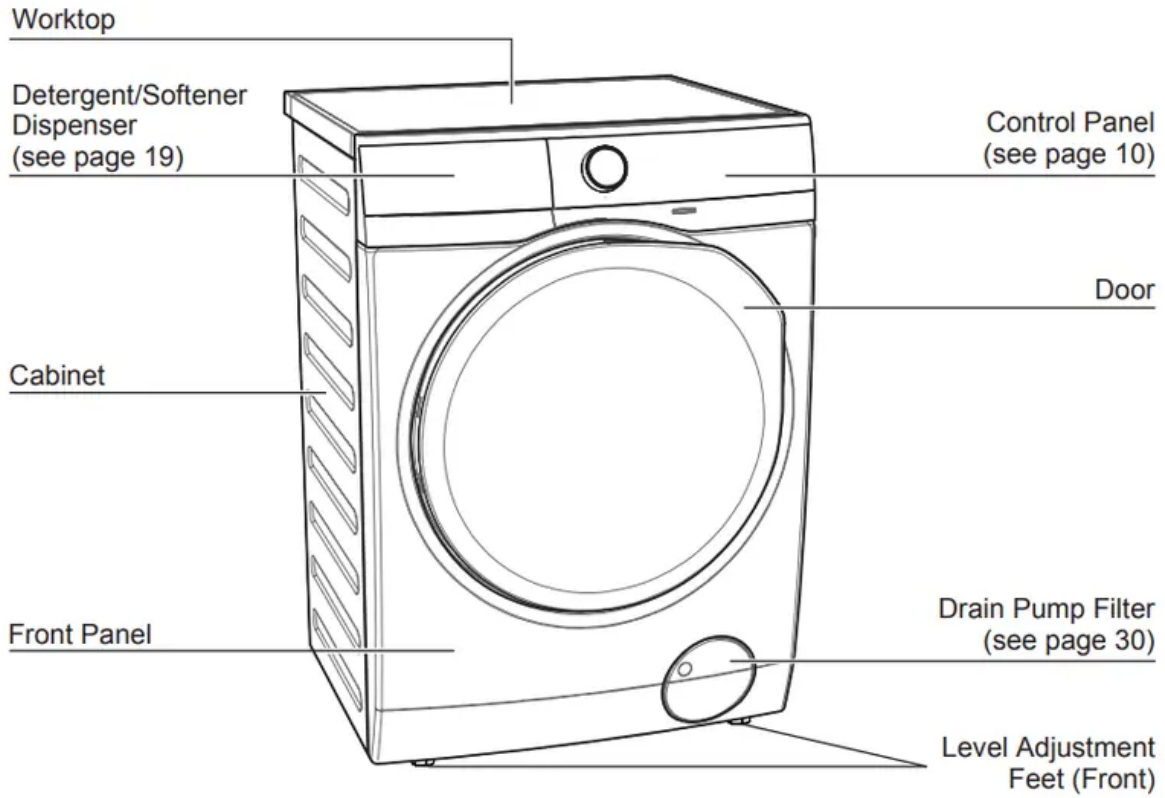

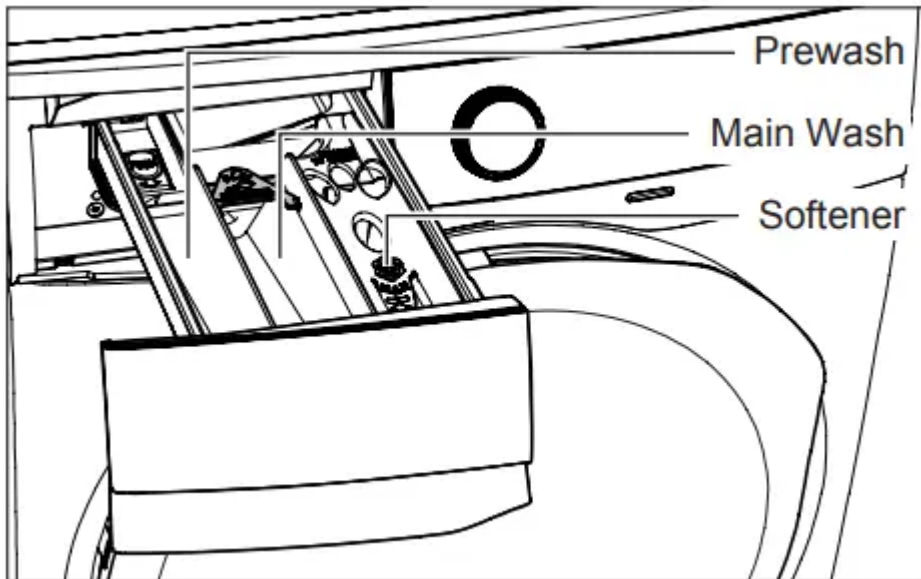

Door (when open)

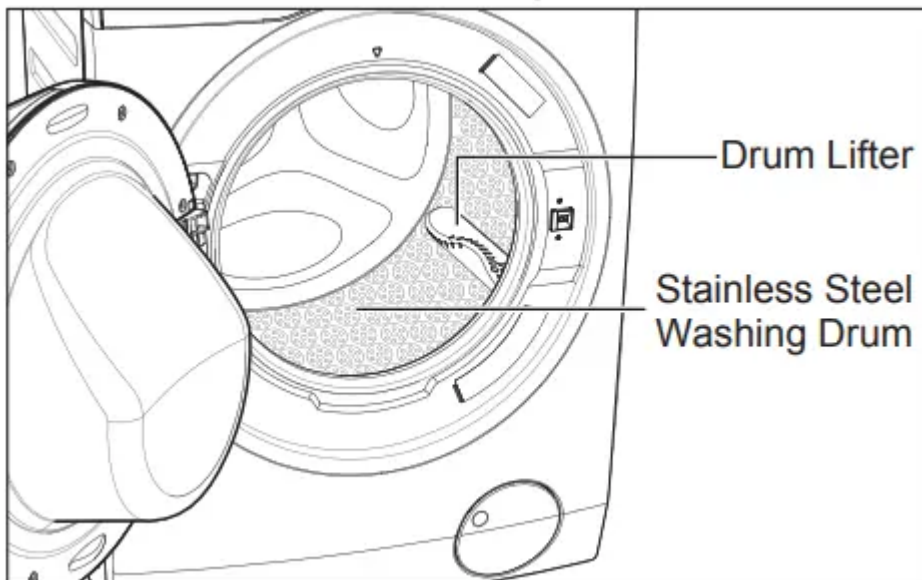

Drain Pump Filter (when open)

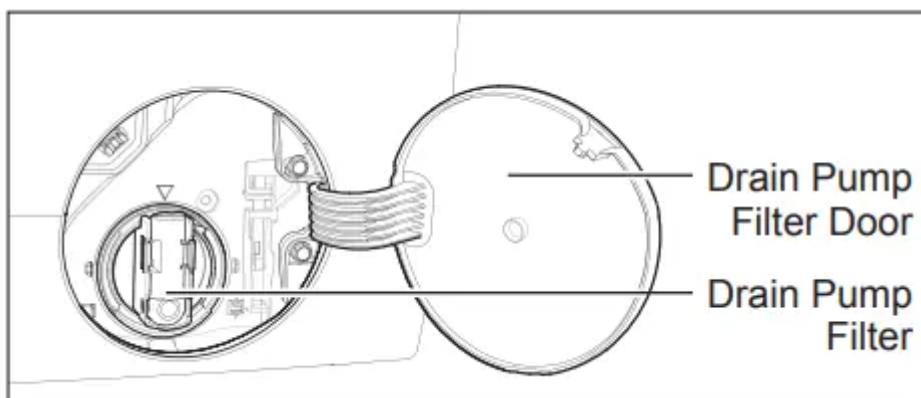

Level Adjustment Feet



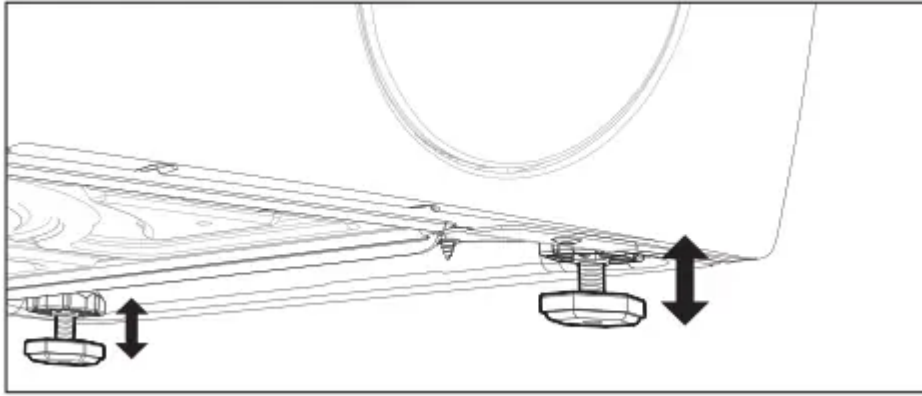

Transit Bolt (when remove)

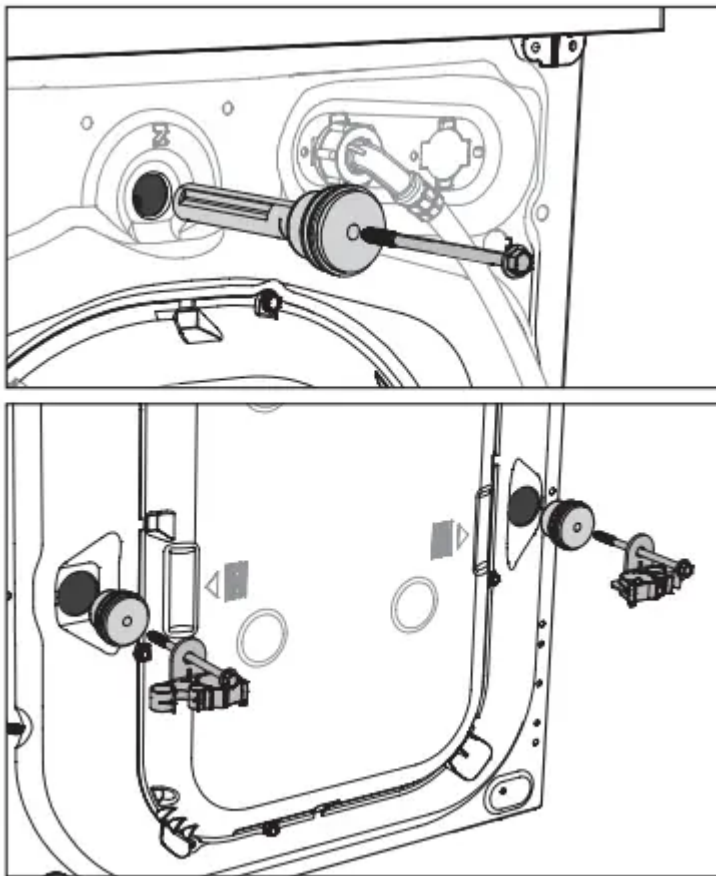

Transit bolts must be removed before using the appliance.

Accessories

Plastic Caps



To close the holes on the rear side of the cabinet after the removal of the transit bolts.

Plastic Hose Guide



To connect the drain hose on the edge of a sink.

Spanner



To remove the transit bolts. To adjust levelling legs.

CONTROL PANEL

Control Panel Description

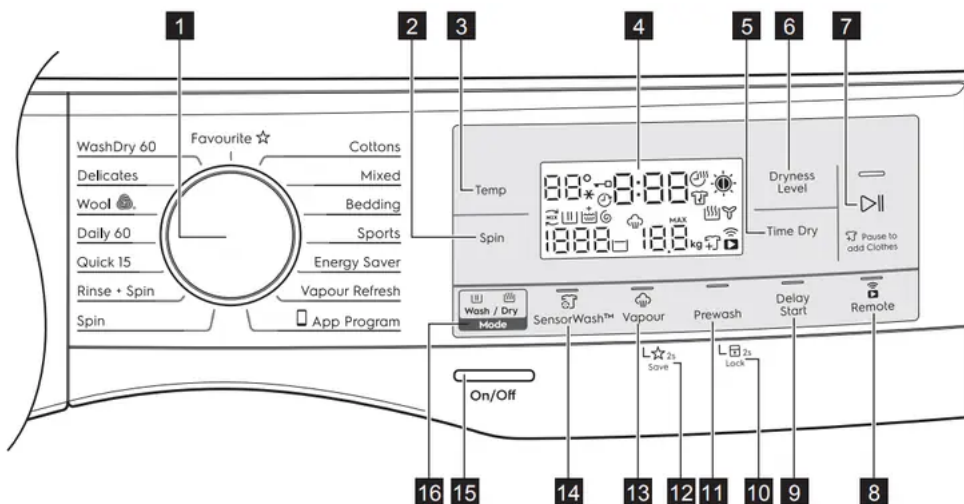



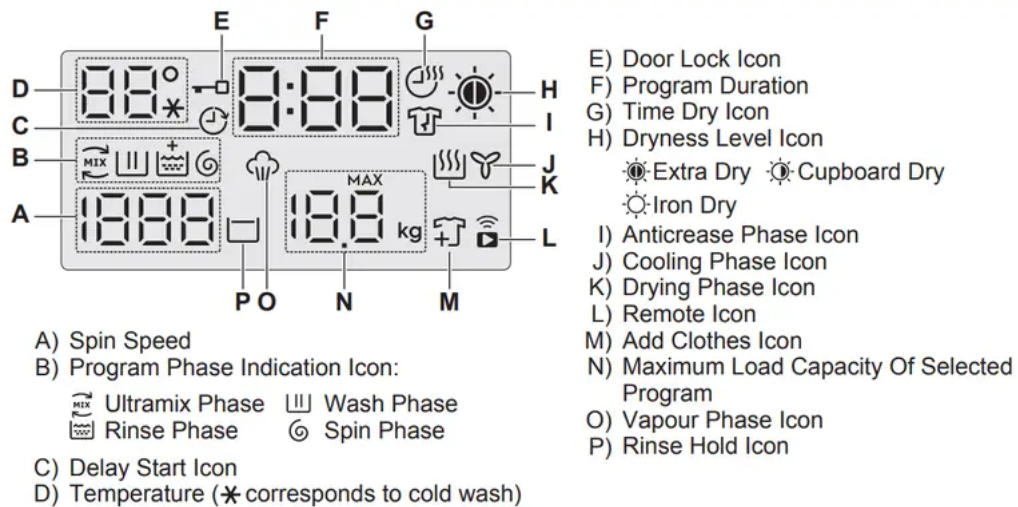

1. Program Selector Knob

2. Spin Selection Touchpad
3. Temperature Selection Touchpad
4. Display
5. Time Dry Touchpad
6. Dryness Level Touchpad
7. Start/Pause and Add Clothes Touchpad
8. Remote Touchpad
9. Delay Start Touchpad
10. Child Lock Option
11. Prewash Touchpad
12. Save Favourite Program Option
13. Vapour Touchpad
14. SensorWash Touchpad
15. On/Off Button
16. Wash/Dry Mode Selection Touchpad



Program Chart

Program; Temperature range	Max. Spin Speed	Max. Load (Dry Clothes)		Type of load and soil level
		Wash	Dry	
Cottons; Cold to 90°C	1400 rpm	10 kg	6 kg	White and coloured cotton.
Mixed; Cold to 60°C	1200 rpm	4 kg	3 kg	Synthetic or mixed fabric items.
Bedding; Cold to 60°C	800 rpm	3 kg	–	Special program for one synthetic blanket, duvet, bedspread and so on.
Sports; Cold to 40°C	1200 rpm	4 kg	–	A gentle program designed for mixed fabrics found in delicate clothes.
Energy Saver; Cold and 40°C ¹⁾	1400 rpm	10 kg	6 kg	White and colourfast cotton. Set this program to have a good washing results and decrease the energy consumption. The time of the washing program is extended.
Vapour Refresh	–	1.5 kg	–	This cycle removes odours and helps to dewrinkle the laundry.  Do not add detergent.
 App Program	–	–	–	You can send any additional program from Mobile Application to store at this program position and can recall to using it everytime when you rotate program knob to this position. This can be done through the App.  Program “Outdoor” is the default stored program from factory.
Spin	1400 rpm	10 kg	6 kg	To spin the laundry and drain the water in the drum.
Rinse + Spin	1400 rpm	10 kg	6 kg	To rinse and spin the laundry.
Quick 15; 30°C	800 rpm	1.5 kg	–	Lightly soiled synthetics or mixed fabrics.
Daily 60; 30°C to 60°C	1400 rpm	5.5 kg	4 kg	Coloured cotton e.g. shirts, blouses, towels and undergarments with normal level of soil.
Wool  ; Cold to 40°C	1200 rpm	2 kg	1 kg	Specially tested program for woollen garments bearing the “Pure new woollen, non-shrink, machine washable” label.
Delicates; Cold to 40°C	1200 rpm	4 kg	–	Delicate fabrics such as acrylics, viscose, polyester items.
WashDry 60; 30°C, 40°C	1200 rpm	1 kg	1 kg	Non-Stop washing and drying program for 3 - 5 shirts with lightly soil.
Favourite	–	–	–	Recall you favourite program.

1) Energy Saver program with 40degC and 1200rpm is recommended for a full load of normally soiled cottons, and is the Water and Energy rating label program.

Woolmark Apparel Care - Blue



The wool wash cycle of this machine has been approved by The Woolmark Company for the washing of wool garments labelled as “hand wash” provided that the garments are washed according to the instructions issued by the manufacturer of this machine. Follow the garment care label for drying and other laundry instructions. M1361 -The Woolmark symbol is a Certification mark in many countries.

Program Options Compatibility



Program	Option								
	--- No Spin	☐ Rinse Hold	Dryness ²⁾ Level	Time ²⁾ Dry	Delay Start	☐ Prewash	☁ ¹⁾ Vapour	☑ Sensor Wash	
Cottons	○	○	○	○	○	○	○	○	
Mixed	○	○	○ ³⁾	○	○	○	○	○	
Bedding	○	×	×	×	○	×	○	○	
Sports	○	○	×	×	○	○	×	○	
Energy Saver	○	○	○	○	○	○	○	×	
Vapour Refresh	×	×	×	×	○	×	○	×	
App Program	-	-	-	-	-	-	-	-	
Spin	○	×	○	○	○	×	×	×	
Rinse + Spin	○	○	○	○	○	×	×	×	
Quick 15	○	○	×	×	○	×	×	×	
Daily 60	○	○	○	○	○	×	×	×	
Wool	○	○	×	○	○	×	×	×	
Delicates	○	○	×	×	○	○	○	○	
WashDry 60	×	×	×	×	○	×	×	×	
Favourite	-	-	-	-	-	-	-	-	

- 1) Vapour option can be combined with temperature 40°C to 90°C only.
- 2) Do not select a spin speed LOWER than that proposed by the appliance to avoid a too long drying time so saving energy. In any case the reduction of the spin speed is only possible after selecting drying.
- 3) This program can select only “Cupboard Dry” option

Options

Wash/Dry Mode Touchpad

This touchpad is used to select Program Mode of your machine. Program mode available are :

-  Wash Only Mode (default)
-  Wash + Dry Mode
-  Dry Only Mode

If a mode is not compatible with program selected, the symbol “ --- ” will flash on display along with buzzer sound.

Changing a running program mode is possible only by switching off the machine.

Temperature Touchpad

Press this touchpad repeatedly to increase or decrease the wash temperature if you want your laundry to be washed at a temperature different from the one proposed by the Wahser-Dryer.

Spin Selection Touchpad

Press this touchpad repeatedly to increase or decrease the spin speed or select Rinse Hold, if you want your laundry to be spun at a speed different from the one proposed by the Wahser-Dryer.

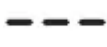
- **No Spin** ()

No spin option eliminates all the spin phases and increase the number of rinses.

- **Rinse Hold** ()

By selecting this option the water of the last rinse is not emptied out and the drum turns regularly to prevent the laundry creases. The door is still locked to indicate that the water must be emptied out.

SensorWash™ () Touchpad

Select “ SensorWash™ ” option to turn ON the sensors for the dirt and detergent residue

When using this option, machine will automatically check the dirt level and detergent residue in your laundry. It will automatically adjust the washing time and numbers of rinses according to the load to make sure that your clothes are really clean.

The SensorWash technology consist of 2 different sensors for detection:

1. The 1st Turbidity sensor detects the dirt level at the start of cycle and automatically calculates the actual time needed to remove the level of dirt in the wash; from low dirt levels all the way to the maximum dirt level.
2. The 2nd Conductivity sensor will check the amount of detergent residue after the first rinse and the machine will calculate the optimum number of rinses (Maximum of 2 additional rinses) needed to make sure that the detergent residue is properly removed.

Vapour () Touchpad

Select this option to add approximately 30 minutes of tumbling in vapour during the wash cycle. Vapour helps open fabric fibers up to allow laundry additives to release tough stains. The indicator of this option will be on.

- Vapour may not necessarily be visible inside the drum during a vapour wash cycle. Vapour is created below the drum and allowed to naturally rise into the clothes.
- Vapour may not be present during the entire vapour wash cycle.
- Vapour function is more effective with half load.
- At the end of the Vapour cycle, the clothes will be warmer, softer and detached from the drum.

NOTE

If Vapour option is selected, rinse temperatures will be elevated.

During a vapour cycle, you may notice vapour exiting from the drain hose of the Wahser-Dryer, this is normal and there is no cause for alarm.

Prewash Touchpad

Select this option if you wish your laundry to be pre-washed before the main wash. Use this option for heavy soil. The indicator of this option will be on.

When you set this function, put the detergent into the “  ” compartment. This function increases the program duration.

Delay Start Touchpad

This option makes it possible to delay the start of the program by 30 min, 60 min or 90 min and then by every hour from 2 to 20 hours. The delay you have selected is indicated on the display. The end time will increase in order to show you the selected delay.

You must select this option after you have set the program and before you press the Start/ Pause button. If you wish to add laundry in the machine during the delay time, press Start/ Pause touchpad to put the machine in pause mode. Add laundry, close the door and press Start/Pause touchpad again.

You can cancel the delay time at any moment, by pressing “Delay Start” touchpad repeatedly till the display shows delay time “ 0 ”, then press the Start/Pause touchpad.

Remote () Touchpad

This option allows you to connect washer-dryer to Wi-Fi network and to link it to your smart phone.

By this functionality you can receive notifications, control and monitor your washer-dryer from your mobile devices.

To connect the washer-dryer with your smart phone you need:

- Wireless network at home with internet connection enabled.
- Smart Phone connected to wireless network.



WI-FI specification requirements:

- **Frequency** -2.4 GHz according to local country regulation
- **Protocol**- IEEE 802.11b/g/n
- **Max Power**-According to local country regulation

Connection setting and other suggestions please refer to attached leaflet of this user manual.

Dryness Level Touchpad

Press this touchpad to set dryness level using auto sensing feature. The display will show the selected option.

- Extra dry 
- Cupboard dry 
- Iron dry 

NOTE

- Dryness level settings are based on wash program selected.
- The final time value is the total duration of the washing + detachment + drying cycles, calculated on a default load size.
- At the end of the program the appliance performs the anti-crease phase for approximately 10 minutes. During this time, the display will show time remaining “

End” and door is locked “  ”.



If you wish to open the door during the anti-crease phase or interrupt it, press Start/Pause touchpad.

Dryness Option Guidelines:

Level of dryness	Type of fabric	Load
Extra Dry Ideal for towels or similar	Cotton and linen (bathrobes, bath towels, etc)	up to 6 kg
Cupboard Dry Suitable for items to put away without ironing	Cotton and linen (bathrobes, bath towels, etc)	up to 6 kg
	Synthetics and mixed fabrics (jumpers, blouses, underwear, household linen)	up to 3 kg
Iron Dry Suitable for ironing	Cotton and linen (sheets, tablecloths, shirts, etc.)	up to 6kg

Time Dry () Touchpad

If you wish to carry out a timed drying program, keep pressing this touchpad until the desired time is reached.

NOTE

- Maximum allowable timed drying changes based on wash program selected.
- The final time value is the total duration of the washing + detachment + drying cycles.
- At the end of the program the appliance performs the anti-crease phase for approximately 10 minutes. During this time, the display will show time remaining “**End**” and door is locked “”.





If you wish to open the door during the anti-crease phase or interrupt it, press Start/Pause touchpad.

Dry Time Option Guidelines:

Type of fabric	Load (kg)	Spin Speed (rpm)	Suggested Times (Hrs)
Cotton and linen (bathrobes, bath towels, etc.).	5-6	1400	3 - 4
	3-5	1400	2 - 3
	2-3	1400	1 - 2
Synthetic or mixed fabric items (jumpers, blouses, underwear, household linen, etc.).	3	1200	2 - 3
	1	1200	1
Wool and hand washable wool.	1	1200	2



Duration of the drying cycle

The drying time can vary according to :

- the final spin speed;
- dryness level (Extra Dry or Cupboard Dry or Iron Dry);
- the type of laundry;
- the size of load.



Additional drying

Should the laundry still be too wet at the end of the program, set another short drying cycle.

- The final part of a washer- dryer cycle occurs without heat (cool down cycle). This ensures the laundry will be left at a low temperature.

• **WARNING!**

To prevent the formation of creases or shrinking of fabrics, avoid excessive drying.

Settings

Save Favourite () Program

Program settings that are frequently used can be saved (e.g. Cotton, 60°C, 1200 rpm, with Prewash and Vapour).

To program/re-program Favourite with your own selections and save them, proceed as follows:

1. Put machine in Stand-By mode.
2. Select your desired wash settings.
3. To save favourite program, press and hold “Vapour ()” touchpad about seconds and you will hear “Bip, Bip” sound and “Favourite” LED is flashing .

To recall the favourite wash program, turn selector knob to “Favourite ” program. You will get acknowledgement on the display when the Favourite program is loaded.

Child Safety Lock () Option

Your appliance is provided with CHILD SAFETY LOCK which permits you to leave the appliance unsupervised with the door closed without having to worry that children might be injured by or cause damage to the appliance.



Set this option after pressing the Start/Pause touchpad.

To set “Child Lock” option:

To activate the function, press and hold “Prewash” and “Delay Start” touchpads about 3 seconds until the display shows the icon “  ”.



If you press any touchpad while Child Lock is activated, the icon “  ” will flash on display 3 times along with buzzer sound.



The touchpads are locked (except for the On/Off button).



This function remains enabled even after the appliance is switched off.

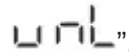



To deactivate the function, press and hold “Prewash” and “Delay Start” touchpads about 2 seconds until the display shows the icon “  ”.

Enabling/Disabling End-Of-Wash Buzzer

This setting permits you to either enable or disable the buzzer at the end of the program. As an example, you might wish to disable this buzzer when you start a wash when going to bed, so that when the wash finished approximately 1 hour later, it will not disturb you through the night.



Error warning beeps such as critical faults are not disabled.

- To disable the buzzer sound, press “SensorWash ()” and “Vapour ()” touchpads at the same time about 3 seconds, the icon “  ” will show on display along with buzzer sound.
- To return to default configuration press these 2 touchpads at the same time about 3 seconds, the icon “  ” will show on display along with buzzer sound.

Start/Pause () and Add Clothes () Touchpad

This touchpad has 2 functions:

1. Start/Pause ()

After you have selected the desired program and options, press this touchpad to start the machine. The Start/Pause pilot light will stop flashing and remain lit until the water level is above the bottom edge of the door then pilot light goes OFF.

If you have selected a “Delay Start” option, the countdown will begin and will be shown on the display.

To interrupt a program which is running, press this touchpad to pause the machine, the Start/Pause pilot light flashes.

To restart the program from the point at which it was interrupted, press this touchpad again, the Start/Pause pilot light will stop flashing.

2. Add Clothes ()

You can only add clothes when the icon “  ” shown on the display.

To add clothes:

01. Pressing the “Start/Pause” touchpad to pause the program.
02. Wait for the machine to come to a complete stop before opening the door (wait for door lock “  ” icon to turn off).
03. Add clothing and close the door.
04. Resume the program by pressing Start/Pause” touchpad again.

BEFORE FIRST USE

1. Ensure that the electrical and water connections comply with the installation instructions.
2. Put 2 litres of water in the detergent compartment for washing phase. This activates the drain system.

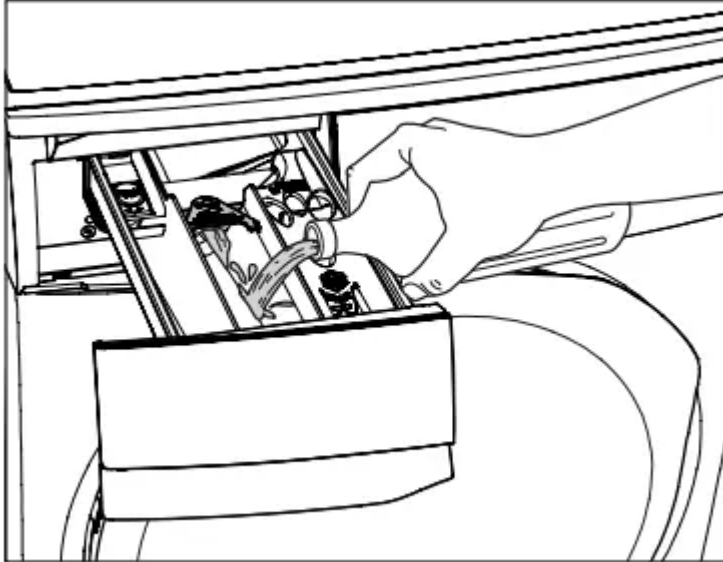

3. Select a Cottons cycle at 90 °C, without any laundry in the machine, to remove any manufacturing residue from the drum and tub then start the machine.

DAILY USE - WASHING (Only)

Loading The Laundry

1. Turn the water tap on.
2. Connect the main plug to the main socket.
3. Press the On/Off button to turn on the Wahser-Dryer. Turn the knob to set a program. The Wahser-Dryer will propose a temperature and automatically select the spin value provided for the program you have chosen. The selector knob can be turned either clockwise or counter-clockwise.

4. Check and remove objects (if there are any) that could be trapped in the fold.

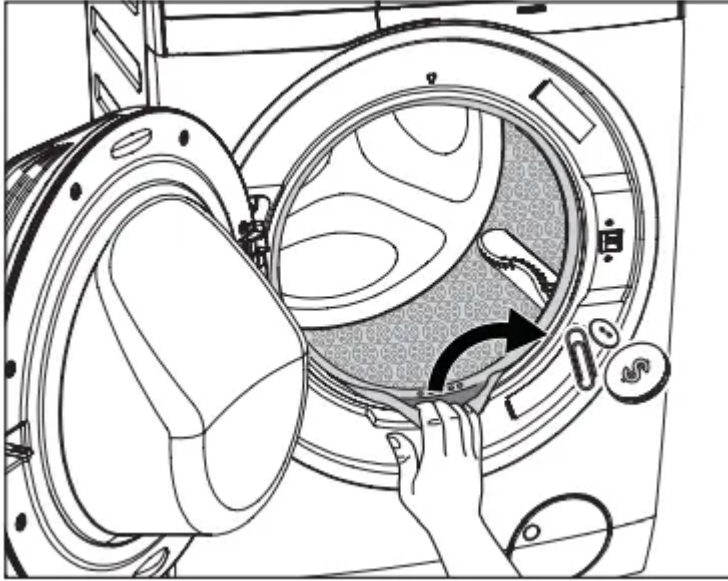

5. Place the laundry in the drum, one item at a time, shaking them out as much as possible.

6. Close the door.



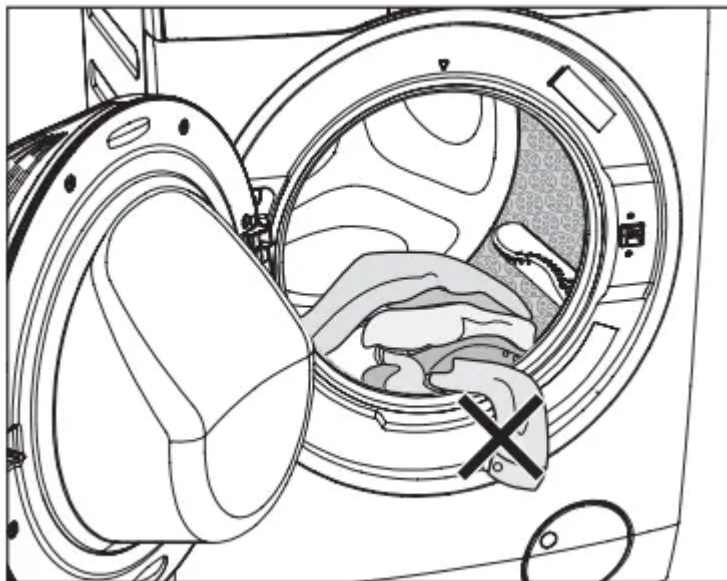

Make sure that no laundry ' remains between the seal and the door.

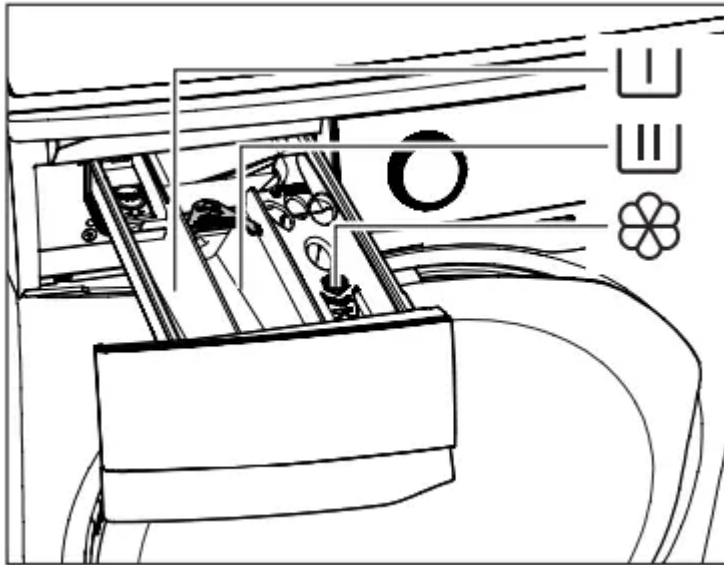

Using Detergent And Additives

1. Detergent Dispenser Drawer The detergent dispenser is divided into three compartments.



- 
 Compartment "PREWASH"
 This compartment is only used for detergent when a "Prewash" option is selected.

- 
 Compartment "MAIN WASH"
 This compartment is used for detergent on all programs.

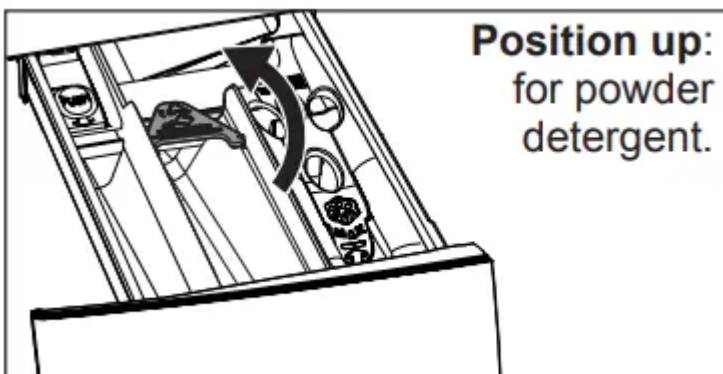
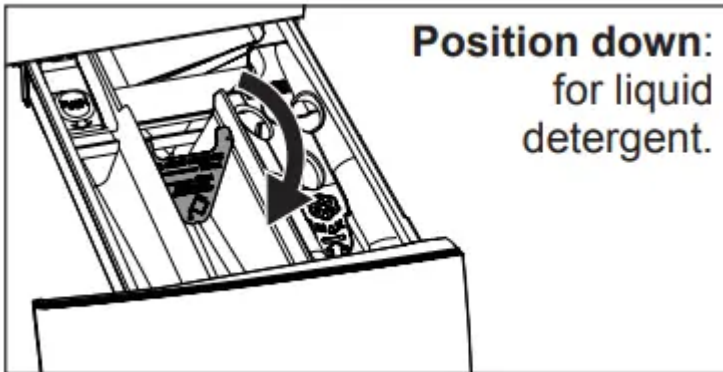



Compartment "SOFTENER"

This compartment is used for fabric conditioner and starching agent.



When you use the liquid detergent

- Do not use gelatinous or thick liquid detergents.
- Do not put more liquid than the maximum level.
- Do not set the "Prewash" phase.
- Do not set the "Delay Start".

2. Measure out the detergent and the fabric softener;

- Pull out the dispenser drawer until it stops.
- Measure out the amount of detergent required, pour it into the main wash compartment

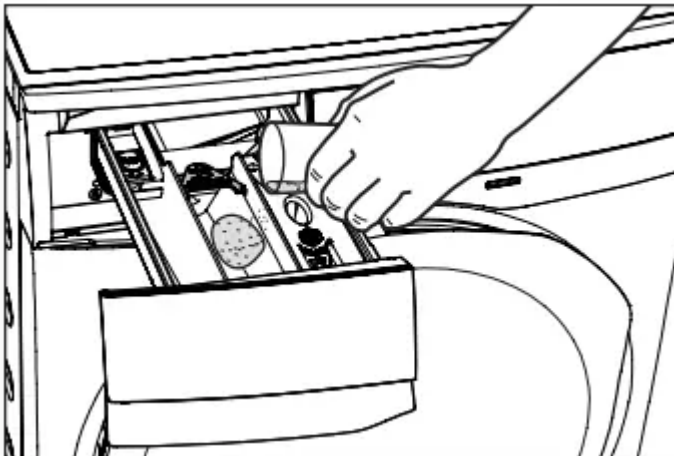

- If you wish to carry out the "Prewash" phase, pour it into the compartment marked

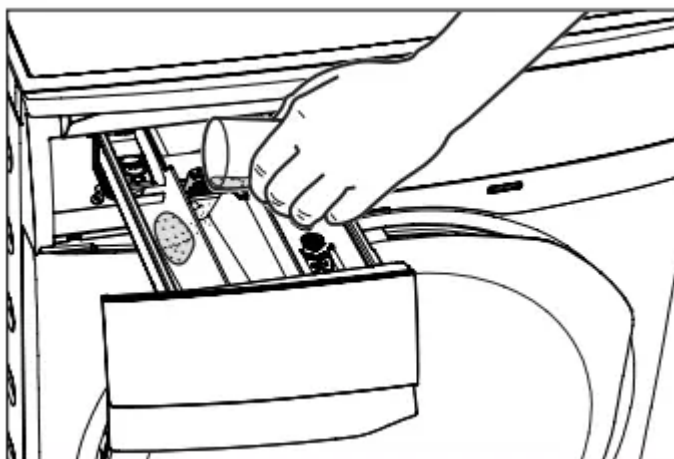

- If required, pour fabric softener into the compartment marked 

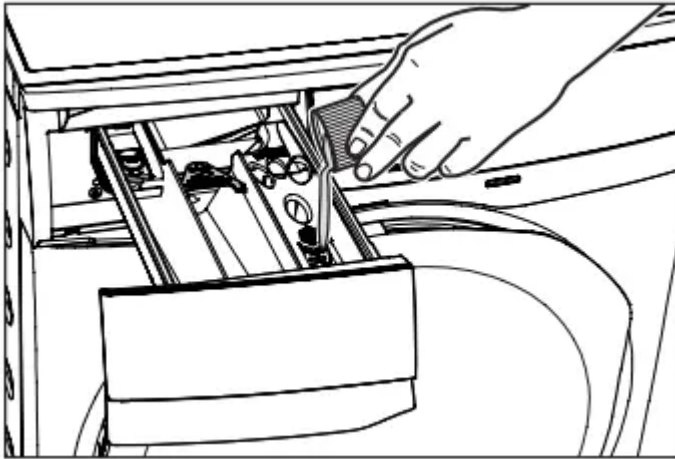

- Close the drawer gently.

Options Setting

1. If you want your laundry to be spun or use temperature different from the one proposed by the Wahser-Dryer, press "Spin" and "Temp" touchpads repeatedly to change the spin speed and temperature.
Press the option touchpads, if you want your laundry to be washed with special functions.
2. If you want to delay the start of the program, press the "Delay Start" touchpad repeatedly to choose your Wahser-Dryer delay time.

Starting A Cycle ()

To start a program, press the Start/Pause touchpad. The corresponding pilot light will stop flashing and a default program duration will be displayed on the screen.

After approx. 15 minutes from the start of a program:

- The appliance will automatically adjust the selected program duration according to the type and size of the load.
- The display will show adjusted program duration.

Interruption Of A Program

- To pause, press Start/ Pause.
The indicator will start flashing.
- Press the Start/Pause again.
The program will continue.

Changing A Program

Changing a running program is possible only by switching off the appliance.

- Press the “On/Off” button to cancel the program and to turn off the appliance.
- Press the “On/Off” button again to start the appliance.

Now you can set a new wash program and change any available options. Press Start/Pause to start the new program.

Changing The Options



It may be possible to change some of the options after a program has started.

1. Press the touchpad Start/Pause. The indicator will start flashing.
2. If available change the options that you wish.
3. Press Start/Pause again. The program will continue.

Opening The Door

While a program or the Delay Start is operating, the appliance door is locked and the display shows the indicator “”. First, set the machine to PAUSE by pressing the “Start/Pause” touchpad. Wait until the door lock indicator goes off, then the door can be opened.

If the door lock indicator “” does not disappear, this means that the machine is already heating and the water level is above the bottom edge of the door or the drum is turning. In this case the door CAN NOT be opened. If you need to open it, you must drain the water to open the door.

In case of Remote () function is activated, when program cycle end and anticrease phase is complete. The door will remain locked for 5 minutes, if you want to open the door at that time, press Remote () touchpad once to turned off function then the door is unlocked.



In case of emergency please refer to “Emergency door opening” on page 37.

At The End Of The Program

- The appliance stops automatically.
- The acoustic signal will operate.
- The display will show “End”.
- The indicator of the touchpad Start/Pause goes off.
- The door lock indicator “” goes off.

- Remove the laundry from the appliance. Make sure that the drum is empty.
- Keep the door partly open, to prevent the mildew and odours.
- Turn off the water tap.

When The Washing Program Is Completed, But There Is Water In The Drum



(Option “Rinse Hold  ” is used)

- The drum turns regularly to prevent the creases in the laundry.
- The indicator “Start/Pause” flashes to remind you to drain the water.
- The door lock indicator “  ” is on. The door stays locked.



You must drain the water to open the door.

To drain the water:

1. Press the “Start/Pause  ” touchpad. The appliance drains the water and spins with the maximum spin speed for selected program.
Alternatively, before pressing the “Start/Pause” touchpad, you can press the “Spin ” touchpad to change the spin speed. You can select “No Spin ()” if you want the machine to only drain the water.
2. When the program is completed and the door lock indicator “  ” goes off, you can open the door.
3. Press the “On/Off” button to deactivate the appliance.









After approximately 18 hours, if you do not press Start/Pause touchpad, the appliance will drain and spin automatically (except for “Wool” program) .

AUTO Off Mode

The AUTO Off mode automatically deactivates the appliance to decrease the energy consumption when:

- You do not press any buttons for 5 minutes before you press “Start/Pause”.
 - Press the “On/Off” button to activate the appliance again.
- After 5 minutes from the end of the washing program.
 - Press the “On/Off” button to reactivate the appliance. Display will show the end of the last wash.
 - Press any touchpad again to show the last wash program.

DAILY USE - DRYING (Only)

1. Press the On/Off button to turn on the machine. positioned in the sink or connected to the drain pipe.
2. Load the laundry. Make sure the load size does not exceed the maximum drying capacity of the machine.
3. Turn the knob to set a wash program which can select drying option (refer to Program Chart on page 11), according to your clothes then press Wash/Dry Mode touchpad to switch your machine to Dry Only () mode.
4. If you wish to select an automatic drying, press the “Dryness Level” option until the icon corresponding to the required dryness level appears on the display. (see page 15)
5. If you wish to select a timed drying, press the “Time Dry  ” option repeatedly until desired drying time reached.
6. Press “Start/Pause  ” touchpad to start the program. The time remaining is updated every minute.
7. At the end of the program :
 - The acoustic signal will operate.
 - The display will show “End” and “Anti Crease ()” icon is lit.
 - The door lock indicator “  ” is still on.
 - The appliance will perform the anticrease phase for approximately 10 minutes. After anti-crease phase finish, the door lock indicator “  ” goes off. The display will show “End”.
8. Press “On/Off” button to switch the machine off.
9.  At the end of each drying cycle, the temperature of your clothing will be high. For your safety, please leave the door open to let your clothes cool before removing your laundry.

DAILY USE - WASHING & DRYING (Non-Stop Program)

Washing Program + “Dryness Level” Option



1. Load the laundry and add detergent and fabric softener. Make sure the load size does not exceed the maximum drying capacity of the machine.

2. Turn the knob to set a wash program which can select drying option (refer to Program Chart on page 11), according to your clothes then press Wash/Dry Mode touchpad to switch your machine to Wash and Dry () mode.
3. Select the required options by pressing the relevant touchpads. If possible, do not select a spin speed lower than that proposed by the machine to avoid unnecessary longer drying time therefore saving energy.
4. Set the dryness level by pressing “Dryness Level” touchpad.
The display will then show the whole duration of wash & dry cycle.
5. Start the program by pressing Start/Pause touchpad. The time remaining is updated every minute on the display.
6. At the end of the program press the On/Off button to switch the machine off.





At the end of each drying cycle, the temperature of your clothing will be high. For your safety, please leave the door open to let your clothes cool before removing your laundry.

NOTE

- If you wish to open the door during the anti-crease phase or interrupt it, press Start/Pause touchpad.
- Some drying level options are not available for some programs.
- When “Iron Dry  - ” option is selected, the display time will be adjusted after approximately 15 minutes from the start of the program, based on the laundry type and load size.
- The display will show the new adjusted time.
- When “Extra Dry  ” or “Cupboard Dry  ” is selected the display time will be adjusted towards the end of the drying cycle when machine senses required dryness level has been achieved. In case of laundry quantity lower than maximum load capacity, the time remaining can suddenly decrease from e.g. approximately **50** minutes to **0**.

Washing Program + “Time Dry ” Option

1. Load the laundry and add detergent and fabric softener. Make sure the load size does not exceed the maximum drying capacity of the machine.
2. Turn the knob to set a wash program which can select drying option (refer to Program Chart on page 11), according to your clothes then press Wash/Dry Mode touchpad to switch your machine to Wash and Dry () mode

3. Select the required options by pressing the relevant touchpads. If possible, do not select a spin speed lower than that proposed by the machine to avoid unnecessary longer drying time therefore saving energy.
4. Set the drying time by pressing “Time Dry ” touchpad repeatedly until desired drying time reached. The display will then show the whole duration of wash & dry cycle.
5. Start the program by pressing Start/Pause touchpad. The time remaining is updated every minute on the display.
6. At the end of the program press the On/Off button to switch the machine off.



At the end of each drying cycle, the temperature of your clothing will be high. For your safety, please leave the door open to let your clothes cool before removing your laundry.

NOTE

- If you wish to open the door during the anti-crease phase or interrupt it, press Start/ Pause touchpad.
- If you set only 10 minutes of drying, the appliance performs only a Cooling phase.

WASHING HINTS

Sorting The Laundry

Follow the wash code symbols on each garment label and the manufacturer's washing instructions. Sort the laundry as follows: whites, coloureds, synthetics, delicates, woollens.

Temperatures

Temp	Soil level
90°C	For normally soiled white cottons and linen (e.g. teacloths, towels, tablecloths, sheets...).
60°C 50°C	For normally soiled, colourfast garments (e.g. shirts, night dresses, pajamas....) in linen, cotton or synthetic fibres and for lightly soiled white cotton (e.g.underwear).
40°C 30°C Cold	For delicate items (e.g. net curtains), mixed laundry including synthetic fibres and woollens bearing the label pure new wool, machine washable, non-shrink.

Before Loading The Laundry

- Make sure that no metal objects are left in the laundry (e.g. coin, hair clips, safety pins, pins).





- Button up pillowcases, close zip fasteners, hooks and poppers. Tie any belts or long tapes.

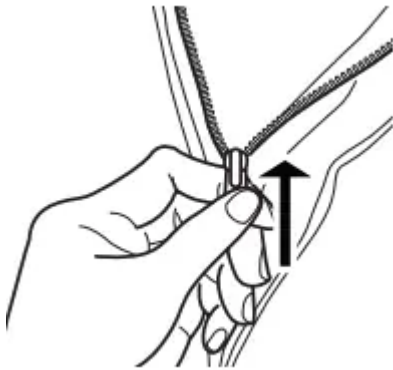

- Wash bras, pantyhose and other delicates in a mesh laundry bag, which you can purchase from your supermarket.

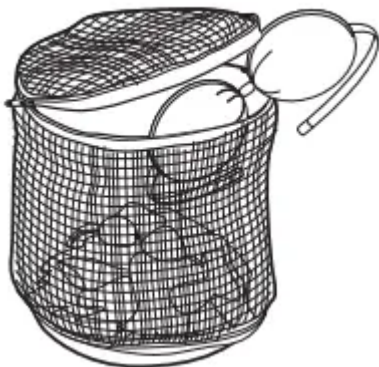

- Make sure that you wash lint collectors separately from lint producers.
- Never wash whites and coloured fabrics together. Whites may lose their “whiteness” in the wash.
- New coloured items may run in the first wash; they should therefore be washed separately the first time.
- Remove persistent stains before washing. ms may run in the first wash; they should therefore be washed separately the first time.
- Rub particularly soiled areas with a special detergent or detergent paste. Treat curtains with special care. Remove hooks or tie them up in a bag or a net.

Maximum Loads

Recommended loads are indicated in the program charts on page 11.

General rules:

Clothes Load	Quantity
Cotton, linen	drum full but not too tightly packed;
Synthetics	drum no more than half full;
Delicate fabrics and woollens	drum no more than one third full.

Washing a maximum load makes the most efficient use of water and energy. For heavily soiled laundry, reduce the load size.

Removing Stains

Stubborn stains may not be removed by just water and detergent. It is therefore advisable to treat them prior to washing.

Blood: treat fresh stains with cold water. For dried stains, soak overnight in water with a special detergent then rub in the soap and water.

Oil based paint: moisten with benzine stain remover, lay the garment on a soft cloth and dab the stain; treat several times.

Dried grease stains: moisten with turpentine, lay the garment on a soft surface and dab the stain with the fingertips and a cotton cloth.

Rust: oxalic acid dissolved in hot water or a rust removing product used in cold water. Be careful with rust stains which are not recent since the cellulose structure will already have been damaged and the fabric tends to hole.

Mould stains: treat with bleach, rinse well (whites and fast coloureds only).

Grass: soap lightly and treat with bleach (whites and fast coloureds only).

Ball point pen and glue: moisten with acetone (*), lay the garment on a soft cloth and dab the stain.

Lipstick: moisten with acetone (*) as above, then treat stains with methylated spirits. Remove any residual marks from white fabrics with bleach.

Red wine: soak in water and detergent, rinse and treat with acetic or citric acid, then rinse. Treat any residual marks with bleach.

Ink: depending on the type of ink, moisten the fabric first with acetone (*), then with acetic acid; treat any residual marks on white fabrics with bleach and then rinse thoroughly.

Tar stains: first treat with stain remover, methylated spirits or benzene, then rub with detergent paste.

(*) do not use acetone on artificial silk.

Detergents Type And Quantity Of Detergent

Low sudsing detergent is required for this Wahser-Dryer to prevent oversudsing problems, unsatisfactory washing result and harm to the machine.

Low sudsing detergents designed for front load washing machines are labelled "Front Loading", "high efficiency", "HE", such as Cold Power for Front Loaders or "Matic".

Do not use wrong types of detergent, such as Top Loading, Handwash detergent or Soap-Based products in your frontload Wahser-Dryer. This can result in excessive suds, longer cycle time, low spin speeds, poor rinsing and overloading of the motor.

Quantity of detergent to be used

The choice of detergent and use of correct quantities not only affects your wash performance, but also helps to avoid waste and protect the environment. Although biodegradable detergents contain substances which in large quantities can upset the delicate balance of nature.

The choice and quantity of detergent will depend on ;

- type of fabric (delicates, woollens, cottons, etc.) ;
- the colour of clothes ;
- size of the load ;

- degree of soil ;
- wash temperature ; and
- hardness of the water used.

Water hardness is classified by so-called “degrees” of hardness.

Information on hardness of the water in your area can be obtained from the relevant water supply company, or from your local authority.

You may have to try using the detergent quantity as per manufacturers' instructions then compare the wash result to the list below and adjust the amount of detergent for your future washes accordingly.

Not enough detergent causes:

- the washload to turn grey,
- greasy clothes.

Too much detergent causes:

- oversudsing,
- reduced washing effect,
- inadequate rinsing.

Use less detergent if:

- you are washing a small load,
- the laundry is lightly soiled, I
- arge amounts of foam during washing.

DRYING HINTS

Preparing The Drying Cycle

As a dryer, the appliance works on condensation principle.

Therefore, the water tap must be open and the drain hose must drain water into a sink or into the drain pipe, even during the drying cycle.

Laundry Not Suitable For Drying

- Particularly delicate items such as synthetic curtains, woollen and silk, garments with metal inserts, nylon stockings, bulky garments such as anoraks, bed covers, quilts, sleeping bags and duvets must not be machine dried.
- Avoid drying dark clothes with light coloured fluffy items such as towels as these can attract fluff.

- Remove the laundry when the appliance has finished drying.
- To avoid a static charge when drying is completed, use either a fabric softener when you are washing the laundry or a fabric conditioner specifically for tumble dryers.
- Garments padded with foam-rubber or materials similar to foam-rubber must not be machine dried; they represent a fire hazard.
- Also, fabrics containing residue of setting lotions or hair sprays, nail solvents or similar solutions must not be machine dried to avoid formation of harmful vapours.

The detergent and any additives must be placed in the appropriate compartments of the dispenser drawer before starting the wash program.

Garment Labels

For drying, follow the indications given on the manufacturer's labels:

 = May be tumble dried

 = Drying at high temperature

 = Drying at reduced temperature

 = Do not tumble dry

Drying Cycle Duration

The drying time may vary depending on:

- speed of the final spin;
- dryness level required (Extra dry, Cupboard dry, Iron dry);
- type of laundry;
- weight of the load.

The average drying time for a timed drying are indicated in the “Time Dry  ” option (see page 14). The experience will help you to dry your laundry in a more suitable way according to the different fabrics.

Additional Drying

































If the laundry is still damp at the end of the drying program, select a short drying cycle again.

WARNING!

Do not over dry the laundry in order to avoid creasing of fabrics or garments shrinking.

INTERNATIONAL WASH CODE SYMBOLS

These symbols appear on fabric labels, in order to help you choose the best way to treat your laundry.

 Energetic wash	 Max. wash temperature 95 °C	 Max. wash temperature 60 °C	 Max. wash temperature 40 °C	 Max. wash temperature 30 °C	 Hand wash	 DO NOT wash at all
 Delicate wash			 			
 Bleaching	 Bleach in cold water			 DO NOT bleach		
 Ironing	 Hot iron max. 200 °C	 Warm iron max. 150 °C	 Lukewarm iron max. 110 °C	 DO NOT iron		
 Dry cleaning	 Dry cleaning in all solvents	 Dry cleaning in perchlorethylene, petrol, pure alcohol, R 111 & R 113		 Dry cleaning in petrol, pure alcohol and R 113	 DO NOT dry clean	
 Drying	 Flat	 On the line	 On clothes hanger	 High temperature  Low temperature Tumble dry	 DO NOT tumble dry	

CARE AND CLEANING

External Cleaning

Clean the appliance only with soap and warm water. Fully dry all the surfaces.

CAUTION!

Do not use alcohol, solvents or chemical products.

Descaling

The water we use normally contains lime. It is a good idea to periodically use a water softening powder in the machine.

Do this separately from any laundry washing, and according to the softening powder manufacturer's instructions.

This will help to prevent the formation of lime deposits.

After Each Wash

Leave the door open for a while. This helps to prevent mould and stagnant smells forming inside the appliance.

Keeping the door open after a wash will also help to preserve the door seal.

Maintenance Wash With “Tub Clean” Program

With the use of low temperature washes it is possible to get a build up of residues inside the drum.

We recommend to use “Tub Clean” program to clean the drum regularly to remove any residue.

To run a maintenance wash:

- The drum should be empty of laundry.
- Select the “Tub Clean” program.
- Press Start/Pause to start the program

Cleaning The Dispenser Drawer

The washing powder and additive dispenser drawer should be cleaned regularly.

Remove the drawer by pressing the catch downwards and by pulling it out.

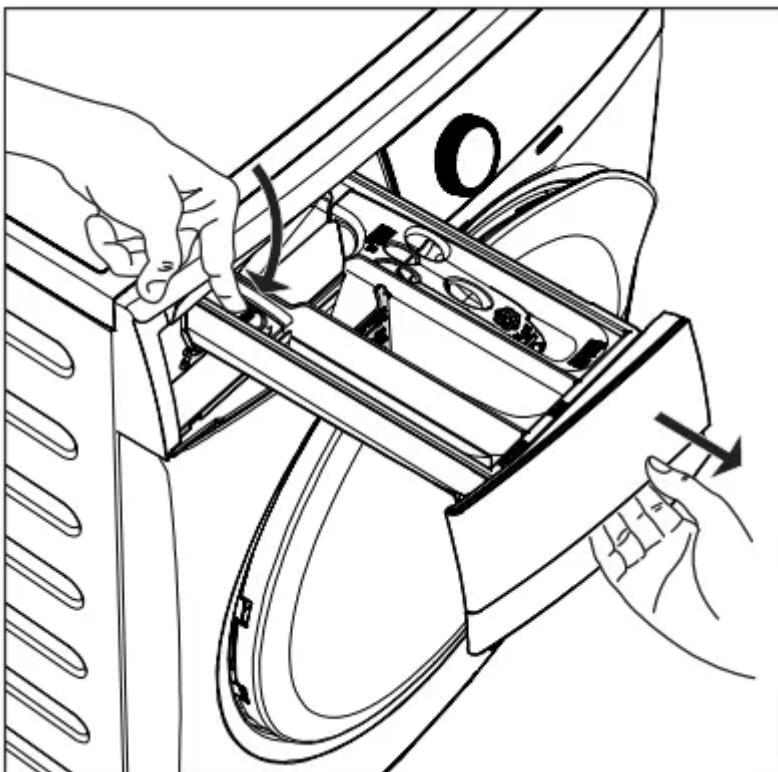

To aid cleaning, the top part of the additive compartment should be removed

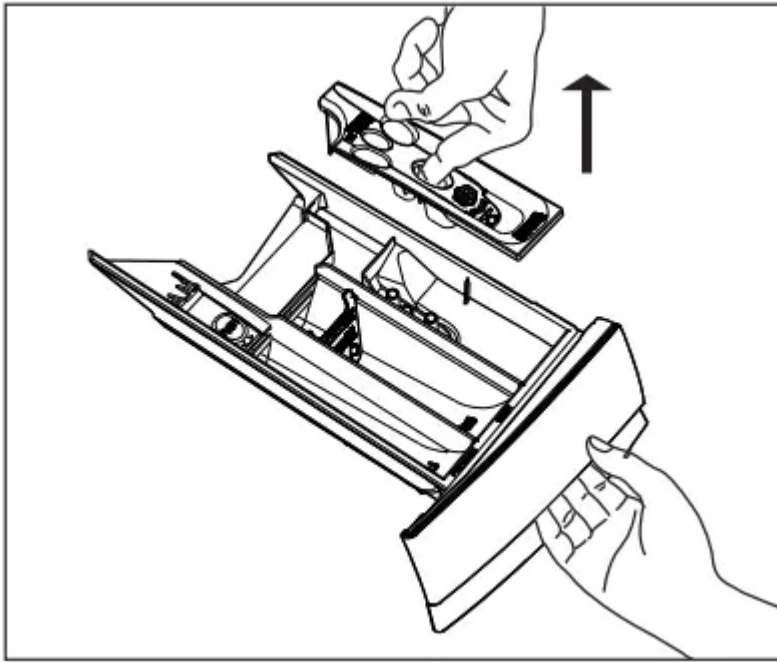

Flush it out under a tap to remove any traces of accumulated powder.

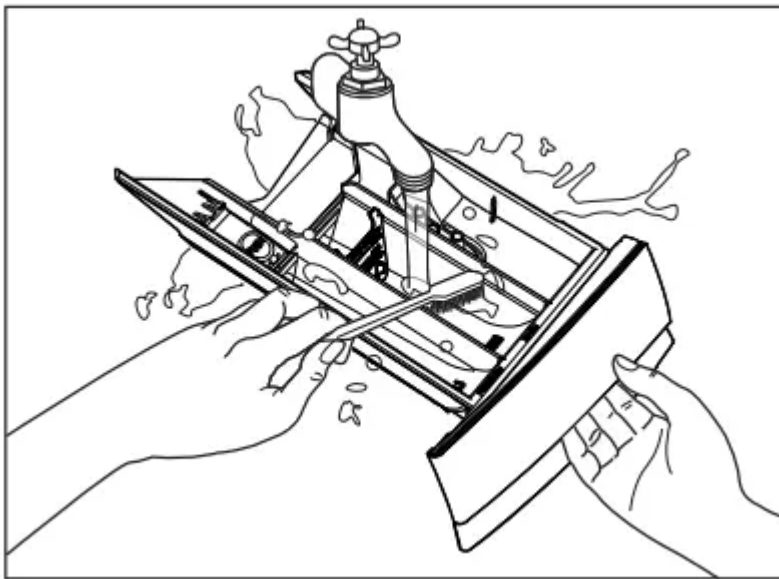

Cleaning The Drawer Recess

Having removed the drawer, use a small brush to clean the recess, ensuring that all washing powder residue is removed from the upper and lower part of the recess. Replace the drawer and run the rinse program without any clothes in the drum.

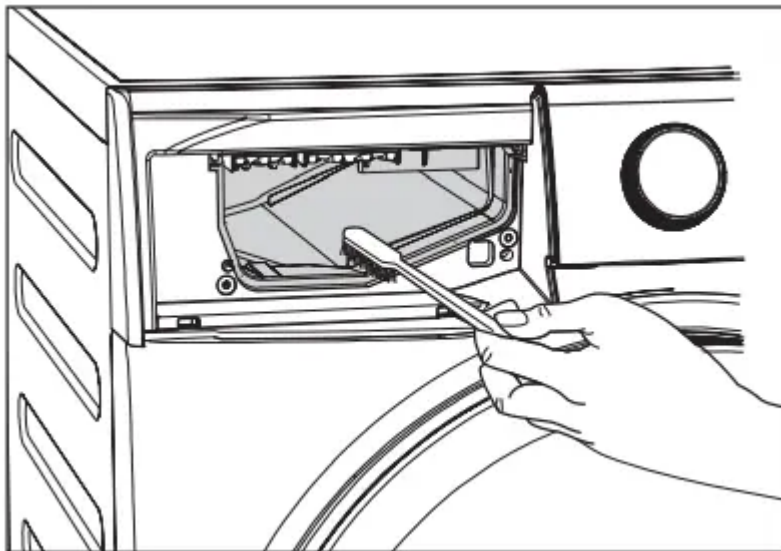

Cleaning The Pump

Clean the pump if:

- The appliance does not drain the water.
- The drum cannot turn.
- The appliance makes an unusual noise because of the blockage of the drain pump.
- The display shows an alarm code because of the problem with water drain.

WARNING

1. Disconnect the mains plug from the mains socket.
2. Do not remove the filter while the appliance is operating. Do not clean the drain pump if the water in the appliance is hot. The water must be cold before you clean the drain pump.

To clean the drain pump:

1. Open the drain pump door.

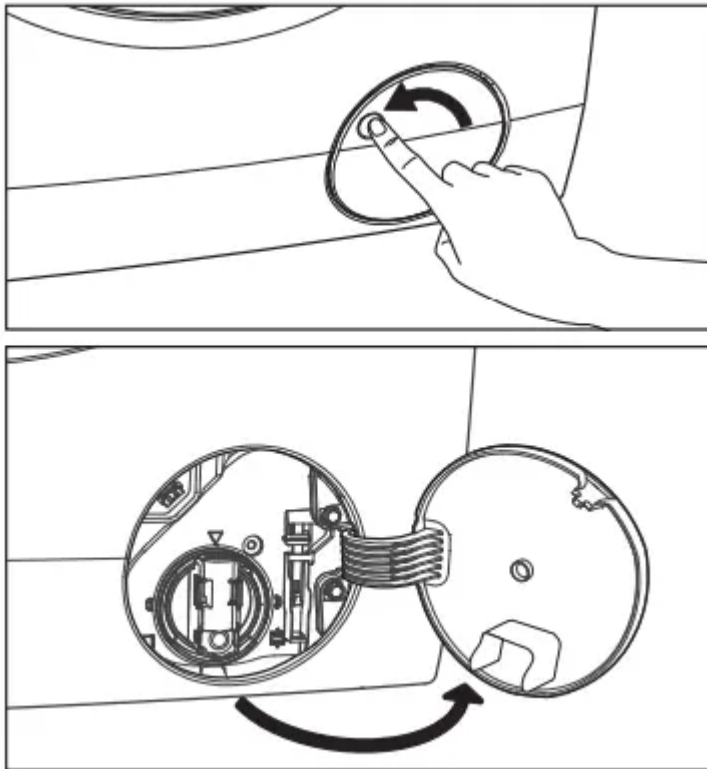

2. Place a suitable water container below the recess of the drain pump to collect the water that flows out. Press the two levers and pull forward the drainage duct to let the water

flow out.

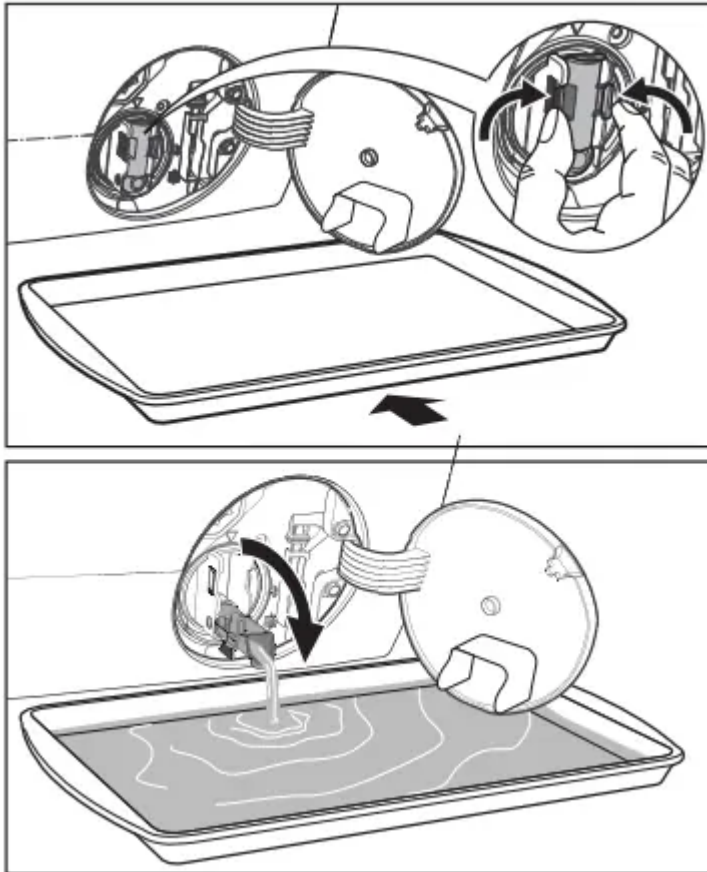

3. When the container is full of water, put the drainage duct back again and empty the container. Do step 2, 3 again and again until no more water flows out from the drain

pump.

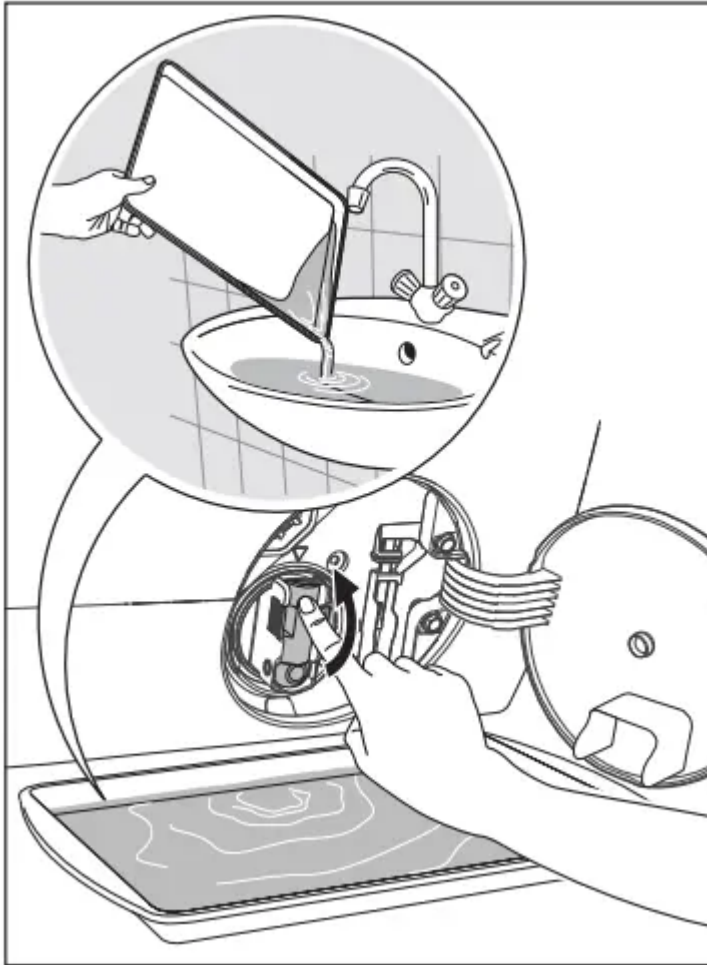

4. Push back the drainage duct and turn the filter counterr-clockwise to remove it.

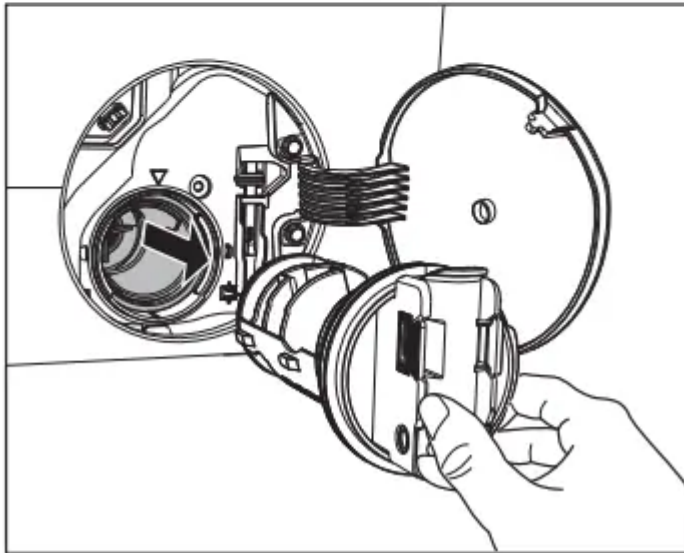
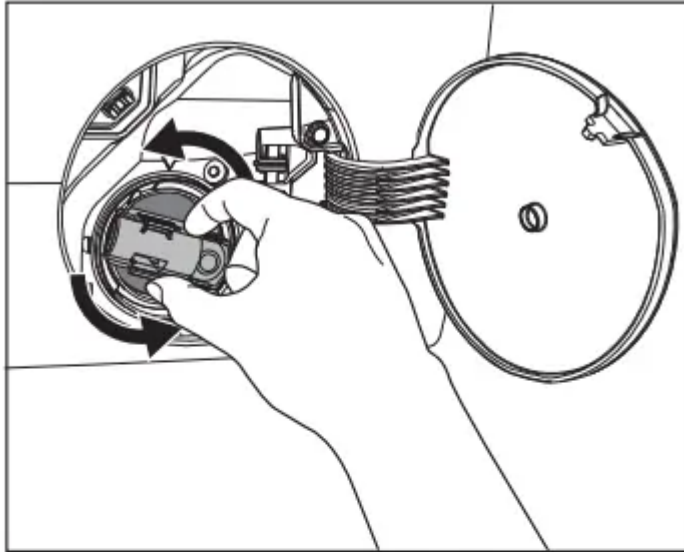

5. Remove fluff and objects from the pump (if there are any).

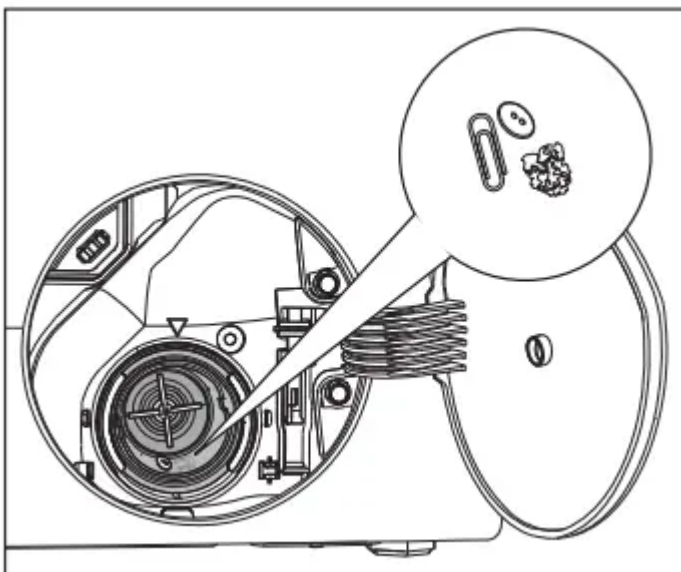

6. Make sure that the impeller of the pump can turn. If this does not occur, contact the service centre.

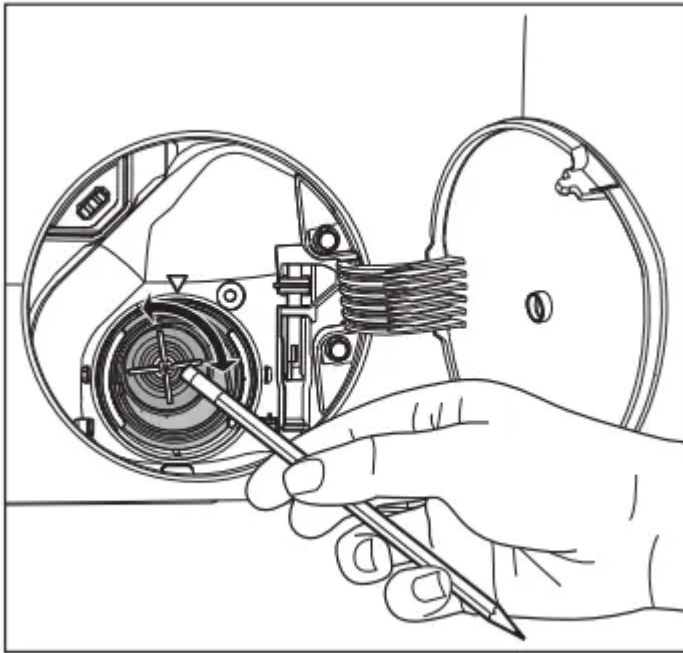

7. Clean the filter under the water tap.



- Put the filter back into the housing with exposed section facing up. Make sure that you correctly tighten the filter to prevent leakages.

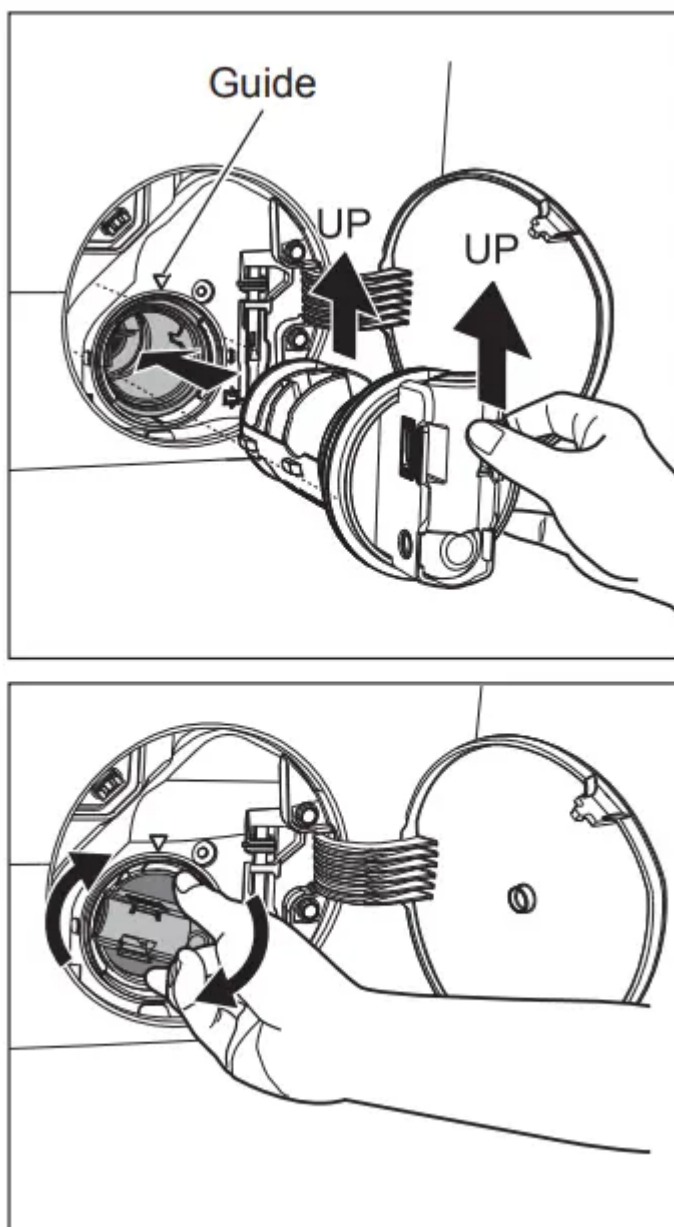

- Close the drain pump door.

Cleaning The Water Inlet Filter

If your water is very hard or contains traces of lime deposit, the water inlet filter may become clogged. It is therefore a good idea to clean it from time to time.

To clean the water inlet filters:

- Close the water tap.
- Remove the water inlet hose from the water tap.

3. Clean the filter in the inlet hose with a stiff brush.

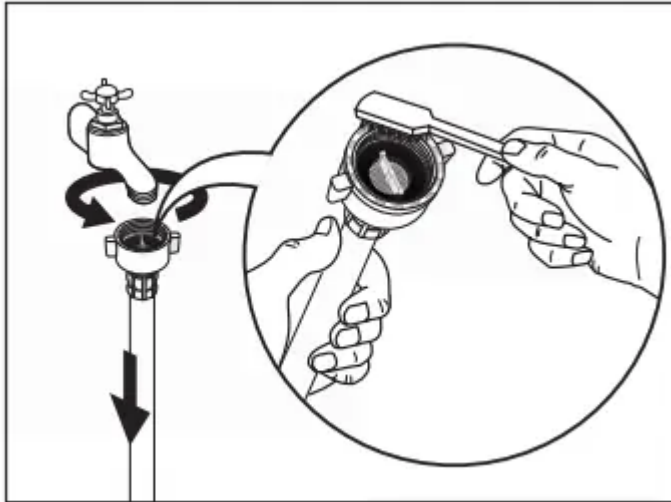

4. Remove the inlet hose behind the appliance.

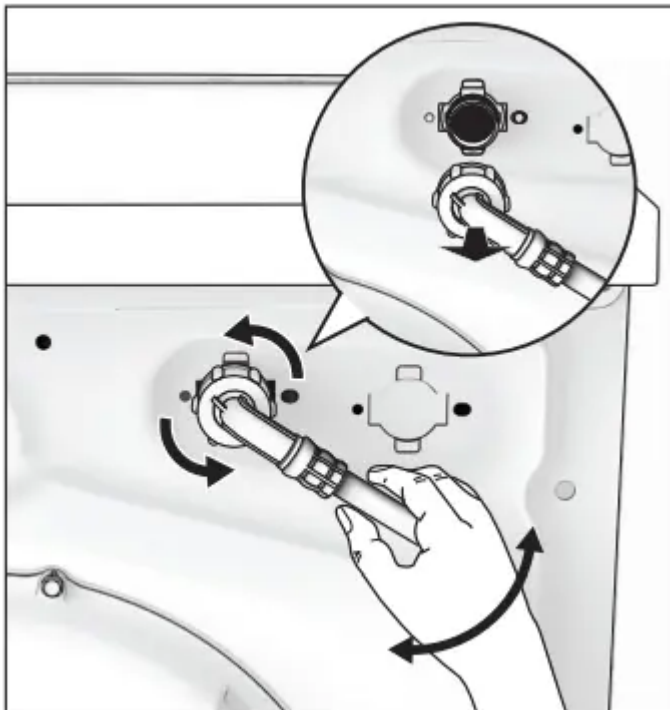

5. Clean the filter in the valve with a stiff brush or a towel.

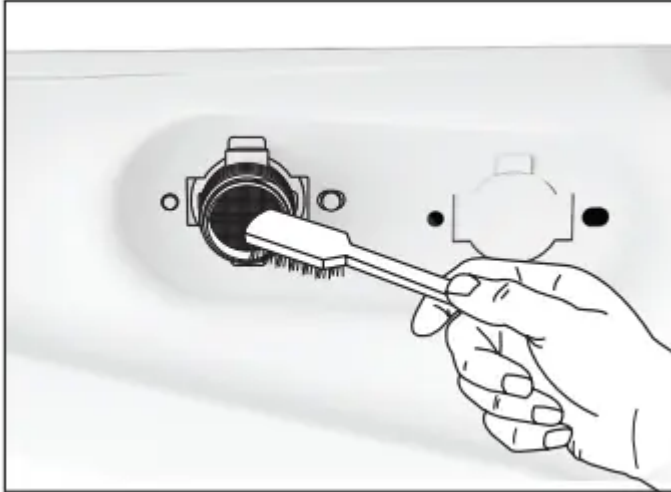

6. Install the inlet hose again. Make sure that the couplings are tight to prevent leakages.
7. Open the water tap.

Frost Precautions

If the appliance is installed in an area where the temperature can be less than 0 °C, remove the remaining water from the inlet hose and the drain pump.

Emergency Drain

1. Disconnect the main plug from the main socket. Turn off the water tap.
2. Remove the water inlet hose.
3. Remove the drain hose from the rear support and unhook it from sink or spigot.

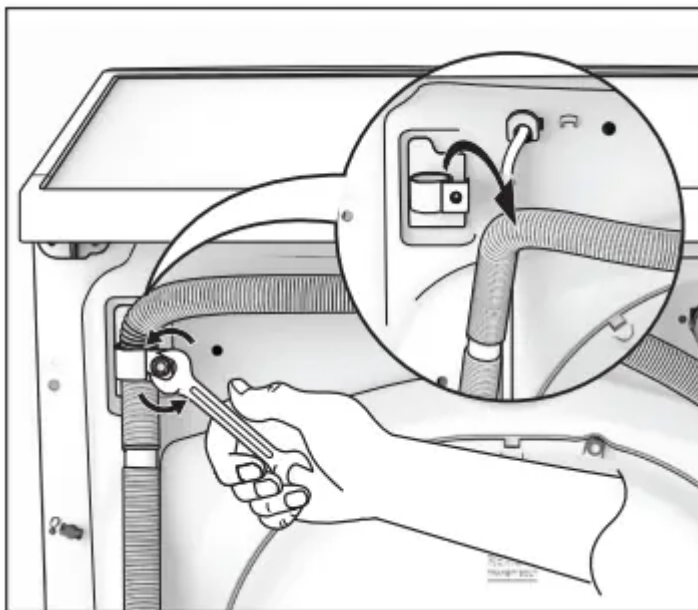

4. Put the end of the drain and inlet hose in a container. Let the water flow out of the hoses.

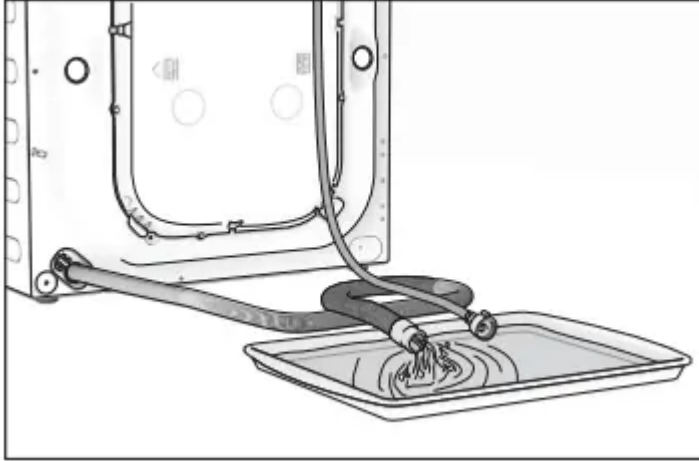

5. When no more water flows, install the inlet hose and the drain hose again.

NOTE Make sure that the temperature is more than 0 °C before you use the appliance again.

TROUBLESHOOTING

Possible Failures

Certain problems are due to lack of simple maintenance or oversights, which can be solved easily without calling out an engineer. Before contacting your local Service Centre, please check troubleshooting.

Once the problem has been eliminated, press the Start/Pause button to restart the program. If after all checks, the problem persists, contact your local Service Centre.

WARNING! Deactivate the appliance before you do the checks.

Alarm Code:

E10	The appliance does not fill with water properly.
E20	The appliance does not drain the water.
E40	The appliance door is open or not closed correctly. Please check the door!
E40	The main supply is unstable. Wait until the main supply is stable.
E91	No communication between electronic elements of the appliance. Switch off and switch on again.
E A0	No Registration Data found in machine or Server.

Malfunction	Possible cause	Solution
Machine does not start:	The door has not been closed. (Error code: E40)	Close the door firmly.
	The plug is not properly inserted into the power socket.	Insert the plug into the power socket.
	There is no power at the socket.	Please check your domestic electrical installation.
	The Start/Pause touchpad has not been pressed.	Press the Start/Pause touchpad.
	The “Delay Start” has been selected.	If the laundry are to be washed immediately, cancel the “Delay Start”.
	The Main supply is unstable. (If EH0 appears on the display.)	Wait until the main supply is stable. Appliance will start automatically.
Machine does not fill the water:	The water tap is closed. (Error code: E10)	Open the water tap.
	The inlet hose is squashed or kinked. (Error code: E10)	Check the inlet hose connection.
	The filter in the inlet hose is blocked. (Error code: E10)	Clean the water inlet hose filter.
	The door is not properly closed. (Error code: E40)	Close the door firmly.
Machine fills then empties immediately:	The end of the drain hose is too low. (Error code: E10)	Refer to relevant paragraph in “water drainage” section.

Machine does not empty and/or does not spin:	The drain hose is squashed or kinked. (Error code: E20)	Check the drain hose connection.
	The drain pump is clogged. (Error code: E20)	Clean the drain filter.
	The option "Rinse Hold" has been selected.	Press Start/Pause touchpad to drain the water or select spin program.
	The laundry is not evenly distributed in the drum.	Pause the machine and redistribute laundry manually.
There is water on the floor:	Too much detergent or unsuitable detergent (creates too much foam) has been used.	Reduce detergent quantity and use correct type of detergent (refer page 26).
	Check whether there are any leaks from one of the inlet hose fittings. It is not always easy to see this as the water runs down the hose; check to see if it is damp.	Check the water inlet hose connection.
	The drain hose is damaged.	Call Service.
Unsatisfactory washing results:	Too little detergent or unsuitable detergent has been used.	Increase detergent quantity or use different detergent (refer page 26).
	Stubborn stains have not been treated prior to washing.	Use commercial products to treat the stubborn stains.
	The correct temperature was not selected.	Check if you have selected the correct temperature.
	Excessive laundry load.	Reduce load.
The door will not open:	The program is still running.	Wait until the end of cycle.



	There is water in the drum.	You must drain the water to open the door (refer “Opening The Door” on page 21.
	This problem may be caused by a failure of the appliance.	Contact Service. If you need to open the door, please read carefully “Emergency door opening” on page 38
Machine vibrates or is noisy:	The transit bolts and packing have not been removed.	Check the correct installation of the appliance.
	The support feet have not been adjusted.	Check the correct levelling of the appliance.
	The laundry is not evenly distributed in the drum.	Pause the machine and redistribute laundry manually.
	There is very little laundry in the drum.	Load more laundry.
	Unstable floors eg. wooden floors.	Refer to relevant paragraph in “Positioning” section.
Cycle time longer than displayed:	Detergent over dose.	Reduce the detergent quantity or use another one. (Refer page 26 “Detergents Type And Quantity Of Detergent”).
	Machine unbalance.	Redistribute laundry manually in the drum and start the spin phase again.
The cycle is shorter than the time displayed.	The appliance calculated a new time according to the laundry load.	

<p>Spinning starts late or machine does not spin:</p>	<p>The electronic unbalance detection device has cut in because the laundry is not evenly distributed in the drum. The laundry is redistributed by reverse rotation of the drum.</p> <p>This may happen several times before the unbalance disappears and normal spinning can resume. If, after 10 minutes, the laundry is still not evenly distributed in the drum, the machine will not spin. In this case, redistribute the load manually and select the spin program.</p>	<p>Pause the machine and redistribute laundry manually.</p>
<p>Machine makes an unusual noise:</p>	<p>Machine not installed properly.</p>	<p>Make sure the levelling of the appliance is correct. Refer to "Installation".</p>
	<p>Transit bolts or packaging not removed.</p>	<p>Make sure that the packaging and/or the transit bolts are removed. Refer to "Unpacking".</p>
	<p>The load may be too small.</p>	<p>Add more laundry in the drum.</p>
<p>No water is visible in the drum:</p>	<p>Machines based on modern technology operate very economically using very little water without affecting performance.</p>	
<p>Machine does not dry or does not dry properly:</p>	<p>The "Time Dry" or the "Dryness Level" degree has not been selected.</p>	<p>Select the drying time or the dryness level degree.</p>

	The water tap is not turned on. (Error code: E10)	Open the water tap.
	The drain filter is clogged. (Error code: E20)	Clean the drain filter.
	The machine is overloaded.	Reduce the laundry load in the drum.
	The selected drying program, time or dryness level was not suitable for the laundry.	Select the suitable drying program, time or dryness level for the laundry.
Display time is frozen at the end of drying cycle for more than 30 minutes:	Machine is optimizing the drying cycle according to the laundry type and load size. It will vary for each kind of fabric as the water absorption is different.	This is a normal behavior of the machine and not a cause for concern as it does not compromise its performance.
Remote function does not work:	Registration Data lost or damaged. (Error Code: EA0)	Restart machine by turn Off and turn On again. If problem not solved, please contact Service Centre.

NOTE

If you are unable to identify or solve the problem, contact our service centre. Before calling service centre, make a note of the model, serial number and purchase date of your machine: the Service Centre will require this information.

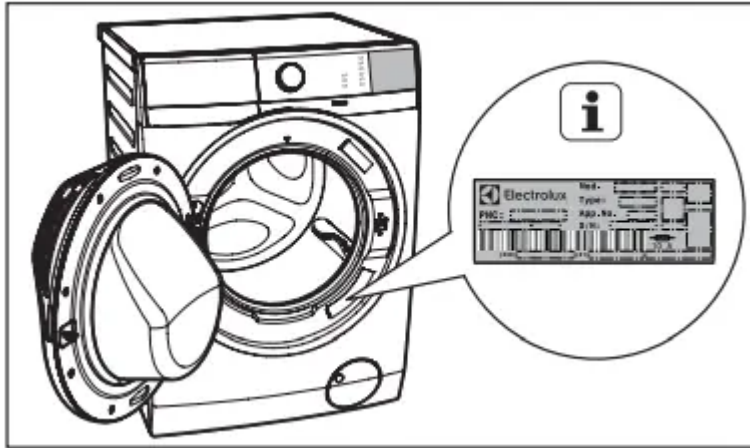

Emergency Door Opening

In case of power failure or appliance failure, the appliance door remains locked. The wash program continues when power is restored. If the door remains locked in case of failure, it is possible to open it using the emergency unlock feature.

Before opening the door:

WARNING

Make sure that the water temperature and the laundry are not hot. Wait until they cool down if necessary.

Make sure that the water level inside the drum is not too high. If necessary, perform an Emergency Drain (see page 32).

Make sure that the drum is not rotating. Wait until the drum stops rotating if necessary.

To open the door proceed as follows:

1. Press the On/Off button to switch the appliance off.
2. Disconnect the mains plug from the mains socket.
3. Open the filter cover.
4. Without touching the door. Insert a small flathead screw driver into the slot on emergency unlock strap (red strap) and pull down twice then pull the door open.

Repeat if unsuccessful.

Note: Do not pull down emergency strap too hard.

5. Take out the laundry.
6. Close the filter flap.

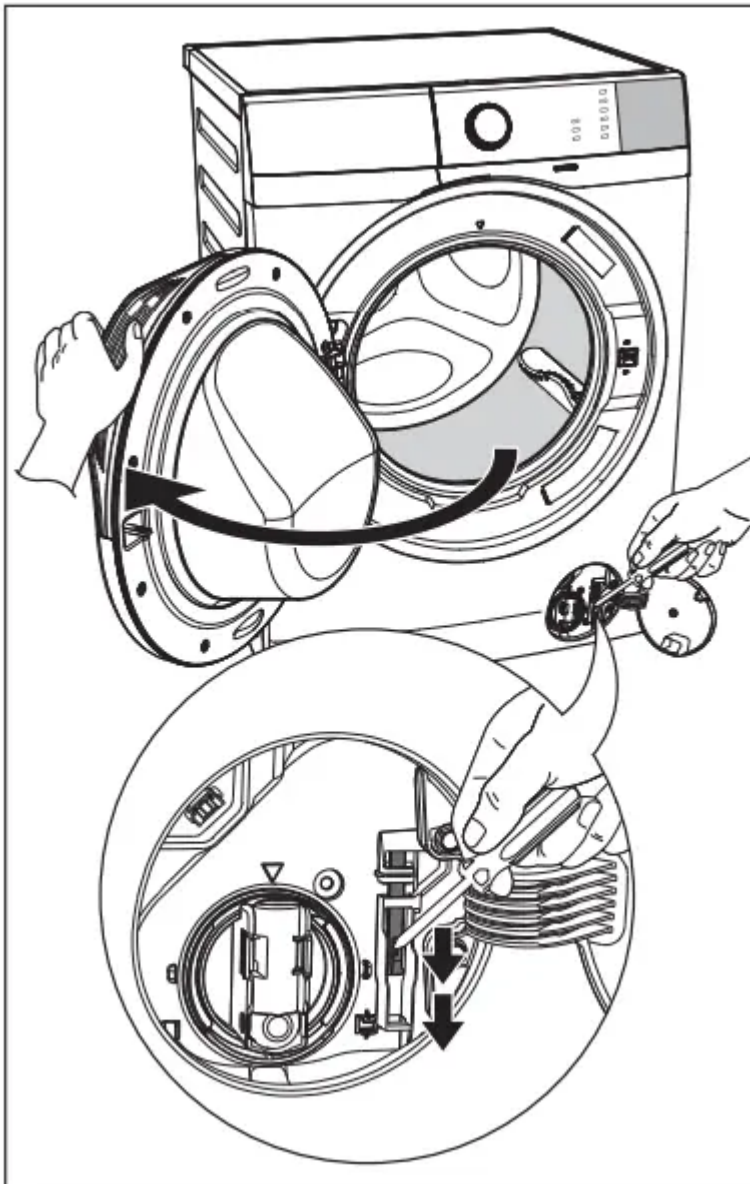

Warning

This content is compiled from multiple sources and is provided for reference purposes only. It may not be complete or fully applicable to all situations. If you are unable to resolve your issue, please contact the product manufacturer or an authorized service provider for official support.

