

Quick start

Power modes

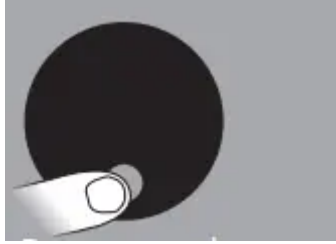

Your appliance has three power modes for different tasks. Change cleaning modes quickly using a single button.

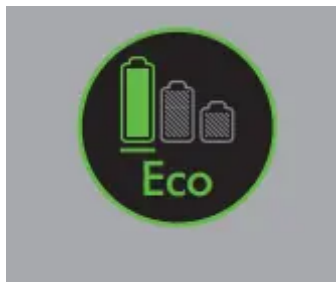

Maximum run time, for longer cleans.

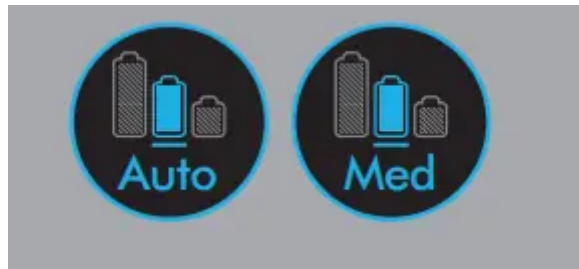

The optimum balance to clean all floors. Attach your High torque cleaner head to activate Auto/ Med mode, which automatically adapts power between carpets and hard floors.

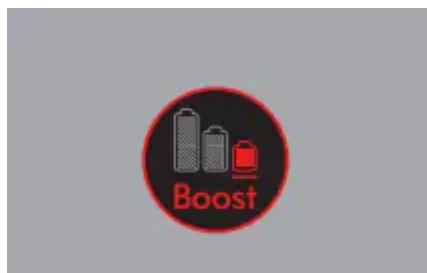

Intensive cleaning for ground-in dirt.

Charging

Your appliance will need to be fully charged before first use.

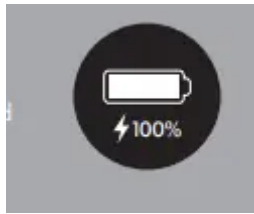

Registration

- After registering your free 2 year warranty, your Dyson appliance will be covered for parts and labour (excluding filters) for 2 years from the date of purchase, subject to the terms of the warranty.
- If you have any queries regarding your Dyson appliance, visit for online help, support videos, general tips and useful information about Dyson
- Alternatively, you can call the Dyson Helpline with your serial number and details of where and when you bought the appliance.
- Your serial number can be found on your rating plate which is on the base of the appliance.

IMPORTANT SAFETY INSTRUCTIONS

TO REDUCE THE RISK OF FIRE, ELECTRIC SHOCK, OR INJURY:

1. This appliance is not intended for use by persons (including children) with reduced physical, sensory or mental capabilities, or lack of experience and knowledge, unless they have been given supervision or instruction concerning use of the appliance by a person responsible for their safety.
2. Do not allow to be used as a toy. Close attention is necessary when used by or near children. Children should be supervised to ensure that they do not play with the appliance.
3. Use only as described in this Dyson Operating Manual. Do not carry out any maintenance other than that shown in this manual, or advised by the Dyson Helpline.
4. Suitable for dry locations ONLY. Do not use outdoors or on wet surfaces.
5. Do not handle any part of the charger or appliance with wet hands.
6. Do not use with a damaged charger or cord.
7. If the appliance is not working as it should, if it has received a sharp blow, if it has been dropped, damaged, left outdoors, or dropped into water, do not use and contact the Dyson Helpline.
8. Contact the Dyson Helpline when a service or repair is required. Do not disassemble the appliance as incorrect reassembly may result in an electric shock or fire.
9. Do not stretch the cord or place the cord under strain. Keep the cord away from heated surfaces. Do not close a door on the cord, or pull the cord around sharp edges or corners. Arrange

the cord away from traffic areas and where it will not be stepped on or tripped over. Do not run over the cord. Do not unplug the charger by pulling on the cord. To unplug, grasp the charger, not the cord.

10. Do not use to pick up water.

11. Do not use to pick up flammable or combustible liquids, such as gasoline, or use in areas where they or their vapours may be present.

12. Do not pick up anything that is burning or smoking, such as cigarettes, matches, or hot ashes.

13. Keep hair, loose clothing, fingers, and all parts of the body away from openings and moving parts. Do not point the hose, wand or tools at your eyes or ears or put them in your mouth.

14. Do not put any object into openings. Do not use with any opening blocked; keep free of dust, lint, hair, and anything that may reduce airflow.

15. Use only Dyson recommended accessories and replacement parts.

16. Do not use without the clear bin and filter(s) in place.

17. Unplug the charger when not in use for extended periods.

18. Use extra care when cleaning on stairs.

19. To prevent unintentional starting, be careful to keep your hands and fingers away from the 'ON' trigger until you are ready to begin vacuuming, especially when picking up or carrying the appliance. Carrying the appliance with your finger on the 'ON' trigger invites accidents.

20. Do not install, charge or use this appliance outdoors, in a bathroom or within 3 metres (10 feet) of a pool. Do not use on wet surfaces and do not expose to moisture, rain or snow.

21. Use only the Dyson charger Part Number 217160 for charging this Dyson appliance. Use only Dyson batteries: other types of batteries may explode, causing injury to persons and damage.

22. When removing or replacing a motorized brush bar, be careful not to pull the 'ON' trigger until the cleaner head has been reassembled.

23. Do not use a battery pack or appliance that is damaged or modified. Damaged or modified batteries may exhibit unpredictable behaviour resulting in fire, explosion or risk of injury. Do not expose battery pack or appliance to fire or excessive temperatures. Exposure to fire or temperatures above 60°C (140°F) may cause explosion.

24. The battery is a sealed unit and under normal circumstances poses no safety concerns. In the unlikely event that liquid leaks from the battery, do not touch the liquid as it may cause irritation or burns, and observe the following precautions:

- Skin contact – can cause irritation. Wash with soap and water.
- Inhalation – can cause respiratory irritation. Expose to fresh air and seek medical advice.
- Eye contact – can cause irritation. Immediately flush eyes thoroughly with water for at least 15 minutes. Seek medical attention.

- Disposal – wear gloves to handle the battery and dispose of immediately, following local ordinances or regulations

25. Follow all charging instructions and do not charge the battery pack or the appliance outside of the temperature range specified in the instructions. Charging improperly or at a temperature outside of the specified range may damage the battery and increase the risk of fire. To ensure maximum battery life, Dyson recommends the following:

- When not in use the appliance should be stored at room temperature. Recommended range: 18°C (64°F) to 28°C (82°F).
- The ambient temperature range for operation and charging should be 10°C (50°F) to 30°C (86°F)

26. FIRE WARNING – Do not place this product on or near a cooker or any other hot surface and do not incinerate this appliance even if it is severely damaged. The battery might catch fire or explode.

27. FIRE WARNING – Do not apply any fragrance or scented product to the filter(s) of this appliance. The chemicals in such products are known to be flammable and can cause the appliance to catch fire.

Display Affichage

Selection button



You can control the settings on your appliance using the selection button.

Language selection



Press and hold the selection button for 5 to 10 seconds to view the language list.



Press the selection button to scroll through the languages. A short (between 2 and 4 seconds) hold press on the selection button selects a language.



If the wrong language is selected then a short hold press on the selection button when the cross is displayed will return you to the language list.



To confirm the language press the selection button to scroll to the tick, then a short hold press on the selection button will confirm your selection.

Low battery



The screen will alert you when your battery is getting low.



A final alert is shown when your battery is empty and needs to be charged.

Alerts



The screen will alert you when your appliance needs your attention. Follow the instructions on screen to maintain performance.

Battery health



Continued or regular use of Eco or Auto/Med mode helps to maximize cleaning time and prevents overheating, preserving battery durability and life.

Emptying the clear bin

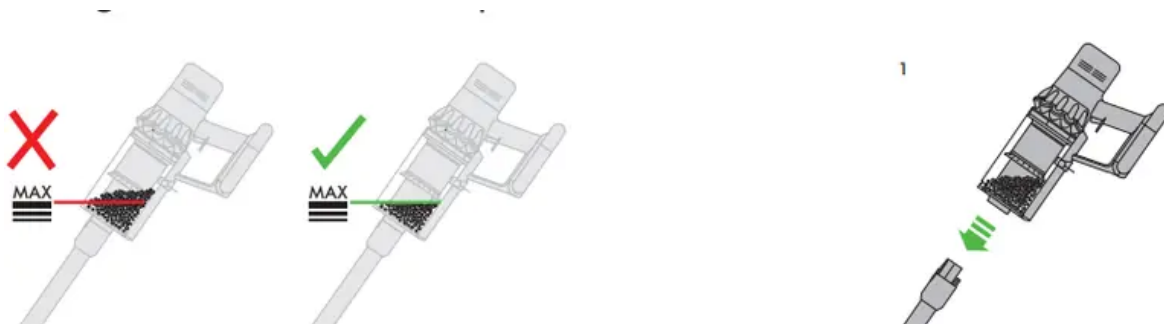

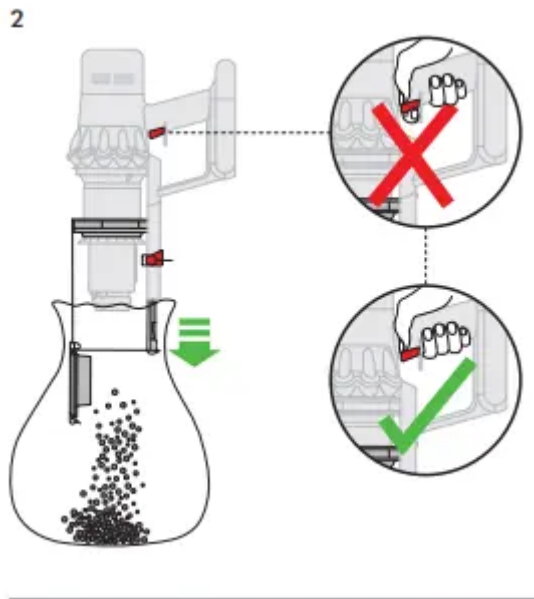

Be careful not to pull the 'ON' trigger while the clear bin is open for emptying.

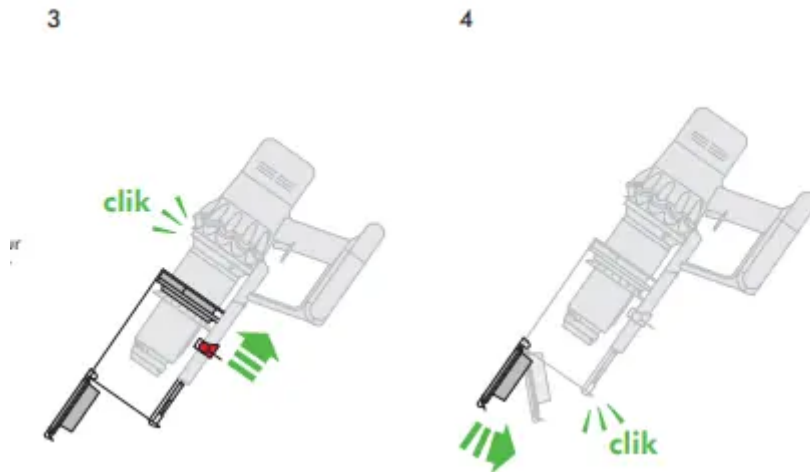

Close the clear bin by pushing the bin base upwards until the clear bin and bin base click into place.

Charging Chargement

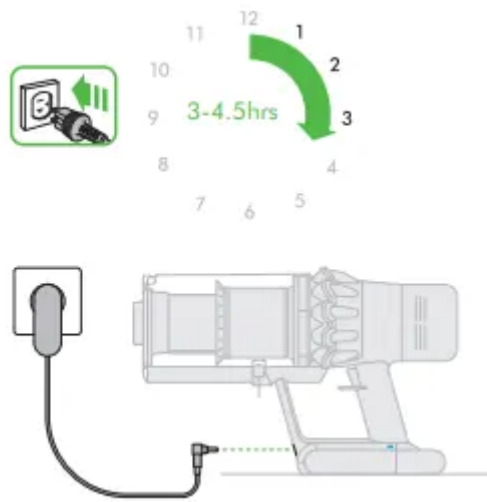

Connect to charger either directly or in the docking station. The blue LEDs – one on each side of the battery – will flash on and off during charging. When the battery is charged, both LEDs will light for 5 seconds, then go out

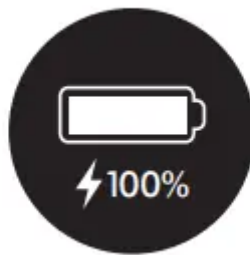

Battery is charged when display shows battery at 100%.

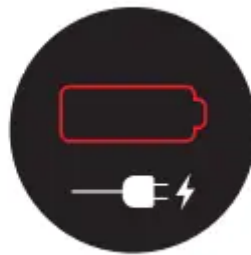

Battery empty and needs charging.

Looking for blockages

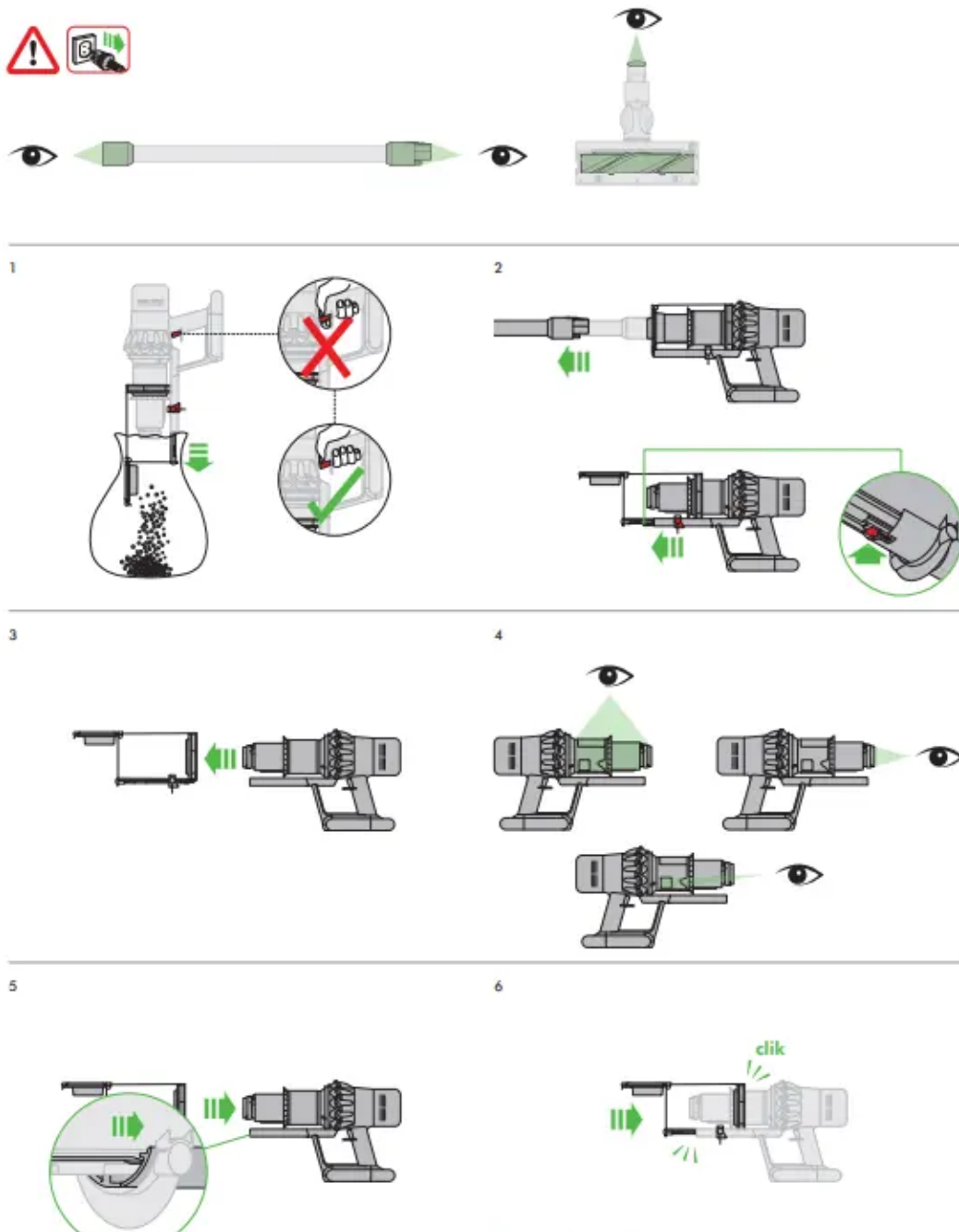

Close the clear bin by pushing the bin base upwards until the clear bin and bin base click into place.

Cleaning the filter

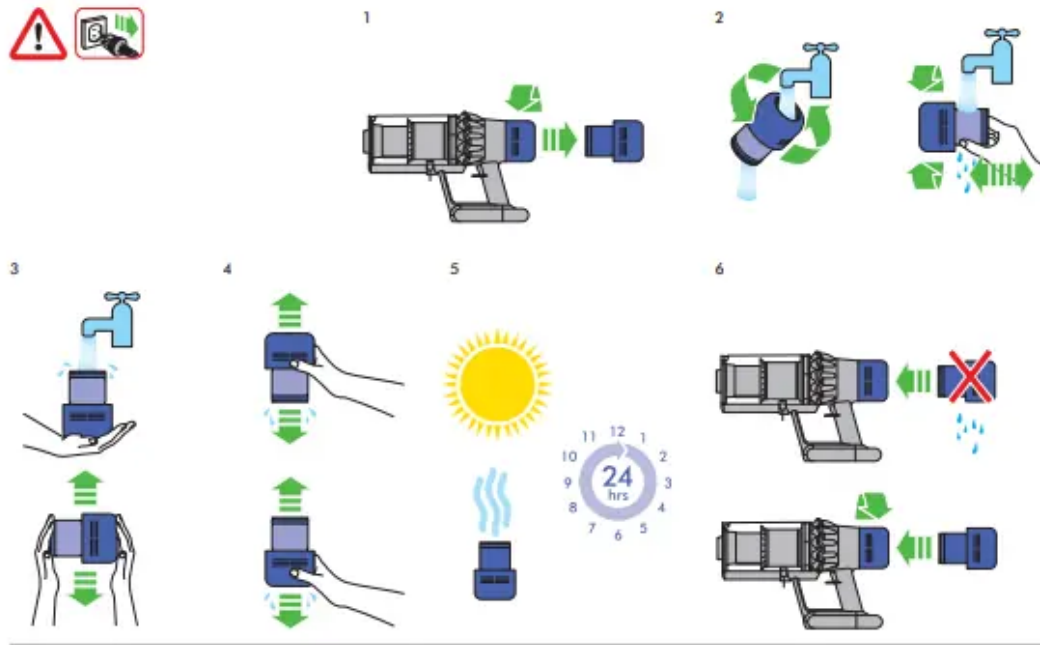

High torque cleaner head maintenance

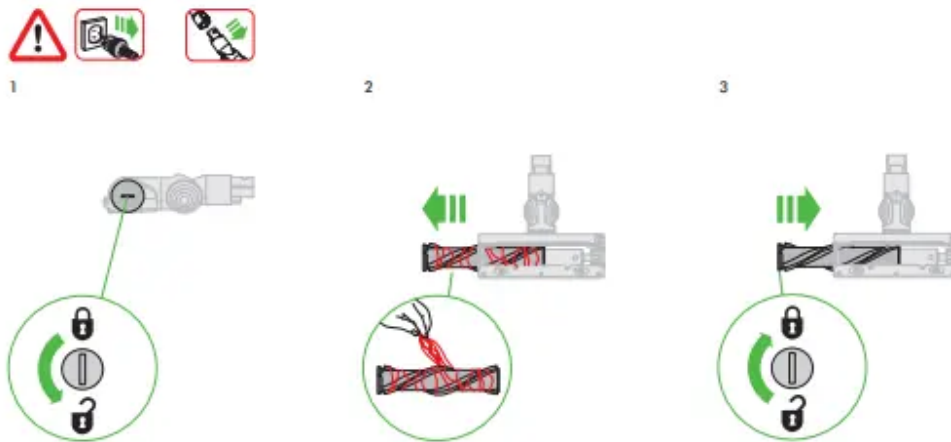

Additional information

Docking station installation

- Unpack the docking station, charger and installation leaflet.
- Select the location for the docking station and ensure that there is no pipework (gas, water or air), electrical cables, wires or ductwork directly behind the mounting location.
- Follow the instructions on the installation leaflet.

- Click the attachments into place.
- Place the appliance in the docking station.
- Plug the charger into the mains electricity supply. Switch on (if necessary) to charge the battery.

Your appliance will need to be fully charged before first use. Dyson recommends the use of protective clothing, eyewear and materials when installing the docking station.

Vacuuming

- Remove the appliance from the docking station.
- Check that the underside of the cleaner head or tool is clean and free from foreign objects that may cause damage.

Before vacuuming your flooring, rugs and carpets, check the manufacturer's recommended cleaning instructions.

The brush bar on the appliance can damage certain carpet types and floors. Some carpets will fuzz if a rotating brush bar is used when vacuuming. If this happens, we recommend vacuuming without the motorized floor tool and consulting with your flooring manufacturer.

High torque cleaner head – suction control slider

Your High torque cleaner head has a slider control to adjust the suction of the cleaner head.

To select the suction required, move the suction control slider on top of the cleaner head.

Maximum suction for ground in dust and debris (+)

- For vacuuming durable floor coverings, hard floors and heavily soiled carpets and rugs.

Suction for dust and debris (▲)

- For vacuuming of lightly soiled carpets, rugs and hard flooring.
- For vacuuming of large debris such as peanuts or rice.

Suction for deep pile carpets and delicate flooring (-)

- For vacuuming deep pile carpets or rugs and any flooring on which you may experience greater resistance.
- For vacuuming of lightly soiled floors, including delicate flooring such as vinyl, parquet and lino.

Emptying the clear bin

- Empty as soon as the dirt reaches the level of the MAX mark – do not overfill.
- Be careful not to pull the 'ON' trigger while the clear bin is open for emptying.
- Remove the wand by pressing the red wand release button and pulling away from the bin.

To release the dirt:

- Hold the appliance with the bin in a downwards position.
- Firmly push the red bin release button.
- The bin will slide down, cleaning the shroud as it goes.
- The bin base will then open.
- The bin base will not open if the red button is not pushed down fully.

To minimize dust/allergen contact when emptying, encase the clear bin tightly in a dust proof bag and empty. Remove the clear bin carefully from the bag. Seal the bag tightly, dispose as normal.

Cleaning the clear bin (optional)

If it is necessary to clean the clear bin:

- Follow the instructions in the 'Emptying the clear bin' section.
- Press the red button located on the bin runner to release the bin and slide the bin off the runner.
- Clean the clear bin with a damp cloth only.
- Ensure that the clear bin and seals are completely dry before replacing.
- To refit the clear bin:
 - Insert the spine on to the bin runner.
 - Close the clear bin by pushing the bin base upwards until the clear bin and bin base click into place.

The clear bin is not dishwasher safe and the use of detergents, polishes or air fresheners to clean the clear bin is not recommended as this may damage your appliance.

Filter and blockage indicators

The display of your appliance will alert you when simple maintenance steps are needed.

- The filter indicator will show when the filter unit is not fitted correctly. Follow the instructions on how to refit the filter unit in the 'Washing the filter unit' section.
- The filter indicator will show when the filter unit needs washing. Follow the instructions on how to wash the filter unit in the 'Washing the filter unit' section.
- The blockage indicator will show if there is a blockage. Follow the instructions on how to clear blockages in the 'Looking for blockages' section.

Washing the filter unit

Wash the filter unit at least once every month, or whenever the filter maintenance indicator lights.

Check and wash the filter unit, according to the instructions, to maintain performance.

- Remove the filter unit by twisting it counterclockwise. Gently pull away from the appliance.
- Gently tap the filter unit to remove any excess dust and debris before washing it.
- Wash the filter unit in cold water only: do not use detergent, or wash it in a dishwasher or washing machine.
- Wash the pleated paper element of the filter unit first; hold the filter unit under a cold water tap with the foam element downwards and run cold water over the pleated paper.
- Continue washing until the water runs clear.
- Wash the foam element of the filter unit next; hold the filter unit under a cold water tap with the foam element downwards so that dirty water does not contaminate the pleated paper element. Run cold water over the inside and outside of the foam element and squeeze the foam gently to expel the dirt.
- Continue washing until the water runs clear.
- Wash the outside of the filter unit. Then fill the unit with cold water, place your hands over the open ends and shake gently.
- Repeat washing the elements and outside of the filter unit until the water runs clear.
- Gently shake the filter unit to remove any excess water and leave to drain with the foam element end facing up.
- Leave the filter unit to dry completely in a dry environment with good airflow, for a minimum of 24 hours.
- Check that the filter unit is completely dry.
- To refit, return the filter unit to the main body and twist clockwise until it clicks into place.

The filter unit may require more frequent washing if vacuuming fine dust or if use is mainly in Boost mode. Do not put any part of your appliance in a dishwasher, washing machine, tumble dryer, oven, microwave or near a naked flame.

High torque cleaner head

- The brush bar of a motorized cleaner head is not washable.

Quick-release mini motorhead tool

- The brush bar of a motorized cleaner head is not washable.

Blockages – automatic cut-out

- This appliance is fitted with an automatic cut-out.
- If any part becomes blocked, the appliance may automatically cut out.
- This will happen after the motor pulses a number of times (i.e switches on and off in quick succession) and the blockage indicator will light.

- Leave to cool down before looking for blockages.
- Be careful not to pull the 'ON' trigger while looking for blockages. Operating the appliance while it is partially dismantled could result in personal injury.
- Clear any blockages before restarting.
- Refit all parts securely before using.
- Clearing blockages is not covered by your warranty.

Looking for blockages

The motor will pulse and the blockage indicator will show when there is a blockage. Please follow the instructions below to locate the blockage:

- Be careful not to pull the 'ON' trigger while looking for blockages. Operating the appliance while it is partially dismantled could result in personal injury.
- Beware of sharp objects when checking for blockages.
- To check for blockages in the main body of the appliance, remove the clear bin following the instructions in the 'Emptying the clear bin' section and remove the blockage.
- If you cannot clear an obstruction from the cleaner head, you may need to remove the brush bar. Use a coin to unlock the fastener, slide the brush bar out of the cleaner head and remove the obstruction. Replace the brush bar and secure it by tightening the fastener. Ensure it is fixed firmly before operating the appliance.
- This appliance has carbon fibre brushes. Take care if coming into contact with them, as they may cause minor skin irritation. Wash your hands after handling the brushes.
- Refit all parts securely before using.
- Clearing blockages is not covered by your warranty.

Charging and storing

- This appliance will switch 'OFF' if the battery temperature is below 10°C (50°F). This is designed to protect the motor and battery. Do not charge the appliance and then move it to an area with a temperature below 10°C (50°F) for storage purposes.
- To help prolong battery life, avoid recharging immediately after a full discharge. Allow to cool for a few minutes.
- Avoid using the appliance with the battery flush to a surface. This will help it run cooler and prolong battery run time and life.

Battery safety instructions

- If the battery needs replacing please contact the Dyson Helpline.
- Use only the Dyson charger Part Number 217160 for charging this Dyson appliance.

CAUTION

- The battery used in this device may present a risk of fire or chemical burn if mistreated. Do not short contacts, heat above 60°C (140°F), or incinerate. Keep away from children. Do not disassemble and do not dispose of in fire.

Disposal information

- Dyson products are made from high grade recyclable materials. Recycle where possible.
- The battery should be removed from the product before disposal.
- Dispose of the battery in accordance with local ordinances or regulations.
- Dispose of the exhausted filter unit in accordance with local ordinances or regulations.

Dyson Customer Care

- Thank you for choosing to buy a Dyson appliance
- After registering your 2 year warranty, your Dyson appliance will be covered for parts and labour for 2 years (excluding filters) from the date of purchase, subject to the terms of the warranty. If you have any queries regarding your Dyson appliance, visit www.dysoncanada.ca for online help, general tips and useful information about Dyson.
- Alternatively, you can call the Dyson Helpline with your serial number and details of where and when you bought the appliance.
- If your Dyson appliance needs a repair, call the Dyson Helpline so we can discuss the available options. If your Dyson appliance is under warranty, and the repair is covered, it will be repaired at no cost.
- Any maintenance other than that shown in this manual or advised by the Dyson Helpline, particularly the replacement of non-user-serviceable parts, should be performed by an authorized Dyson service representative.

Please register as a Dyson appliance owner

To help us ensure that you receive a prompt and efficient service, please register as a Dyson appliance owner. There are three ways to do this:

- Telephone the Dyson Helpline on 1-877-397-6622
- Complete the enclosed Warranty Form and mail it to us. This will confirm ownership of your Dyson appliance in the event of an insurance loss, and enable us to contact you if necessary

What is covered

- Your Dyson appliance is warranted against original defects in materials and workmanship for a period of 2 years from the date of purchase, when used for normal domestic purposes in accordance with the Dyson Operating Manual. Please retain your proof of purchase. If you do not have your proof of purchase, your warranty will start 90 days after the date of manufacture, according to Dyson's records. This warranty provides, at no extra cost to you,

all labour and parts necessary to ensure that your appliance is in proper operating condition during the warranty period. The replacement of any part of your appliance under warranty will not extend the period of warranty. Any parts which are returned to Dyson will become the property of Dyson. Please call the Dyson Helpline on 1-877-397-6622 for more information.

- This limited warranty is subject to the following terms:

What is not covered

Dyson Canada Limited shall not be liable for costs, damages or repairs incurred as a result of, due to, or from:

- Purchases of appliances from unauthorized dealers.
- Careless operation or handling, misuse, abuse and/or lack of maintenance or use not in accordance with the Dyson Operating Manual.
- Use of the appliance other than for normal domestic purposes within Canada, e.g. for commercial or rental purposes.
- Use of parts not in accordance with the Dyson Operating Manual.
- Use of parts and accessories other than those produced or recommended by Dyson.
- External sources such as weather, electrical outages or power surges.
- Repairs or alterations carried out by unauthorized parties or agents.
- Clearing blockages from your appliance or washing of the filter.
- Normal wear and tear, including normal wearing parts, such as the clear bin, filter, tools and power cord (or where external damage or abuse is diagnosed), carpet or floor damage due to use not in accordance with the Dyson Operating Manual.
- Reduction in battery discharge time due to battery age or use (where applicable).
- Damage as a result of use not in accordance with the rating plate. Use of this appliance on rubble, ash, plaster, drywall, liquids, or wet surfaces.
- Additionally, this limited warranty does not apply to any appliance that has had the serial number altered or removed.

Warranty limitations and exclusions

- Any implied warranties relating to your appliance including but not limited to warranty of merchantability or warranty of fitness for a particular purpose, are limited to the duration of this warranty. This limitation is not allowed by some Provinces and/or Territories and so this limitation may not apply to you.
- Your remedy for breach of this warranty is limited to the warranty service described above
- Dyson Canada Limited will not be liable for any consequential damages or incidental damages you may incur in connection with the purchase and use of your appliance.

- This limited warranty gives you specific legal rights. You may also have other rights which vary by Province and/or Territory.
- This limited warranty is not transferable
- This limited warranty is only available in Canada.

Warranty service

- Please fill out and return the Warranty Form, or register online
- Before a service can take place, the terms of the warranty require that you contact the Dyson Helpline with your model name/number, serial number, date and place of purchase.
- Please keep your purchase receipt in a safe place to ensure that you have this information.
- All work will be coordinated by Dyson Canada Limited or its authorized agents.
- replaced defective parts will become the property of Dyson.
- Service under this warranty will not extend the period of this warranty.
- If your appliance is not functioning properly, please call the Dyson Helpline on 1-877-397- 6622. Most issues can be rectified over the telephone by our trained Dyson Helpline staff.

Important data protection information

- You will need to provide us with basic contact information when you register your Dyson Product or the Dyson Link app;

When registering your Dyson appliance:

You will need to provide us with basic contact information to register your product and enable us to support your warranty.

- When you register, you will have the opportunity to choose whether you would like to receive communications from us. If you opt-in to communications from Dyson, we will send you details of special offers and news of our latest innovations.
- We never sell your information to third parties and only use information that you share with us as defined by our privacy policies which are available on our website at privacy.dyson.com

Warning

This content is compiled from multiple sources and is provided for reference purposes only. It may not be complete or fully applicable to all situations. If you are unable to resolve your issue, please contact the product manufacturer or an authorized service provider for official support.

