

WASHING MACHINE DESCRIPTION

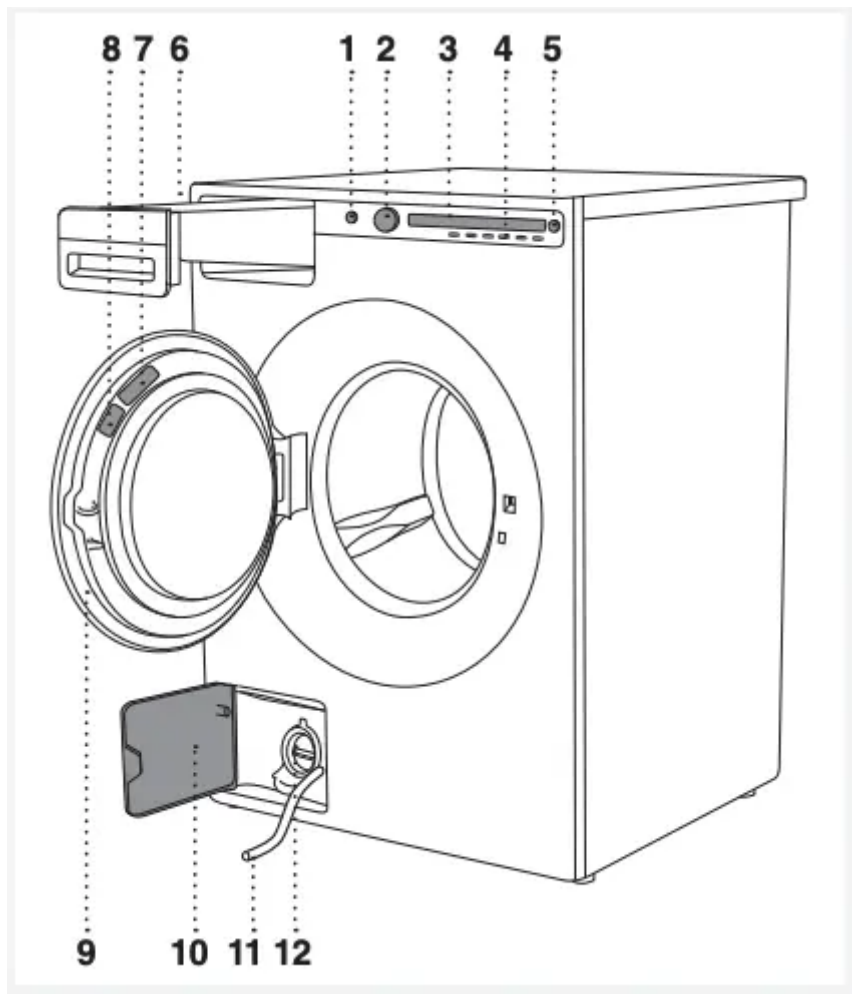

1. Main switch (ON/OFF)
2. Program selector knob
3. Display unit
4. Program settings buttons
5. Button (start/pause/stop)
6. Dispenser tray
7. Rating plate with information about the washing machine (on the inside of the washing machine door)
8. QR and AUID code (on the inside of the washing machine door)
9. Washing machine door
10. Drain filter cover

11. Water release hose

12. Drain filter pump (installed behind the drain pump filter)

DISPENSER TRAY

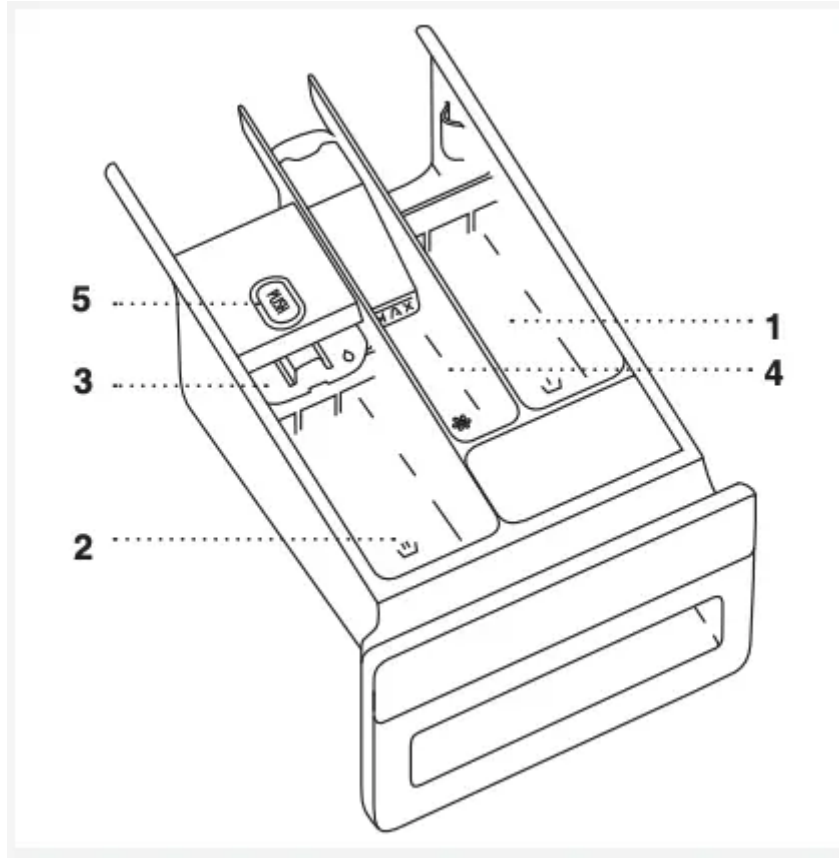

1. Prewash compartment



2. Compartment for main wash liquid detergent. Use the barrier (3).



3. Compartment for main wash powder detergent. Do not use the barrier (3).



4. Softener / conditioner compartment



5. Tab for dispenser tray removal

BEFORE USING THE APPLIANCE FOR THE FIRST TIME

PACKAGING

Remove all packaging.

Please sort the materials in compliance with local recommendations (see chapter "DISPOSAL").

TRANSPORT PROTECTION

Before using the appliance, remove the three transport bolts and plastic plugs which protect the appliance during transport.

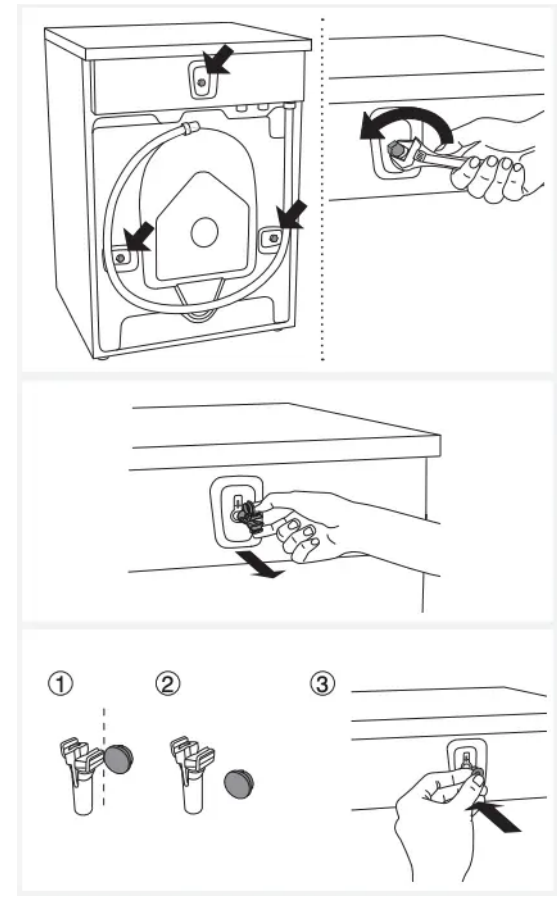

1. Release and remove the bolts as shown in the figures.
2. To remove the plastic plugs holding the bolts, squeeze them and then pull them out.
3. Remove the caps from the plastic plugs. Push the caps over the three holes in which the plastic plugs were inserted. Save the plastic plugs if you have to transport your washing machine in the future.



If you wish to transport the washing machine, reinstall the bolts and plastic caps to lock the machine. This will prevent any damage to the machine due to vibrations during transport. If you have lost the transport bolts or plastic caps, replacements can be ordered at your dealer.

Art. No.	ID:
270698	Bolt
551188	Plastic cap (transport lock)

Please order three pieces of each item!

CLEANING

Disconnect the washing machine from the power mains and open the door. Clean the washing machine drum with a damp cloth and a mild detergent.



No program can be started while the door is open.

SETTINGS BEFORE FIRST USE

After connecting the washing machine and running it for the first time, choose the following:

Language selection

Press the button 2 or the program selector knob to scroll the list of languages. Confirm your selection by pressing the OK button.



The amount of detergent depends on the hardness of water. For details, see the detergent packaging. Please contact your local water supply company to check the water hardness in your area.



Before it dispatched from the factory, every appliance is tested. As a result, there may be some residual water left in the drain pump filter. This, however, does not affect the quality and will not damage the appliance.

TIPS BEFORE WASHING

This chapter includes several tips on how to prepare the laundry for washing.

LAUNDRY SORTING

Sort the laundry according to:

- how soiled it is,
- colour,
- material.

CLOTHING

































1. Close the zips and hook-and-loop fasteners so that they do not damage the fabric.
2. New dyed items may contain excess dye; therefore, they have to be washed separately several times.
3. Turn delicate items inside out. This will decrease the risk of tear and colour fading.
4. Place very sensitive clothes and small items in a special-purpose laundry washing bag. (The special purpose laundry bag is available as an optional accessory.)
5. Empty the pockets and turn them inside out.



LAUNDRY SYMBOLS

Observe the laundry symbols.

Textile maintenance symbols:

 Washing		
Normal		Delicate
	Max. washing temperature 90 °C	
	Max. washing temperature 60 °C	
	Max. washing temperature 40 °C	
	Max. washing temperature 30 °C	
	Hand wash only	
	Do not wash	
 Bleaching		
	Bleaching in cool water	
	Bleaching not allowed	
 Dry cleaning		
	Dry cleaning with all agents	
	Perchloroethylene R11, R113, petroleum	
	Dry cleaning in kerosene, pure alcohol, and R113	
	Dry cleaning not allowed	
 Ironing		
	Ironing with a hot iron with a maximum temperature of 200 °C	
	Ironing with a hot iron with a maximum temperature of 150°C	
	Ironing with a warm iron with a maximum temperature of 110°C	
	Ironing not allowed	
 Natural drying		
	Drying on a flat surface	
	Drying without prior spinning	
	Drying on a clothes line or a hanger	
 Tumble drying		
	Drying at high temperatures	
	Drying at low temperatures	
	Tumble drying not allowed	

DYED COTTON

Laundry made of dyed cotton which is to be washed at 60 °C should be first washed at a temperature of 60 °C to remove the excess dye. If this is not done, there is danger of dye being washed out of such items. To maintain the colour of the fabric, use bleach-free detergent.

UNBLEACHED LINEN

Unbleached lining fabric should be washed at 60 °C with a detergent free of bleach or optical bleaching agents. Heavily soiled linen laundry may be occasionally washed at higher temperatures, but do not do this too often as heat could ruin the sheen and strength of linen clothing.

WOOL

These fabrics are intended for either machine or hand wash. The Wool/Hand Wash program is equally gentle or even gentler than an actual hand wash.

Wool in particular is sensitive to washing and similar procedures.

If you do not wish to spin your clothes, select a setting without spinning (see "STEP 6: Choose the program settings /button 3"). However, most garments are suitable for at least a short spinning cycle. Top spinning speed available is 800 rpm.

VISCOSE AND SYNTHETIC FIBRES

Materials made of viscose and some synthetic fibres are highly sensitive, and require a lot of space in order not to crease. When washing, only fill the drum to a half and choose a program with spinning speed of no more than 1,000 rpm.



Viscose and acetates are fragile when wet.

REDUCING ALLERGIC REACTIONS

(Only in some models)

The options include washing with the Allergy Program Cotton and Allergy Program Synthetics, using the Allergy Mode program setting, or using an extra rinse (Super Rinse). These programs, program settings, and functions can be used for people with sensitive skin, such as those suffering from allergies, or small children.

SAVING TIME AND ENERGY

To save time and energy, use the Everyday Wash. This program has shorter main wash cycle than Standard Cotton and often suffices for less soiled laundry.

ECONOMY AND EFFICIENCY

You can save a lot of energy by not using the programs operating at higher temperatures. Choose the Quick program if you wish to only refresh the laundry; or use the Time program. This will save water and power.

Selecting the maximum spinning speed will reduce power consumption if you dry the clothes in a dryer or a drying cabinet. When using the programs Heavy, Everyday Wash and Standard Cotton, we recommend washing a full load.

Avoid prewash. Modern washing machines and detergents are efficient without the prewash as well. Prewash is only necessary for heavily soiled laundry. Use the additional function Prewash (see STEP 6: Program Settings Menu – choosing extra functions / button 5").

DETERGENTS

Detergents carrying the environment protection label are less harmful to the environment. Only add the detergents in compliance with the recommendations by detergent manufacturers.

Recommended amount of washing detergent at certain loads and water hardness levels are specified on the detergent packaging.

STAINS

If your clothes are soiled with stubborn stains (blood, eggs, coffee, grass etc.), they should be appropriately treated before the wash. Then, wash your laundry using the special programs (if your washing machine has them).

Do not use any chemical substances or agents; only use the stain removing detergents.

DYEING FABRICS

If you wish to dye fabrics in the washing machine, choose the Everyday Wash program with the Super Rinse extra function. Choose the temperature according to the dye manufacturer's recommendations. If you dye mixed fabrics, such as polyester/cotton, choose a low spinning speed.

Add the dye directly into the drum, rather than in the detergent compartment. After dyeing use the Drum Cleaning program (self-cleaning program). Use the standard amount of detergent.

When using bleaches or stain removal agents, there is danger of corrosion and discolouration.



To protect the environment, we recommend you avoid using powerful chemicals.

WASHING PROCESS, STEP BY STEP (1 – 8)

STEP 1: SORT THE LAUNDRY

See chapter "TIPS BEFORE WASHING"



Use a washing net for underwire bras. Empty the pockets. Coins, nails etc. could damage the machine and the fabric.

STEP 2: TURN ON THE MAIN SWITCH.



Turning on

Press the  on/off button.

Turning off

Press the  on/off button.

If the machine does not accept the on/off command correctly, wait for at least 8 seconds before pressing any other button.

STEP 3: OPEN THE WASHING MACHINE DOOR AND INSERT THE LAUNDRY.

Open the washing machine door by pulling the handle towards you.

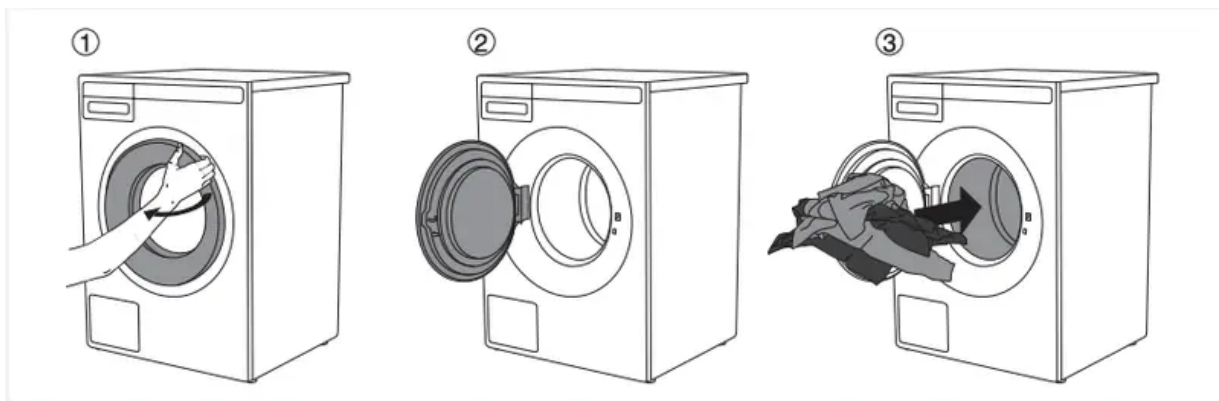

Place the laundry into the washing machine drum.

Before doing so, make sure the drum is empty.

Do not overload the drum!

If the washing machine drum is too full, the laundry will not be washed as thoroughly.

STEP 4: ADD THE DETERGENT AND THE CONDITIONER.

Recommended amount of detergent is usually specified on the detergent packaging. When washing a smaller amount of laundry, the amount of detergent used can be decreased. Observe manufacturers' recommendations regarding the type of detergent suitable for certain temperatures, load size, and water hardness.

Powder detergent

Add powder detergent into the main wash detergent compartment. If you have selected the Prewash function or Heavy program, Stain program Coffee or Fruit, or the Time program with 2:30 or longer duration, then add powder detergent to the prewash detergent compartment.



We recommend adding the powder detergent immediately before the washing cycle.

Otherwise, make sure the detergent compartment in the dispenser tray is completely dry before adding the powder detergent, as otherwise, the powder detergent may cake before the start of the washing process.

Liquid detergent

When using a liquid detergent, observe the detergent manufacturer's recommendations. When using thick detergents, we recommend always using the laundry balls. Use the barrier (3) in the detergent compartment; see figure in the chapter detergent tray. Add the liquid detergent in the front part of the detergent compartment in the dispenser tray (2).

Laundry ball or washing bag

If you are using a laundry ball or a washing bag, place it directly into the drum and choose a program without any prewash.



An excessive amount of detergent will not improve washing results. Rather, it will lead to foaming and increase the environmental impact. We recommend using less detergent. Only increase the dosage if you are not satisfied with the washing results.

Conditioner

Pour the conditioner into the dispenser tray, into the compartment with the symbol . Observe the recommendation on the conditioner packaging.



Do not fill the conditioner compartment over the max. indication (maximum indicated level). Otherwise, the conditioner will be added to the laundry too soon, leading to poorer washing effect.

STEP 5: CHOOSE THE PROGRAM.

Choose the program by rotating the Program selector knob in either direction.

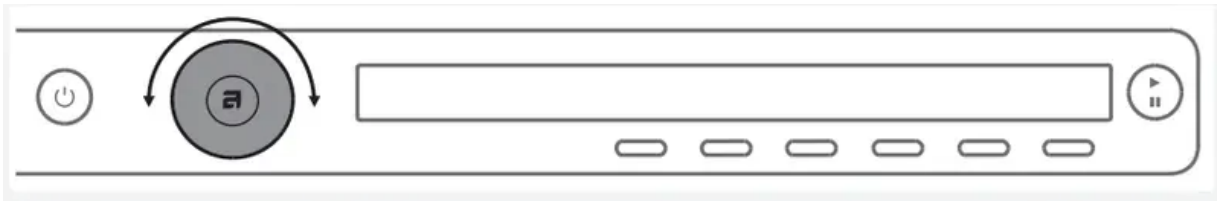

The Program selector knob can be used when arrows  appear on the display. Choose the program depending on the type of laundry and how heavily soiled it is (see chapter "TIPS BEFORE WASHING").

Estimated program duration will appear on the display.

Extra program settings can also be selected for each program. See STEP 6.

Choose between the following programs:

Program	Description
1. NORMAL	Program for normally or heavily soiled laundry, white or coloured. The temperature can be set separately; therefore, observe the instructions indicated on the clothing worn directly on the skin. Choose 40 °C if the laundry is only lightly dirty. Spinning speed can be set to your preference. Default setting is maximum spinning speed. Program duration and amount of water will be adjusted to the amount of laundry.
2. COTTON	Program for lightly to moderately dirty laundry. The temperature can be set separately; therefore, observe the instructions indicated on the clothing. Wash the clothes worn directly on the skin at 60 °C. Less heavily soiled laundry will be thoroughly cleaned at 40 °C. Spinning speed can also be freely selected. Default setting is maximum spinning speed. Program duration and amount of water will be adjusted to the amount of laundry
3. MIX/SYNTHETICS	Program for delicate clothing made of synthetic and mixed fibres or viscose, and for simple care of cotton. The highest available temperature is 60 °C. Observe the instructions indicated on the clothing. Most synthetic fabrics will be washed at 40 °C. Clothing worn directly on the skin should be washed at 60 °C. Maximum spinning speed is 1000 rpm; it can be decreased if necessary.
4. WOOL/HAND WASH	Gentle program for washing wool, silk, and clothes that require manual washing. Maximum temperature is 40 °C. This program has a short spinning cycle. Top spinning speed available is 800 rpm.
5. DARK WASH	This program is used for washing dark laundry using special-purpose detergents for black laundry. The program washes at low temperatures, with gentle tumbling and lower spin speed.
6. TIME PROGRAM	Use this program when you wish to wash the laundry for a specific amount of time. Duration can be set from 20 minutes to 3 hours (in 15-minute steps). In this program, select the corresponding washing time and temperature according to the type of laundry being washed.
7. AUTO PROGRAM (Auto)	This program automatically adjusts the duration of the main wash and number of rinses depending on the amount of laundry in the machine. No extra program settings are possible.
8. QUICK PROGRAM (Quick)	Quick program for laundry that only needs refreshing. The program operates at certain temperatures; therefore, observe the instructions



	indicated on the clothing. A lower temperature setting will result in shorter duration of the wash. Spinning speed can be set to your preference.
9. HEAVY	Program for heavily soiled laundry. Use the prewash option. The temperature can be set separately; therefore, observe the instructions indicated on the clothing. Maximum available temperature is 90 °C. It is suitable for very heavily soiled laundry. Spinning speed can be set to your preference. Program duration and amount of water will be adjusted to the amount of laundry.
10. RINSE	This program includes 2 cold rinse and a short spinning cycle. The program is suitable for laundry that only needs rinsing, and for cleaning cloths or mops.
11. SPINNING (Spin)	Use the program when you only wish to spin the laundry
12. DRAIN	If you only wish to pump out the water from the washing machine, choose the Drain program.
13. EASY CARE	Program for delicate clothing made of synthetic and mixed fibres, and for simple care of cotton. It may also be used for pillows, quilted jackets and similar items, as it uses a lot of water for the wash. Carefully read the washing instructions. If the outer layer has a membrane, do not use a conditioner. Washing temperature can be set up to 60 °C, and spinning speed can be set up to 1000 rpm.
14. DRUM CLEANING	This program is used to clean the drum and to remove detergent residues and bacteria. The drum has to be empty. Only add a small amount of powder detergent. You may also add a small amount of vinegar (approximately 2 dcl) or sodium bicarbonate “baking soda” (1 tablespoon or 15 g). Run this program at least once a month.
15. JEANS	Program for washing jeans. It uses low temperature and a low spin speed. Due to a higher water level and an extra rinse, there will be no traces of detergent on the jeans.
16. SHIRTS PROGRAM (Shirts)	This program washes the collars and cuffs without wrinkling them. The wash takes place at a low temperature, with a greater amount of water and gentle tumbling.
17. HYGIENE	This program is used to wash clothes that require special care, such as baby clothes or clothes for people suffering from skin allergies. The program is also suitable for washing bedding (against mites). We recommend turning the garments inside out as this will also

	thoroughly wash out the skin residues or residues of skin treatment products. The program is a combination of a heating and extra rinsing that removes any detergent residue.
18. BEDDING PROGRAM (Bedding)	This program is used to wash bedding, pillows, and larger items. Weekly wash of your bedding will remove skin residue and mites that cause allergies. Observe the instructions for washing and maintenance. The wash uses a large amount of water and extra rinse cycles.
19. ANTI-ALLERGY PROGRAM COTTON (Allergy program cotton)	This program is used to wash normal to heavily soiled clothes that require special care, such as clothes for people with highly sensitive skin or skin allergies. We recommend turning the garments inside out as this will also thoroughly wash out the skin and other residues. You can also select the option to wash at maximum temperature and maximum spinning speed.
20. ANTI-ALLERGY PROGRAM SYNTHETICS (Allergy program synthetics)	This program is used to wash clothes that require special care, such as clothes for people with highly sensitive skin or skin allergies. The program is also suitable for people sensitive to washing detergents. We recommend turning the garments inside out as this will also thoroughly wash out the skin and other residues.
21. QUICK PROFESSIONAL PROGRAM (Quick Pro)	Program for smaller amounts of lightly soiled laundry. The program washes with gentle tumbling and lower spin speed. (4 kg, 40 °C, 59 min)
22. SYSTEM SETTINGS	Use the program selector knob to choose System Settings and confirm with ENTER (button 2). Use the Program selector knob to scroll through the settings. The following options are available: <ul style="list-style-type: none"> – Child Lock, – Language (language selection), – Temperature (temperature unit), – Programs (set of programs), – Display (display unit: contrast & logo), – Sounds (acoustic signals), – Reset. See chapter "SYSTEM SETTINGS".

STEP 6: CHOOSING THE PROGRAM SETTINGS

Using the program settings, the washing programs can be further adjusted to your wishes. Some program settings may not be available for your selected program. Selected program settings will remain stored after the end of the washing cycle and may be changed subsequently (except for delayed start which is not stored after the wash is complete).

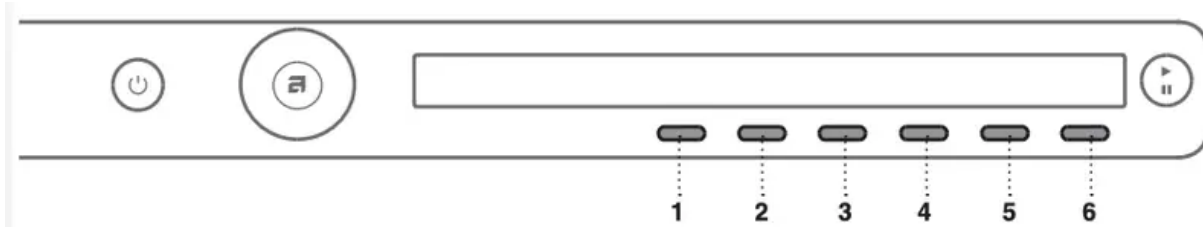

1. Washing mode
2. Temperature
3. Spin speed
4. Super Rinse
5. Additional program option (choosing extra functions)
6. Start delay

Choose the program settings before pressing the START button. Program settings cannot be changed during the progress of a program.



Press the button under the program setting to display the information (INFO) about the each program setting.

Following are the program settings that may be selected using the buttons 1 to 6:

1. Washing mode

By pressing the button 1, you can choose between washing modes:

- **Normal mode** (Basic setting)
- **Green mode** (Wash that saves energy; longer washing time, lower water consumption).
- **Speed Mode** (Time-saving wash; shorter washing times, higher water and energy consumption)

In the Cotton program, we recommend a half-load.

- **Allergy Mode** (Wash with extra water, extra rinsing, extended washing time, higher water and energy consumption).
- **Intense Mode** (Wash that improves cleaning performance, with extra water and extended washing time).

2. Temperature

By consecutively pressing the button 2, you can set the temperature for the selected program, choosing from the following available values:

Cold wash and 20/30/40/50/60/70/80/90 °C.

The actual available temperature options will depend on the selected program.

3. Spin speed

By consecutively pressing the button 3, you can set the spin speed, choosing from the following available values:

NO d (no drain) /... / max. (rpm) (max rpm = depends on the model)

Default setting is 1400 rpm; it depends on the selected program (spin rate can be changed – reduced or increased (only in some models)).

The actual available spin speed will depend on the selected washing program.



With the NO d (no drain) option, the program will not include a spin cycle, and the water from the last rinse will remain in the washing machine. The laundry will stay in the water from the last rinse, which will prevent creasing. If you have selected the No d (No Drain) option, you have to select the Drain or Spinning program after the end of the washing program to pump the water out from the machine before you open the washing machine door.

4. Super Rinse (extra rinses)





By pressing the button 4, you can switch the Super Rinse option on  or off (OFF). To increase the number of rinse cycles (+2), select the Super Rinse setting. This is recommended for persons with highly sensitive skin and/or in areas with very soft water. Availability of this setting will depend on the selected washing program.

5. Choosing extra functions (Additional program option)



Press the button 5 to confirm the extra functions. Then, use the Program selector knob to scroll the list of functions or options. Confirm the function you wish to select by pressing the button 1.

The following extra functions are available:



* Prewash

To use a prewash before the main wash, choose the Prewash option. Use of this function is recommended for heavily soiled laundry or for laundry with stubborn surface stains. Confirm the selection by pressing the button 1 (On  / Off ). To return to the main menu, press the button 6. Add the prewash detergent into the prewash compartment  and the main wash detergent into the main wash compartment  of the dispenser tray (see chapter "DISPENSER TRAY").

* High water level

For a larger amount of water after the wash and spinning cycle, select the High Water Level option. Confirm the selection by pressing the button 1 (On  / Off ). To return to the main menu, press the button 6.

* Anti-crease

If you do not want your laundry to crease during the wash or to be tumbled gently, choose the Anti-Crease option. This function is recommended for delicate laundry. Confirm the selection by pressing the button 1 (On  / Off ). To return to the main menu, press the button 6.



Some functions may not be available on all programs.

6. Start delay

Press the button 6 to choose the delayed start when you wish the washing program to start after a certain period of time (30´ to 24 hours after you press the Start button).

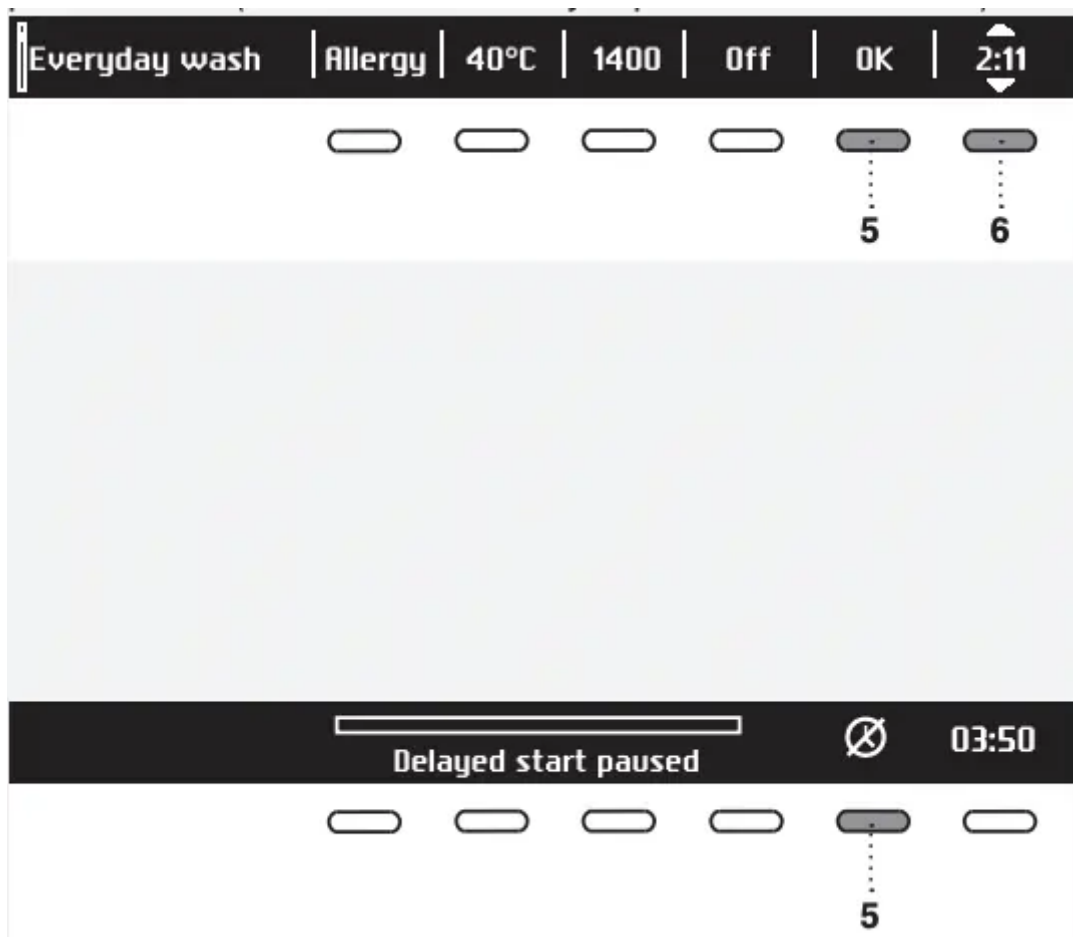

The estimated time remaining until the end of the washing program will be indicated above the button 6. Press the button 6 for the arrows  to appear.

Use the Program selector knob or the button 6 to set the delay from 30´ to 6 hours in 30-minute steps, and then from 6 hours to 24 hours in 1-hour steps. Press the button 5 (OK) to confirm your selection.

Press the Start  button to start. When the countdown reaches zero, the selected washing program will start automatically

To cancel the delay and start the washing process immediately, press the button .

To change the start delay time, press the Stop button and hold it for 3 seconds. Then, use the button 6 or the Program selector knob to set a new start delay time. After selecting the new delay time, press the Start button again.





If you have set the delayed start function, and you are using liquid detergent, we recommend setting a program without a pre-wash.

STEP 7: START THE WASH

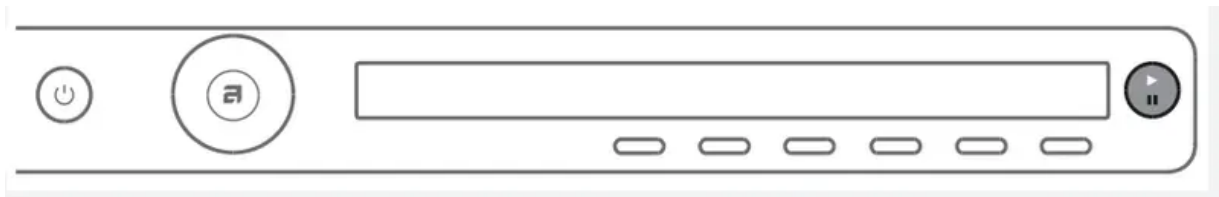
Close the washing machine door and press the Start/Pause/Stop button.



 Start (short press of the button – start/resume)

 Pause (short press of the button – pause) Stop (press and hold for 3 seconds – stop or cancel)

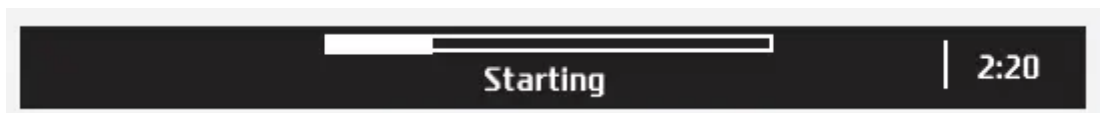

Remaining time

Depending on the selected program, anticipated washing time will be displayed in hours and minutes. Actual washing time will depend on the selected program, load, type of laundry, spin speed etc. Actual washing time may be longer or shorter than initially displayed. Remaining time will be updated during the program duration, depending on the actual amount of laundry and amount of water pumped into the machine. The last remaining time update takes place before the final spinning cycle.

In case of uneven distribution of laundry, the time on the display will flash and it will not count down. Once the laundry is evenly redistributed, the washing time will continue and it will stop flashing.



Adding or removing laundry after the start of the program

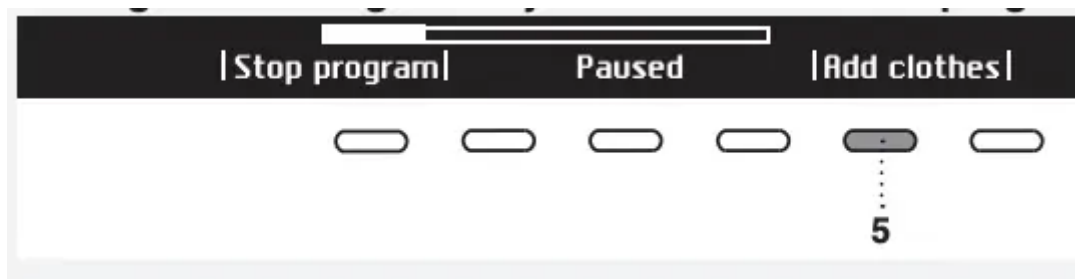

To add or remove laundry during the progress of a washing program, use the Pause  button to pause the program. Then, press the button 5 to select "Add clothes".

The door may be opened when the water is pumped from the machine. Then, add or remove the laundry. Close the door and continue the program. Press the Start  button. The program will resume from the point at which it was interrupted.

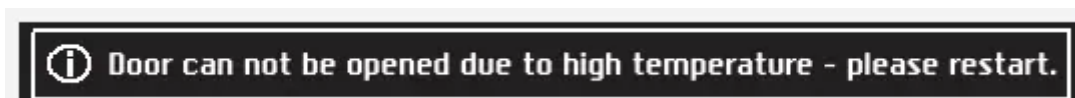

If the door cannot be opened, it is possible that the temperature in the machine is too high.

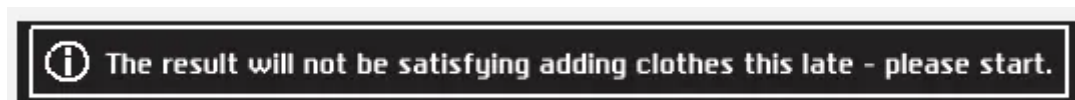

Also, if the door cannot be opened, it is possible that the program has been running for too long and any laundry added at that point would not be efficiently washed.

Pausing, stopping or changing the program

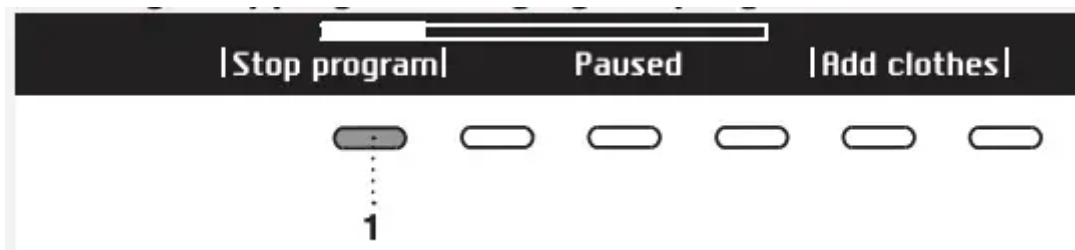

To pause the program, shortly press the Pause  button.

To resume a program, press the Start  button again.

To change or stop the washing program, press the Stop button and hold it for 3 seconds. Use the button 1 to choose "Stop program". The program is canceled and the water is pumped out of the machine if necessary. Only then will you be able to open the washing machine door. Use the

Program selector knob to select a new program. If necessary, add detergent, and then press the Start  button.

A washing program can be paused by pressing the ON/OFF button. The washing machine will switch off . After the washing machine is switched on, press the Start button to resume the program.



Do not open the detergent dispenser tray while the appliance is operating.

STEP 8: END OF PROGRAM



After the end of the washing program, the display will indicate that the program has been successfully completed ("Cycle completed successfully").



If you have selected the Anti-Crease extra function, gentle tumbling will continue after the end of the washing program in order to prevent creasing.

Open the door towards you and remove the laundry from the washing machine. Make sure the washing machine drum is empty.

If you do not take any action within 5 minutes after the end of the program, the display will switch off to standby mode in order to save power. The display will light up again if you press the ON/OFF button or open the washing machine door.



After the washing cycle, close the water intake and pull out the washing machine plug from the power socket.

Favourite programs



After the end of the program, you can use the button 6 to store the program, including all extra settings, as your favourite program.

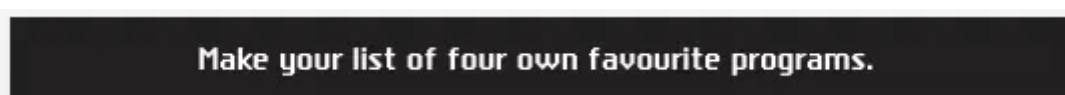

Up to 4 favourite programs can be stored.

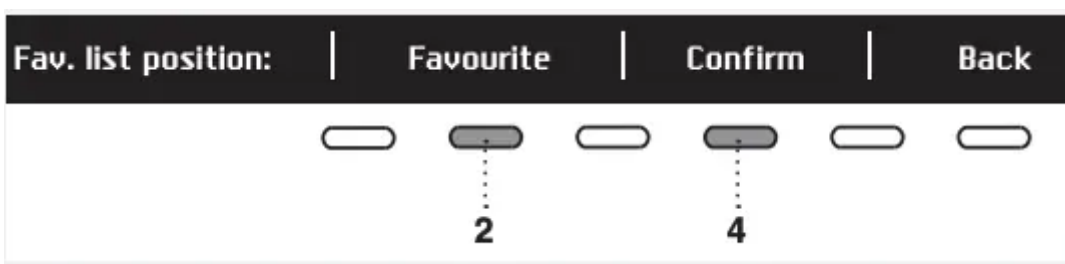

Choose the favourite program position (number) using the button 2; the most recently used program, including all settings, will be offered. To store a program, confirm with the button 4.

If you do not wish to store the program after the wash, rotate the Program selector knob and you will return to the program selection; or, simply open the washing machine door.

Changing a favourite program

If you wish to store a program after the end of the washing cycle, but there is no more room for another favourite program (only 4 favourite program slots are available), then one of the existing stored favourite programs can be substituted with a new one

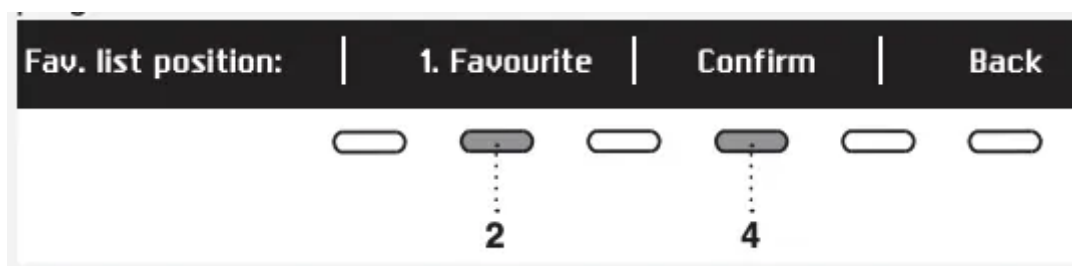

Use the button 2 to scroll through the list of Favourite programs. Press the button 4 to confirm the program to be replaced.

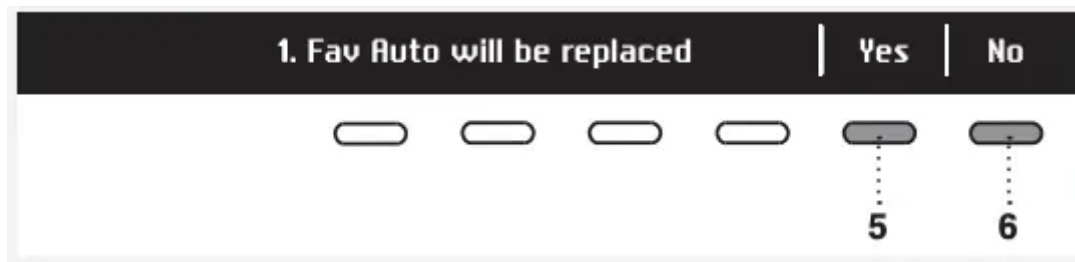

Confirm the replacement by pressing the button 5.

The list of favourite programs will appear when you switch on the washing machine.

If you do not take any action for 5 minutes, the display will switch to standby mode. To activate the display, press the ON/OFF button or open the washing machine door.

SYSTEM SETTINGS

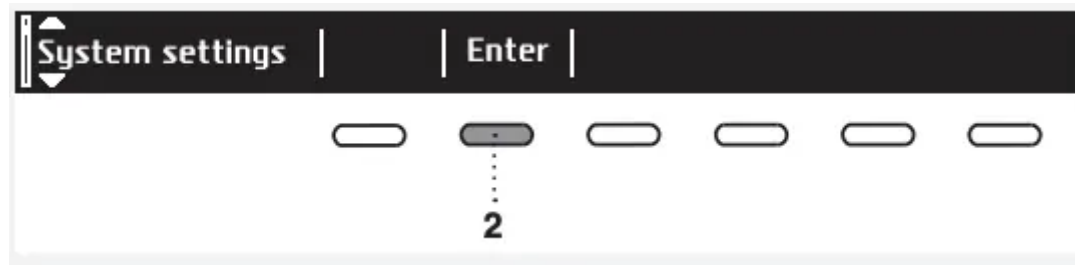

In the main menu, use the Program selector knob to select System Settings. Confirm the selection by pressing the button 2.

Then, use the Program selector knob to scroll the list of the following settings that you can adjust:

- Child Lock,
- Language (language selection),
- Temperature (temperature unit),
- Programs (set of programs),
- Display (display unit: contrast & logo),
- Sounds (acoustic signals),
- Reset.

Use the button 6 (BACK) to return to System Settings or to the main menu.

Press the INFO button to display brief information about the setting.

CHILD LOCK



Child lock can be activated by pressing the button 1 . This will prevent children from switching on the machine.





Press the button 1  to deactivate the child lock. When the child lock is activated, no other function can be selected.

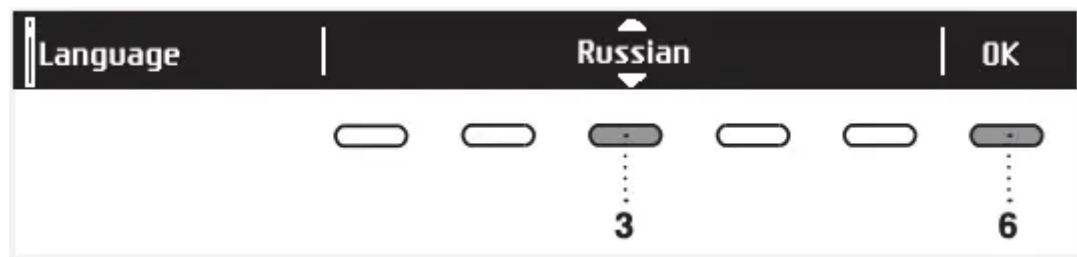

To temporarily (for 3 minutes) switch off the child lock, press the 1 and 4 buttons simultaneously and keep them pressed for 3 seconds.

LANGUAGE



You can choose between 25 languages. Press the button 3 for the arrows  to appear. Use the Program selector knob or the button 3 to scroll the list of languages. Use the button 6 to confirm the selected language.

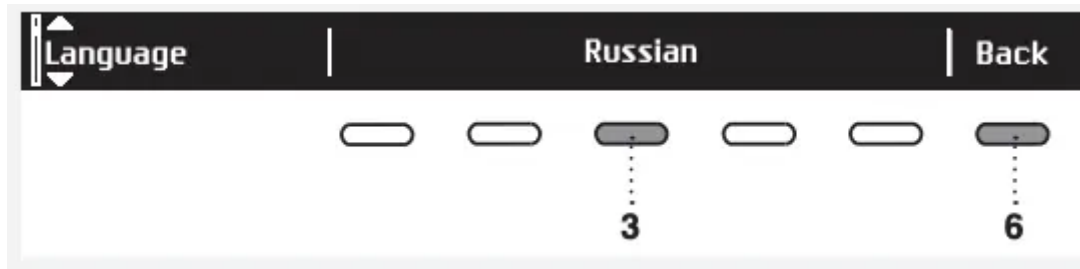

Use the button 6 to return to System Settings.

TEMPERATURE (TEMPERATURE UNIT)

Choose either °C or °F.

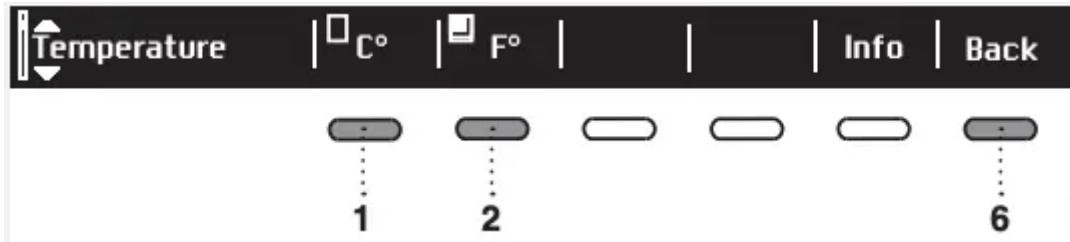

Use button 1 to select °C;



Use button 2 to select °F.

Use the button 6 to return to System Settings.

PROGRAMS

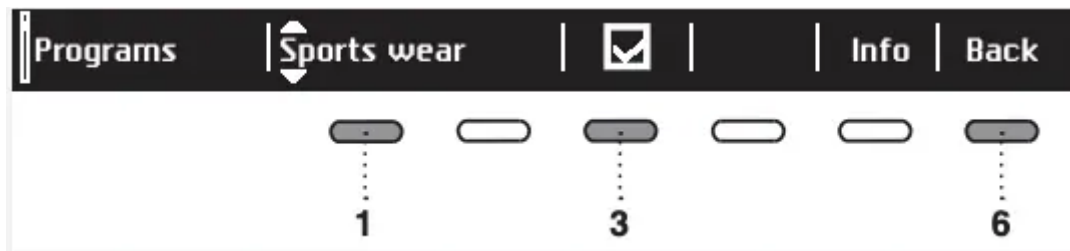
The main menu includes the entire set of programs that you can choose using the Program selector knob. This setting allows only displaying the selected program in the main menu.



Press the button 1 for the arrows  to appear. Use the Program selector knob or the button 1 to select a program. Use the button 3 to set whether this program is to be displayed or not: On  / Off .

Use the button 6 to return to System Settings.

DISPLAY UNIT

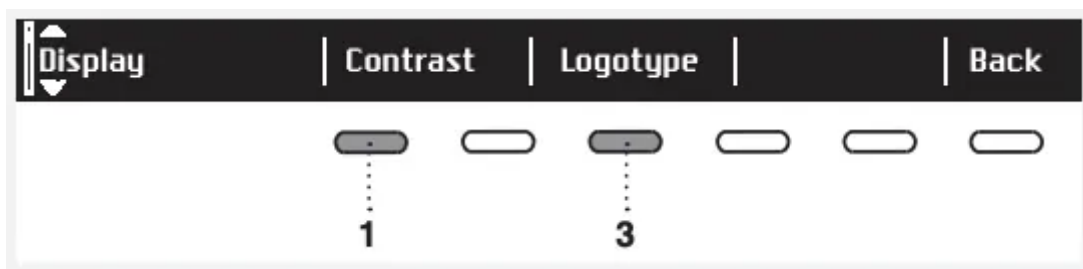

Set the contrast and logo display.

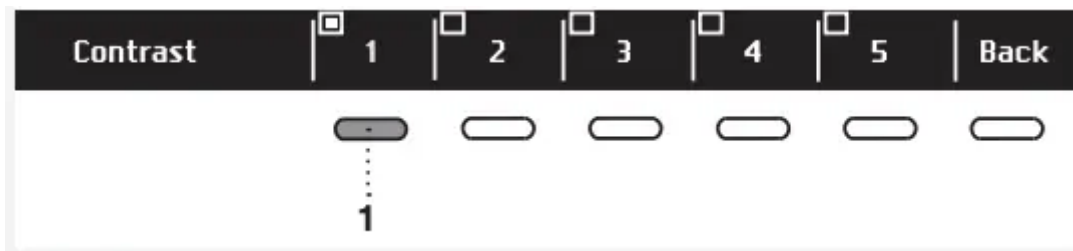

Use the buttons 1 to 5 to set the contrast.



Use the button 1 to toggle logo display on or off . If you choose on , the logo will be displayed on the display unit when the washing machine is turned on.

Use the button 6 to return to System Settings.

SOUNDS

Choose whether audible signals are switched on or off.

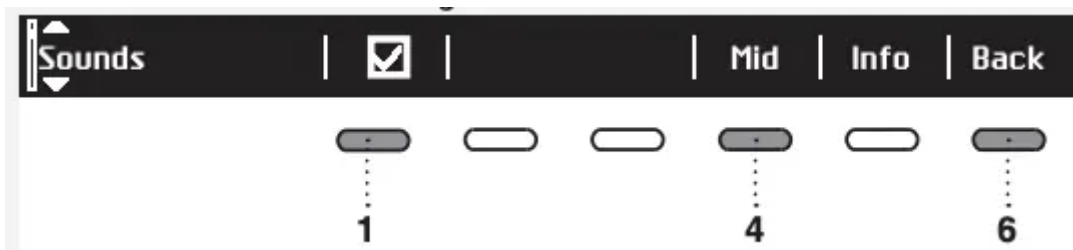

Use the button 1 to switch acoustic signal on or off . Use the button 4 to choose between the following settings: low, mid, and high. As you scroll through the options, a sample audible signal will be sounded.

Use the button 6 to return to System Settings.

RESET

This means that all settings will return to the default settings and your own settings will be deleted

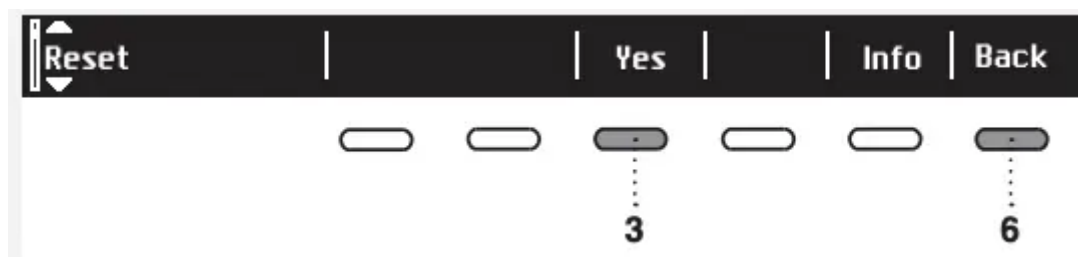

Confirm the selection by pressing the button 3 (YES).

Use the button 6 to return to System Settings.

CLEANING AND MAINTENANCE

CLEANING THE FILTER

The washing machine has a filter that will retain smaller objects such as coins, buttons, hair etc.

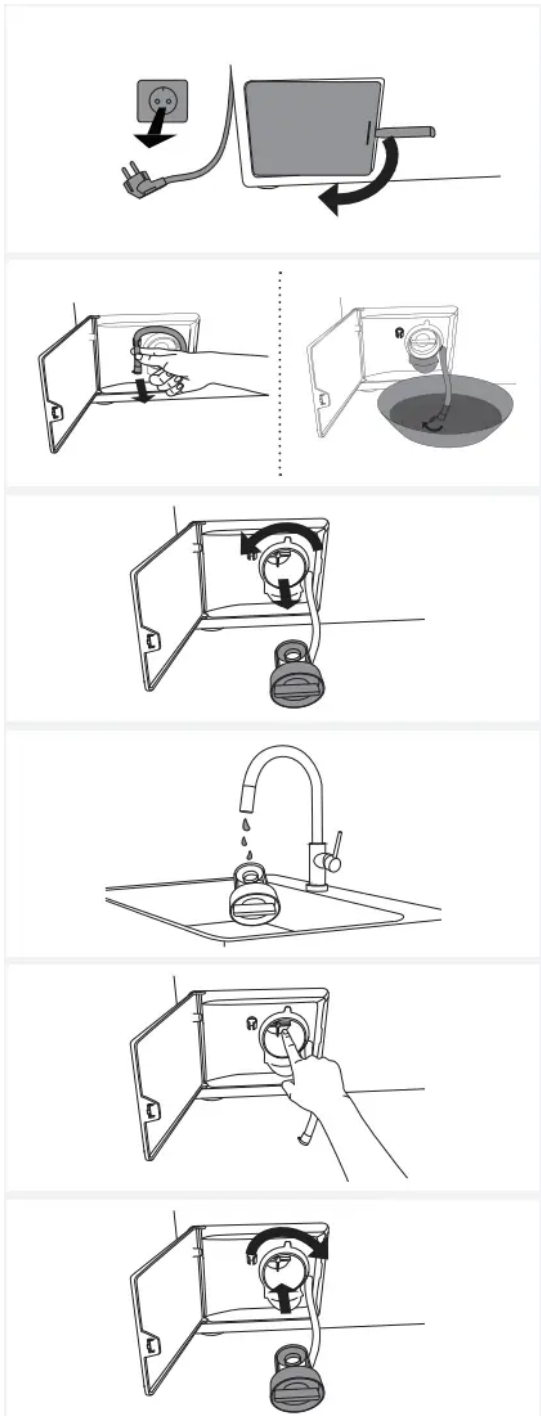

1 Before cleaning, drain the water from the washing machine using the Drain program, and disconnect the washing machine from the power mains. Open the pump filter cover using appropriate tools. Open the pump filter cover using appropriate tools (emergency door opening tool is located on the back side of the dispenser).

2 Release the water drain hose from the holder. Before cleaning the filter, drain the water from the washing machine by placing the end of the water drain hose over a large shallow container and opening the cap on the water drain hose.

3 Gradually rotate the filter in the counter-clockwise direction and pull it out.

4 Clean the filter thoroughly under running water.

5 Remove all objects and impurities from the filter housing and the impeller.

6 Replace the filter as shown in the figure and fasten it by rotating in the clockwise direction. For a good seal, the filter seal surface should be clean. Also re-install the drain hose.

CLEANING THE DISPENSER TRAY AND DOOR RUBBER GASKET

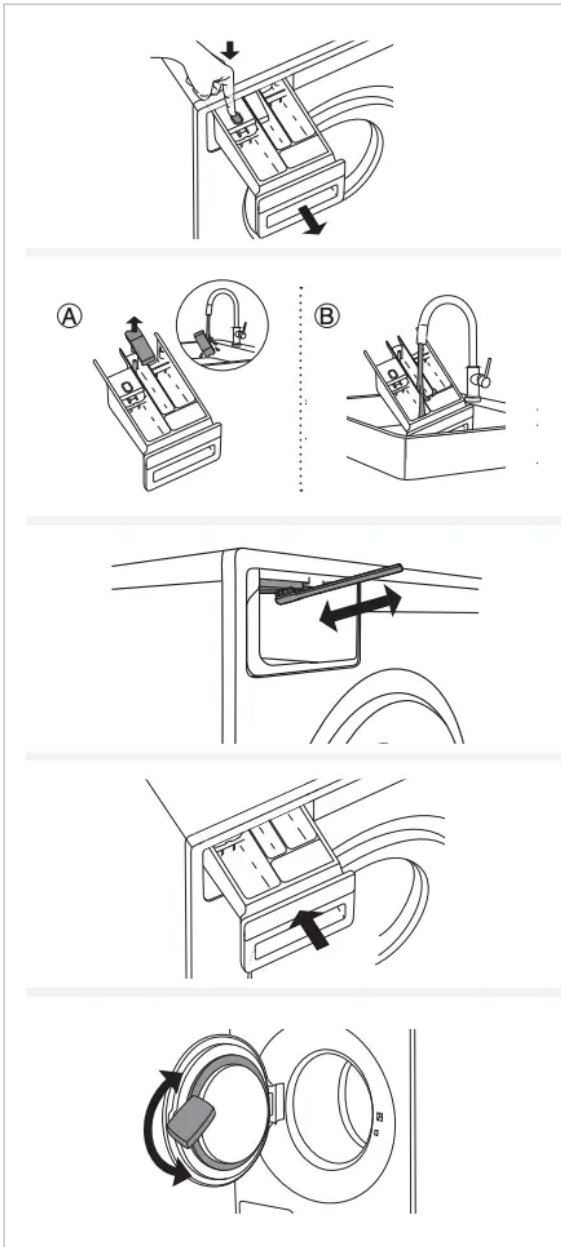

1 Press the tab to completely remove the dispenser tray from its housing. A B

2 Rinse and thoroughly clean the tray. You may also remove the cap from the plug in the conditioner compartment (A). Clean any residue from the cap and tube. Clean the dispenser tray (B) interior. Replace the cap on the plug.

3 Use a brush to clean the nozzles on the upper side of the dispenser tray housing. After a washing program, nozzles that clean the interior of the dispenser are automatically switched on (only with some models).

4 Replace the detergent dispenser into its housing.



Close the dispenser tank!



Do not wash the dispenser tank in the dishwasher!

5 After every wash, wipe the rubber door seal to extend its useful life.

CLEANING THE APPLIANCE EXTERIOR

Wipe the washing machine exterior and the display unit using a soft damp cotton cloth and mild detergent. Do not use any solvents or cleaning agents that could damage the washing machine (please observe the recommendations and warnings provided by the manufacturers of the cleaning agents).



Do not clean the washing machine with a jet of water!

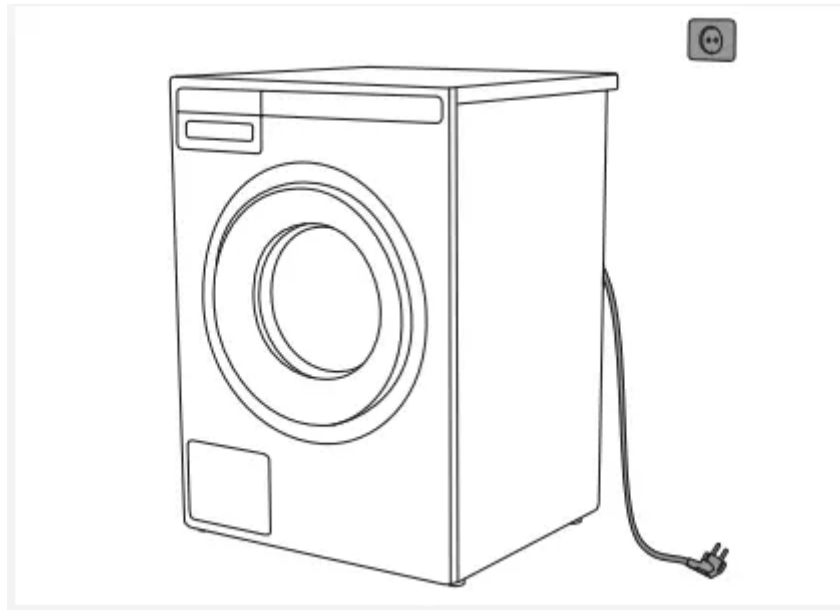

Always disconnect the washing machine from the power mains before cleaning.

CLEANING THE WASHING MACHINE INTERIOR AGAINST ODOURS

Modern detergents often allow washing clothes at low temperatures. This means that residue may accumulate in the washing machine, which in turn could cause odours. To avoid such odours, we recommend running the self-cleaning program (Drum-cleaning) once per month. Use a small amount of powder detergent and do not put any laundry in the drum.

CLEANING THE RINSING HOLES (UNDER THE AGITATOR IN THE DRUM)

If you believe that objects like nails or paper clips fell into the washing machine drum, check the area underneath the rib. Such objects may rust (corrode) and cause stains on your clothes. Nails and other sharp objects can also cause holes in the fabric.

Proceed as follows:

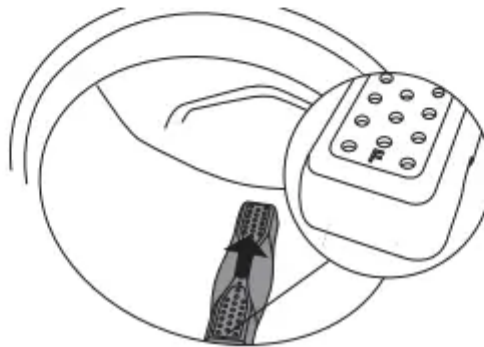

1. Insert a screwdriver or a similar tool into the slot in the rib and carefully push it to the left.
2. Hold the rib with the other hand and pull it towards you.
3. Lift the drum rib.
4. Remove any objects.
5. Place the rib into the installation slot indicated with "F" towards you. Make sure all ribs are firmly in place in their respective slots in the drum. Push the rib inwards (as indicated by the arrow in the figure) until it snaps.

If you are using hard water

If you are washing with hard water (causing limescale build-up), a greyish-white film may appear on the washing machine drum. To remove this film, add vinegar into the washing machine drum

and select any program with a temperature of 90 °C, or the Drum Cleaning program. See STEP 5: Choose the program. Repeat the process as necessary



ERRORS – WHAT TO DO?

Disturbances from the environment (e.g. the power grid) may result in various error reports (see Troubleshooting table). In such case:

- Switch off the appliance, wait for 1 minute, switch the appliance back on, and repeat the washing program.
- If the error persists, call an authorized service unit.
- You will be able to solve most of the problems in appliance operation by yourself (see Troubleshooting table below).
- Repairs may only be carried out by an adequately trained person.
- Repair or any warranty claim resulting from incorrect connection or use of the washing machine shall not be covered by the warranty. In such cases, the costs of repair shall be charged to the user.



The warranty does not cover the errors or failures resulting from disturbances from the environment (lightning strike, power grid failures, natural disasters etc.).

Problem/error	Cause	What to do?
Washing machine door does not open.	Water level too high.	Drain the water using the Drain or Spinning program. See "Step 5: Choose the program".
	Water temperature in the washing machine is too high.	Wait for the water temperature to drop and pump out the water. If you still cannot open the door, use the emergency door opening tool (see chapter "ERRORS – WHAT TO DO? / Manual opening of washing machine door").
The machine will not start.	Power supply failure.	Press the Start  button to resume the program.
Washing program is not in progress.	Washing machine door is not properly closed.	Firmly press on the washing machine door until you hear two clicks when it is closed.
	There is no voltage in the power outlet.	Check if the plug is connected to the power outlet and whether there is electric current (or voltage) in the outlet.
	Delayed start function has been selected.	To cancel the delayed start function, press the Start  button and hold it for three seconds.
Washing time is longer than anticipated (the time is regularly updated on the display unit).	Low inlet water temperature.	Program duration can be up to 60% longer than initially anticipated in the normal progress.
	UKS* (*unbalance system) stability system engaged due to unevenly distributed laundry.	Program time is extended due to the need to redistribute the laundry in the drum.
	Low mains voltage.	Washing machine needs more time because the power mains voltage is too low.
	Power supply failure.	Program time is extended by the duration of the power supply failure.

Display does not light up.	There is no voltage in the appliance.	Check if the plug is connected to the power outlet and whether there is electric current (or voltage) in the outlet.
The wording on the display unit is not in your language.	You have not selected your preferred language yet.	Choose the preferred language (see "STEP 5 / System Settings / Choosing the language").
Wet laundry	A small amount of laundry will often be unevenly distributed.	<ul style="list-style-type: none"> • Loosen and redistribute the laundry and select the Drain or Spinning program. • Increase the amount of laundry in the washing machine and restart the program (see "STEP 7: Start the wash / Adding or removing laundry after the start of the program").
There are traces of grease (or grease rolls) on the clothes.	The laundry was very greasy	Wash the laundry again. When your laundry is this heavily soiled, add more washing powder or use a liquid detergent.
There are still stains on the laundry	You used bleach-free liquid detergent or powder detergent for coloured laundry.	Use a detergent that contains bleach.
	You selected an unsuitable program.	Use special stain removers.
There are white residues of washing powder on the laundry.	This is not due to poor rinsing by your washing machine, but rather due to phosphatefree detergents which contain ingredients (zeolites) for water softening. These ingredients may be deposited on the laundry.	<ul style="list-style-type: none"> • Immediately rinse the laundry again. • Use liquid detergents that do not contain zeolites. • Try removing any residues with a brush.
There is powder detergent left in		Clean the net on the water supply hose.

the main wash compartment of the detergent dispenser tray.	Water pressure not high enough.	
	Some washing powders may stick strongly to the dispenser tray if it is empty	<ul style="list-style-type: none"> • Choose higher water level or extra rinse (see "Step 6 / Choose program settings"). • Wipe the dispenser tray before adding the powder detergent.
There is conditioner left in the conditioner compartment of the dispenser tray.	Plug cap is not positioned correctly or it is clogged.	<ul style="list-style-type: none"> • Make sure the plug cap in the conditioner compartment of the dispenser tray is positioned correctly. • Clean the plug cap (see chapter "CLEANING AND MAINTENANCE / Cleaning the dispenser tray").
Odour in the washing machine drum.	Residues of fabric, washing detergent, and conditioner in the filter.	Check if the filter is clean.
	Development of germs and bacteria.	Choose a self-cleaning (Drum Cleaning) program (see "STEP 5: Choose the program").
Machine is moving during operation.	Feet not adjusted correctly	Level the feet (see chapter "INSTALLATION AND CONNECTION / Adjusting the feet").
	Transport bolts not removed.	Remove the transport bolts (see chapter "BEFORE USING THE APPLIANCE FOR THE FIRST TIME / Transport protection").
Machine is moving during spinning.	Unevenly distributed laundry or not enough laundry	<ul style="list-style-type: none"> • The washing machine will automatically decrease the spin speed if vibration is too strong. • Increase the amount of laundry in the washing machine and restart the program (see "STEP 7: Start the wash / Adding or

removing laundry after the start of the program").

Manual opening of washing machine door

Washing machine door may be opened manually if the appliance is not connected to the power mains and if the water has been pumped out of the machine.

- A. Choose the Spinning or Drain program to pump the water from the machine. If this does not work, water has to be drained from the washing machine drum manually. See chapter "Cleaning the trap and drain pump" in the chapter "CLEANING AND MAINTENANCE".
- B. Make sure the main switch is off and that the plug is disconnected from the power outlet.
- C. Take the emergency door opening tool (found at the back of the dispenser) and insert it into the upper part of the slot on the right-hand side of the washing machine door latch.

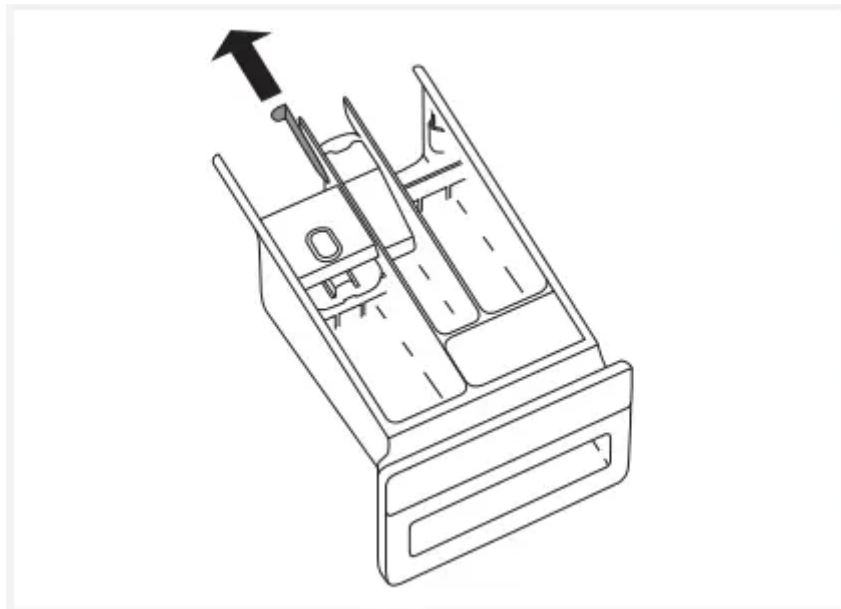

- D. Press the key (key=the emergency door opening tool) downwards (all the way, until you hear a click) to unlock the washing machine door. When the door is unlocked, open it by pulling towards you.

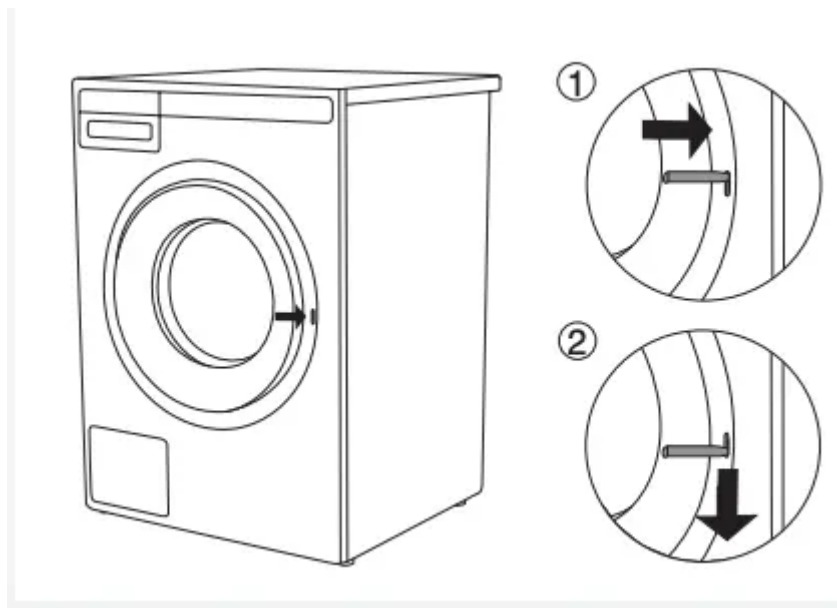

If the washing machine door still cannot be opened, call a service technician.

FAILURE DISPLAY

In case of a failure while a program is in progress, the relevant Error X is indicated on the display unit.

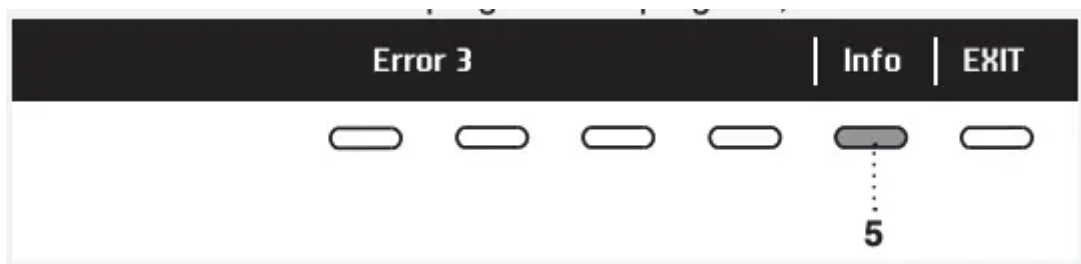

Press the INFO button to display the error description.

Switch off the appliance and turn it back on.

Errors indicated on the display unit may include the following:

Error	Error indication on the display unit	What to do?
E1	THERMISTOR ERROR Temperature sensor error.	<ul style="list-style-type: none"> • Inlet water too cold. Repeat the washing program. • If the appliance reports this error again, call a service technician.
E2	DOOR LOCK ERROR	Restart the program. If the error reoccurs, call a service technician.
E3	WATER FILLING ERROR	<p>Check the following:</p> <ul style="list-style-type: none"> • is the water inlet valve open, • is the filter on the water inlet hose clean, • is the water supply hose deformed (clipped, clogged etc.). <p>Then, press the START button to resume the program. If the error reoccurs, call a service technician.</p>
E6	HEATING ERROR Water heating error	Restart the program. If the error reoccurs, call a service technician.
E7	DRAINING ERROR Water draining error.	<p>Check the following:</p> <ul style="list-style-type: none"> • is the pump filter clean, • is the drain hose clogged, • is the drain clogged, • is the drain hose fitted at the right height (see chapter on drain hose installation in the instruction manual). <p>Then, press the Start button again. If the error reoccurs, call a service technician.</p>
E7.1	DRAIN SYSTEM ALERT Water drain system alert.	<p>Alert about reduced water flow in the pumping stage. Check the following:</p> <ul style="list-style-type: none"> • is the pump filter clean, • is the drain hose clogged, • is the drain clogged,

		<ul style="list-style-type: none"> • is the drain hose fitted at the right height (see chapter on drain hose installation).
E10	WATER LEVEL SENSOR ERROR	Restart the program. If the error reoccurs, call a service technician.
E11	OVERFLOW Water overflowing.	Restart the program. If the error reoccurs, call a service technician.
E12	MOTOR ERROR	Restart the program. If the error reoccurs, call a service technician.
E22	DOOR LOCK ERROR Error while locking the door.	Door is closed, but it cannot be locked. Close the door again. Turn the washing machine off, then restart the washing program. If the error reoccurs, call a service technician.
E23	DOOR UNLOCK ERROR Error while unlocking the door.	Door is closed, but it cannot be unlocked. Turn off the washing machine, then turn it back on. If the error reoccurs, call a service technician. See instructions for opening the door – chapter on manual door opening.
E36	COMMUNICATION UI AND PMCU Error in UI and PMCU communication	Turn off the appliance and turn it back on. If the error reoccurs, call a service technician.
	UNBALANCE Unevenly distributed laundry	Manually distribute the laundry and run the spinning program.
	STERIL TUB ALERT Warning – Self-cleaning program	Use the self-cleaning program (DRUM CLEANING); see STEP 5.

Unevenly distributed laundry or lumps of laundry in the washing machine drum may cause problems such as vibration and noisy operation. The washing machine will sense this and activate the UKS* (*unbalance system).

Smaller loads (e.g. one towel, one sweater, one bathrobe etc.) or clothes made of materials with special geometrical properties are virtually impossible to distribute evenly across the washing machine drum (slippers, large items etc.). This results in several attempts to redistribute the laundry, which in turn leads to longer program duration. In extreme cases of unfavourable conditions, the program can be completed without the spinning cycle.

UKS* (*unbalance system) allows stable operation and extends the useful life of the appliance.

Warning

This content is compiled from multiple sources and is provided for reference purposes only. It may not be complete or fully applicable to all situations. If you are unable to resolve your issue, please contact the product manufacturer or an authorized service provider for official support.